

PARSONS

150 Federal Street • Boston, Massachusetts 02110 • (617) 946-9400 • Fax: (617) 946-9777 • www.parsons.com

April 14, 2006

Mr. John Nohrstedt
U.S. Army Corps of Engineers
Engineering and Support Center, Huntsville
Attn: CEHNC-FS-IS
4820 University Square
Huntsville, Alabama 35816-1822

Subject: Submittal of Draft Final Phase II Remedial Investigation for SEAD-59 and SEAD-71 at Seneca Army Depot Activity, Contract DACA87-02-D-0005, Delivery Order 0013

Dear Mr. Nohrstedt:

Parsons is pleased to submit the Draft Final Phase II Remedial Investigation Report for SEAD-59 and SEAD-71 at the Seneca Army Depot Activity located in Romulus, New York. In addition to the enclosed report, the report is being submitted electronically.

The Phase II Remedial Investigation Report was prepared in accordance with the Scope of Work for Delivery Order 0013 under Contract DACA87-02-D-0005. Parsons has incorporated the Army's comments on the Draft Phase II Remedial Investigation Report and the response to the comments is attached.

Parsons appreciates the opportunity to provide the Army with this document. Should you have any questions about the material presented in this document, please do not hesitate to call me at (617) 449-1405 to discuss them.

Sincerely,



Todd Heino, P.E.
Program Manager

Enclosure

cc: S. Absolom, SEDA
C. Boes, USAEC

K. Hoddinott, USACHPPM
J. Fallo, USACE, NY District



PARSONS

150 Federal Street • Boston, Massachusetts 02110 • (617) 946-9400 • Fax: (617) 946-9777 • www.parsons.com

April 14, 2006

Mr. Julio Vazquez
USEPA Region II
Superfund Federal Facilities Section
290 Broadway, 18th Floor
New York, NY 10007-1866

Mr. Kuldeep K. Gupta, P.E.
New York State Department of Environmental Conservation (NYSDEC)
Division of Environmental Remediation
Remedial Bureau A, Section C
625 Broadway
Albany, NY 12233-7015

Ms. Charlotte Bethoney
Bureau of Environmental Exposure Investigation
Flanigan Square, Room 300
547 River Street
Troy, New York 12180

**Subject: Submittal of Draft Final Phase II Remedial Investigation for SEAD-59 and
SEAD-71 at Seneca Army Depot Activity, Contract DACA87-02-D-0005, Delivery
Order 0013**

Dear Mr. Vazquez/Mr. Gupta/Ms. Bethoney:

Parsons is pleased to submit the Draft Final Phase II Remedial Investigation Report for SEAD-59 and SEAD-71 at the Seneca Army Depot Activity located in Romulus, New York (EPA Site ID# NY0213820830 and NY Site ID# 8-50-006). The Phase II Remedial Investigation Report was prepared in accordance with the Scope of Work for Delivery Order 0013 under Contract DACA87-02-D-0005. In addition to the enclosed report, the report is being submitted electronically.

Should you have any questions about the material presented in this document, please do not hesitate to call me at (617) 449-1405 to discuss them.

Sincerely,



Todd Heino, P.E.
Program Manager

Enclosures

cc: J. Nohrstedt, USACE, Huntsville
 K. Hoddinott, USACHPPM
 J. Fallo, USACE, NY District

S. Absolom, SEDA
C. Boes, USAEC
J. Fellingner, Contractor for USEPA





Seneca Army Depot Activity
Romulus, NY

US Army, Engineering & Support Center
Huntsville, AL

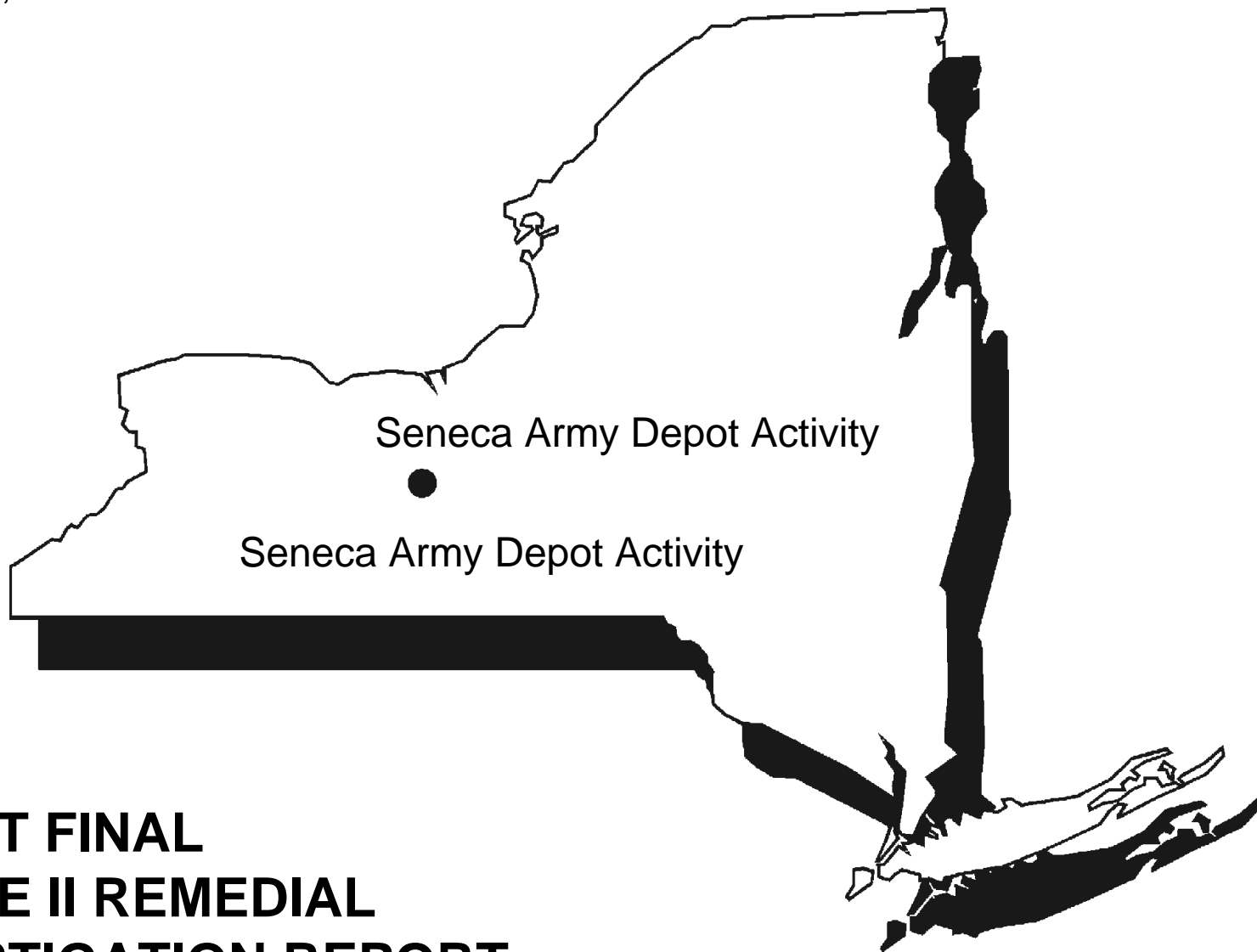

DRAFT FINAL PHASE II REMEDIAL INVESTIGATION REPORT

**FILL AREA WEST OF BUILDING 135 (SEAD-59)
AND THE ALLEGED PAINT DISPOSAL AREA (SEAD-71)**

EPA Site ID# NY0213820830
NY Site ID# 8-50-006
CONTRACT NO. DACA87-02-D-0005
DELIVERY ORDER NO. 0013

Volume I & II

APRIL 2006

DRAFT FINAL

**PHASE II REMEDIAL INVESTIGATION REPORT
FOR THE FILL AREA WEST OF BUILDING 135 (SEAD-59)
AND THE ALLEGED PAINT DISPOSAL AREA (SEAD-71)
SENECA ARMY DEPOT ACTIVITY
ROMULUS, NEW YORK**

Prepared For:

**Seneca Army Depot Activity
and
U.S. Army Corps of Engineers
Huntsville Center**

Prepared By:

**Parsons
150 Federal Street
Boston, Massachusetts**

**Contract No. DACA87-02-D-0005
Delivery Order No. 13**

April 2006

TABLE OF CONTENTS

<u>Section</u>	<u>Page</u>
Table of Contents	i
List of Tables	viii
List of Figures	x
List of Appendices	xi
List of Acronyms.....	xii
List of References.....	xvi
EXECUTIVE SUMMARY	E-1
E.1 NATURE AND EXTENT OF IMPACT	E-1
E.1.1 Nature and Extent of Impact of SEAD-59.....	E-1
E.1.2 Nature and Extent of Impact of SEAD-59 Stockpile	E-2
E.1.3 Nature and Extent of Impact of SEAD-71.....	E-3
E.2 CONTAMINANT FATE AND TRANSPORT	E-4
E.3 HUMAN HEALTH RISK ASSESSMENT.....	E-4
E.3.1 SEAD-59 Human Health Risk Assessment.....	E-5
E.3.2 SEAD-59 Stockpile Human Health Risk Assessment	E-5
E.3.3 SEAD-71 Human Health Risk Assessment.....	E-6
E.4 SCREENING-LEVEL ECOLOGICAL RISK ASSESSMENT	E-7
E.4.1 SEAD-59 SLERA	E-8
E.4.2 SEAD-59 Stockpile SLERA.....	E-9
E.4.3 SEAD-71 SLERA	E-10
E.5 RECOMMENDATIONS	E-11
1.0 INTRODUCTION	1-1
1.1 REPORT ORGANIZATION	1-1
1.2 SENECA ARMY DEPOT PROJECT BACKGROUND	1-1
1.3 SEAD-59/71 SITE BACKGROUND	1-2
1.3.1 SEAD-59	1-2
1.3.2 SEAD-71	1-3
1.4 ENVIRONMENTAL SETTING	1-4
1.4.1 Geology	1-4
1.4.2 Hydrogeology	1-7
1.4.3 Regional/Local Land Use.....	1-11
1.4.4 Regional Topography	1-12
1.4.5 Regional Climate.....	1-12
1.5 OFF-SITE WELL INVENTORY	1-14

2.0	SUMMARY OF PREVIOUS INVESTIGATIONS	2-1
2.1	APPLICABLE OR RELEVANT AND APPROPRIATE REQUIREMENTS (ARARS)	2-1
2.2	EXPANDED SITE INVESTIGATION	2-2
2.2.1	ESI Activity Summary	2-2
2.2.2	Summary of ESI Results	2-3
2.2.2.1	Summary of SEAD-59 ESI Results	2-3
2.2.2.2	Summary of SEAD-71 ESI Results	2-4
2.3	PHASE I REMEDIAL INVESTIGATION	2-4
2.3.1	Phase I Remedial Investigation Activity Summary	2-5
2.3.2	Summary of Phase I Remedial Investigation Results	2-5
2.3.2.1	Summary of SEAD-59 Phase I Remedial Investigation Results.....	2-5
2.3.2.2	Summary of SEAD-71 Phase I Remedial Investigation Results.....	2-6
2.4	TIME-CRITICAL REMOVAL ACTION	2-7
2.4.1	Purpose of Time-Critical Removal Action	2-7
2.4.2	Summary of Time-Critical Removal Action	2-8
2.4.3	Time-Critical Removal Action Sample Collection and Designation.....	2-9
2.4.4	Additional Groundwater Monitoring Well Installation.....	2-11
3.0	POST-TCRA INVESTIGATIONS AND DATA EVALUATION	3-1
3.1	TCRA DATA EVALUATION	3-1
3.1.1	TCRA Data Validation Protocol	3-1
3.1.2	Overall Summary of Data Usability and Qualifiers	3-2
3.1.3	Precision	3-3
3.1.4	Accuracy	3-3
3.1.5	Representativeness	3-4
3.1.5.1	Sample Package Completeness and Deliverables.....	3-5
3.1.5.2	Sample Preservation and Technical Holding Time	3-5
3.1.5.3	Other QA/QC Results	3-5
3.1.5.4	Laboratory Difference	3-5
3.1.6	Protocol for Using Duplicate Results	3-6
3.2	DETERMINATION OF DATASET USED TO EVALUATE CURRENT SEAD-59 AND SEAD-71 CONDITIONS	3-6
3.2.1	Determination of the Use of Historical Samples	3-7
3.2.2	SEAD-59 Dataset	3-8
3.2.3	SEAD-71 Dataset	3-8
3.2.4	SEAD-59 Stockpile Data	3-9
3.3	GROUNDWATER INVESTIGATION	3-9
3.3.1	Groundwater Sampling Procedures	3-10
3.3.2	Groundwater Sampling Analysis	3-11
3.3.3	Groundwater Levels	3-12

3.3.4	Groundwater Data Validation	3-12
4.0	NATURE AND EXTENT OF IMPACTS	4-1
4.1	ARARS AND TBCS	4-1
4.2	SEAD-59: NATURE AND EXTENT OF IMPACTS	4-2
4.2.1	Surface Soil	4-2
4.2.1.1	Volatile Organic Compounds	4-2
4.2.1.2	Semivolatile Organic Compounds (SVOCs)	4-3
4.2.1.3	Pesticides and PCBs	4-3
4.2.1.4	Metals	4-3
4.2.1.5	Total Petroleum Hydrocarbons	4-4
4.2.2	Subsurface Soil	4-5
4.2.2.1	Volatile Organic Compounds	4-5
4.2.2.2	Semivolatile Organic Compounds (SVOCs)	4-5
4.2.2.3	Pesticides and PCBs	4-5
4.2.2.4	Metals	4-5
4.2.3	SEAD-59 Groundwater	4-6
4.2.3.1	Volatile Organic Compounds	4-6
4.2.3.2	Semivolatile Organic Compounds (SVOCs)	4-7
4.2.3.3	Pesticides and PCBs	4-7
4.2.3.4	Metals	4-8
4.3	SEAD-59 STOCKPILE SOIL: NATURE AND EXTENT OF IMPACTS	4-8
4.3.1	Volatile Organic Compounds	4-9
4.3.2	Semivolatile Organic Compounds (SVOCs)	4-9
4.3.3	Pesticides and PCBs	4-9
4.3.4	Metals	4-10
4.4	SEAD-71: NATURE AND EXTENT OF IMPACTS	4-10
4.4.1	Surface Soil	4-10
4.4.1.1	Volatile Organic Compounds	4-11
4.4.1.2	Semivolatile Organic Compounds (SVOCs)	4-11
4.4.1.3	Pesticides and PCBs	4-12
4.4.1.4	Metals	4-12
4.4.1.5	Total Petroleum Hydrocarbons	4-13
4.4.2	Subsurface Soil	4-13
4.4.2.1	Volatile Organic Compounds	4-14
4.4.2.2	Semivolatile Organic Compounds (SVOCs)	4-14
4.4.2.3	Pesticides and PCBs	4-15
4.4.2.4	Metals	4-15
4.4.3	SEAD-71 Groundwater	4-15
4.4.3.1	Volatile Organic Compounds	4-16
4.4.3.2	Semivolatile Organic Compounds (SVOCs)	4-16

	4.4.3.3 Pesticides and PCBs	4-16
	4.4.3.4 Metals.....	4-17
5.0	CONTAMINANT FATE AND TRANSPORT	5-1
5.1	SEAD-59 CONCEPTUAL SITE MODEL.....	5-1
5.1.1	Summary of SEAD-59 Physical Characteristics	5-1
5.1.2	Summary of SEAD-59 Chemical Impacts	5-2
5.1.3	Conceptual Model Summary	5-3
5.2	SEAD-59 STOCKPILE SOIL CONCEPTUAL SITE MODEL	5-3
5.2.1	Summary of SEAD-59 Stockpile Soil Physical Characteristics	5-3
5.2.2	Summary of SEAD-59 Stockpile Soil Chemical Impacts	5-4
5.2.3	Conceptual Model Summary	5-4
5.3	SEAD-71 CONCEPTUAL SITE MODEL.....	5-4
5.3.1	Summary of SEAD-71 Physical Characteristics	5-5
5.3.2	Summary of SEAD-71 Chemical Impacts	5-6
5.3.3	Conceptual Model Summary	5-6
5.4	SEAD-59 AND SEAD-71 CONTAMINANT FATE AND TRANSPORT	5-7
5.4.1	Overview of Fate and Transport Mechanisms.....	5-7
5.4.1.1	Fate and Transport Mechanisms for Metals.....	5-7
5.4.1.2	Fate and Transport Mechanisms for Organic Compounds.....	5-11
5.4.2	Fate and Transport of Specific Compounds at SEAD-59 and SEAD-71	5-13
5.4.2.1	Metals.....	5-13
5.4.2.2	Volatile Organic Compounds.....	5-21
5.4.2.3	Semivolatile Organic Compounds	5-21
5.4.2.4	Pesticides and PCBs	5-22
6.0	BASELINE HUMAN HEALTH RISK ASSESSMENT	6-1
6.1	SECTION ORGANIZATION.....	6-1
6.2	CONCEPTUAL SITE MODEL.....	6-3
6.2.1	Sources, Release Mechanisms, and Affected Media.....	6-3
6.2.2	Fate and Transport.....	6-3
6.2.3	Physical Setting and Characteristics	6-5
6.2.4	Land Use and Potentially Exposed Populations	6-5
6.2.4.1	Current Land Use.....	6-5
6.2.4.2	Potential Future Land Use	6-6
6.2.4.3	Potentially Exposed Populations	6-6
6.2.5	Identification of Exposure Pathways	6-8
6.3	DATA EVALUATION	6-9
6.3.1	Data Used in Risk Assessment	6-9
6.3.2	Background Data.....	6-10
6.3.3	Data Usability Evaluation	6-10

6.3.4	Soil Sample Depth Identification.....	6-11
6.3.5	Protocol for Using Field Duplicate Results.....	6-11
6.4	IDENTIFICATION OF CHEMICALS OF POTENTIAL CONCERN.....	6-11
6.5	EXPOSURE ASSESSMENT.....	6-13
6.5.1	Derivation of Exposure Point Concentrations.....	6-14
6.5.1.1	Soil EPC.....	6-14
6.5.1.2	Groundwater EPC.....	6-15
6.5.1.3	Ambient Air EPC.....	6-15
6.5.2	Exposure Factors Assumptions.....	6-15
6.5.3	Quantification of Exposure.....	6-17
6.5.3.1	Inhalation of Particulate Matter in Ambient Air.....	6-18
6.5.3.2	Incidental Ingestion of Soil.....	6-21
6.5.3.3	Dermal Contact with Soil.....	6-22
6.5.3.4	Groundwater Intake.....	6-23
6.5.3.5	Dermal Contact with Groundwater.....	6-23
6.5.3.6	Evaluation of Lead Exposure.....	6-25
6.6	TOXICITY ASSESSMENT.....	6-26
6.7	RISK CHARACTERIZATION.....	6-28
6.7.1	Non-Carcinogenic Effects.....	6-28
6.7.2	Carcinogenic Effects.....	6-29
6.7.3	Risk Characterization for Lead Exposure.....	6-30
6.7.4	Risk Summary.....	6-30
6.7.4.1	SEAD-59.....	6-31
6.7.4.2	SEAD-59 Stockpile.....	6-32
6.7.4.3	SEAD-71.....	6-32
6.7.4.4	Lead Risk Characterization Results.....	6-33
6.8	UNCERTAINTY ANALYSIS.....	6-34
6.8.1	Uncertainty in Site Characterization and Data Evaluation.....	6-34
6.8.2	Uncertainty in Exposure Assessment.....	6-36
6.8.3	Uncertainty in Toxicity Assessment.....	6-38
6.8.4	Uncertainty in Risk Characterization.....	6-39
6.8.5	Quantitative Uncertainty Analysis.....	6-39
6.8.5.1	Quantitative Uncertainty Analysis Results Summary.....	6-40
6.8.5.2	Aluminum and Manganese Background Comparison.....	6-41
6.8.5.3	Adolescent Trespasser Exposure Frequency Uncertainty Analysis.....	6-42
6.8.5.4	Quantitative Uncertainty Analysis Conclusion.....	6-43
6.9	COC IDENTIFICATION.....	6-43
6.9.1	SEAD-59 Soil and Groundwater.....	6-43
6.9.2	SEAD-59 Stockpile Soil.....	6-44
6.9.3	SEAD-71 Soil and Groundwater.....	6-44
6.9.3.1	PAHs in SEAD-71 Soil.....	6-44

	6.9.3.2	Iron and Manganese in SEAD-71 Groundwater.....	6-46
6.10		COMPARISON OF CHEMICAL DETECTED IN SITE SAMPLES TO ARARS..	6-48
6.11		SEAD-59 STOCPILE RISK ASSESSMENT FOR RESIDENTIAL RECEPTORS	6-48
6.12		SUMMARY AND CONCLUSIONS	6-49
	6.12.1	SEAD-59 Soil and Groundwater Exposure.....	6-49
	6.12.2	SEAD-59 Stockpile Soil and Groundwater Exposure	6-50
	6.12.3	SEAD-71 Soil and Groundwater Exposure.....	6-50
	6.12.4	Conclusion.....	6-51
7.0		SCREENING LEVEL ECOLOGICAL RISK ASSESSMENT	7-1
7.1		INTRODUCTION	7-1
7.2		STEP 1A: SCREENING-LEVEL PROBLEM FORMULATION.....	7-2
	7.2.1	Environmental Setting.....	7-2
		7.2.1.1 SEAD-59	7-2
		7.2.1.2 SEAD-71	7-3
		7.2.1.3 Habitat and Ecological Community Characterization	7-3
	7.2.2	Preliminary Ecological Conceptual Site Model	7-5
	7.2.3	Identification of Ecological COPCs	7-6
	7.2.4	Selection of Assessment Endpoints	7-8
	7.2.5	Selection of Receptor Species.....	7-8
	7.2.6	Characterization of Exposure Pathways	7-10
7.3		STEP 1B: SCREENING-LEVEL EFFECTS EVALUATION (TOXICITY)	7-11
7.4		STEP 2A: SCREENING-LEVEL EXPOSURE ESTIMATE.....	7-12
7.5		STEP 2B: SCREENING-LEVEL RISK CALCULATIONS	7-15
	7.5.1	Summary of Risk Results and Preliminary COC Identification	7-15
		7.5.1.1 SEAD-59 Soil.....	7-15
		7.5.1.2 SEAD-59 Stockpile Soil.....	7-16
		7.5.1.3 SEAD-71 Soil.....	7-17
	7.5.2	Uncertainties for ERA Steps 1 and 2.....	7-18
		7.5.2.1 Uncertainty in Screening-Level Problem Formulation	7-18
		7.5.2.2 Uncertainty in Screening-Level Ecological Effect Evaluation	7-19
		7.5.2.3 Uncertainty in Screening-Level Exposure Assessment.....	7-20
		7.5.2.4 Uncertainty in Screening-Level Risk Characterization	7-22
7.6		FURTHER REFINEMENT OF CONTAMINANTS OF CONCERN	7-22
	7.6.1	Overall Conservation Evaluation of Ecological Risks in Steps 1 and 2.....	7-23
	7.6.2	Identification of Soil COCs	7-25
		7.6.2.1 SEAD-59 Soil	7-25
		7.6.2.2 SEAD-59 Stockpile Soil	7-29
		7.6.2.3 SEAD-71 Soil	7-32
7.7		RISK MANAGEMENT	7-36
	7.7.1	Impact to Habitat Based on Future Site Use.....	7-36

7.7.2 Comparison of Site Data with Background.....7-36

7.8 SUMMARY7-37

8.0 CONCLUSIONS AND RECOMMENDATIONS.....8-1

8.1 CONCLUSIONS8-1

8.1.1 SEAD-598-1

8.1.2 SEAD-59 Stockpile.....8-1

8.1.3 SEAD-718-2

8.2 RECOMMENDATIONS8-3

LIST OF TABLES

<u>Number</u>	<u>Title</u>
1-1	SEAD-59 ESI Monitoring Well Level Summary
1-2	SEAD-71 ESI Monitoring Well Level Summary
1-3	Climatological Data for Seneca Army Depot Activity
3-1	Summary of 2002 TCRA Nonusable Analytical Results
3-2A	SEAD-59 Determination of Use of Historical Sample
3-2B	SEAD-71 Determination of Use of Historical Sample
3-3A	SEAD-59 – Soil Samples Representative of Current Site Conditions
3-3B	SEAD-71 – Soil Samples Representative of Current Site Conditions
3-3C	SEAD-59 Stockpile – Soil Samples Representative of Current Site Conditions
3-4	Summary of Well Development Criteria
3-5	Groundwater Elevation Data – 2004 Sampling Events
4-1A	SEAD-59 Surface Soil (0-2 ft) Summary Statistics
4-1B	SEAD-59 Subsurface Soil (2-15 ft) Summary Statistics
4-2A	SEAD-59 Groundwater April 2004 Summary Statistics
4-2B	SEAD-59 Groundwater August 2004 Summary Statistics
4-3	SEAD-59 Stockpile Summary Statistics
4-4	SEAD-59 Stockpile – BTE Concentrations Greater than 10 mg/kg
4-5A	SEAD-71 Surface Soil (0-2 ft) Summary Statistics
4-5B	SEAD-71 Subsurface Soil (2-15 ft) Summary Statistics
4-6A	SEAD-71 Groundwater April 2004 Summary Statistics
4-6B	SEAD-71 Groundwater August 2004 Summary Statistics
5-1	Relative Relationship Between Koc and Mobility
6-1	Selection of Exposure Pathways
6-2A	SEAD-59 Site Soil– Occurrence, Distribution, and Selection of Chemicals of Potential Concern
6-2B	SEAD-71 Soil – Occurrence, Distribution, and Selection of Chemicals of Potential Concern
6-2C	SEAD-59 Stockpile Soil – Occurrence, Distribution, and Selection of Chemicals of Potential Concern
6-3A	SEAD-59 Site Groundwater – Occurrence, Distribution, and Selection of Chemicals of Potential Concern
6-3B	SEAD-71 Groundwater – Occurrence, Distribution, and Selection of Chemicals of Potential Concern

6-4A	SEAD-59 Surface Soil – Soil Exposure Point Concentration Summary
6-4B	SEAD-71 Surface Soil – Soil Exposure Point Concentration Summary
6-4C	SEAD-59 Stockpile Soil – Soil Exposure Point Concentration Summary
6-5A	SEAD-59 Surface and Subsurface Soil – Soil Exposure Point Concentration Summary
6-5B	SEAD-71 Surface and Subsurface Soil – Soil Exposure Point Concentration Summary
6-6A	SEAD-59 – Groundwater Exposure Point Concentration Summary
6-6B	SEAD-71 – Groundwater Exposure Point Concentration Summary
6-7A	SEAD-59 Surface Soil – Ambient Air Exposure Point Concentrations
6-7B	SEAD-71 Surface Soil – Ambient Air Exposure Point Concentrations
6-7C	SEAD-59 Stockpile Soil – Ambient Air Exposure Point Concentrations
6-8A	SEAD-59 Surface and Subsurface Soil – Ambient Air Exposure Point Concentrations
6-8B	SEAD-71 Surface and Subsurface Soil – Ambient Air Exposure Point Concentrations
6-9A	Exposure Factors Assumptions for Construction Worker
6-9B	Exposure Factors Assumptions for Industrial Worker
6-9C	Exposure Factors Assumptions for Child Trespasser/Child Visitor
6-10	Suspended Particulate Concentrations Measured at SEDA
6-11A	Non-Cancer Toxicity Data – Oral/Dermal
6-11B	Non-Cancer Toxicity Data – Inhalation
6-11C	Cancer Toxicity Data – Oral/Dermal
6-11D	Cancer Toxicity Data – Inhalation
6-12A	SEAD-59 – Calculation of Total Non-Carcinogenic and Carcinogenic Risks
6-12B	SEAD-71 – Calculation of Total Non-Carcinogenic and Carcinogenic Risks
6-12C	SEAD-59 Stockpile Soil – Calculation of Total Non-Carcinogenic and Carcinogenic Risks
6-12D	SEAD-71 (Fenced Area Excluded) – Calculation of Total Non-Carcinogenic and Carcinogenic Risks
6-13A	Total Non-carcinogenic and Carcinogenic Risks for Uncertainty Analysis – SEAD-59
6-13B	Total Non-carcinogenic and Carcinogenic Risks for Uncertainty Analysis – SEAD-59 Stockpiles
6-13C	Total Non-carcinogenic and Carcinogenic Risks for Uncertainty Analysis – SEAD-71 (Fenced Area Excluded)
6-14	Comparison of Site Aluminum and Manganese Concentrations with Background
6-15	Total Non-carcinogenic and Carcinogenic Risks for Adolescent Trespasser – Uncertainty Analysis
6-16	Total Non-carcinogenic and Carcinogenic Risks Associated with SEAD-59 Stockpiles for Future Residential Use Scenario
7-1	Policy Goals, Ecological Assessment and Measurement Endpoints, and Decision Rules
7-2A	Index of Subsurface Soil Samples (2-4 ft.) – SEAD-59
7-2B	Index of Subsurface Soil Samples (2-4 ft.) – SEAD-71

LIST OF FIGURES

<u>Number</u>	<u>Title</u>
1-1	Location Map
1-2	Seneca Army Depot Map
1-3	SEAD-59 Site Plan
1-4	SEAD-71 Site Plan
1-5	Regional Geologic Cross Sections
1-6	Bedrock Stratigraphic Column
1-7	Physiographic Map of Seneca County
1-8	General Soil Map Seneca County, New York
1-9	SEAD-59 ESI Groundwater Elevation Map
1-9A	SEAD-59/71 Groundwater Elevation Map
1-10	SEAD-71 ESI Groundwater Elevation Map
1-11	Future Land Use
1-12	Wind Roses
1-13	Average Monthly Precipitation in Proximity of Seneca Army Depot Activity
1-14	Distribution of Known Private Wells Near SEDA
2-1	SEAD-59 Fill Area West of Building 135 BTEX in Soils
2-2	SEAD-59 ESI and Phase I RI Sample Locations
2-3	SEAD-59 Phase I RI Total Benzo(a)pyrene Concentrations in Soil
2-4	SEAD-59 Phase I RI Total Xylene Concentrations in Soil
2-5	SEAD-71 Phase I RI Sampling Locations and GPR Results
2-6	SEAD-71 Phase I RI Total Benzo(a)pyrene Concentrations in Soil
2-7	SEAD-59 2002 TCRA Excavated Areas
2-8	SEAD-71 2002 TCRA Excavated Areas
2-9	SEAD-59 2002 TCRA Confirmatory Sample Locations
2-10	SEAD-71 2002 TCRA Confirmatory Sample Locations
3-1	SEAD-59 Confirmatory and Historical Sample Locations
3-2	SEAD-71 Confirmatory and Historical Sample Locations
4-1	SEAD-71 BTE Concentrations
4-2	SEAD-71 Fenced Area Lead Concentrations
6-1	Conceptual Site Model for SEAD-59 and SEAD-71
7-1	Screening Level Ecological Risk Assessment Process
7-2	Conceptual Site Model for SEAD-59 and SEAD-71

LIST OF APPENDICES

- Appendix A Analytical Data
- Sample Duplicate Merging Results
 - SEAD-59 Soil Sample Results
 - SEAD-59 Groundwater Sample Results
 - SEAD-59 Stockpile Soil Sample Results
 - SEAD-71 Soil Sample Results
 - SEAD-71 Groundwater Sample Results
 - Benzo(a)pyrene Toxicity Equivalency Calculations
 - SEAD-59/71 Soil TCLP Data
 - SEAD-59/71 Soil TPH Data
 - SEAD-59 ESI Groundwater TPH Data
- Appendix B Background Data
- Soil
 - Groundwater
- Appendix C SEAD-59 Human Health Risk Assessment Calculation Tables
- Appendix D SEAD-59 Stockpile Human Health Risk Assessment Calculation Tables
- Appendix E SEAD-71 Human Health Risk Assessment Calculation Tables
- Appendix F SEAD-71 (Fenced Area Excluded) Human Health Risk Assessment Calculation Tables
- Appendix G Human Health Risk Assessment Uncertainty Analysis Risk Calculation Tables
- Appendix H Human Health Risk Assessment Uncertainty Analysis Background Comparison Analysis
- Appendix I Human Health Risk Calculation Tables for SEAD-59 Stockpile Soil Exposure Under Residential Scenario
- Appendix J Ecological Risk Assessment Calculation Tables
- SEAD-59
 - SEAD-59 Stockpile
 - SEAD-71
 - SEAD-71 (Fenced Area Excluded)
- Appendix K Copy of Table 1 from ENSR 2002 Removal Report
- Appendix L Response to Comments

ACRONYMS AND ABBREVIATIONS

ALM	Adult Lead Model
AQCR	Air Quality Control Region
ARAR	Applicable or Relevant and Appropriate Requirements
ASP	Analytical Services Protocol
AST	Above Ground Storage Tank
AT	Averaging Time
BAF	Bioaccumulation Factor
BaP	Benzo(a)pyrene
bgs	Below Grade Surface or Below Ground Surface
BOD-5	Five-Day Biologic Oxygen Demand
BRAC	Base Realignment and Closure
BTAG	Biological Technical Assistance Group
BTE	Benzo(a)pyrene Toxicity Equivalent
CAS	Columbia Analytical Services
CEC	Cation Exchange Capacity
CERCLA	Comprehensive Environmental Responsibility, Compensation, and Liability Act
CLP	Contract Laboratory Program
COC	Chemical or Contaminants of Concern
COPC	Chemicals of Potential Concern
cPAH	Carcinogenic Polynuclear Aromatic Hydrocarbon
CRDL	Contract Required Detection Limit
CSM	Conceptual Site Model
CT	Central Tendency
cy	Cubic Yards
DFW	Division of Fish and Wildlife
DO	Dissolved Oxygen
DOA	Department of the Army
DoD	Department of Defense
DQO	Data Quality Objective
e.g.,	for example
EPC	Exposure Point Concentration
ERA	Ecological Risk Assessment
ERAGS	Ecological Risk Assessment Guidance for Superfund
ESI	Expanded Site Inspection
FFA	Federal Facilities Agreement
ft.	Feet
GI	Gastrointestinal
GPR	Ground Penetrating Radar
gpm	Gallon Per Minute or Gallons Per Minute
GSDi	Individual Geometric Standard Deviation
H	Henry's Law Constant
HERD	Human and Ecological Risk Division

HHRA	Human Health Risk Assessment
HI	Hazard Index
HQ	Hazard Quotient
hr	Hour or Hours
i.e.,	that is
ICP	Inductively Coupled Plasma
IRIS	Integrated Risk Information System
IEUBK	Integrated Exposure Uptake Biokinetic Model for Lead in Children
K_d	Distribution Coefficient
K_{oc}	Organic Carbon Partition Coefficient
L/day	Liter or Liters Per Day
LC50	Median Lethal Concentration
LD50	Median Lethal Dose
LOEAL	Lowest-Observed-Adverse-Effect-Level
LCS	Laboratory Control Sample
LCSD	Laboratory Control Sample Duplicate
LRA	Local Development Authority
MCL	Maximum Contaminant Level
MITKEM	Mitkem Corporation
MS	Matrix Spike Sample Designation
MSD	Matrix Spike Duplicate Sample Designation
MSL	Mean Sea Level
mg/kg	Milligram or Milligrams per Kilogram
mg.kg-day	Milligram or Milligrams per Kilogram-day
mg/L	Milligram or Milligrams per Liter
ml/g	Milliliter or Milliliters per Gram
NCEA	National Center for Environmental Assessment
NGVD	National Geodetic Vertical Datum
NHANES	National Health and Nutrition Evaluation Evaluation Survey
NOAEL	No-Observed-Adverse-Effect-Level
NPL	National Priority List
NTU	Nephelometric Turbidity Units
NY	New York
NYSDEC	New York State Department of Environmental Conservation
NYSDOH	New York State Department of Health
OB	Open Burn
ORNL	Oak Ridge National Laboratory
ORP	Oxidation-Reduction Potential
OSWER	Office of Solid Waste and Emergency Response
PAH	Polynuclear Aromatic Hydrocarbon
PbB	Estimate Blood Lead
PCB	Polychlorinated Biphenyl
PID	Planned Industrial Development
PM ₁₀	Particulate Matter less than 10 μ m Aerodynamic Diameter

ppm	Part or Parts Per Million
PPRTV	Provisional Peer Reviewed Toxicity Values
PRG	Preliminary Remediation Goals
QA/QC	Quality Assurance/Quality Control
QAPP	Quality Assurance Project Plan
QC	Quality Control
%R	Percent Recovery
RAGS	Risk Assessment Guidance for Superfund
RCRA	Resource Conservation and Recovery Act
RfC	Reference Concentration
RfD	Reference Dose
RI	Remedial Investigation
RI/FS	Remedial Investigation/Feasibility Study
RL	Reporting Limit
RME	Reasonable Maximum Exposure
ROD	Record of Decision
RPD	Relative Percent Difference
RQD	Rock Quality Designation
SEC	Secondary Drinking Water Guidance Value
SEDA	Seneca Army Depot Activity
SEV	Screening Ecotoxicity Value
SLERA	Screening-Level Ecological Risk Assessment
SMDP	Scientific Management Decision Point
SOP	Standard Operating Procedure
SOW	Statement Of Work
STSC	Superfund Health Risk Technical Support Center
SVOC	Semivolatile Organic Compound
SW	Surface Water Sample Designation
SWMU	Solid Waste Management Unit
TAGM	Technical and Administrative Guidance Memorandum
TAL	Target Analyte List
TBC	To Be Considered
TCL	Target Compound List
TCRA	Time-Critical Removal Action
TDS	Total Dissolved Solids
TEF	Toxicity Equivalency Factors
TOGS	Technical Operating Guidance Series
TPH	Total Petroleum Hydrocarbons
TSP	Trisodium Phosphate
TSS	Total Suspended Solids
UCL	Upper Confidence Limits
USAEHA	United States Army Environmental Hygiene Agency
USACE	United States Army Corps of Engineers
USCS	Unified Soil Classification System
USDA	United States Department of Agriculture
USEPA	United States Environmental Protection Agency

USGS	United States Geological Survey
VOC	Volatile Organic Compound
yr	Year
$\mu\text{g}/\text{kg}$	Microgram or Micrograms per Kilogram
$\mu\text{g}/\text{L}$	Microgram or Micrograms per Liter

REFERENCES

- Alexander, Martin. 2000. Aging, bioavailability, and overestimation of risk from environmental pollutants. *Environmental Science and Technology* 34(20):4259-4265.
- Agency for Toxic Substances and Disease Registry. 2003. Toxicological Profile for Zinc.
- Agency for Toxic Substances and Disease Registry. 1999. Toxicological Profile for Cadmium.
- Agency for Toxic Substances and Disease Registry. 1992. Toxicological Profile for Antimony.
- Army, United States Environmental Protection Agency (USEPA) Region 2, New York State Department of Environmental Conservation (NYSDEC). 1993. Federal Facilities Agreement (FFA).
- Bartlett, R.J. and B. James. 1979. Behavior of chromium in soils: III. oxidation. *J. Environ. Qual.* 8:31-35.
- Bartlett, R.J. and J.M. Kimble. 1976. Behavior of Chromium in Soils: II. hexavalent forms. *J. Environ. Qual.* 5:383-386.
- Biomedical and Environmental Information Analysis (BELA). 1989. The Installation Restoration Program Toxicology Guide. Volume 4. BELA Health and Safety Research Division, Oak Ridge National Laboratory. July.
- Bloomfield, C. and G. Pruden. 1980. The behavior of Cr(VI) in soil under aerobic and anaerobic conditions. *Environ. Pollut. Ser. A.* 103-114.
- Brett, C.E., Dick, V.B, Baird, G.C., 1991, Comparative Taphonomy and Paleoecology of Middle Devonian Dark Gray and Black Shale Facies from Western New York. in eds., Landing, E.L. and Brett, C.E., *Dynamic Stratigraphy and Depositional Environments of the Hamilton Group (Middle Devonian) in New York State, Part II*, New York State Museum Bulletin Number 469. pp. 5-36.
- Canadian Council of Ministers of the Environment. 2003. Canadian Environmental Quality Guideline. December.
- Code of Federal Register. Title 40, Chapter 1, Part 143. National Secondary Drinking Water Regulations.
- Cornell University, 1967. Land Use Report.
- Crain, L.J. 1974. Groundwater Resources of the Western Oswego River Basin, New York. U.S. Geological Survey and State of New York Basin Planning Report ORB-5.

- Dragun, James. 1988. The Soil Chemistry of Hazardous Materials. The Hazardous Materials Control Research Institute.
- Efroymson, R.A. et al. 1997a. Toxicological Benchmarks for Contaminants of Potential Concern for Effects on Soil and Litter Invertebrates and heterotrophic Process: 1997 Revision. November.
- Efroymson, R.A. et al. 1997b. Toxicological Benchmarks for Screening Contaminants of Potential Concern for Effects on Terrestrial Plants: 1997 Revision. November.
- ENSR. 2002a. Final Draft Removal Report, SEAD-59 and 71 Time Critical Removal Action. December.
- ENSR. 2002b. Final Work Plan, SEAD-59 and 71 Time Critical Removal Action. August.
- Gas Research Institute. 1988. Management of Manufactured Gas Plant Sites, Volume III, Risk Assessment. GRI-87/0260.3. May.
- Gray, L.M., 1991, Paleocology, Origin, and Significance of a Shell-Rich Bed in the Lowermost Part of the Ludlowville Formation (Middle Peronian, Central New York). in eds. Landing, E.L. and Brett, C.E., Dynamic Stratigraphy and Depositional Environments of the Hamilton Group (Middle Devonian) in New York State, Part II, New York State Museum Bulletin 469, p.93-105.
- Griffin, R.A. and N.F. Shimp. 1978. Attenuation of pollutants in municipal landfill leachate by clay minerals. EPA-600/2-78-157.
- Hazardous Substance Data Bank (HSDB), Toxnet, National Library of Medicine: Specialized Information Services. 2005 On-line resources available at <http://toxnet.nlm.nih.gov>.
- Holzworth, George C. 1972. Mixing Heights, Windspeed, and Potential for Urban Air Pollution throughout the Contiguous United States. January.
- Kinniburgh, D.G. and M.L. Jackson. 1978. Adsorption of mercury (II) by iron hydroxide gel. Soil Sci. Soc. Am. J. 42:45-47.
- LaSala, A.M. Jr. 1968. Groundwater Resources of the Erie-Niagara Basin, New York: Basic Planning Report ENB-3, State of New York Conservation Department with Resources Commission.
- Lindsay, W. L. 1979. Chemical equilibria in soils. John Wiley and Sons. New York.
- Loehr, R.C. 1996. The Environmental Impact of Soil Contamination: Bioavailability, Risk Assessment, and Policy Implications. Reason Foundation (Los Angeles, CA) and National Environmental Policy Institute (Washington, D.C.). Policy Study No. 211.

- Magee, B., P. Anderson, and D. Burmaster. 1996. Absorption adjustment factor (AAF) distributions for polycyclic aromatic hydrocarbons (PAHs). *Human Ecol. Risk Assessment* 2(4):841-873.
- McGovern, C.E. undated. Background Concentrations of 20 Elements in Soils with Special Regard for New York State. Wildlife Pathology Unit, Wildlife Resource Center, NYSDEC.
- McLean, J.E., Bledsoe, B.E. 1992. Behavior of Metals in Soils. In: EPA Ground Water Issue EPA/540/S-92/018 pp. 1-20.
- Merin, Ira. S. 1992. Conceptual Model of Ground Water Flow in Fractured Siltstone Based on Analysis of Rock Cores, Borehole Geophysics, and Thin Sections. Ground Water Monitoring Review, Fall, 1992.
- Metcalf & Eddy. 1989. Criteria Development Report for the Closure of Nine Burning Pads Seneca Army Depot, Seneca, New York; Vol. I.
- Mozola, A.J. 1951. The Groundwater Resources of Seneca County, New York, Bulletin GW-26. Water, Power and Control Commission, Department of Conservation, State of New York, Albany, New York.
- Nagy, et al. 1999. Energetics of Free-ranging Mammals, Reptiles, and Birds. *Ann. Rev. Nutr.* 19: 247-277.
- Nakles, D.V., Harju, J.A. 2002. Environmentally Acceptable Endpoints in Soil: Basic Concepts and Assessment Approaches.
- Netherlands Ministry of Housing, Spatial Planning and Environment. 2000 Circular on Target Values and Intervention Values for Soil Remediation.
- NYSDEC. 1998 with 2000 and 2004 Addendum. Ambient Water Quality Standard and Guidance Values and Groundwater Effluent Limitations.
- New York State Department of Environmental Conservation (NYSDEC). 1994. Technical and Administrative Guidance Memorandum (TAGM): Fish and Wildlife Impact Analysis for Inactive Hazardous Waste Sites, October 1994.
- Oscarson, D.W., P.M. Huang, U.T. Hammer, and W.K. Liaw. 1983. Oxidation and sorption of arsenite by manganese dioxide as influenced by surface coatings of iron and aluminium oxides and calcium carbonate. *Water Air Soil Pollut.* 20:233-244.
- Parsons. 2004. Signed Final Record of Decision (ROD) for Sites Requiring Institutional Controls in the Planned Industrial/Office Development or Warehousing Areas. October.

- Parsons. 2002a. Revised Final Phase I Remedial Investigation (RI) at the Fill Area West of Building 135 (SEAD-59), and the Alleged Paint Disposal Area (SEAD-71). July
- Parsons. 2002b. Revised Final Action Memorandum for Time-Critical Removal Actions at SEAD-59 and SEAD-71. June
- Parsons. 2002c. Revised Final Decision Document for Time-Critical Removal Actions at SEAD-59 and SEAD-71. June
- Parsons. 2001. Action Memorandum and Decision Document Removal Actions, Three VOC Sites (SEADs 38, 39, & 40).
- Parsons. 1996. Draft Final Expanded Site Inspection - Seven Low Priority AOCs SEADs 60, 62, 63, 64 (A,B,C, and D), 67, 70, and 71. April
- Parsons. 1995. Expanded Site Inspection - Eight Moderately Low Priority AOCs SEADs 5, 9, 12 (A and B), 43, 56, 69, 44 (A and B), 50, 58, and 59. December
- Rogers, R. D. 1976. Methylation of mercury in agricultural soils. *J. Environ. Qual.* 5:454-458.
- Rogers, R. D. 1977. Abiological methylation of mercury in soil. *J. Environ. Qual.* 6:463-467
- Ruby, M.V., R. Schoof, W. Brattin, M. Goldade, G. Post, M. Harnois, D.E. Mosby, S.W. Casteel, W. Berti, M. Carpenter, D. Edwards, D. Cragin, and W. Chappell. 1999. Advances in evaluating the oral bioavailability of inorganics in soil for use in human health risk assessment. *Environmental Science & Technology* 33(21): 3697-3705.
- Sample et al. 1996. Toxicological Benchmarks for Wildlife: 1996 Revision.
- Shacklette, H.T. and Boerngen, J.G. 1984. Element Concentrations in Soils at other Surficial Materials of the Contiguous United States. U.S.G.S. Prof Paper 1270, Washington
- Shuman, L.M. 1991. Chemical Forms of Micronutrients in Soils. In: Mortvedt et al., J.J. (eds) Micronutrients in Agriculture, ASA, CSSA, and SSSA. Madison, WI 1991. pp113-144.
- United States Army Corps of Engineers (USACE). 2001. Shell for Analytical Chemistry Requirements. In EM200-1-3.
- United States Environmental Protection Agency (USEPA). 2005a. Integrated Risk Information System. On-line database. <http://www.epa.gov/iris/>
- United States Environmental Protection Agency (USEPA). 2005b. The Ecological Soil Screening Level (Eco-SSL). Interim. Revised in March 2005.

- United States Environmental Protection Agency (USEPA). 2004a. Risk Assessment Guidance for Superfund, Volume I: Human health Evaluation Manual (Part E, Supplemental Guidance for Dermal Risk Assessment) Interim Review Draft. Office of Emergency and Remedial Response. August.
- United States Environmental Protection Agency (USEPA). 2004b. Contract Laboratory Program National Functional Guidelines for Inorganic Data Review. July.
- United States Environmental Protection Agency (USEPA). 2004c. ProUCL Version 3.0 User Guide. April.
- United States Environmental Protection Agency (USEPA). 2003a. Human Health Toxicity Values in Superfund Risk Assessment, Memorandum to Superfund National Policy Managers, Region 1-10. Office of Solid Waste and Emergency Response. December.
- USEPA. 2003b. Assessing Intermittent or Variable Exposures at Lead Sites. November. EPA-540-R-03-008.
- United States Environmental Protection Agency (USEPA). 2003c. The Ecological Soil Screening Level (Eco-SSL). Interim. Revised in 2003.
- United States Environmental Protection Agency (USEPA). 2003d. Recommendations of the Technical Review Workgroup for Lead for an Interim Approach to Assessing Risks Associated with Adult Exposures to Lead in Soil. January.
- United States Environmental Protection Agency (USEPA). 2002a. Supplemental Guidance For Developing Soil Screening Levels For Superfund Sites. December.
- United States Environmental Protection Agency (USEPA). 2002b. Calculating Upper Confidence Limits For Exposure Point Concentrations At Hazardous Waste Sites. OSWER 9285.6-10. December. Office of Solid Waste and Emergency Response. October 1988.
- United States Environmental Protection Agency (USEPA). 2002c. Guidance for Comparing Background and Chemical Concentrations in Soil for CERCLA Sites. Office of Emergency and Remedial Response. September.
- United States Environmental Protection Agency (USEPA). 2002d. List of Drinking Water Contaminants & MCLs. EPA816-F-02-013. July.
- United States Environmental Protection Agency (USEPA). 2002e. Blood Lead Concentrations of U.S. Adult Females: Summary Statistics from Phases 1 and 2 of the National Health and Nutrition Evaluation Survey (NHANES III). March. Office of Solid Waste and Emergency Response. OSWER #9285.7-52

- United States Environmental Protection Agency (USEPA). 2001. Eco Update. The Role of Screening-Level Risk Assessments and Refining Contaminants of Concern in Baseline Ecological Risk Assessments. Office of Solid Waste and Emergency Response. June.
- United States Environmental Protection Agency (USEPA). 2000a. Bioaccumulation Testing and Interpretation for the Purpose of Sediment Quality Assessment, Status and Needs. Office of Water and Office of Solid Waste. February.
- United States Environmental Protection Agency (USEPA). 2000b. The Ecological Soil Screening Level (Eco-SSL). Interim.
- United States Environmental Protection Agency (USEPA). 1999a. USEPA Contract Laboratory Program National Functional Guidelines for Organic Data Review. October.
- United States Environmental Protection Agency (USEPA). 1999b. Screening Level Ecological Risk Assessment Protocol for Hazardous Waste Combustion Facilities. Peer Review Draft. November.
- United States Environmental Protection Agency (USEPA). 1998a. Clarification to the 1994 Revised Interim Soil Lead Guidance for CERCLA Sites and RCRA Corrective Action Facilities. August.
- United States Environmental Protection Agency (USEPA). 1998b. Guidelines for Ecological Risk Assessment. Final. April.
- United States Environmental Protection Agency (USEPA). 1997a. Exposure Factors Handbook. Office of Research and Development. August.
- United States Environmental Protection Agency (USEPA). 1997b. Health Effects Assessment Summary Tables. Office of Solid Waste and Emergency Response. July
- United States Environmental Protection Agency (USEPA). 1997c. Ecological Risk Assessment Guidance for Superfund: Process for Designing and Conducting Ecological Risk Assessment. Interim Final. Office of Solid Waste and Emergency Response. June.
- United States Environmental Protection Agency (USEPA). 1996a. Recommendations of the Technical Review Workgroup for Lead for an Interim Approach to Assessing Risks Associated with Adult Exposures to Lead in Soil. December.
- United States Environmental Protection Agency (USEPA). 1996b. Soil Screening Guidance: Technical Background Document. Office of Solid Waste and Emergency Response. May.
- United States Environmental Protection Agency (USEPA). 1994. Guidance Manual for the Integrated Exposure Uptake Biokinetic Model for Lead in Children. February.

- United States Environmental Protection Agency (USEPA). 1993a. Environmental Protection Agency (EPA), Office of Research and Development, Washington, DC. Provisional Guidance for Quantitative Risk Assessment of Polycyclic Aromatic Hydrocarbons. EPA/600/R-93/089.
- United States Environmental Protection Agency (USEPA). 1993b. Wildlife Exposure Factors Handbook.
- United States Environmental Protection Agency (USEPA). 1991. Human Health Evaluation Manual, Supplemental Guidance: Standard Default Exposure Factors.
- United States Environmental Protection Agency (USEPA). 1989. Risk Assessment Guidance for Superfund. Volume 1 – Human Health Evaluation Manual Supplement (Part A). Office of Emergency and Remedial Response. December.
- United States Environmental Protection Agency (USEPA) Region 2. Region 2 RCRA and CERCLA Data Validation Standard Operating Procedures (SOPs). On-line resources at <http://www.epa.gov/region02/desa/hsw/sops.htm>.
- United States Environmental Protection Agency (USEPA) Region 2. 1998. Ground Water Sampling Procedure Low Stress (Low Flow) Purging And Sampling. March 16.
- United States Environmental Protection Agency (USEPA) Region III. 2004. Risk-Based Concentration (RBC) Table. On-line database last updated October. <http://www.epa.gov/reg3hwmd/risk/index.htm>
- United States Environmental Protection Agency (USEPA) Region III. 1995. Region III BTAG Screening Levels.
- United States Environmental Protection Agency (USEPA) Region 5. 2003. Ecological Screening Levels.
- United States Environmental Protection Agency (USEPA) Region 9. 2004. Preliminary Remediation Goals. On-line resources available at <http://www.epa.gov/region09/waste/sfund/prg/index.htm>, last updated December.
- Valberg PA, Beck BD, Bowers TS, Keating JL, Bergstrom PD, Boardman PD. 1997. Issues in setting health-based cleanup levels for arsenic in soil. *Regul Toxicol Pharmacol* 26:219–229.
- Water Information Center. 1973 Water Atlas of the United States.
- Wester, R.C., H.I. Maibach, D.A. Bucks, L. Sedik, J. Melendres, C. Liao, and S. DiZio. 1990. Percutaneous absorption of [14C]DDT and [14C]Benzo(a)pyrene from soil. *Fundamental and Applied Toxicology* 15:510-516.

Whitefish Point Bird Observatory. 2005. On-line resources available at <http://www.wpbo.org/featured/robin/>

Wright, M. 2001. Dietary Reference Intakes. On-line resources available at <http://www.fcs.uga.edu/pubs/PDF/FDNS-E-65.pdf>.

EXECUTIVE SUMMARY

This section summarizes the Phase II Remedial Investigation (RI) Report for the Fill Area West of Building 135 (SEAD-59) and the Alleged Paint Disposal Area (SEAD-71) at the Seneca Army Depot Activity (SEDA) in Romulus, New York. **Sections 1** through **7** of the report present an evaluation of the current site conditions. Historical investigations at these two sites include an Expanded Site Investigation (ESI) conducted in 1994 (Parsons, 1995, 1996) and a Phase I RI conducted in 1997 (Parsons, 2002a). Data from these investigations indicated that potential risks existed at these sites due to the presence of site debris (e.g. drums and paint cans) and elevated levels of PAHs and metals in soil. Due to the potential risks from the sites and the potential for exposure of workers and other users increasingly present at the Depot, the Army consulted with USEPA and NYSDEC and decided to conduct a time-critical removal action (TCRA) at the sites as documented in the Decision Document for Time-Critical Removal Actions at SEAD-59 and SEAD-71 (Parsons, 2002c). The TCRA was conducted at both sites by ENSR in 2002 (ENSR, 2002a) and approximately 15,000 cubic yards of soil and 50 tons of debris were excavated from the two sites.

Section 1 through **Section 3** of the report presents an introduction of the sites and a summary of the historical investigations conducted at the sites. Detailed descriptions of the chemical impacts at the sites, the environmental fate and transport evaluation, the baseline human health risk assessment, and the screening level ecological risk assessment are presented in **Sections 4, 5, 6, and 7** of this report, respectively. This section summarizes the information regarding sources and types of contaminants present at the sites, contaminant release and transport mechanisms, affected media, and potential human health and ecological risks at SEAD-59 and SEAD-71.

E.1 NATURE AND EXTENT OF IMPACT

E.1.1 Nature and Extent of Impact at SEAD-59

The nature and extent of contamination at SEAD-59 were evaluated through the 1994 ESI, the 1997 Phase I RI, and the 2002 TCRA. The media investigated at SEAD-59 included soil (collected from soil borings, test pits, perimeter and floor of excavated areas, and stockpiles of excavated soil) and groundwater. The primary constituents of potential concern at SEAD-59 are polycyclic aromatic hydrocarbons (PAHs) and metals in soil.

Soil

The 2002 TCRA substantially reduced the contaminant levels in SEAD-59 soil. A summary of the remaining impact at the site is listed below:

- Acetone was detected twice at concentrations exceeding the TAGM, 19 other VOC analytes were detected in soil below TAGM.
- All metals except aluminum, selenium, and vanadium were detected at concentrations above the corresponding TAGM values.
- Seven carcinogenic PAHs (cPAHs) and 4-chloroaniline were detected above the TAGM values, and another 24 SVOC analytes were detected in soil samples with concentrations below the TAGM values. cPAHs were detected predominantly in soil from the area north of the access road to Building 311; cPAHs were detected in 12 soil samples out of 84 samples from south of access road. The site-wide average Benzo(a)pyrene Toxicity Equivalent (BTE) concentration in surface (0-2 feet below ground surface (bgs)) and subsurface soils (2-15 feet bgs) were 1.36 mg/kg and 1.44 mg/kg, respectively. The average BTE concentrations in surface and subsurface soil were below the limit of 10 mg/kg, which was recommended as a cleanup goal for cPAHs at SEAD-11 by NYSDEC in January 2004.
- 17 pesticides and Arochlor-1260 were detected in soil samples; however, the concentrations were all below the TAGM values except that 4,4'-DDT and 4,4'-DDE concentrations in one sample were above the TAGM values.

Groundwater

Based on the April and August 2004 sampling data, five metals (aluminum, antimony, iron, manganese, and sodium) were detected at concentrations above their respective NYSDEC Ambient Water Quality Standard for Class GA groundwater or the values specified in the USEPA Secondary Drinking Water Regulations. Two VOCs, one SVOC, and two pesticides were detected in SEAD-59 groundwater but the concentrations were below the NYSDEC Class GA Standards. No PCBs were detected in groundwater at SEAD-59.

E.1.2 Nature and Extent of Impact of SEAD-59 Stockpile

The SEAD-59 Stockpiles are soil excavated from SEAD-59 during the 2002 TCRA and remained at the site after the TCRA. The primary contaminants in the Stockpile soil are similar to SEAD-59: PAHs and metals. A summary of the impacts from the stockpile soil is listed below:

- Ten VOC analytes were detected but the concentrations were all below the TAGM values.
- Seven cPAHs were detected at concentrations above the TAGM values, and 15 other SVOCs were detected at concentrations below the TAGM values. The average BTE concentration in stockpile soil was 8.1 mg/kg, below the 10 mg/kg cleanup goal recommended for cPAHs at SEAD-11 by NYSDEC in January 2004.
- Eight pesticides were detected at concentrations below the TAGM values and no PCBs were detected.

- 23 metals were detected in stockpile soil and antimony, chromium, copper, lead, magnesium, manganese, mercury, nickel, silver, sodium, thallium, and zinc were detected at concentrations above the TAGM values.

E.1.3 Nature and Extent of Impact at SEAD-71

The media investigated at SEAD-71 included soil (collected from surface soils, soil borings, test pits, perimeter of excavated areas, and windrow piles) and groundwater. The primary contaminants at SEAD-71 are PAHs and metals in soil.

Soil

A summary of the remaining impact in soil at SEAD-71 is presented below:

- 13 VOC analytes were detected but the concentrations were below the TAGM values.
- 15 SVOC analytes (14 PAHs) were detected at concentrations above the TAGM values and nine SVOC analytes were detected at concentrations below the TAGM. cPAHs had the largest number of exceedances, and the remaining PAHs had seven or less exceedances out of 77 soil samples. The site-wide average BTE concentrations in surface (0-2 ft bgs) and subsurface soils (2-15 ft bgs) were 11.6 mg/kg and 5.4 mg/kg, respectively. Elevated PAH concentrations were detected within the Fenced Area and the PAH concentrations in 14 out of 15 samples exceeded the TAGM values. The elevated PAH concentrations in the Fenced Area were limited to surface soil samples (0-0.2 ft bgs) and might be from asphalt materials in the hard fill and oil used in the construction of the area. The PAH concentrations from samples taken at greater than 1 foot bgs. were a magnitude lower than the concentrations in surface soil. The surface soil BTE average concentration in SEAD-71 outside the Fenced Area was 1.6 mg/kg.
- Endrin and heptachlor epoxide were detected at concentrations above the TAGM values. 17 other pesticides and one PCB (Aroclor-1260) were detected but the concentrations were below the TAGM values.
- 23 metals were detected in SEAD-71 soil. The concentrations of 17 metals exceeded the corresponding TAGM values in at least one soil samples. The maximum lead concentration (3,470 mg/kg) was detected in a surface soil sample from the Fenced Area. The elevated lead hit is the only sample that exceeded the screening level for industrial scenario (1250 mg/kg) at SEAD-71. The next highest concentration within the Fenced Area at SEAD-71 was 572 mg/kg at SS71-19. Subsurface soil samples within the Fenced Area did not have any exceedances. The average lead concentration within the Fenced Area was 350 mg/kg, which was lower than the USEPA (1998) recommended 400 mg/kg screening level for lead in soil at residential properties. Therefore the lead hit is isolated in surface soil within the Fenced Area.

Groundwater

One VOC, two SVOCs, three pesticides, and 18 metals were detected in SEAD-71 groundwater in 2004. No PCBs were detected in SEAD-71 groundwater. 1,1,1-trichloroethane was detected in groundwater but the concentrations were below the NYSDEC Class GA Standard. Two SVOCs were detected in groundwater; bis(2-ethylhexyl)phthalate was detected below the NYSDEC Class GA Standard and 4-nitroaniline was detected below the laboratory reporting limit (8.7 J $\mu\text{g/L}$ vs. 11.1 $\mu\text{g/L}$) while it was above the NYSDEC Class GA guidance value, an identified TBC value (8.7 J $\mu\text{g/L}$ vs. 5 $\mu\text{g/L}$). Three pesticides, 4,4'-DDE, 4,4'-DDT, and endrin ketone, were detected in groundwater but the concentrations were below the NYSDEC Class GA Standards. The concentrations of five metals (aluminum, antimony, iron, manganese, and sodium) exceeded the NYSDEC Class GA Standards or the USEPA Secondary Drinking Water Regulations. No other metals were detected at concentrations that exceeded the identified ARARs or TBCs.

E.2 CONTAMINANT FATE AND TRANSPORT

Soil and groundwater samples collected at SEAD-59/71 showed that the analytes present at SEAD-59/71 are not migrating off-site. Leaching through soil to groundwater with subsequent down-gradient transport within groundwater is a potential transport mechanism for contaminants in soil. However, groundwater monitoring data indicate that groundwater at SEAD-59/71 is not impacted by contaminants in soil. cPAHs and metals, the constituents of potential concern at the sites, are expected to be strongly absorbed/complexed with soil due to their chemical/physical properties. Therefore, mobilization of cPAHs and metals in SEAD-59/71 soil and stockpile soil are expected to be minor.

E.3 HUMAN HEALTH RISK ASSESSMENT

Based on the current and planned future use of the sites, human health risk assessment was performed for three potential receptors:

1. Current/Future Construction Worker. Exposure via the following exposure pathways were evaluated for the construction worker: ingestion of on-site surface and subsurface soil (0-15 ft bgs), dermal contact to on-site surface and subsurface soil, dermal contact to on-site groundwater, intake of groundwater, and inhalation of dusts in ambient air emitted from surface and subsurface soils by the construction activity.
2. Current/Future Industrial Worker. Exposure via the following exposure pathways were evaluated for the industrial worker: ingestion of on-site surface soil (0-2 ft bgs), dermal contact to on-site surface soil, intake of groundwater, and inhalation of dust in ambient air emitted from surface soil.

3. Current Child Trespasser/Future Child Visitor (referred to as child trespasser). Exposure via the following exposure pathways were evaluated for the child trespasser: ingestion of on-site surface soil (0-2 ft bgs), dermal contact to on-site surface soil, intake of groundwater, and inhalation of dust in ambient air emitted from soil.

All soil data representing the current site conditions were included in the risk assessment. Low-flow sampling method was not used for groundwater collected in 1994; therefore the 1994 groundwater data might be overstated by elevated turbidity. However, as a conservative (i.e., health protective) approach, all groundwater data were included in the risk assessment. Exposure point concentrations were based on the upper confidence level (UCL) for soil and the maximum detected concentration for groundwater.

E.3.1 SEAD-59 Human Health Risk Assessment

A summary of the risk assessment results for exposure to SEAD-59 soil and groundwater is presented below.

Risks Based on Reasonable Maximum Exposure (RME) Scenario - SEAD-59 Soil and Groundwater Exposure			
	Industrial Worker	Construction Worker	Child Trespasser/ Child Visitor
Cancer Risk	2×10^{-5}	2×10^{-6}	2×10^{-6}
Hazard Index	0.3	0.5	0.1

USEPA target limits: cancer risk of 10^{-6} – 10^{-4} ; hazard index of 1

The total cancer risks and non-cancer hazard indices based on the RME and CT scenarios for all receptors with exposure to SEAD-59 soil and SEAD-59 groundwater are within the USEPA target limits (i.e., cancer risks below 10^{-4} and hazard index below 1). Therefore, the site poses no significant risks to potential human receptors and no COCs were identified for SEAD-59 soil or SEAD-59 groundwater.

E.3.2 SEAD-59 Stockpile Human Health Risk Assessment

A summary of the risk assessment results for receptors exposed to SEAD-59 Stockpile soil and SEAD-59 groundwater is presented below.

Risks Based on Reasonable Maximum Exposure Scenario - SEAD-59 Stockpile Soil and Groundwater Exposure			
	Industrial Worker	Construction Worker	Child Trespasser/ Child Visitor
Cancer Risk	5×10^{-5}	3×10^{-6}	4×10^{-6}
Health Index	0.2	0.5	0.1

USEPA target limits: cancer risk of 10^{-6} – 10^{-4} ; hazard index of 1

The total cancer risks and non-cancer hazard indices based on the RME and CT scenarios for all receptors with exposure to stockpile soil and SEAD-59 groundwater are within the USEPA target limits. In addition, the lead level in SEAD-59 Stockpile soil does not pose a health risk to the receptors. Therefore, the stockpiles at SEAD-59 pose no significant risks to potential human receptors and no COCs were identified for SEAD-59 Stockpile soil.

Although SEAD-59/71 is planned for future industrial development, risks for potential residents via exposure to stockpile soil were evaluated for screening purposes. Under a CT assumption, the stockpiles at SEAD-59 do not pose unacceptable risks to the residential receptors.

E.3.3 SEAD-71 Human Health Risk Assessment

A summary of the risk assessment results for receptors exposed to SEAD-71 soil and SEAD-71 groundwater is presented below.

Risks Based on Reasonable Maximum Exposure Scenario - SEAD-71 Soil and Groundwater Exposure			
	Industrial Worker	Construction Worker	Child Trespasser/ Child Visitor
SEAD-71			
Cancer Risk	2×10^{-4}	1×10^{-5}	1×10^{-5}
Health Index	3	3	1
SEAD-71 Outside Fenced Area			
Cancer Risk	3×10^{-5}	3×10^{-6}	3×10^{-6}
Health Index	3	3	1

USEPA target limits: cancer risk of 10^{-6} – 10^{-4} ; hazard index of 1

The total cancer risks based on the RME and CT scenarios are below the USEPA upper target limit (1×10^{-4}) for the construction worker and child trespasser. The total cancer risk based on the RME is above the USEPA upper target limit for the industrial worker (2×10^{-4} vs. 1×10^{-4}). PAHs in SEAD-71 soil are the primary COCs contributing to the cancer risks associated with SEAD-71 soil exposure.

The total non-cancer hazard indices based on the RME for all receptors are above or at the USEPA target limit of 1, due to groundwater intake. Risks via all exposure pathways but groundwater intake are below the USEPA target limit of 1. Iron and manganese in SEAD-71 groundwater are the primary COPCs contributing to the elevated non-cancer risks at SEAD-71. The iron and manganese concentrations in SEAD-71 groundwater are generally comparable with the SEDA background. In addition, the iron and manganese concentrations detected in the downgradient monitoring well are consistent with the SEDA background and were not identified as a COCs at the site.

The elevated PAH concentrations within the Fenced Area are not expected to be associated with any release at the site based on the following facts:

- Elevated PAH concentrations detected in surface soil within the Fenced Area are likely caused by asphalt materials in the hard fill and oil used in the construction of the area. At the time of construction, the Army typically utilized hard fill consisting of oiled crushed stone to form a sturdy base for areas subjected to heavy vehicular traffic and storage operations. The presence of this material is noted in the sampling and boring logs for this area. The oil was used to help in the compaction of the crushed stone and aided in dust suppression. The likely cause of the consistent elevated PAH concentrations throughout the Fenced Area is asphalt materials in the hard fill and oil used in the construction of the area.
- The soil underneath the pavement is not impacted by PAHs; and
- The Fenced Area is not associated with any CERCLA release.

Therefore, a baseline risk assessment was also conducted for SEAD-71 outside the Fenced Area and the results are presented in the above table and summarized below.

Cancer risks are below the USEPA upper target limit for all receptors for both the RME and CT scenarios. Therefore, PAHs in SEAD-71 soil are not identified as COCs at the site.

A lead risk characterization conducted for SEAD-71 indicates that the lead levels in SEAD-71 soil and groundwater are not expected to pose a health risk to the receptors.

E.4 SCREENING-LEVEL ECOLOGICAL RISK ASSESSMENT

A screening-level ecological risk assessment (SLERA) was conducted for SEAD-59 and SEAD-71 including a screening-level problem formulation and risk calculation (Steps 1 and 2 as described in the USEPA1997 ERAGS) and a further refinement of Contaminants of Concern (COCs) (Step 3.2).

COPCs were identified in the SLERA by comparing the maximum detected concentrations with available screening benchmark values. Ecological receptors identified for the sites (i.e., deer mouse, American robin, short-tailed shrew, and red fox) are potentially exposed to COPCs in surface soil (0-

2 ft bgs) via soil ingestion and biota intake. To assess both potential future site conditions and burrowing and/or deep-rooted plant impacts, exposure to the deeper soil interval (0 to 4 ft bgs) was also evaluated. Exposure to groundwater was not deemed a complete pathway and therefore was not evaluated in the SLERA. The potential for exposure via completed pathways was inferred based on the maximum detected concentration in soil, estimated contaminant uptake and assimilation by vegetation and prey species, and on the bioaccumulation and biomagnification properties of the contaminants.

E.4.1 SEAD-59 SLERA

Based on the risk estimates for the SLERA, one PAH (phenanthrene), two pesticides (4,4'-DDE and 4,4'-DDT), and several metals (antimony, arsenic, cadmium, cobalt, lead, silver, thallium, and vanadium) in SEAD-59 soil were identified as preliminary COCs as the associated HQs were at least one for one or more receptors. The screening level risk calculation results are summarized as follows.

- HQs based on the NOAEL SEVs are below 1 for the avian receptor (American robin) exposed to all COCs in SEAD-59 soil with the exception of 4,4'-DDE, 4,4'-DDT and lead. The HQs for the American robin exposed to 4,4'-DDT in SEAD-59 surface and total soil are approximately 700. The HQs for the American robin exposed to 4,4'-DDE are slightly above one at two. The HQs for the American robin exposed to lead are at one.
- HQs based on the NOAEL SEVs are below 1 for the high trophic level mammal (red fox) exposed to all COCs in SEAD-59 soil with the exception of antimony.
- Exposure to the maximum detected concentrations of 4,4'-DDT and three metals (antimony, arsenic, and vanadium) in SEAD-59 soil by the deer mouse results HQs greater than one based on the NOAEL SEVs. The HQ associated with exposure to the maximum detected concentration of 4,4'-DDE, cadmium, and cobalt in soil is at one for the deer mouse.
- Exposure to the maximum detected concentrations of 4,4'-DDT and five metals (antimony, arsenic, cobalt, thallium, and vanadium) in SEAD-59 soil by the short-tailed shrew results HQs greater than one based on the NOAEL SEVs. The HQs associated with exposure to the maximum detected concentration of phenanthrene, 4,4'-DDE, cadmium, and silver in soil are at one for the short-tailed shrew.
- HQs resulted from the maximum detected concentrations of PAHs in SEAD-59 soil are all below 1 for all receptors except that the HQs for short-tailed shrew exposed to phenanthrene in SEAD-59 are at 1. Therefore, PAHs in SEAD-59 soil are unlikely to cause adverse ecological effects.

The preliminary COCs identified based on the SLERA results were further refined based on the alternative risk results characterized by using the average concentrations and/or LOAEL SEVs. The alternative risks based on the average concentrations and LOAEL SEVs are all below or at 1 for all

the preliminary COCs. In addition, the concentrations of the preliminary inorganic COCs are consistent with SEDA background. Further, SEAD-59 is located in the PID parcel and the site is not expected to support, sustain, or attract ecological receptors and therefore is not expected to be a wildlife habitat. Based on the above facts, it is the Army's position that no further action is warranted at SEAD-59 to mitigate potential risks to ecological receptors.

E.4.2 SEAD-59 Stockpile SLERA

Based on the risk estimates for the screening level ERA, one pesticide (4,4'-DDT), one PAH (pyrene), and five metals (antimony, arsenic, lead, silver, and vanadium) in SEAD-59 Stockpile soil were identified as preliminary COCs as the associated HQs were at least one for one or more receptors. The screening level risk calculation results are summarized as follows.

- HQs based on the NOAEL SEVs are below 1 for the avian receptor (American robin) exposed to all COPCs in SEAD-59 Stockpile soil with the exception of 4,4'-DDT and lead.
- HQs based on the NOAEL SEVs are below 1 for the high trophic level mammal (red fox) exposed to all COPCs in SEAD-59 Stockpile soil with the exception of antimony.
- Exposure to the maximum detected concentrations of four metals (antimony, arsenic, lead, and vanadium) in SEAD-59 Stockpile soil by the deer mouse results HQs greater than one based on the NOAEL SEVs. The HQ associated with exposure to the maximum detected concentration of silver in stockpile soil is at one for the deer mouse.
- Exposure to the maximum detected concentrations of five metals (antimony, arsenic, lead, silver, and vanadium) in SEAD-59 Stockpile soil by the short-tailed shrew results in HQs greater than one based on the NOAEL SEVs. The HQ associated with exposure to the maximum detected concentration of pyrene in stockpile soil is at one for the short-tailed shrew.
- HQs resulted from the maximum detected concentrations of all PAHs but pyrene in SEAD-59 Stockpile soil are all below 1 for all receptors. Therefore, PAHs in SEAD-59 Stockpile soil are unlikely to cause adverse ecological effects.

The preliminary COCs identified based on the SLERA results were further refined based on the alternative risk results characterized by using the average concentrations and/or LOAEL SEVs. The alternative risks based on the average concentrations and LOAEL SEVs are all below or at 1 for all the preliminary COCs. In addition, the concentrations of the preliminary inorganic COCs are consistent with SEDA background with the exception of lead. Further, SEAD-59 is located in the PID parcel and the site is not expected to support, sustain, or attract ecological receptors and therefore is not expected to be a wildlife habitat. Based on the above facts, it is the Army's position that no further action is warranted at SEAD-59 to mitigate potential risks to ecological receptors.

E.4.3 SEAD-71 SLERA

The elevated PAH concentrations in surface soil within the Fenced Area at SEAD-71 are not associated with any release at the site. Therefore, a screening level ecological risk assessment was conducted for SEAD-71 by using all soil data from outside the Fenced Area.

Based on the risk estimates for the SLERA, six PAHs (benzo(a)anthracene, benzo(a)pyrene, benzo(b)fluoranthene, chrysene, phenanthrene, and pyrene), one pesticide (4,4'-DDT), and several metals (antimony, arsenic, lead, thallium, vanadium, and zinc) in SEAD-71 soil (outside the Fenced Area) were identified as preliminary COCs as the associated HQs were at least one for one or more receptors. The results are summarized below.

- HQs based on the NOAEL SEVs are below 1 for the high trophic level mammal (red fox) exposed to all COCs in SEAD-71. Therefore, the high trophic level mammals are unlikely impacted by the soil outside the Fenced Area at SEAD-71.
- HQs based on the NOAEL SEVs are below 1 for the avian receptor (American robin) exposed to all COCs in soil outside the Fenced Area at SEAD-71 with the exception of 4,4'-DDT, lead, and zinc.
- Deer mouse exposure to the maximum detected concentrations of phenanthrene, pyrene, lead, and zinc in soil outside the Fenced Area results in a slightly elevated HQ at 2. In addition, HQs for the deer mouse exposed to antimony, arsenic, and vanadium, in SEAD-71 soil outside the Fenced Area are greater than one based on the NOAEL SEVs. The HQs associated with exposure to the maximum detected concentration of thallium in soil outside the Fenced Area is at one for the deer mouse. HQs for the deer mouse exposed to the other COCs are below one.
- Exposure to the maximum detected concentrations of two PAHs (phenanthrene and pyrene) and six metals (antimony, arsenic, lead, thallium, vanadium, and zinc) in SEAD-71 soil outside the Fenced Area by the short-tailed shrew results HQs greater than one based on the NOAEL SEVs. The HQs associated with exposure to the maximum detected concentrations of four PAHs (benzo(a)anthracene, benzo(a)pyrene, benzo(b)fluoranthene, and chrysene) are at one for the short-tailed shrew.

Based on the results of the further refinement of COCs (part of Step 3), no COCs were identified for SEAD-71 soil for ecological receptors. Further, SEAD-71 is located in the PID parcel and the site is not expected to support, sustain, or attract ecological receptors and therefore is not expected to be a wildlife habitat. Based on the above facts, it is the Army's position that no further action is warranted at SEAD-71 to mitigate potential risks to ecological receptors.

E.5 RECOMMENDATIONS

The baseline human health risk assessment and the screening level ecological risk assessment conducted for the sites indicate that the sites pose no significant risk to human health or the environment. Recommendations are as follows:

- Apply institutional controls in the form of land use restrictions on SEAD-59 and SEAD-71 as described in the Final Record of Decision for Sites Requiring Institutional Controls in the Planned Industrial/Office Development or Warehousing Areas (Parsons, 2004), signed on September 28, 2004 by USEPA:
 - Prohibit the development and use of property for residential housing, elementary and secondary schools, childcare facilities and playgrounds.
 - Prevent access to or use of groundwater until the Class GA Groundwater Standards are met.
- Proceed with Proposed Plan and Record of Decision for these sites.
- The stockpile soil at SEAD-59 is suitable for use as fill or grading material.

1.0 INTRODUCTION

This report presents the Phase II Remedial Investigation (RI) activities and the evaluation of the current conditions of the Fill Area West of Building 135 (SEAD-59) and the Alleged Paint Disposal Area (SEAD-71) at the Seneca Army Depot Activity (SEDA) in Romulus, New York. The purpose of this Phase II Remedial Investigation Report is to complete the RI process at SEAD-59 and SEAD-71.

This report presents and evaluates the data characterizing the current site conditions and aims to determine whether or not any future actions are warranted at SEAD-59 or SEAD-71. This Phase II RI report completes the RI process by presenting and evaluating data representative of current site conditions collected from the Phase I and pre-Phase I investigations (i.e. Expanded Site Inspection (ESI) and Phase I RI), the 2002 time-critical removal action (TCRA), and the 2004 groundwater monitoring program. These data are combined to determine if any residual impacts on human health or ecological risks exist at the sites. The evaluation of the data characterizing the current site conditions is used to determine what future actions, if any, are warranted at the sites.

1.1 REPORT ORGANIZATION

The remainder of this section provides a general description of SEAD-59 and SEAD-71 including site background, geology, hydrogeology, and land use. **Section 2** summarizes the previous site investigations including ESI and Phase I investigations and the TCRA presented in previous reports. **Section 3** summarizes the data representative of current site conditions, and an overview of the 2004 groundwater monitoring activities. This information has not been presented in any reports. **Section 4** presents the nature and extent of contamination present at SEAD-59 and SEAD-71 (hereafter referred to as the “sites”). **Section 5** discusses the fate and transport of contaminants remaining at the sites. **Sections 6** and **7** present the baseline human health risk assessment and environmental risk assessment conducted on contaminants left on the sites. **Section 8** presents the conclusions and recommendations for SEAD-59 and SEAD-71. Appendices A through L provide data in support of the information presented in this report.

1.2 SENECA ARMY DEPOT PROJECT BACKGROUND

SEDA is located approximately 40 miles south of Lake Ontario, near Romulus, New York (NY) as shown in **Figure 1-1**. The Depot lies immediately west of the village of Romulus, NY, 12 miles south of the villages of Waterloo and Seneca Falls, and 2.5 miles north of the village of Ovid, NY. The two closest major cities are Rochester, NY, which is located approximately 60 miles northwest, and Syracuse, NY, which is located approximately 60 miles northeast.

SEDA is located in an uplands area, where the elevation ranges from approximately 600 feet (ft.) National Geodetic Vertical Datum (NGVD 1929) along the western boundary of the Depot to nearly 760 feet NGVD 1929 in the central portion of the eastern boundary. The uplands area where SEDA is located forms a divide separating two of the New York Finger Lakes: Cayuga Lake on the east and Seneca Lake on the west. Sparsely populated farmland covers most of the surrounding area. New York State Highways 96 and 96A border SEDA to the east and west, respectively. **Figure 1-2** presents a plan view of SEDA.

The 10,587-acre SEDA facility has been owned by the United States Government since 1941 and was operated by the Department of the Army (DOA) until 2001. From its inception in 1941 until 1995, SEDA's primary mission was the receipt, storage, maintenance, and supply of military items, including munitions and equipment. Seneca Army Depot was proposed to be included on the National Priorities List (NPL) on July 14, 1989. Once Seneca Army Depot was listed on the NPL, the Army, United States Environmental Protection Agency (USEPA), and New York State Department of Environmental Conservation (NYSDEC) identified a list enumerating 57 solid waste management units (SWMUs) where historic data or information suggested, or evidence existed to support, that hazardous materials or hazardous wastes had been handled and may have possibly been released and migrated into the environment. Each of these sites was identified in the Federal Facilities Agreement (FFA) signed by the three parties in 1993, and this list subsequently expanded to include 72 sites. Activities at the SEDA are regulated by the Comprehensive Environmental Response, Compensation, and Liability Act of (CERCLA) and Resource Conservation and Recovery Act (RCRA). USEPA and NYSDEC are the approval entities for the project. The site number is listed as NY0213820830 and 8-50-006 under the USEPA and NYSDEC program, respectively.

The Depot's mission changed in early 1995 when the Department of Defense (DoD) recommended closure of the SEDA under the Base Realignment and Closure (BRAC) process. This recommendation was approved by Congress on September 28, 1995, and the Depot was closed by July 2001.

1.3 SEAD-59/71 SITE BACKGROUND

This section provides a brief overview of SEAD-59 and SEAD-71. The sites were evaluated in 1994 as part of an Army effort to determine the conditions at several SWMUs that were considered to potentially pose a threat to human health and the environment.

1.3.1 SEAD-59

SEAD-59 (Fill Area West of Building 135) is located in the east-central portion of SEDA (**Figure 1-3**). SEAD-59 is approximately 4 acres in size and the site encompasses an area along both sides of an unnamed dirt road that provides access to Building 311 and runs perpendicular to the south side of

Administration Avenue terminating at Building 311. Prior to the 2002 TCRA, the area to the south of the road was relatively flat and sloped gently to the west, while the area to the north of the road contained a fill area with approximately 10 feet of relief. The area to the south was covered with vegetation. The area to the north contained waste piles and had stressed vegetation. The 2002 TCRA altered the area north of the access road significantly and the area now has a 5-foot relief sloping to the northwest. The area south of the access road was graded to approximately the original site grade.

The entire western border of the site is defined by a north-south trending drainage ditch. A drainage swale that is oriented east-to-west and parallels the railroad tracks forms the northern boundary of SEAD-59. At the northwestern corner of the site, the drainage swale turns to the north and passes under the railroad tracks. Drainage ditches are also located on each side of the access road to Building 311 and the ditches are sloped from east-to-west and promote flow into the drainage ditch in the western portion of the site.

SEAD-59 was used for the disposal of construction debris and oily sludges. SEDA personnel had indicated that there may have been a large quantity of miscellaneous "roads and grounds" waste buried at the site. It is not known when the disposal took place.

1.3.2 SEAD-71

SEAD-71 (the Alleged Paint Disposal Area) is located in the east-central portion of SEDA. The site is located west of the 4th Avenue near Buildings 127 and 114 (see **Figures 1-2 and 1-4**). The entire site is approximately 2 acres and bounded on the north and south by railroad tracks serving Buildings 114 and 127. The topography is relatively flat with a gentle slope to the southwest.

A Fenced Area surrounded by a chain-link fence is situated between Buildings 114 and 127 and a single railroad track bisects the area west to east. The area is generally paved over or covered with crushed stone and pieces of asphalt and concrete were observed on the ground surface. Additional railroad tracks run west to east along Buildings 114 and 127 and abut the Fenced Area on the north and south.

It is rumored that paints and/or solvents were disposed at SEAD-71 in burial pits. It is not known what other activities occurred at the site. No dates of disposal are available nor is there any information on the number of suspected disposal pits.

The storage areas north and east of the site contain numerous white transformers, large spools of cable, and other assorted equipment. South of the site are SEDA railroad tracks that served Building 122. West of the site is a grassy area that is interrupted by a gravel roadway, and an east-west trending SEDA railroad track that cuts through the middle of the storage areas and forms the northern boundary of the site.

1.4 ENVIRONMENTAL SETTING

This section examines geology, hydrogeology, current and future land uses, topography, and climate at SEAD-59/71.

1.4.1 Geology

Regional Geology

The Finger Lakes uplands area is underlain by a broad north-to-south trending series of rock terraces mantled by glacial till. As part of the Appalachian Plateau, the region is underlain by a tectonically undisturbed sequence of Paleozoic rocks consisting of shales, sandstones, conglomerates, limestones and dolostones. **Figure 1-5** shows the regional geology of Seneca County. In the vicinity of SEDA, Devonian age (385 million years ago) rocks of the Hamilton Group are monoclinally folded and dip gently to the south. No evidence of faulting or folding is present. The Hamilton Group is a sequence of limestones, calcareous shales, siltstones, and sandstones.

These rocks were deposited in a shallow inland sea at the north end of the Appalachian Basin (Gray, 1991). Terrigenous sediments from topographic highs associated with the Arcadian landmass of western New England, eastern New York and Pennsylvania were transported to the west across a marine shelf (Gray, 1991). These sediments were deposited in a northeast-southwest trending trough whose central axis was near what are now the Finger Lakes (Gray, 1991).

The Hamilton Group, 600 to 1,500 feet thick, is divided into four formations. They are, from oldest to youngest, the Marcellus, Skaneateles, Ludlowville, and Moscow formations. The western portion of SEDA is generally located in the Ludlowville Formation while the eastern portion is located in the younger Moscow Formation. The Ludlowville and Moscow formations are characterized by gray, calcareous shales and mudstones and thin limestones with numerous zones of abundant invertebrate fossils that form geographically widespread encrinites, coral-rich layers, and complex shell beds. The Ludlowville Formation is known to contain brachiopods, bivalves, trilobites, corals and bryozoans (Gray, 1991). In contrast, the lower two formations (Skaneateles and Marcellus) consist largely of black and dark gray sparsely fossiliferous shales (Brett et al., 1991). Locally, the shale is soft, gray, and fissile. **Figure 1-6** displays the stratigraphic section of Paleozoic rocks of Central New York. The shale is extensively jointed and weathered at the contact with overlying tills. Joint spacings are 1 inch to 4 feet in surface exposures. Prominent joint directions are N 60° E, N 30° W, and N 20° E, with the joints being primarily vertical. Corings performed on the upper 5 to 8 feet of the bedrock revealed low Rock Quality Designations (RQD's), i.e., less than 5 percent with almost 100 percent recovery (Metcalf & Eddy, 1989), suggesting a high degree of weathering.

Pleistocene age (Wisconsin event, 20,000 years ago) glacial till deposits overlies the shales. **Figure 1-7**, the physiography map of Seneca County, presents an overview of the subsurface sediments present in the area. SEDA is shown as lying on the western edge of a large glacial till plain between Seneca Lake

and Cayuga Lake. The till matrix, the result of glaciation, varies locally but generally consists of horizons of unsorted silt, clay, sand, and gravel. The soils at SEDA contain varying amounts of inorganic clays, inorganic silts, and silty sands. In the central and eastern portions of SEDA, the till is thin and bedrock is exposed or within 3 feet of the surface. The thickness of the glacial till deposits at SEDA generally ranges from 1 to 15 feet.

Darien silt-loam soils, 0 to 18 inches thick, have developed over Wisconsin age glacial tills. These soils are developed on glacial till where they overlie the shale. In general, the topographic relief associated with these soils is from 3 to 8 percent. **Figure 1-8** presents the U.S. Department of Agriculture (USDA) General Soil map for Seneca County.

SEDA Geology

SEDA geology is characterized by gray Devonian shale with a thin weathered zone where it contacts the overlying mantle of Pleistocene glacial till. This stratigraphy is consistent over the entire SEDA facility. The predominant surficial geologic unit present at the site is dense glacial till. The till is distributed across the entire facility and ranges in thickness from less than 2 feet to as much as 15 feet although it is generally only a few feet thick. The till is generally characterized by brown to gray-brown silt, clay and fine sand with few fine to coarse gravel-sized inclusions of weathered shale. Larger diameter weathered shale clasts (as large as 6-inches in diameter) are more prevalent in basal portions of the till and are probably ripped-up clasts removed by the active glacier.

The general Unified Soil Classification System (USCS) description of the till at SEDA is as follows: Clay-silt, brown; slightly plastic, small percentage of fine to medium sand, small percentage of fine to coarse gravel-sized gray shale clasts, dense and mostly dry in place, till, (ML). Grain size analyses performed by Metcalf & Eddy (1989) on glacial till samples collected during the installation of monitoring wells at SEDA show a wide distribution of grain sizes. The glacial tills have a high percentage of silt and clay with trace amounts of fine gravel. Another study, conducted at the same location by the United States Army Environmental Hygiene Agency (USAEHA) determined the porosities of 5 gray-brown silty clay (i.e., till) samples. The porosities of the till samples ranged from 34.0 percent to 44.2 percent with an average of 37.3 percent (USAEHA Hazardous Waste Study No. 37-26-0479-85).

Darien silt-loam soils, 0 to 18 inches thick, have developed over the till; however, in some locations, the agricultural soils have been eroded away and the till is exposed at the surface. The surficial soils are poorly drained and have a silt clay loam and clay subsoil. In general, the topographic relief associated with these soils is from 3 to 8%. A zone of gray weathered shale of variable thickness is present below the till in almost all locations drilled at SEDA. This zone is characterized by fissile shale with a large amount of brown interstitial silt and clay.

The bedrock underlying the site is composed of the Ludlowville Formation of the Devonian age, Hamilton Group. Merin (1992) also cites three prominent vertical joint directions of northeast, north-northwest, and east-northeast in outcrops of the Genesee Formation 30 miles southeast of SEDA near Ithaca, New York. Three predominant joint directions, N60°E, N30°W, and N20°E are present within this unit (Mozola, 1951). These joints are primarily vertical. The Hamilton Group is a gray-black, calcareous shale that is fissile and exhibits parting (or separation) along bedding planes.

SEAD-59 Soils

Based on the results of the drilling program conducted during the ESI at SEAD-59, fill material, till, weathered dark gray shale, and competent gray-black shale are the four major geologic units present on-site. At most of the boring locations, very little topsoil was present. Several of the borings were drilled on a gravel surface, and no topsoil was encountered at these locations.

Fill material was encountered in the borings located within the fill area north of the access road. The fill was characterized as being lithologically similar to the underlying till: it was characterized as silt containing minor components of sand and shale fragments, but was noted as being different from the till in color, which tended to be gray brown or tan, and due to the presence of gravel, asphalt, wood and other organic material. The fill was found to extend to a depth of 10~11 feet in select places.

The till was characterized as light brown in color and composed of silt, very fine sand, and clay, with minor components of gray-black shale fragments. Larger shale fragments (rip-up clasts) were observed at some locations at the top of the weathered shale. The thickness of the till ranged from approximately 3 to 9 feet.

The weathered shale that forms the transition between till and competent shale was encountered at five of the nine boring locations. Competent gray-black shale was observed at two spots at 8.0 and 10.5 feet below grade, respectively. At the remaining boring locations, bedrock was inferred from the point of auger or spoon refusal at depths ranging from 10 to 21 feet below grade.

SEAD-71 Soils

Based on the results of the subsurface exploration conducted during the ESI at SEAD-71, till, calcareous weathered shale, and competent shale are the three major types of geologic materials present on-site. The till in the Fenced Area was characterized as olive gray clay with little silt, very fine sand, and shale fragments (up to 1 inch in diameter) and ranged in thickness from 5 to 8 feet. In the southern section of the Fenced Area, the till consisted of light brown silt with little clay and trace amounts of shale fragments (up to 1 inch in diameter). Large shale fragments (rip-up clasts) were observed at or near the till/weathered shale contact at all soil boring locations. In the western half of the site, the till consisted of olive gray silt and was found to be approximately 4 feet thick.

The weathered shale that forms the transition between the till and competent shale was encountered at all soil boring and test pit locations. The depth of the weathered shale ranged from approximately 5 to 8 feet below ground surface (bgs). Competent, calcareous gray shale was encountered at depths between 5 and 9 feet bgs.

1.4.2 Hydrogeology

Regional Hydrology/Hydrogeology

Regionally, four distinct hydrologic units have been identified within Seneca County (Mozola, 1951). These include two distinct shale formations, a series of limestone units, and unconsolidated beds of Pleistocene glacial drift. Overall, the groundwater in the county is very hard, and therefore, the quality is minimally acceptable for use as potable water.

Approximately 95 percent of the wells in the county are used for domestic or farm supply and the average daily withdrawal is approximately 500 gallons, an average rate of 0.35 gallons per minute (gpm). About five percent of the wells in the county are used for commercial, industrial, or municipal purposes. Seneca Falls and Waterloo, the two largest communities in the county, are in the hydrogeologic region which is most favorable for the development of a groundwater supply. However, because the hardness of the groundwater is objectionable to the industrial and commercial establishments operating within the villages, both villages utilize surface water (Cayuga Lake and Seneca River, respectively) as their municipal supplies. The villages of Ovid and Interlaken, both of which are without substantial industrial establishments, utilize groundwater as their public water supplies. Ovid obtains its supply from two shallow gravel-packed wells, and Interlaken is served by a developed seepage-spring area.

Regionally, the water table aquifer of the unconsolidated surficial glacial deposits of the region would be expected to flow in a direction consistent with the ground surface elevations. Geologic cross-sections from Seneca Lake and Cayuga Lake have been constructed by the State of New York, (Mozola, 1951, and Crain, 1974). The geologic cross-sections suggest that a groundwater divide exists approximately half way between the two Finger Lakes. SEDA is located on the western slope of this divide and therefore regional groundwater flow is expected to be primarily westward towards Seneca Lake.

A substantial amount of information concerning the hydrogeology of the area has been compiled by the State of New York (Mozola, 1951). No other recent state sponsored hydrogeological report is available for review. The report has been reviewed in order to better understand the hydrogeology of the area surrounding SEDA. The data indicate that within a four-mile radius of the site a number of wells exist from which geologic and hydrogeologic information has been obtained. This information includes: (1) the depth; (2) the yield; and (3) the geological strata through which the wells were drilled. Although the information was compiled in the 1950s, these data are useful in providing an understanding and characterization of the aquifers present within the area surrounding SEDA. A review of this information suggests that three geologic units have been used to produce water for both domestic and agricultural

purposes. These units include: (1) a bedrock aquifer, which in this area is predominantly shale; (2) an overburden aquifer, which includes Pleistocene deposits (glacial till); and (3) a deep aquifer present within beds of limestone in the underlying shale. The occurrence of water derived from limestone is considered to be unusual for this area and is more commonplace to the north of SEDA. The limestone aquifer in this area is between 100 and 700 feet deep. As of 1957, twenty-five wells utilized water from the shale aquifer, six wells tapped the overburden aquifer, and one used the deep limestone as a source of water.

For the six wells that utilized groundwater extracted from the overburden, the average yield was approximately 7.5 gpm. The average depths of these wells were 36 feet. The geologic material that comprises this aquifer is generally Pleistocene till, with the exception of one well located northeast of SEDA. This well penetrates an outwash sand and gravel deposit. The yields from the five overburden wells ranged from 4 to 15 gpm. The well located in the outwash sand and gravel deposit, drilled to 60 feet, yielded only 5 gpm. A 20-foot hand dug well, located southeasterly of the outwash well, yielded 10 gpm.

The geologic information reviewed indicates that the upper portions of the shale formation would be expected to yield small, yet adequate, supplies of water, for domestic use. For mid-Devonian shales such as those of Hamilton group, the average yields (which are less than 15 gpm) are consistent with what would be expected for shales (LaSala, 1968). The deeper portions of the bedrock, (at depths greater than 235 feet) have provided yields up to 150 gpm. At these depths, the high well yields may be attributed to the effect of solution on the Onondaga limestone which is at the base of the Hamilton Group. Based on well yield data, the degree of solution is affected by the type and thickness of overlying material (Mozola, 1951). Solution effects on limestones (and on shales which contain gypsum) in the Erie-Niagara have been reported by LaSala (1968). This source of water is considered to comprise a separate source of groundwater for the area. Very few wells in the region adjacent to SEDA utilize the limestone as a source of water, which may be due to the drilling depths required to intercept this water.

Local Hydrology/Hydrogeology

Local hydrogeology is overall consistent with the regional hydrogeology.

Surface drainage from SEDA flows to five primary creeks (see **Figure 1-2**). In the southern portion of the Depot, the surface drainage flows through man-made drainage ditches and streams into Indian and Silver Creeks. These creeks then merge and flow into Seneca Lake just south of the SEDA airfield. The central part and administration area of the SEDA drain into Kendaia Creek. Kendaia Creek flows in a predominant westerly direction, and discharges into Seneca Lake at a location north of Pontius Point and the SEDA's Lake Shore Housing Area. The majority of the northwestern and north-central portion of the SEDA drains into Reeder Creek. Reeder Creek flow predominantly northwesterly and leaves the Depot at a point that is north of the Open Detonation Area (i.e., SEAD-45) and west of the former Weapons Storage Area or the "Q" (i.e., SEAD-12) before it turns to the west and flows into Seneca

Lake. The northeastern portion of the Depot, which includes a marshy area called the Duck Pond, drains into Kendig Creek and then flows north into the Cayuga-Seneca Canal and to Cayuga Lake. Other minor creeks are also present and drain portions of the Depot.

Data from various SEDA site quarterly groundwater monitoring programs indicate that the saturated thickness of the till/weathered shale overburden aquifer is variable, ranging between 1 and 9 feet. However, the aquifer's thickness appears to be influenced by the hydrologic cycle and some monitoring wells dry up completely during portions of the year. Based upon a review of two years of data, the variations of the water table elevations are likely a seasonal phenomenon. The overburden aquifer is thickest during the spring recharge months and thinnest during the summer and early fall. During late fall and early winter, the saturated thickness typically increases. Although rainfall is fairly consistent at SEDA, averaging approximately 3 inches per month, evapo-transpiration is a likely reason for the large fluctuations observed in the saturated thickness of the over-burden aquifer.

SEAD-59 Hydrogeology

As part of the ESI program, three monitoring wells were installed at SEAD-59 and three wells were installed at SEAD-5. SEAD-5 is located immediately adjacent to SEAD-59, just east of the area that is to the south of the access road. The groundwater flow direction in the overburden aquifer at SEAD-59 was towards the southwest based on groundwater elevations measured in the three monitoring wells at SEAD-59 and the three monitoring wells at SEAD-5 on July 6, 1994 (see **Table 1-1** and **Figure 1-9**).

Two monitoring wells were installed during the Phase II RI and three monitoring wells were installed during the 2002 TCRA. The groundwater flow direction based on the 2004 measurements of groundwater elevation levels is presented in **Figure 1-9A**. It confirms that the groundwater flow direction in the overburden aquifer at SEAD-59 is towards the west-southwest. The distribution of groundwater in the overburden aquifer was characterized by saturated soil in the lower till strata and the weathered shale. At SB59-1, where the fill directly overlaid bedrock, the lower portion of the fill material was saturated. Recharge to the monitoring wells during the 2004 sampling events was sufficient for sampling purposes.

SEAD-71 Hydrogeology

As part of the ESI program, three monitoring wells were installed at SEAD-71. The groundwater flow direction in the till/weathered shale aquifer on the site was to the west-southwest based on groundwater elevations measured in the three monitoring wells on July 6, 1994 and July 26, 1994 (see **Table 1-2** and **Figure 1-10**).

An additional monitoring well was installed during the 2002 TCRA. The groundwater flow direction based on the 2004 measurements of groundwater elevation levels is presented in **Figure 1-9A**. It

confirms that the groundwater flow direction in the overburden aquifer at SEAD-71 is towards the west-southwest. Recharge of water to the monitoring wells during the 2004 groundwater sampling events was generally poor.

SEAD-59 Surface-Water Hydrology

Surface water flow from precipitation events is controlled by the local topography. The area to the south of the access road slopes gently to the west. Surface water flow in this area is to the west and it is most likely captured by the north-south trending drainage swale located in the western portion of the site and by the drainage ditch that parallels the south side of the access road.

Prior to the 2002 TCRA, the area north of the access road was a hill composed of fill material with approximately 10 feet of vertical relief. To the west, the hill sloped steeply to the north-south trending drainage swale, which flows north and eventually flows under the railroad tracks north of the site. To the north, the hill sloped to a sustained drainage ditch that is approximately two feet deep. This ditch originates east of the site near Building 128 and flows west, paralleling the railroad tracks and the northern boundary of SEAD-59. At the northwestern corner of the site, the drainage swale turns to the north and passes under the railroad tracks. To the east, the hill sloped downward to a graded gravel surface used for storage of large equipment. Surface water from this area also drains into the northern drainage swale, flowing along the northern boundary of the site, as described above. To the south, the hill sloped to the access road that runs through the site. Surface water from this southern portion of the hill drained into the drainage ditch that parallels the access road on the north side. Water captured by this drainage ditch flows west and intersects the north flowing drainage ditch in the western portion of SEAD-59.

As a result of excavation and backfilling operations during the 2002 TCRA, the topography of the area north of the access road was altered. The area was backfilled to form a hill with 5 feet of vertical relief and slopes to the northwest. The new topography is not expected to dramatically change the surface water conditions at the Site since the drainage ditch system has not been altered.

SEAD-71 Surface-Water Hydrology

Surface water flow from precipitation events is controlled by local topography, although there is little topography relief on the site. There are no sustained surface water bodies on-site. In the Fenced Area, the asphalt provides an impermeable surface that results in increased amount of surface water runoff on the site. Based on topography relief, surface water flow is to the west-northwest. Along the southern boundary of the site, surface water flows toward the SEDA railroad tracks (to the south), which are topographically lower than the site.

The 2002 TCRA did not alter the site topography. Excavated areas were backfilled to the original grading as part of the Army's request. Surface water run-off quantities are not expected to change since the topography and site groundcover have not been dramatically altered.

1.4.3 Regional/Local Land Use

SEDA Base

SEDA is situated between Seneca Lake and Cayuga Lake and encompasses portions of Romulus and Varick Townships. Land use in this region of New York is largely agricultural, with some forestry and public land (school, recreational and state parks). The most recent land use report was issued by Cornell University (Cornell 1967). This report classifies land uses and environments of this region in further detail. Agricultural land use is categorized as inactive and active use. Inactive agricultural land consists of land committed to eventual forest regeneration, land waiting to be developed, or land presently under construction. Active agricultural land surrounding SEDA consists largely of cropland and cropland pasture.

Forest land adjacent to SEDA is primarily under regeneration with sporadic occurrence of mature forestry. Public and semi-public land use surrounding and within the vicinity of SEDA includes Sampson State Park, Willard Psychiatric Center, and Central School (at the Town of Romulus). Sampson State Park entails approximately 1,853 acres of land and includes a boat ramp on Seneca Lake. Historically, Varick and Romulus Townships within Seneca County were developed as an agricultural center supporting a rural population. However, increased population occurred in 1941 due to the opening of SEDA. Population has progressed since then largely due to the increased emphasis on promoting tourism and recreation in this area.

The 10,587-acre SEDA facility was constructed in 1941 and has been owned by the United States Government and operated by the DOA since that date. From its inception in 1941 until 1995, SEDA's primary mission was the receipt, storage, maintenance, and supply of military items, including munitions and equipment. The Depot's mission changed in early 1995 when the DOD recommended closure of the SEDA under its BRAC process. This recommendation was approved by Congress on September 28, 1995 and the Depot was closed by July 2001.

In accordance with the requirements of the BRAC process, the Seneca County Board of Supervisors established the Seneca Army Depot Local Redevelopment Authority (LRA) in October 1995. The primary responsibility assigned to the LRA was to plan and oversee the redevelopment of the Depot. The Reuse Plan and Implementation Strategy for Seneca Army Depot was adopted by the LRA and approved by the Seneca County Board of Supervisors on October 22, 1996. Under this plan and subsequent amendment, areas within the Depot were classified as to their most likely future use. These areas included: housing, institutional, industrial, an area for the existing navigational LORAN transmitter, recreational/conservation and an area designated for a future prison. The Seneca County

Industrial Development Authority re-classified the future land use for SEDA in June 2005. The present future land uses for the Depot are shown in **Figure 1-11**.

SEAD-59 and SEAD-71

As shown in **Figure 1-11**, the LRA has established that the area encompassing SEAD-59 and SEAD-71 is the Planned Industrial Development (PID) parcel. At the time when these sites are relinquished by the Army, the Army will ensure that both sites can be used for the intended purpose.

Currently, the PID area surrounding SEAD-59 and SEAD-71 is undergoing transfer from the Army for industrial development. SEAD-59 and SEAD-71, because they are subject to ongoing investigations, are currently retained by the Army pending completion of the CERCLA process. The Army intends to place institutional controls in the form of land use restrictions on the PID parcel and these restrictions would eventually apply to SEAD-59 and SEAD-71. As described in the Final Record of Decision (ROD) for Sites Requiring Institutional Controls in the Planned Industrial/Office Development or Warehousing Areas (Parsons, 2004), signed on September 28, 2004 by USEPA, these restrictions are as follows:

- Prohibit the development and use of property for residential housing, elementary and secondary schools, childcare facilities and playgrounds.
- Prevent access to or use of groundwater until the Class GA Groundwater Standards are met.

These restrictions were developed based on the recorded findings for SEAD-27, SEAD-64A, and SEAD-66, but would apply to the entire PID parcel.

1.4.4 Regional Topography

SEDA lies on the western side of a series of north-to-south trending rock terraces that separate Cayuga Lake on the east and Seneca Lake on the west. The rock terraces range in elevation from 490 feet above Mean Sea level (MSL) in northern Seneca County to as much as 1,600 feet above MSL at the southern end of the lakes. Elevations on SEDA range from 450 feet (NGVD, 1929) on the western boundary to 760 feet (NGVD, 1929) in the southeast corner. The Depot's land surface generally slopes downward to the west and upward to the north.

1.4.5 Regional Climate

Table 1-3 summarizes climatological data for the SEDA area. The nearest source of climatological data is the Aurora Research Farm located approximately 10 miles east of SEDA, which provided precipitation and temperature measurements. Meteorological data collected from 1965 to 1974 at Hancock International Airport in Syracuse, New York, were used in preparation of the wind rose. The

airport is located approximately 60 miles northeast of SEDA, and is representative of wind patterns at SEDA. The wind rose is presented in **Figure 1-12**.

A cool climate exists at SEDA with temperatures ranging from an average of 23°F in January to 69°F in July. Marked temperature differences are found between daytime highs and nighttime lows during the summer and portions of the transitional seasons. Precipitation is well-distributed, averaging approximately 3 inches per month (**Figure 1-13**). This precipitation is derived principally from cyclonic storms which pass from the interior of the county through the St. Lawrence Valley. Seneca, Cayuga, and Ontario Lakes provide a significant amount of the winter precipitation and moderate the local climate. The annual average snowfall is approximately 100 inches. Wind velocities are moderate, but during the winter months there are numerous days with sufficient winds to cause blowing and drifting snow. The most frequently occurring wind directions are westerly and west-southwesterly.

As **Table 1-3** shows, temperature tends to be highest from June through September. Precipitation and relative humidity tend to be rather high throughout the year. The months with the greatest amount of sunshine are June through September. Mixing heights tend to be lowest in the summer and during the morning hours. Wind speeds also tend to be lower during the morning, which suggests that dispersion will often be reduced at those times, particularly during the summer. No episode-days are expected to occur with low mixing heights (less than 500 m) and light wind speeds (less than or equal to 2 m/s).

Daily precipitation data measured at the Aurora Research Farm in Aurora, New York for the period (1957-1991) were obtained from the Northeast Regional Climate Center at Cornell University. The maximum 24-hour precipitation measured at this station during this period was 3.91 inches on September 26, 1975. The reported mean annual pan evaporation was 35 inches, and annual lake evaporation was a reported 28 inches. An independent value of 27 inches for mean annual evaporation from open water surfaces was estimated from an isopleth presented in the Water Atlas of the United States (Water Information Center, 1973).

Information on the frequency of inversion episodes for a number of National Weather Service stations is summarized in the Mixing Heights, Wind Speeds, and Potential for Urban Air Pollution Throughout the Contiguous United States (George C. Holzworth, USEPA, 1972). The closest stations for which inversion information is available are in Albany, New York, and Buffalo, New York. The Buffalo station is nearer to SEDA but almost certainly exhibits influences from Lake Erie. These influences would not be expected to be as noticeable at SEDA.

SEDA is located in the Genesee-Finger Lakes Air Quality Control Region (AQCR). The AQCR is designated as non-attainment for ozone and attainment or unclassified for all other criteria pollutants. Data for the existing air quality in the area which surrounds the SEDA, cannot be obtained since the nearest state air quality stations (Rochester of Monroe County or Syracuse of Onondaga County) are 40 to 50 miles away from the Depot and are not representative of the conditions at SEDA. A review of the data for Rochester, which is in the same AQCR as the SEDA, indicates that all monitored pollutants (sulfur dioxide, particulates, carbon monoxide, lead, and ozone) are below state and federal limits, with

the exception of ozone. In 1987, the maximum ozone concentration observed in Rochester was 0.127 ppm; however, this value is not representative of the SEDA area which is a more rural environment.

1.5 OFF-SITE WELL INVENTORY

This section identifies private drinking water wells near SEAD-59 and SEAD-71. Knowledge of off-site wells is required when assessing any potential threats to drinking water supplies from releases at the site being investigated. Two private homes with private drinking water wells were identified within a one-mile radius of both SEAD-59 and SEAD-71 (**Figure 1-14**). The wells are located on Yerkes Road east of Route 96. These are the only domestic wells within one mile of the sites, and there are no public water supply wells within a one mile radius of the sites.

2.0 SUMMARY OF PREVIOUS INVESTIGATIONS

This section summarizes previous investigations conducted at SEAD-59 and SEAD-71. These previous investigations, listed below, have been presented in the previous reports.

- The Expanded Site Investigation conducted in 1994 (Parsons, 1995,1996)
- The Phase I Remedial Investigation conducted in 1997 (Parsons, 2002a)
- The time-critical removal action conducted in 2002 (ENSR, 2002a)

2.1 APPLICABLE OR RELEVANT AND APPROPRIATE REQUIREMENTS (ARARs)

The work completed at SEAD-59 and SEAD-71 falls under the jurisdiction of both the State of New York regulations (administered by NYSDEC) and Federal regulations (administered by the USEPA Region 2). Applicable or Relevant and Appropriate Requirements are promulgated regulatory standards or requirements and as such are legally enforceable and generally applicable to the media or conditions at the sites. In addition to ARARs, advisories, criteria, or guidance may be evaluated as "To Be Considered" (TBC) regulatory items. The Comprehensive Environmental Response Compensation and Liability Action indicates that the TBC category could include advisories, criteria, or guidance that were developed by USEPA, other federal agencies, or states that may be useful in developing CERCLA remedies. These advisories, criteria, or guidance are not promulgated and, therefore, are not legally enforceable standards such as ARARs.

Below lists the ARARs and TBCs that have been identified for SEAD-59 and 71.

Soils

- NYSDEC Technical and Administrative Guidance Memorandum (TAGM) HWR-94-4046 (January 1994) - TBC.

Groundwater

- NYSDEC Technical Operating Guidance Series (TOGS), 1.1.1, Class GA Groundwater Standards (June 1998 with updates) – ARAR
- Drinking Water Maximum Contaminant Level (MCLs) by the National Primary Drinking Water Regulations (USEPA, 2002d) – ARAR
- NYSDEC Technical Operating Guidance Series, 1.1.1, Class GA Groundwater Guidance Values (June 1998 with updates) - TBC
- USEPA Secondary Drinking Water Regulations (Code of Federal Register, Title 40, Chapter 1, Part 143) – TBC

For soil, The NYSDEC published criteria from TAGM-4046 were considered TBCs. Groundwater at SEAD-59/71 is not currently used as drinking water sources and is unlikely to be used as drinking water sources in the future. As a conservative approach, the NYSDEC Class GA Groundwater Standards (June 1998 with updates) and the Drinking Water MCLs were identified as ARARs for groundwater at SEAD-59/71. The NYSDEC Class GA Groundwater Guidance Values (June 1998 with updates) and the USEPA Secondary Drinking Water Regulations were identified as TBCs for groundwater at SEAD-59/71.

Soil and groundwater results at SEAD-59/71 were compared with the above identified ARARs and TBCs and the results are summarized in the following sections.

2.2 EXPANDED SITE INVESTIGATION

This section presents the summary of the ESI investigation activities and the investigation results. The ESI and results have been presented in the reports prepared by Parsons (1995, 1996).

2.2.1 ESI Activity Summary

The ESI was conducted in 1994. The following field investigations were performed during the ESI at SEAD-59 and SEAD-71:

SEAD-59

- Geophysical Investigations (seismic, EM-31, and ground penetrating radar (GPR) surveys) over approximately 3 acres of the site;
- Soil investigations including five soil borings and five test pits;
- Soil sampling consisting of six surface soil samples, 11 subsurface soil samples; and seven test pit soil samples;.
- Groundwater monitoring: installed three monitoring wells (MW59-1, MW59-2, and MW59-3) and collected four groundwater samples.

SEAD-71

- Geophysical Investigations (seismic, EM-31, and GPR surveys) over approximately 1.2 acres of the site;
- Soil investigation of two test pits;
- Soil sampling consisting of eight test pit soil samples;
- Groundwater monitoring: installed three monitoring wells (MW71-1, MW71-2, MW71-3) and collected two groundwater samples (MW71-2 was dry and therefore no groundwater sample was collected).

Samples collected from SEAD-59 and SEAD-71 were analyzed for Target Compound List (TCL) Volatile Organic Compounds (VOCs), Semi-volatile Organic Compounds (SVOCs),

Pesticides/Polychlorinated Biphenyls (PCBs), Target Analyte List (TAL) Metals, and cyanide in accordance with the New York State Department of Environmental Conservation Contract Laboratory Program (CLP) Statement of Work (SOW). Samples were also analyzed for Total Petroleum Hydrocarbon (TPH) by Method 418.1.

2.2.2 Summary of ESI Results

This section presents a summary of the ESI results for SEAD-59 and SEAD-71, respectively.

2.2.2.1 Summary of SEAD-59 ESI Results

The ESI conducted at SEAD-59 identified several areas that had been impacted by releases of VOCs, SVOCs, TPH, and to a lesser extent, heavy metals.

Several localized anomalies were observed during the EM-31 survey; however, no clearly defined boundaries of the large fill area in the northeastern portion of the EM grid could be determined.

In the large fill area located in the northeastern portion of SEAD-59, polycyclic aromatic hydrocarbons (PAH) compounds were found in 5 surface soil and 7 subsurface soil samples at concentrations that exceeded their respective TAGMs by at least an order of magnitude. Four inorganic elements were found at concentrations that exceeded their respective TAGMs by an order of magnitude in at least one soil sample. In addition, several underground 55-gallon drums (the contents of which were unknown) were observed at the TP59-3 test pit location. Stained soil was found at the TP59-4 test pit location and the source of the stained soil was not identified during the ESI. TPH was detected in all but two of the 20 soil samples collected from SEAD-59 and the concentrations ranged from 40 to 7,870 mg/kg, **Figure 2-1** shows the total reported BTEX concentrations found in the soil samples collected at SEAD-59. At a location approximately 100 feet south of the fill area, a disposal pit containing filled 2-gallon paint cans was found. BTEX constituents were detected at concentrations that exceeded their TAGMs by at least an order of magnitude in the sample collected at this location. These concentrations were presumably associated with the paint-stained soil.

The analytical results of the groundwater analyses in **Appendix A-12** indicated that groundwater at SEAD-59 has been moderately impacted by TPH. TPH was detected in two downgradient groundwater wells MW59-1 and MW59-2 at 2.6 mg/L and 1.38 mg/L, respectively (Parsons, 1995). TPH was not detected in the upgradient groundwater sample. Iron and sodium were detected at elevated concentrations (i.e., relative to the NYSDEC GA Standards) in both the upgradient and downgradient groundwater samples. The maximum iron and sodium concentrations were found in the upgradient groundwater sample. Manganese was found in one of the downgradient groundwater samples at a concentration that exceeded the Secondary Drinking Water Regulation by less than a factor of three.

The results of the ESI identified significant releases of BTEX and PAH compounds in materials comprising the fill and disposal pits at SEAD-59. In addition, trace quantities of TPH that were found in the fill materials were presumably leached into the groundwater beneath the site. These results suggested that the media at SEAD-59 had been impacted. Therefore, it was recommended that a Remedial Investigation/Feasibility Study (RI/FS) be initiated to fully delineate the extent of contamination in the media at SEAD-59.

Detailed results from the ESI can be found in the Expanded Site Inspection – Eight Moderately Low Priority AOC’s SEADs 5, 9, 12 (A and B), 43, 56, 69, 44 (A and B), 50, 58, and 59, (Parsons, 1995).

2.2.2.2 Summary of SEAD-71 ESI Results

The ESI conducted at SEAD-71 did not uncover any burial pits for paint or solvents, though it did indicate the soils at SEAD-71 had been impacted by historical activities on site.

The soils have been impacted by the waste materials that have been disposed in at least one disposal pit on site. Test pitting was performed at two locations (TP71-1 and TP71-2). TP71-1 was approximately 75 feet west of the Fenced Area and TP71-2 was within the Fenced Area. Eight soil samples were collected from the two test pits. At least one PAH was detected above the TAGM in all eight samples. Construction debris was also found at TP71-1 and was composed of chain link fencing, sheet metal, asphalt, and a crushed, yellow, 20-gallon drum. A 0.75-foot thick layer of fine angular black debris (resembling creosote or soot in shale appearance) was observed immediately below the construction debris layer. Heavy metal concentrations above TAGM also were present in all of the samples, though no consistent pattern in their occurrences was evident.

No VOCs, SVOCs, pesticides, or PCBs were detected in SEAD-71 groundwater during the ESI. With the exception of aluminum, iron, manganese, and thallium, all metal concentrations detected during the ESI were below the ARARs and TBCs identified for the project.

The ESI results indicated that the surface soil had been impacted by PAHs. Therefore, it was recommended that an RI/FS be initiated to fully delineate the extent of contamination in the media at SEAD-71.

Detailed results from the ESI can be found in the Expanded Site Inspection – Seven Low Priority AOC’s SEADs 60, 62, 63, 64 (A, B, C, and D), 67, 70, and 71 (Parsons, 1996).

2.3 PHASE I REMEDIAL INVESTIGATION

This section presents the summary of the Phase I RI investigation activities and the investigation results. The Phase I RI and results have been presented in the report prepared by Parsons (2002a).

2.3.1 Phase I Remedial Investigation Activity Summary

The Phase I RI was conducted in 1997. The following field investigations were performed during the Phase I RI at SEAD-59 and SEAD-71:

SEAD-59

- Soil gas survey consisting of 241 sampling points;
- Geophysical investigations (EM-31, EM-61 and GPR surveys) were expanded east and south from the ESI survey;
- Test pitting program consisting of 19 test pits and 41 soil samples;
- Soil boring investigation consisted of 13 soil borings and 68 soil samples;
- Groundwater monitoring well installation: reinstalled MW59-1 and MW59-2 and installed two new monitoring wells (MW59-4 and MW59-6). No groundwater samples were collected.

SEAD-71

- Geophysical investigations (EM-31, EM-61, and GPR surveys) were expanded west from the ESI survey;
- Test pitting program consisting of four test pits and 10 soil samples;
- Surface soil investigation consisting of 21 surface soil samples.

Samples collected from SEAD-59 and SEAD-71 were analyzed for TCL VOCs, SVOCs, Pesticides/PCBs, TAL Metals, and cyanide according to the NYSDEC CLP SOW. Samples were also analyzed for TPH by Method 418.

2.3.2 Summary of Phase I Remedial Investigation Results

This section presents a summary of the ESI results for SEAD-59 and SEAD-71, respectively.

2.3.2.1 Summary of SEAD-59 Phase I Remedial Investigation Results

One large area of elevated total VOC concentration was observed during the soil gas survey. This area encompasses most of SEAD-59, extending from north of the unnamed dirt road to the west of a 60,000-gallon oil storage tank, including the mounded fill area. The highest soil gas concentrations measured were within the boundaries of the fill area. Four smaller areas of elevated soil gas concentrations were detected in an area southeast of the fill area, an area directly southwest of the fill area, another area south of the fill area, and an additional area northwest of the fill area.

The Phase I RI performed at SEAD-59 expanded east and south from the ESI survey. The EM-61 survey performed detected 39 localized anomalies that could not be attributed to surface features and were presumed to be associated with unknown buried sources. Ground penetrating radar (GPR) data were also acquired during the Phase I RI over each distinct EM-61 anomaly to provide better

characterization of the suspected metallic sources. Test pit locations were selected based on the results of the EM-61, GPR, and soil gas anomalies. The excavated debris consisted of concrete, asphalt, metal, wood, chain link fencing, 55-gallon drums, and paint cans. A layer of petroleum hydrocarbon stained silt was observed in the 1.4 to 1.8 feet depth interval of test pit TP59-4. Soil sample TP59-4-1 was collected from this depth interval to verify the presence of contamination.

Figure 2-2 shows the sampling locations from the ESI and Phase I RI. The results of the Phase I RI soil investigation along with the soil sampling results from the ESI have identified significant releases of PAH compounds in the materials comprising the fill area, the area directly southwest of the fill area, the area south of the fill area, and the area southeast of the fill area at SEAD-59. Twelve PAH compounds exceeded their associated TAGM values. **Figure 2-3** shows the benzo(a)pyrene concentrations in soil and **Figure 2-4** shows the concentrations of total xylene in soils. SVOCs and metals were detected in quantities above their associated TAGMs at SEAD-59. Antimony, lead, mercury, silver, sodium, and zinc were reported at concentrations at least two times the associated TAGM values in soils. In addition, BTEX compounds were detected above their associated TAGMs in one area south of the fill area where paint cans were found during the test pit investigation. TPH was detected between 34.8 mg/kg and 19,700 mg/kg in 35 of the 55 soil samples collected during the ESI and Phase I RI.

Detailed results of the Phase I RI can be found in the Phase I Remedial Investigation (RI) at the Fill Area west of Building 135 (SEAD-59), and the Alleged Paint Disposal Area (SEAD-71), (Parsons, 2002a).

2.3.2.2 Summary of SEAD-71 Phase I Remedial Investigation Results

The Phase I RI performed at SEAD-71 expanded the investigation west from the ESI in 1994. **Figure 2-5** shows the test pit locations selected based on GPR data conducted during the Phase I RI. Debris found in the test pits consisted of black cinders, wood, asphalt bricks, stone slabs, fencing, piping and railroad ties. Surface soil samples were collected from 20 locations across the site and shown in **Figure 2-5**.

The data collected from the Phase I RI and the ESI did not uncover a burial pit for paint or solvents, though it indicated soils at SEAD-71 had been impacted by historical activities on site. Surface soils both within the Fenced Area and in the western portion of the site had PAHs and metals present above the TAGM values. A total of 22 SVOCs (all PAHs) were found in the surface soil and test pit soil samples collected at SEAD-71 during the Phase I RI. 15 PAH compounds were found at concentrations exceeding the associated TAGM values and at least one PAH exceedance was noted in each of the 20 surface soil samples and in one out of the ten soil samples collected from test pits in the Phase I RI. **Figure 2-6** shows benzo(a)pyrene concentrations in soil. Test pit samples also indicated that subsurface soils had been impacted. One test pit in the western area of the site (TP71-3) revealed that soils as deep as 11 feet below ground surface had been impacted, presented in **Appendix A**. Elevated TPH concentrations were detected in the sample collected from this depth

interval and test pit logs recorded a slight hydrocarbon odor. However, none of the other test pits revealed TPH impacts at this depth. Metals concentrations above the TAGM values were present in all of the surface soil samples and eight of the test pit soil samples. Lead, mercury, and zinc were detected at concentrations at least five times the associated TAGM values.

The Phase I RI results suggested that the surface soils within the Fenced Area had been impacted by the presence of PAHs, TPH, metals, and to a lesser extent, pesticides. Elevated carcinogenic PAH concentrations (i.e., above TAGM values) were observed for the majority of the surface soil samples within the Fenced Area. The benzo(a)pyrene toxicity equivalent (BTE) concentrations of seven samples (SS71-6, -11, -12, -13, -15, -16, and -17) within the Fenced Area were above 10 mg/kg, the cleanup goal for carcinogenic PAHs used at SEAD-11 (per NYSDEC comments on the Action Memorandum for SEAD-11 dated January 26, 2004). Several metals were detected above the TAGM values and a highest lead hit of 3470 mg/kg was observed in surface soil within the Fenced area. Several pesticides were detected but the detected concentrations were below the TAGM values for all analytes with the exception of endrin and heptachlor epoxide. The maximum endrin and heptachlor epoxide concentrations were 120 ug/kg and 180 ug/kg, respectively. TPH was detected in all surface soil samples within the Fenced Area with the exception of SS71-11. The maximum TPH concentration, 5220 mg/kg, was detected in surface soil at SS71-15.

Elevated TPH concentration (1800 mg/kg) was observed in subsurface soil (10.5 to 11 ft bgs.) at one test pit location, TP71-3, in the western portion of the site. The PAH concentrations were also elevated (i.e., above the TAGM values) at this location and depth.

Detailed results of the Phase I RI can be found in Phase I Remedial Investigation (RI) at the Fill Area west of Building 135 (SEAD-59), and the Alleged Paint Disposal Area (SEAD-71) (Parsons, 2002a).

2.4 TIME-CRITICAL REMOVAL ACTION

This section provides a general overview of the work performed by ENSR in 2002 during the TCRA.

2.4.1 Purpose of Time-Critical Removal Action

The ESI and Phase I investigations at SEAD-59 and SEAD-71 confirmed the presence of drums, paint cans, and other containers. The presence of such buried objects was of concern since the nature of the contents was unknown. The uncertainty of the contents of the buried items at the sites, the geophysical anomalies, and the contamination in soils and groundwater were considered justification for performing removal actions at SEAD-59 and SEAD-71. While removal of drums, paint cans, and other containers was the focus of the planned removal actions for both sites, the contamination present in the soils and groundwater that surrounded these items was also addressed by this action.

The TCRA was proposed in order to eliminate a potential threat to the surrounding populations. Documentation supporting this TCRA is found in the Decision Document – Time-Critical Removal Action, (Parsons, 2002c). The primary objective of the removal action was to remove drums and other

containers with unknown contents and to eliminate or significantly reduce the potential for human or environmental exposure to BTEX, TPH, PAH, and metal contamination in debris and contaminated soils. Following implementation of the removal action, ENSR collected confirmatory soil data to evaluate if unacceptable risk remains and if migration of pollutants requires further action.

2.4.2 Summary of Time-Critical Removal Action

The TCRA was conducted between September and November 2002 by ENSR. The tasks implemented during the TCRA were excavation and staging of impacted soils, separation of debris, sampling and analysis of excavated areas and stockpiled soils, installation of three additional groundwater monitoring wells (MW59-7, MW59-8, and MW71-4), and backfilling and grading of SEAD 59 and SEAD-71 with acceptable soil from the stockpiles.

Details of the work performed at SEAD-59 and SEAD-71 can be found in the Removal Report SEAD-59 and SEAD-71 Time-Critical Removal Action (ENSR, 2002). A summary of the activities implemented follows:

- 14,105 cubic yards (cy) of soil was excavated from seven areas (Area-1, 2, 3, 4, Others A, Others B, and Others C) at SEAD-59 as shown in **Figure 2-7**.
- 663 cy of soil was excavated from nine areas (Area-A, B, B2, C, D, D2, E1, E2, and E3) at SEAD-71 as shown in **Figure 2-8**.
- 7,360 cy of stockpiled soil from SEAD-59 and SEAD-71 was backfilled on the sites.
- 3,805 tons of stockpiled soil was sent off-site for disposal. 479 tons of this soil was stabilized with trisodium phosphate (TSP) at a ratio of 97% soil and 3% TSP.
- 46 tons of debris was sent off-site for disposal.
- An estimated 5,428 cy of soil remains in stockpiles at SEAD-59; SEAD-59 stockpile locations are shown in **Figure 2-7**.
- Additional groundwater monitoring wells were installed; two at SEAD-59 (MW59-7 and MW59-8) and one at SEAD-71 (MW71-4), as shown in **Figures 2-7** and **2-8**, respectively.

The debris most commonly encountered was construction and demolition debris comprised of bricks, concrete, asphalt, and scrap metals, pipe, lumber and wood. All large pieces of concrete that were clean were used as backfill in Area-1 (including Area-1A and Area-1B) at SEAD-59 (shown in **Figure 2-7**). The remaining construction and demolition debris was shipped off-site for disposal.

Drums and pails found in two areas at SEAD-59, as described below, were disposed off-site.

- Area-3 - dried and crushed paint pails from one quart to five gallon in size.

- Area-1 - 55-gallon drums, and pieces of drums and pails. Most of these were empty and had been previously crushed. Approximately nine drums had substantial amount of solid material in them. The analysis of samples collected from these containers found non-hazardous material and the containers were disposed of as non-hazardous debris.

2.4.3 Time-Critical Removal Action Sample Collection and Designation

Two distinct groups of soil samples were collected during the TCRA: confirmatory samples obtained from the floor and perimeter walls of the excavated areas and stockpile samples obtained from excavated soil staged on site in stockpiles. The discussion below presents the sampling approach for the confirmatory samples and stockpile samples collected in the TCRA.

Confirmatory soil samples were collected from each of the excavated areas. Soil samples were obtained from the perimeter walls of the excavation area and the floor (i.e. bottom) of the excavated area at a frequency of one sample per 200 linear feet.

Excavated soil was stockpiled on-site in various windrows based on the areas where it was excavated. Each windrow stockpile comprised of approximately 500 to 600 cy of excavated soil. For sampling purposes, each windrow was divided into 150-cy lots and stockpile samples were collected from these 150-cy lots.

Appendix K provides a copy of Table 1 from the Removal Report SEAD-59 and SEAD-71 Time-Critical Removal Action (ENSR, 2002a). This table presents a summary of the confirmatory and stockpile samples collected during the TCRA and lists the information such as sample ID, area removed from, selected analytical results, and final disposition. **Figure 2-9** and **Figure 2-10** shows TCRA confirmatory sampling locations at SEAD-59 and SEAD-71, respectively. It should be noted that confirmatory samples associated with soil that was later excavated based on the sample results were not shown in the figures. The confirmatory sample results are presented in this report in **Section 4**.

Confirmatory Samples

99 confirmatory soil samples from SEAD-59 and 42 confirmatory soil samples from SEAD-71 (both including field duplicates) were collected. It should be noted that soil associated with five of these confirmatory samples (CL-59-OTHERC-WE1, CL-71-B-WE1, CL-71-C-WW1, CL-71-D-WW1, and CL-71-D-WW2) later were excavated based on the confirmatory sample results.

The confirmatory samples (referred to as clearance samples in the ENSR report) were numbered as follows:

CL-XX-YY-ZZZ

CL – designates sample as clearance sample from an excavated area.

XX – refers to the SEAD number the sample was obtained from (i.e. 59 or 71).

YY – a one- or two-character alphanumeric designating the area number within the SEAD.

ZZZ – a three-character alphanumeric designating if it a perimeter or floor sample, and the number of the sample:

- F## – refers to floor sample and the appropriate sample number
- WN# - refers to perimeter sample from the north wall of the excavated area
- WE# - refers to perimeter sample from the east wall of the excavated area
- WS# - refers to perimeter sample from the south wall of the excavated area
- WW# - refers to perimeter sample from the west wall of the excavated area

Three excavation areas in SEAD-59 did not use the YY designation for the area as these three areas were labeled “OtherA”, “OtherB”, and “OtherC”. Details of the sample identification system can be found in the Final Field Sampling Plan SEAD-59 and 71 Time Critical Removal Action, (ENSR, 2002b):

Stockpile Samples

A total of 169 stockpile samples (including seven field duplicates) were collected during the 2002 TCRA. Stockpile samples (referred to as windrow samples in the ENSR report) were numbered as follows:

WS-XX-YY-ZZZ-A

WS – designates sample as windrow sample from excavated soil.

XX – refers to the SEAD number sample was obtained from (i.e. 59 or 71).

YY – a one- or two-character alphanumeric designating the area number within the SEAD.

ZZZ – a three digit windrow number of the pile sample was collected from.

A – the number of the 150-cy section of the windrow from which the sample was obtained.

Details of the sample identification system can be found in the Final Field Sampling Plan SEAD-59 and 71 Time Critical Removal Action, (ENSR, 2002b).

Both confirmatory and stockpile samples were analyzed for the following parameters:

- Volatile organic compounds by USEPA Method 8260B;
- Semivolatile organic compounds by USEPA Method 8270C;
- TAL Metals by USEPA Method 6010B;
- Cyanide by USEPA Method 9012A;
- Pesticides by USEPA Method 80801A;
- Polychlorinated Biphenyls by USEPA Method 8082;
- pH by USEPA Method 150.1;

- Total Dissolved Solids (TDS) by USEPA Method 160.1;
- Total Suspended Solids (TSS) by USEPA Method 160.2;
- Five-Day Biologic Oxygen Demand (BOD-5) by USEPA Method 405.1;
- Ammonia as nitrogen by USEPA Method 350.1/350.2

The TCRA data are evaluated, along with other site data, to characterize the current site conditions and the results are presented in **Sections 3 and 4**.

2.4.4 Additional Groundwater Monitoring Well Installation

In November, 2002, ENSR installed two additional groundwater monitoring wells at SEAD-59 (MW59-7 and MW59-8) and one additional groundwater monitoring well at SEAD-71 (MW71-4). **Figure 2-9** shows the additional groundwater monitoring wells installed at SEAD-59. **Figure 2-10** shows the additional groundwater monitoring well installed at SEAD-71. Details on the well installation and development can be found in the Removal Report SEAD-59 and SEAD-71 Time-Critical Removal Action (ENSR, 2002a) and in Appendix E of the Work Plan SEAD-59 and -71 Time Critical Removal Action (ENSR, 2002b).

The groundwater monitoring wells were sampled by Parsons in 2004 and the results are summarized in **Sections 3 and 4**.

3.0 POST-TCRA INVESTIGATIONS AND DATA EVALUATION

This section summarizes the work performed after the 2002 time-critical removal action. The work performed includes validating the data generated from the TCRA, developing a list of samples representing the current site conditions at SEAD-59 and SEAD-71, and conducting groundwater monitoring (collecting and analyzing groundwater samples and validating groundwater results). The work presented in this section has not been presented in any reports.

This section is organized as follows: **Section 3.1** presents the data validation conducted for the TCRA data; **Section 3.2** describes the process for identifying samples representing the current site conditions, and **Section 3.3** summarizes the groundwater monitoring performed in 2004.

3.1 TCRA DATA VALIDATION

This section addresses the TCRA data validation protocol (**Section 3.1.1**), the overall results of the data validation and qualifiers based on the data validation (**Section 3.1.2**), and the overall data validation results - precision, accuracy, and representativeness (**Section 3.1.3** through **Section 3.1.5**).

3.1.1 TCRA Data Validation Protocol

The acceptability of the data collected during the TCRA conducted in 2002 was evaluated since it was not included as part of the TCRA Report (ENSR, 2002a). The analytical data from the TCRA were validated by qualified Parsons chemists under the guidelines set forth in the Contract Laboratory Program National Functional Guidelines for Inorganic Data Review (USEPA, 2004b), Contract Laboratory Program National Functional Guidelines for Organic Data Review (USEPA, 1999a), Region 2 Resource Conservation and Recovery Act and Comprehensive Environmental Responsibility, Compensation, and Liability Act Data Validation Standard Operating Procedures (SOPs), NYSDEC Contract Laboratory Program Analytical Services Protocol (ASP), and United States Army Corps of Engineers (USACE) Shell for Analytical Chemistry Requirements (EM200-1-3), with consideration for the methodology requirements and the site-specific Quality Assurance Project Plan (QAPP) such as the Final Work Plan for SEAD-59 and 71 TCRA by ENSR (2002b).

The data validation included performance of a completeness audit and a review of the following parameters, where applicable: holding times, sample preservations, percentage of solids, quality control (QC) results of equipment/rinsate blanks, trip blanks, method blanks, matrix spike (MS) /matrix spike duplicate (MSD) analyses, laboratory control sample performances, laboratory and field duplicates, surrogate recoveries, instrument performance and calibration, chromatograms and mass spectrums, internal standard recovery, reporting limits, Inductively Coupled Plasma (ICP) serial dilution, interference check sample results, and ICP linear range. In performing the data validation, the raw data were spot-checked in accordance with the Region 2 SOP to evaluate whether there was any transcription error.

3.1.2 Overall Summary of Data Usability and Qualifiers

The TCRA data reviewed were determined to be usable except that the data presented in **Table 3-1** were rejected based on the review. The data were rejected as the internal standard areas for specified internal standards were below 25% of the corresponding 12-hr standard areas. All the other data were determined to be usable.

Qualifiers were attached to data by laboratories conducting analyses and by data validation personnel. These qualifiers often pertain to Quality Assurance/Quality Control (QA/QC) problems and may indicate questions concerning chemical identity, chemical concentration, or both. The qualifiers used are as follows:

For organics:

- U The analyte was analyzed for, but was not detected above the reported sample quantitation limit.
- J The analyte was positively identified; the associated numerical value is the approximate concentration of the analyte in the sample.
- N The analysis indicates the presence of an analyte for which there is presumptive evidence to make a "tentative identification."
- NJ The analysis indicates the presence of an analyte that has been "tentatively identified" and the associated numerical value represents its approximate concentration.
- UJ The analyte was not detected above the reported sample quantitation limit. However, the reported quantitation limit is approximate and may or may not represent the actual limit of quantitation necessary to accurately and precisely measure the analyte in the sample.
- R The sample results are rejected due to serious deficiencies in the ability to analyze the sample and meet quality control criteria. The presence or absence of the analyte cannot be verified.

For inorganics:

- J The associated value is an estimated quantity.
- U The material was analyzed for, but was not detected above the level of the associated value. The associated value is either the sample quantitation limit or the sample detection limit.
- UJ The material was analyzed for, but was not detected. The associated value is an estimate and may be inaccurate or imprecise.
- R The data was unusable. (Note: Analyte may or may not be present.)

All data were considered acceptable and included in the evaluation except that analytical data with an "R" (rejected) qualifier (i.e., those presented in **Table 3-1**) were not retained for use in the evaluation.

3.1.3 Precision

The term precision is used to describe the reproducibility of results. It can be defined as the agreement between the numerical values of two or more measurements resulting from the same process. In the case of chemical analyses, precision is determined through the analyses of duplicate environmental samples. Duplicate sample analyses include matrix spike duplicate analysis, laboratory control spike duplicate analysis, field duplicate analysis, and replicate instrumental analyses of individual environmental samples. A total of 15 field duplicate samples were available for the soil samples collected during the TCRA.

Precision estimates were obtained using the relative percent difference (RPD) between duplicate analyses. Overall the RPDs of the TCRA dataset were found to be acceptable (i.e. within the USEPA Region 2 limits, the USACE limits, and the limits presented in the QAPP) with the following exceptions: 1) some metals in several samples and their field duplicates; 2) certain volatile organic compounds, semivolatile organic compounds, and pesticides in several MS/MSD pairs; 3) hexachlorocyclopentadiene in one laboratory control sample and duplicate (LCS/LCSD) pair. The associated results were qualified in accordance with the USEPA Region 2 SOP. No data were deemed unacceptable based on the precision evaluation.

3.1.4 Accuracy

Accuracy is a measure of the closeness of a reported concentration to the true value. Accuracy is usually expressed as a bias (high or low) and is determined by calculating percent recovery (%R) from spiked samples. During field sampling and sample shipping, contamination that could affect the accuracy of analysis results may be introduced into the samples. Field blanks were used during sample collection and shipment to detect field contamination. Contamination affecting accuracy can also be introduced during laboratory analysis. Method blanks were used during laboratory procedures to assess laboratory-introduced contamination.

Estimates of accuracy are more difficult to obtain than precision since accuracy requires knowledge of the true value. In the case of chemical analyses, accuracy is determined through the introduction of compounds or elements to samples of known concentrations, or analytical spikes. The assumption is that compounds will be recovered from environmental samples to the same degree as in analytical spikes.

Two types of compounds were added to environmental samples for assessing accuracy: surrogate compounds and matrix spike compounds. Surrogates are compounds that closely approximate target analytes in structure, but are not target analytes. Surrogate compounds generally are added to samples in the preparation stages and monitor the effectiveness of the preparation process. Matrix spike compounds are target analytes that are added based upon expectations of matrix interferences that impede analyte detection. Laboratory method blank samples were spiked with surrogate

compounds, per analysis day, as an additional means of estimating accuracy. The accuracy of chemical analyses was estimated using the percent recovery of compounds or elements that were added to analytical spikes.

MS/MSD recoveries for the TCRA datasets were found to be acceptable (i.e. within the USEPA Region 2 limits, the USACE limits, and the limits presented in the QAPP) except that the recoveries of certain VOC, SVOC, pesticide, and inorganic fractions from some MS/MSD samples were outside the limits. The associated results were qualified in accordance with the USEPA Region 2 SOP. No data were deemed unacceptable based on the MS/MSD evaluation.

LCS/LCSD recoveries for the TCRA datasets were found to be acceptable (i.e. within the USEPA Region 2 limits, the USACE limits, and the limits presented in the QAPP) except that the recoveries of certain VOC and SVOC fractions from some LCS/LCSD samples were outside the limits. The associated results were qualified in accordance with the USEPA Region 2 SOP. No data were deemed unacceptable based on the LCS/LCSD evaluation.

Surrogate recoveries for the TCRA datasets were found to be acceptable (i.e. within the USEPA Region 2 limits, the USACE limits, and the limits presented in the QAPP) except that the recoveries of certain VOC, SVOC, pesticide, and PCB fractions from some samples were outside the limits. The associated results were qualified in accordance with the USEPA Region 2 SOP. No data were deemed unacceptable based on the surrogate recovery evaluation.

Acetone, methylene chloride, tetrachloroethene, 1,1,1-trichloro-1,2,2-trifluoroethane, di-n-butylphthalate, and bis(2-ethylhexyl)phthalate were detected in one or more method blank samples and di-n-butylphthalate and iron were detected in one or more rinsate blank samples. The associated results were qualified in accordance with the USEPA Region 2 SOP. No data were deemed unacceptable based on the method blank or field blank results.

3.1.5 Representativeness

Representativeness expresses the extent to which collected data define site contamination. Factors influencing representativeness include sample collection, selection of sampling locations representative of site conditions, and use of appropriate chemical methods for sample analyses. Sampling from locations representative of site conditions was achieved through implementation of the field sampling plan (ENSR, 2002b).

Field duplicates were collected and analyzed in order to assess the influence of sample collection on representativeness. Field duplicates were collected for approximately 6 percent of field samples.

During the data validation, representativeness has been evaluated by:

- Sample Package Completeness and Deliverables
- Technical Holding Time

- QA/QC Results

3.1.5.1 Sample Package Completeness and Deliverables

In general, the data packages submitted by Mitkem Corporation (MITKEM) and Columbia Analytical Services (CAS) are sufficient for the data validation. Some information was missing from the laboratory reports such as DDT/endrin breakdown information for pesticide/PCB analyses conducted by MITKEM, surrogate recovery from the column where the lower value was reported for all pesticide and PCB analyses conducted by CAS, cleanup effectiveness information for PCB and pesticide analysis. However, the lack of the information is not expected to significantly impact the data quality based on the data review. Therefore, no data were rejected based on the completeness of the sample deliverables.

3.1.5.2 Sample Preservation and Technical Holding Time

All the samples were preserved according to the USEPA Region 2 preservation criteria and analyzed within the holding time with several exceptions, mainly due to elevated cooler temperature. The reason for the elevated temperature was that the temperature was taken within 2 hours from the last sample was collected. Samples were preserved with ice. Therefore, no action was taken based on the elevated cooler temperature. Solids percentage was greater than 50% for all samples evaluated.

3.1.5.3 Other QA/QC Results

Other QA/QC results were reviewed during the data validation such as instrument performance, reporting limits, instrument calibration, ICP serial dilution for inorganic analysis, ICP linear range for inorganic analysis, and ICP interference check. The data were qualified based on the Region 2 SOP.

3.1.5.4 Laboratory Difference

It should be noted that the soil data associated with the SEAD-59/71 TCRA were from the two different laboratories: MITKEM and CAS. Some differences of sample analyses were observed between the two laboratories during the data validation process. As an example, for pesticides and PCB analyses, the MITKEM reported the lower value from the two columns as the laboratory suspected interference while CAS reported the higher value of the values from the two columns.

Overall, based on the evaluation of package completeness, sample preservation, and other QA/QC data, the TCRA data were deemed acceptable and representative of the site condition.

3.1.6 Protocol for Using Duplicate Results

The analytical results of each duplicate pair (field duplicate pair or laboratory duplicate pair) were averaged to produce a single result to represent the level at the sample location. The following procedures were used to average the results of a duplicate pair:

- If an analyte was detected in both the sample and the duplicate sample, then the detected values were averaged.
- If an analyte was not detected in either the sample or the duplicate sample, then the laboratory reporting limits (RLs) were averaged.
- If an analyte was detected in only one sample of a duplicate pair; then the analyte was considered present at a level equal to the average of the detected value and one-half of the reporting limit for the non-detect.

Table A-1A in **Appendix A** presents the method used for selecting qualifiers for the duplicate pair average result. The sample and its duplicate were treated as one entry and the average concentration was used to represent the result at the sampling location. This protocol is reflected in all the summary statistics (i.e. number of detections or exceedances and the maximum concentration) presented in this report. **Tables A-1B/C/D** in **Appendix A** present the data for sample duplicate pairs and their corresponding average values. It should be noted that a maximum value can be generated from the average of a sample duplicate pair.

3.2 DETERMINATION OF DATASET USED TO EVALUATE CURRENT SEAD-59 AND SEAD-71 CONDITIONS

The first step in evaluating the current conditions of SEAD-59 and SEAD-71 is to determine which analytical samples represent the current site conditions. For groundwater, data collected during the 1994 ESI were deemed not representative of the current site conditions as low-flow groundwater collection methods were not adopted during the sample collection and therefore the results might be overstated due to the potentially elevated turbidity. The 2004 groundwater results (as discussed in **Section 3.3**) will be used to represent the current site conditions. As a result, this section focuses on evaluation of soil data at SEAD-59/71.

All soil data collected during the TCRA and all historical samples collected during the ESI and Phase I RI were evaluated in this section to find the data representing the current site conditions. The data that represent the current site conditions include: (i) data collected during the TCRA that are associated with soil still at the sites; (ii) historical samples collected during the ESI and Phase I RI that were determined to be from locations still present at the sites (i.e. were not excavated). Three datasets were identified to be representative of the current conditions at SEAD-59/71 after the TCRA: (1) SEAD-59 soil data; (2) SEAD-59 Stockpile soil; and (3) SEAD-71 soil. This section explains how the representative datasets were selected.

3.2.1 Determination of the Use of Historical Samples

Historical samples were collected from soil borings, test pits, and surface soils during the ESI and the Phase I RI for SEAD-59 and SEAD-71. The location and elevation of historical samples was compared to information provided in the TCRA Removal Report (ENSR, 2002a) to determine which historical samples were from locations still present at the sites. **Table 3-2A** and **Table 3-2B** show the evaluation process to determine which historical samples were retained as part of the dataset representing current conditions and which historical samples were associated with soil excavated during the TCRA for SEAD-59 and SEAD-71, respectively.

The topography of the sites changed after the 2002 TCRA. The change of the topography resulted in a change of vertical depth of the soil samples collected within the excavation areas during the Expanded Site Inspection (Parsons, 1995, 1996) and Phase I RI (Parsons, 1997). The depth of these soil samples was re-designated based on the following information:

- Contour maps of each site before the TCRA (Parsons, 1995, 1996, 2002a),
- The “As-Built” contour map produced by ENSR (2002a), which shows the current contour of the sites,
- Original sample depth of top/bottom of the samples, when collected, and
- Estimated depth of TCRA excavation based upon volume removed and area of excavation, and field notes when available.

Depth for the ESI and Phase I samples collected outside of the excavation areas is not affected by the above evaluation and all samples collected outside the excavation areas were retained as samples representing the current site conditions.

Based on the re-designated depth of the ESI and Phase I samples, the soil data were categorized as surface (0-2 ft bgs.) and subsurface (2-15 ft bgs.). All confirmatory data, backfill data, and stockpile data from the TCRA were assumed as surface soil data. For cases where a clear-cut decision could not be made, a conservative approach was used (i.e., soil near 2 ft bgs. was designated as surface soil; similarly, soil near 15 ft bgs. was designated as subsurface soil). **Tables 3-3A, -3B, and -3C** list the samples included in the datasets for SEAD-59, SEAD-71, and SEAD-59 Stockpile, respectively.

3.2.2 SEAD-59 Dataset

For the SEAD-59 dataset, soil data collected from all historical site investigations/activities have been evaluated to determine whether or not the associated soils are representative of the Site’s current condition (i.e., not excavated during the TCRA). Soil data evaluated for SEAD-59 include:

- Soil data collected during the 1994 ESI by Parsons;
- Soil data collected during the 1997 Phase I RI by Parsons; and
- Confirmatory soil data and stockpile soil data collected during the 2002 TCRA.

Soil data collected during the ESI and Phase I RI were evaluated to decide whether the associated soil had been excavated during the 2002 TCRA. These samples were designated as existing or excavated based on the sample information (i.e., ground elevation, sample depth, and sample location), TCRA excavation information provided in the ENSR 2002 Final Draft Removal Report, and professional judgment. For cases where a clear-cut decision could not be made, the samples were assumed to be part of the existing dataset as a conservative (i.e., human health protective) approach. A detailed discussion of the evaluation is presented in **Section 3.2.1**.

All confirmatory samples collected during the 2002 TCRA activity and listed as confirmatory in Table 1 of the ENSR 2002 Final Draft Removal Report were included in the dataset, with the exception of CL-59-OTHERC-WE1. CL-59-OTHERC-WE1 was eliminated from the dataset based on notations made in the ENSR 2002 Final Draft Removal Report that additional excavation took place at these locations based on elevated levels over NYSDEC TAGM values. All TCRA stockpile samples marked as backfilled in Table 1 of the Final Draft Removal Report (ENSR 2002a) were included in the dataset.

In brief, only samples with associated soil still present at the site were retained in the dataset to represent the current site condition. **Table 3-3A** shows the samples included in the dataset to represent current SEAD-59 site condition. **Tables A-2A** and **A-2B** in **Appendix A** present the surface soil and subsurface soil results for the SEAD-59 dataset. **Figure 3-1** shows the locations of confirmatory samples and historical samples included in the SEAD-59 dataset.

3.2.3 SEAD-71 Dataset

The SEAD-71 dataset was established using the same approach used for SEAD-59. In summary, the following three groups of data were included in the SEAD-71 dataset:

- Soil data collected during the ESI and Phase I RI that are representative of site conditions after the 2002 TCRA,
- All confirmatory samples collected during the 2002 TCRA activity and listed in Table 1 of the ENSR (2002a) Final Draft Removal Report, with the exception of CL-71-B-WE1, CL-71-C-WW1, CL-71-D-WW1, and CL-71-D-WW2. These four confirmatory samples were eliminated from the dataset based on notations made in the ENSR (2002a) Final Draft Removal Report that additional excavation took place at these locations based on elevated levels over NYSDEC TAGM.

- All TCRA stockpile samples marked as backfilled in Table 1 of the ENSR (2002a) Final Draft Removal Report, plus WS-71-E1-009-3. WS-71-E1-009-3 was designated as stockpile in Table 1 of the ENSR report; however, the 10/31/02 note presented in the report indicated that the referenced stockpile was backfilled. Based on the fact that no excavated material was observed stockpiled at SEAD-71 and the 10/31/02 note, Sample WS-71-E1-009-3 was assumed backfilled and included in the SEAD-71 dataset.

Table 3-3B shows the samples included in the SEAD-71 dataset. **Table A-4A** and **Table A-4B** in **Appendix A** summarize the results for SEAD-71 surface soil and subsurface soil, respectively. **Figure 3-2** shows the locations of the confirmatory samples and historical samples included in the dataset for SEAD-71.

3.2.4 SEAD-59 Stockpile Data

Some of the stockpiles were used for backfill during the TCRA, some were disposed off-site, and the rest were staged in piles at SEAD-59. Stockpile samples associated with these stockpiles that remain at SEAD-59 are listed in **Table 3-3C**. These samples are categorized as “Stockpile” in Table 1 of the ENSR (2002a) Completion report, which is also presented in **Appendix K** of this report.

All stockpile samples listed as stockpile in Table 1 of the ENSR (2002a) report were included in the SEAD-59 stockpile dataset. As discussed earlier, WS-71-E1-009-3 was designated as stockpile in Table 1 of the ENSR (2002a) report; however, it was further determined backfilled. Therefore, WS-71-E1-009-3 was not included in the SEAD-59 stockpile dataset. **Table A-6** in **Appendix A** presents the results for the SEAD-59 stockpile dataset. **Figure 2-7** shows the locations of the stockpile staging areas.

3.3 GROUNDWATER INVESTIGATION

Groundwater samples were collected from the monitoring wells installed during the ESI, Phase I RI, and TCRA in 2004 from April 5 through April 6 (hereafter referred to as the April 2004 sampling event or April sampling event) and from August 30 through September 1 (hereafter referred to as the August 2004 sampling event or August sampling event). This section summarizes the groundwater investigation including sample collection, sample analysis, and data validation. The groundwater results are discussed in detail in **Section 4**.

3.3.1 Groundwater Sampling Procedures

Parsons conducted groundwater sampling after the TCRA during the April 2004 sampling event and the August 2004 sampling event. Groundwater samples were collected in accordance with the procedures specified in the USEPA Region 2 (1998) SOP titled Groundwater Sampling Procedure, Low Flow Purging and Sampling.

Prior to sampling the permanent wells, the static level of water present in the well was measured. Then, a bladder pump was installed in the well and the water level was measured again. Permanent wells were purged prior to sampling using the bladder pump constructed of stainless steel and containing a Teflon® bladder. The purging process began with the inlet of the pump being set at the bottom of the well screen and at least a few inches from the bottom of the well. It should be noted that the monitoring wells at SEAD-59/71 generally have low level of static water (e.g., most wells have static water less than 4 ft); therefore, the Region 2 specified rule of 2 ft from the bottom of the well generally can not be applied at the sites. Cautions should be taken when using these groundwater data as the groundwater results may be overstated by potentially elevated turbidity. A flow rate of between (0.03 and 0.6 L/min) was then established and the standing water contained in the well was purged and captured in a graduated five-gallon bucket. During the purging process, the water level in the well was continuously monitored with an electronic water level meter and the level was periodically recorded. Water quality indicator parameters including turbidity, temperature, specific conductivity, pH, dissolved oxygen content (DO), and oxidation-reduction potential (ORP) were monitored and recorded every two to four minutes using a Horiba U-22 Water Quality Meter with Flow Cell. Well purging and monitoring continued until the quality of the sampled groundwater indicated that the well had stabilized. The well was considered stabilized and ready for sample collection once the indicator parameter values remained within the criteria listed in **Table 3-4** for three consecutive readings. During all the sampling events, all criteria listed in **Table 3-4** were met before the sample collection with the exception of turbidity. Although a turbidity of less than 10 nephelometric turbidity units (NTUs) was preferable, the turbidity in most wells exceeded 10 NTUs during the 2004 sampling events. In addition, the three consecutive readings of turbidity reading was not within 10% for MW59-6 (both sampling events), MW59-7 (August sampling event), and MW71-1 (August sampling event).

Groundwater sampling commenced once the well had stabilized, or once the water level in the well had recovered sufficiently to permit collection of samples. In some very low-yielding formations, it was not possible to sample with minimal drawdown even using the lowest pumping rates.

Once the indicator parameters had stabilized, samples were collected at flow rates between 30 to 600 milliliters per minute to minimize the amount of water level drawdown found in the well (less than 0.3 ft with the water level stabilized). The water level was monitored every three to five minutes (or as appropriate) during pumping. Pumping rates were reduced as needed to the minimum capabilities of the pump to avoid pumping the well dry. If the well's recharge rate was very low, purging and sampling was interrupted to ensure that the well's static water level did not drop below the level of the pump. A steady purge/sample flow rate was maintained to the maximum extent practicable. Samples were collected by allowing the discharge flow from the sampling pump to flow slowly down the inside of the container.

Gauging, purging, sampling, and monitoring equipment were decontaminated by standard procedures listed in the USEPA Region 2 (1998) SOP prior to being used at each well. Water level indicators and pumps were placed into polyethylene bags to prevent contamination during storage or transit.

3.3.2 Groundwater Sample Analysis

At SEAD-59, the two groundwater sampling events collected 10 groundwater samples from wells MW59-1, -2, -3, -4, -6, -7, and -8. At SEAD-71, the two groundwater sampling events collected six groundwater samples from wells MW71-1, -2, -3, and -4. The results of the 2004 groundwater samples are presented in **Section 4** of this report.

Groundwater samples were analyzed according to the following methods:

- Volatile organic compounds by USEPA Method 524.2
- Target Compound List Semivolatile organic compounds by USEPA SW846 Method 8270C
- TCL Pesticides/PCBs according to NYSDEC CLP SOW
- Target Analyte List Metals by USEPA Method 6010B
- Oil and Grease by USEPA SW846 Method 9070
- Nitrate/Sulfate by USEPA Method 300.1
- Chemical Oxygen Demand by USEPA Method 410.4
- Biological Oxygen Demand by USEPA Method 405.1
- Hardness by USEPA Method 130.3
- Total Dissolved Solids by USEPA Method 160.1
- Total Organic Carbon by USEPA Method 415.1

It should be noted that due to the laboratory mistakes, some groundwater samples collected during the April event were not analyzed for VOCs. The affected monitoring wells were re-sampled on June 8, 2004 and the samples were submitted for VOC analysis using Method 524.2. These VOC results are presented in **Table A-3** to supplement the results for the April samples.

3.3.3 Groundwater Levels

Groundwater level was measured during both sampling events at SEAD-59 and SEAD-71. The results are provided in **Table 3-5**. Groundwater flow direction map based on these results is presented in **Figure 1-9A**.

3.3.4 Groundwater Data Validation

The groundwater data collected in 2004 were validated by qualified Parsons chemists under the guidelines set forth in the Contract Laboratory Program National Functional Guidelines for Inorganic

Data Review (USEPA, 2004b), Contract Laboratory Program National Functional Guidelines for Organic Data Review (USEPA, 1999a), Region 2 RCRA and CERCLA Data Validation Standard Operating Procedures, NYSDEC Contract Laboratory Program Analytical Services Protocol, and USACE Shell for Analytical Chemistry Requirements (EM200-1-3), with consideration for the methodology requirements and the site-specific quality assurance requirement.

The data validation included performance of a completeness audit and a review of the following parameters, where applicable: holding times, sample preservations, quality control results of equipment/rinsate blanks, trip blanks, method blanks, matrix spike/matrix spike duplicate analyses, laboratory control sample performances, laboratory and field duplicates, surrogate recoveries, instrument performance and calibration, chromatograms and mass spectrums, internal standard recovery, reporting limits, ICP serial dilution, interference check sample results, and ICP linear range. In performing the data validation, the raw data were spot-checked in accordance with the Region 2 SOP to evaluate whether there was any transcription error.

Overall, all the groundwater data collected in 2004 were determined to be usable except that the selenium results in several samples were rejected (R qualified) based on the Contract Required Detection Limit (CRDL) standard check results. CRDL standard check recoveries were below 50% during several runs for selenium analysis; therefore, the associated selenium results (selenium results for 592007, 592010, 592009, 712006, 592006, 712007 and its field duplicate) were rejected in accordance with the Region 2 SOPs.

Qualifiers pertaining to precision, accuracy, representativeness and other Quality Assurance/Quality Control issues were added to the data and the definition of the qualifiers is presented in **Section 3.1**.

4.0 NATURE AND EXTENT OF IMPACTS

This section presents the analytical results for soil and groundwater at SEAD-59 and SEAD-71. As discussed in **Section 3.2**, sample results associated with soil removed during the time-critical removal action were not used to evaluate current SEAD-59 and SEAD-71 conditions and therefore will not be discussed in this section.

This section is organized as follows. **Sections 4.1** presents Applicable or Relevant and Appropriate Requirements and To Be Considered criteria for the sites. **Section 4.2** discusses the SEAD-59 soil and groundwater results. **Section 4.3** summarizes the results of the stockpile soil that remains at SEAD-59. **Section 4.4** presents the SEAD-71 soil and groundwater results.

4.1 ARARS AND TBCS

ARARs and TBCs identified for soil and groundwater at SEAD-59 and SEAD-71 are presented in **Section 2.1**. Below lists the ARARs and TBCs that have been identified for SEAD-59 and SEAD-71.

Soils

- NYSDEC Technical and Administrative Guidance Memorandum HWR-94-4046 (January 1994) - TBC.

Groundwater

- NYSDEC Technical Operating Guidance, 1.1.1, Class GA Groundwater Standards (June 1998 with updates) – ARAR
- Drinking Water Maximum Contaminant Level by the National Primary Drinking Water Regulations - ARAR
- NYSDEC Technical Operating Guidance, 1.1.1, Class GA Groundwater Guidance Values (June 1998 with updates) - TBC
- USEPA Secondary Drinking Water Regulations (EPA 822-B-00-001, 2000) – TBC

In addition, carcinogenic polycyclic aromatic hydrocarbons (cPAHs) in soils were compared to a level of 10 mg/kg (in benzo(a)pyrene toxicity equivalence), the cleanup goal for carcinogenic PAHs used at SEAD-11 (per NYSDEC comments on the Action Memorandum for SEAD-11 dated January 26, 2004). It should be noted that the 10 mg/kg level of total BTE for carcinogenic PAHs is only used for screening purposes here. It is not identified as an ARAR or a TBC, nor is it used as a cleanup goal or to replace risk assessment.

There are seven PAHs that are considered as carcinogenic PAHs: benzo(a)anthracene, benzo(a)pyrene (BaP), benzo(b)fluoranthene, benzo(k)fluoranthene, chrysene, dibenzo(a,h)anthracene, and indeno(1,2,3-cd)pyrene. In performing the comparison, the benzo(a)pyrene toxicity equivalent

concentrations of cPAHs were calculated for each sample. The BTE was used as a screening tool to evaluate potential impacts of carcinogenic PAHs in soil. This toxicity equivalence is based on the relative toxicity of the cPAHs, as cited by USEPA Integrated Risk Information System (IRIS) Database. The BTE concentration is calculated by multiplying the concentration of the seven individual cPAHs in each sample by the following factors (based on IRIS):

Benzo(a)pyrene	1
Dibenzo(a,h)anthracene	1
Benzo(a)anthracene	0.1
Benzo(b)fluoranthene	0.1
Indeno(1,2,3-cd)pyrene	0.1
Benzo(k)fluoranthene	0.01
Chrysene	0.01

A higher multiplier represents a greater carcinogenic health risk. The BTE concentration for each cPAH was then summed up to get the cPAH BTE concentration for the sample.

4.2 SEAD-59: NATURE AND EXTENT OF IMPACTS

This section discusses the soil and groundwater results at SEAD-59. **Section 4.2.1** presents surface soil (0-2 ft bgs.) results. **Section 4.2.2** presents subsurface soil (2-15 ft bgs.) results and **Section 4.2.3** summarizes groundwater results.

4.2.1 Surface Soil

A total of 185 surface soil (0-2 ft bgs.) samples were collected from SEAD-59. The analytical results are provided in **Appendix A Table A-2A** and are summarized in **Table 4-1A**. The following subsections present the results for VOCs, SVOCs, pesticides and PCBs, and metals, respectively.

4.2.1.1 Volatile Organic Compounds

19 VOC analytes were detected in surface soil samples at SEAD-59 (**Table 4-1A**). The VOC concentrations were all below the TAGM values except that the acetone concentrations exceeded the TAGM value (200 µg/kg) in two surface soil samples (CL-59-01-WE3 at 220 NJ µg/kg and CL-59-01-WE4 at 550 NJ µg/kg). It should be noted that acetone is a common laboratory contaminant. There is no evidence that acetone is associated with any release at the site.

4.2.1.2 Semivolatile Organic Compounds

31 SVOC analytes were detected in surface soil samples at SEAD-59 (**Table 4-1A**) and eight SVOC analytes were detected above TAGMs in at least one soil sample. Below shows a summary of the soil results with TAGM exceedances.

Parameter	Units	Number of Analyses	Number of Detects	Maximum Detected Concentration	NYSDEC TAGM 4046	Number of Exceedances
4-Chloroaniline	µg/kg	185	2	1200	220	1
Benzo(a)anthracene	µg/kg	185	96	8900	224	72
Benzo(a)pyrene	µg/kg	185	97	8050	61	88
Benzo(b)fluoranthene	µg/kg	185	99	6800	1100	42
Benzo(k)fluoranthene	µg/kg	185	93	7350	1100	35
Chrysene	µg/kg	185	97	8900	400	65
Dibenz(a,h)anthracene	µg/kg	185	72	1665	14	71
Indeno(1,2,3-cd)pyrene	µg/kg	185	90	4950	3200	2

The cPAH BTE concentrations for all surface soil samples, calculated in accordance with the method specified in **Section 4.1**, were compared to the screening level of 10 mg/kg. **Appendix A Table A-7A** presents the BTE values for surface soil samples. The BTE concentrations for all surface soil samples were below 10 mg/kg except for two samples - WS-59-01-013-1 (10.2 mg/kg) and duplicate pair of CL-59-01-F01 and FD-71-CL-04 (10.6 mg/kg). The site average BTE concentration was 1.36 mg/kg in surface soils. The 95% UCL of the average for BTE in surface soil for the site was 2.21 mg/kg. The 95% UCL was calculated using the USEPA Software for Calculating Upper Confidence Limits (UCL) (ProUCL version 3.00.02).

4.2.1.3 Pesticides and PCBs

16 pesticide analytes and one PCB analyte (Aroclor-1260) were detected in SEAD-59 surface soil as shown in **Table 4-1A**. 4,4'-DDE and 4,4'-DDT concentrations exceeded the TAGM value of 2,100 µg/kg in one single sample, CL-59-01-WN2. The 4,4'-DDE and 4,4'-DDT concentrations detected in CL-59-01-WN2 were 2,600 µg/kg and 3,700 µg/kg, respectively.

4.2.1.4 Metals

23 metals were detected in SEAD-59 surface soil as shown in **Table 4-1A**. With the exception of aluminum, potassium, selenium, and vanadium, these metals were detected above the TAGMs and below is a summary of the TAGM exceedances.

Parameter	Units	Number of Analyses	Number of Detects	Maximum Detected Concentration	NYSDEC TAGM 4046	Maximum SEDA Background	Number of TAGM Exceedances
Antimony	mg/kg	185	104	424	5.9	6.55	5
Arsenic	mg/kg	185	185	32.2	8.2	21.5	7
Barium	mg/kg	185	185	304	300	159	1
Beryllium	mg/kg	185	183	2.6	1.1	1.4	2
Cadmium	mg/kg	185	153	3.2	2.3	2.9	2
Calcium	mg/kg	185	185	214000	121000	293000	1
Chromium	mg/kg	185	185	39.3	29.6	32.7	2
Cobalt	mg/kg	185	185	47.8	30	29.1	2
Copper	mg/kg	185	185	305	33	62.8	20
Iron	mg/kg	185	185	64000	36500	38600	1
Lead	mg/kg	185	185	164	24.8	266	80
Magnesium	mg/kg	185	185	30200	21500	29100	3
Manganese	mg/kg	185	185	1290	1060	2380	4
Mercury	mg/kg	185	174	0.95	0.1	0.13	40
Nickel	mg/kg	185	185	88.3	49	62.3	3
Silver	mg/kg	185	88	2.9	0.75	0.87	62
Sodium	mg/kg	185	180	4060	172	269	87
Thallium	mg/kg	185	51	1.8	0.7	1.2	23
Zinc	mg/kg	185	185	341	110	126	19

Seven metals (i.e., copper, lead, mercury, silver, sodium, thallium, and zinc) were detected at concentrations above the TAGMs in at least 19 samples.

Lead was detected at concentrations above the TAGM value (24.8 mg/kg) in 80 samples and the maximum concentration was 164 mg/kg. It should be noted that USEPA (1998a) recommends a 400 mg/kg screening level for lead in soil at residential properties. A proposed cleanup level for lead was 1250 mg/kg and derived in accordance with the publication titled Recommendations of the Technical Review Workgroup for Lead for an Interim Approach to Assessing Risks Associated with Adult Exposures to Lead in Soil (USEPA, 1996). Lead concentrations in surface soil at SEAD-59 were all below the screening level for lead in soil at residential properties and the screening level for lead in soil at industrial properties.

4.2.1.5 Total Petroleum Hydrocarbons

A total of 55 (surface and subsurface) samples were collected from SEAD-59 and analyzed for Total Petroleum Hydrocarbons (TPH). The analytical results for the samples are presented in **Appendix A-11A**.

4.2.2 Subsurface Soil

A total of 14 subsurface soil (2-15 ft bgs.) samples were collected from SEAD-59. The analytical results for SEAD-59 subsurface soil are provided in **Appendix A Table A-2B** and a summary of the results is presented in **Table 4-1B**. The following subsections present the results for VOCs, SVOCs, pesticides and PCBs, and metals, respectively.

4.2.2.1 Volatile Organic Compounds

Nine VOC analytes were detected in subsurface soil samples collected from SEAD-59. All VOC concentrations were below the associated TAGM values (**Table 4-1B**).

4.2.2.2 Semivolatile Organic Compounds

27 SVOC analytes were detected in subsurface soils at SEAD-59 (**Table 4-1B**). The following six SVOCs were detected above their associated TAGM values in at least one sample.

Parameter	Units	Number of Analyses	Number of Detects	Maximum Detected Concentration	NYSDEC TAGM 4046	Number of Exceedances
Benzo(a)anthracene	µg/kg	14	8	4200	224	4
Benzo(a)pyrene	µg/kg	14	8	4600	61	5
Benzo(b)fluoranthene	µg/kg	14	9	4400	1100	1
Benzo(k)fluoranthene	µg/kg	14	8	4900	1100	1
Chrysene	µg/kg	14	9	4400	400	2
Dibenz(a,h)anthracene	µg/kg	14	4	84	14	3

The cPAH BTE concentrations for all subsurface soil were below 10 mg/kg. The cPAH BTE results are presented in **Appendix A Table A-7B** for subsurface soil samples. The site-wide average BTE concentration in subsurface soil was 1.44 mg/kg. The 95% UCL of the mean for cPAH BTE in subsurface soils was 7.06 mg/kg.

4.2.2.3 Pesticides and PCBs

13 pesticides were detected in subsurface soils at SEAD-59 (**Table 4-1B**). All pesticide concentrations were below the associated TAGM values.

4.2.2.4 Metals

21 metals were detected in subsurface soils at SEAD-59 (**Table 4-1B**). Seven metals (as shown below) were detected with concentrations above the TAGM values in at least one surface soil sample.

Parameter	Units	Number of Analyses	Number of Detects	Maximum Detected Concentration	NYSDEC TAGM 4046	Maximum SEDA Background	Number of TAGM Exceedances
Calcium	mg/kg	14	14	123000	121000	293000	1
Lead	mg/kg	14	14	65.5	24.8	266	2
Magnesium	mg/kg	14	14	34400	21500	29100	1
Mercury	mg/kg	13	5	0.15	0.1	0.13	1
Potassium	mg/kg	14	14	2520	2380	3160	1
Sodium	mg/kg	14	14	1150	172	269	5
Zinc	mg/kg	14	14	133	110	126	2

4.2.3 SEAD-59 Groundwater

A total of 13 groundwater samples were collected during the ESI in 1994 and during the April and August sampling events of 2004. The analytical results for the SEAD-59 groundwater samples are provided in **Appendix A Table A-3**. The three ESI samples were collected prior to the implementation of low-flow groundwater sampling method and the results may not adequately represent site conditions. Ten samples were collected from the two sampling events in 2004. Five samples were collected from the April 2004 sampling event from MW59-1, MW59-2, MW59-3, MW59-4, and MW59-6. Five samples (including one field duplicate) were collected from the August 2004 sampling event from MW59-2, MW59-3 (a field duplicate pair), MW59-6, MW59-7, and MW59-8.

The 2004 groundwater results are summarized in **Table 4-2A** and **Table 4-2B** for the April 2004 sampling event and the August 2004 sampling event, respectively. Unless otherwise specified, this section presents the 2004 groundwater results (i.e., the results of the groundwater samples collected in April and August, 2004) as these results are representative of the current groundwater conditions at SEAD-59. The following subsections present the results for VOCs, SVOCs, pesticides and PCBs, and metals, respectively.

4.2.3.1 Volatile Organic Compounds

April 2004 Sampling Event

As shown in **Table 4-2A**, no VOCs were detected in SEAD-59 groundwater except that toluene was detected in one monitoring well MW59-3. The detected toluene concentration was below the laboratory reporting limit (0.27 J ug/L vs. 0.5 ug/L) and the NYSDEC GA Standard (0.27 J ug/L vs. 5 ug/L). It should be noted that toluene is a typical contaminant introduced during field collection activities.

August 2004 Sampling Event

As shown in **Table 4-2B**, no VOCs were detected in SEAD-59 groundwater except that 1,1,1-trichloroethane was detected in one monitoring well MW59-3. The detected 1,1,1-trichloroethane concentration was below the laboratory reporting limit (0.45 J $\mu\text{g/L}$ vs. 0.5 $\mu\text{g/L}$) and the NYSDEC GA Standard (0.45 J $\mu\text{g/L}$ vs. 5 $\mu\text{g/L}$).

4.2.3.2 Semivolatile Organic Compounds

April 2004 Sampling Event

No SVOCs were detected in any samples collected during the April 2004 sampling event at SEAD-59.

August 2004 Sampling Event

No SVOCs were detected in SEAD-59 groundwater except that di-n-butylphthalate was detected in MW59-7 (see **Table 4-2B**). Di-n-butylphthalate was detected at one out of five groundwater locations at a concentration below the laboratory reporting limit (2.3 J $\mu\text{g/L}$ vs. 10 $\mu\text{g/L}$) and the NY State Class GA Groundwater Standard (2.3 J $\mu\text{g/L}$ vs. 50 $\mu\text{g/L}$). It should be noted that di-n-butylphthalate is a common laboratory contaminant.

4.2.3.3 Pesticides and PCBs

April 2004 Sampling Event

No pesticides or PCBs were detected in SEAD-59 groundwater collected in April 2004 except that 4,4'-DDE was detected in MW59-1 and MW59-6 and 4,4'-DDT was detected in MW59-3 (**Table 4-2A** and **Table A-3**). 4,4'-DDE was detected at 0.008 J $\mu\text{g/L}$ in wells MW59-1 and MW59-6, but the concentration was below the laboratory reporting limits (approximately 0.039 $\mu\text{g/L}$) and the NYSDEC GA standard of 0.2 $\mu\text{g/L}$. 4,4'-DDT was detected in well MW59-3 at a concentration below the NYSDEC GA Standard (0.042 $\mu\text{g/L}$ vs. 0.2 $\mu\text{g/L}$) and slightly above the laboratory reporting limit (0.042 $\mu\text{g/L}$ vs. 0.0396 $\mu\text{g/L}$).

August 2004 Sampling Event

No pesticides or PCBs were detected in any of the SEAD-59 groundwater samples collected during the August 2004 sampling event.

4.2.3.4 Metals

April 2004 Sampling Event

16 metals were detected in SEAD-59 groundwater during the April 2004 sampling event (**Table 4-2A**). The following lists a summary of the comparison with the identified ARARs/TBCs for those metals with ARAR or TBC exceedances.

Parameter	Units	Number of Analyses	Number of Detects	Maximum Detected Concentration	Criteria Type	Criteria Level	Number of Exceedances
Aluminum	µg/L	5	4	3250	SEC	50	3
Antimony	µg/L	5	4	8.6	GA	3	4
Iron	µg/L	5	5	3680	GA	300	2
Manganese	µg/L	5	5	314	SEC	50	3
Sodium	µg/L	5	5	304000	GA	20000	5

SEC = USEPA Secondary Drinking Water Regulations, identified as TBCs

GA = NYSDEC Class GA Groundwater Standards, identified as ARARs

August 2004 Sampling Event

18 metals were detected in SEAD-59 groundwater during the August 2004 sampling event (**Table 4-2B**). The following lists a summary of the comparison with the identified ARARs/TBCs for those metals with ARAR or TBC exceedances.

Parameter	Units	Number of Analyses	Number of Detects	Maximum Detected Concentration	Criteria Type	Criteria Level	Number of Exceedances
Aluminum	µg/L	6	6	372	SEC	50	6
Iron	µg/L	6	6	666	GA	300	3
Manganese	µg/L	6	6	294	SEC	50	3
Sodium	µg/L	6	6	235000	GA	20000	6

SEC = USEPA Secondary Drinking Water Regulations, identified as TBCs

GA = NYSDEC Class GA Groundwater Standards, identified as ARARs

4.3 SEAD-59 STOCKPILE SOIL: NATURE AND EXTENT OF IMPACTS

A total of 53 soil samples were collected from the stockpiles that are currently remaining at SEAD-59. The results of the stockpile soil samples are provided in **Appendix A, Table A-6** and are summarized in **Table 4-3**.

4.3.1 Volatile Organic Compounds

Ten VOC analytes were detected in SEAD-59 stockpile samples (**Table 4-3**). Acetone was detected most frequently and was detected in 13 out of 53 samples. It should be noted that acetone is considered to be a common laboratory contaminant. Methyl ethyl ketone and ortho-xylene were detected in five soil samples and the remaining VOCs were detected in four or less samples. All the detected VOC concentrations were below the respective TAGM values.

4.3.2 Semivolatile Organic Compounds

22 SVOCs (including 16 PAHs) were detected in the SEAD-59 stockpile samples (**Table 4-3**). Seven cPAHs were detected at concentrations above the TAGM values in at least 19 samples (as summarized below) and the concentrations of the other SVOCs were all below the TAGM values.

Parameter	Units	Number of Analyses	Number of Detects	Maximum Detected Concentration	NYSDEC TAGM 4046	Number of Exceedances
Benzo(a)anthracene	µg/kg	53	53	14000	224	52
Benzo(a)pyrene	µg/kg	53	53	16000	61	53
Benzo(b)fluoranthene	µg/kg	53	53	11000	1100	46
Benzo(k)fluoranthene	µg/kg	53	53	13000	1100	46
Chrysene	µg/kg	53	53	13000	400	52
Dibenz(a,h)anthracene	µg/kg	53	52	2900	14	52
Indeno(1,2,3-cd)pyrene	µg/kg	53	53	8000	3200	19

Appendix A Table A-8 presents the cPAH BTE values for all stockpile soil samples and **Table 4-4** lists the samples with the total cPAH BTE values above 10 mg/kg. The total cPAH BTE concentrations were above 10 mg/kg for 15 stockpile samples and the maximum total cPAH BTE concentration was 22.36 mg/kg. The average cPAH BTE concentration for SEAD-59 stockpile soil was 8.1 mg/kg. The 95% UCL of the mean for cPAH BTE concentration was 11.21 mg/kg.

4.3.3 Pesticides and PCBs

Eight pesticides were detected in the SEAD-59 stockpile samples (**Table 4-3**). No PCBs were detected in any of the stockpile samples. All pesticide concentrations were below the associated TAGM values. The most frequently detected pesticides were 4,4'-DDD, 4,4'-DDE, and 4,4'-DDT. 4,4'-DDD, 4,4'-DDE, and 4,4'-DDT were detected in 33, 33, and 37 stockpile samples, respectively. The maximum detected concentrations of 4,4'-DDD, 4,4'-DDE, and 4,4'-DDT were 450 µg/kg, 230 µg/kg, and 520 µg/kg, respectively. The other 5 pesticides were detected in six or less samples.

4.3.4 Metals

23 metals were detected in the SEAD-59 stockpile samples (**Table 4-3**). 12 out of the 23 metals were detected above the TAGM values and the results are summarized in the table below.

Parameter	Units	Number of Analyses	Number of Detects	Maximum Detected Concentration	NYSDEC TAGM 4046	Maximum SEDA Background	Number of TAGM Exceedances
Antimony	mg/kg	53	11	43.9	5.9	6.55	3
Chromium	mg/kg	53	53	35	29.6	32.7	3
Copper	mg/kg	53	53	51.8	33	62.8	14
Lead	mg/kg	53	53	1440	24.8	266	51
Magnesium	mg/kg	53	53	26600	21500	29100	1
Manganese	mg/kg	53	53	1220	1060	2380	2
Mercury	mg/kg	53	53	0.52	0.1	0.13	9
Nickel	mg/kg	53	53	56.6	49	62.3	1
Silver	mg/kg	53	9	4.7	0.75	0.87	6
Sodium	mg/kg	53	53	525	172	269	23
Thallium	mg/kg	53	27	0.99	0.7	1.2	12
Zinc	mg/kg	53	53	185	110	126	6

Lead was detected at concentrations above the TAGM value (24.8 mg/kg) in 51 out of 53 samples. With the exception of the lead concentration for WS-59-01-016-10 (1,440 mg/kg), lead concentrations in all SEAD-59 stockpile soil samples were below the screening level for lead in soil at residential properties (i.e., 400 mg/kg) and the screening level for lead in soil at industrial properties (i.e., 1250 mg/kg).

4.4 SEAD-71: NATURE AND EXTENT OF IMPACTS

This section discusses the soil and groundwater results at SEAD-71. **Section 4.4.1** presents surface soil (0-2 ft bgs.) results. **Section 4.4.2** presents subsurface soil (2-15 ft bgs.) results and **Section 4.4.3** summarizes groundwater results.

4.4.1 Surface Soil

A total of 69 surface soil (0-2 ft bgs.) samples were collected from SEAD-71. The results are provided in **Appendix A Table A-4A** and are summarized in **Table 4-5A**. The following subsections present the results for VOCs, SVOCs, pesticides and PCBs, and metals, respectively.

4.4.1.1 Volatile Organic Compounds

14 VOC analytes were detected in SEAD-71 surface soil samples (**Table 4-5A**). None of the detected VOC concentrations exceeded their associated TAGM values.

4.4.1.2 Semivolatile Organic Compounds

24 SVOCs were detected in SEAD-71 surface soil samples (**Table 4-5A**), among which 16 were PAHs. Below is a list of the SVOCs with concentrations above their associated TAGM values.

Parameter	Units	Number of Analyses	Number of Detects	Maximum Detected Concentration	NYSDEC TAGM 4046	Number of Exceedances
Anthracene	µg/kg	69	41	100000	50000	3
Benzo(a)anthracene	µg/kg	69	53	150000	224	40
Benzo(a)pyrene	µg/kg	69	53	120000	61	47
Benzo(b)fluoranthene	µg/kg	69	54	88000	1100	23
Benzo(ghi)perylene	µg/kg	69	48	62000	50000	1
Benzo(k)fluoranthene	µg/kg	69	42	130000	1100	20
Chrysene	µg/kg	69	56	150000	400	37
Dibenz(a,h)anthracene	µg/kg	69	40	25000	14	40
Dibenzofuran	µg/kg	69	27	38000	6200	4
Fluoranthene	µg/kg	69	58	440000	50000	6
Fluorene	µg/kg	69	28	62000	50000	1
Indeno(1,2,3-cd)pyrene	µg/kg	69	48	65000	3200	11
Naphthalene	µg/kg	69	15	46000	13000	1
Phenanthrene	µg/kg	69	54	290000	50000	5
Pyrene	µg/kg	69	56	280000	50000	6

The maximum cPAH concentrations were detected in sample SS71-11, located within the Fenced Area between Buildings 114 and 127.

Appendix A Table A-9A presents the cPAH BTE values for all SEAD-71 surface soil samples. Nine samples had cPAH BTE concentrations exceeding 10 mg/kg. Two of the samples (CL-71-C-WS1 and CL-71-E2-WE1) were confirmatory samples collected during the TCRA (with cPAH BTE concentrations of 13.3 mg/kg and 13.2 mg/kg, respectively). The remaining seven samples (SS71-6, -11, -12, -13, -15, -16, and -17) were from historical samples collected during the Phase I RI or ESI, and were collected from 0-0.2 ft bgs within the Fenced Area. **Figure 4-1** shows sample locations where cPAH BTE concentrations exceeded the benchmark of 10 mg/kg. The Fenced Area is located between Buildings 114 and 127 and had been used as an equipment storage area. Field notes indicated that the Fenced Area was paved in some locations and covered with crushed stone in other locations. Elevated PAH concentrations detected in surface soil within the Fenced Area are likely caused by hard fill that was used to construct the area. At the time of construction, the Army

typically utilized hard fill consisting of oiled crushed stone to form a sturdy base for areas subjected to heavy vehicular traffic and storage operations. The oil was used to help in the compaction of the crushed stone and aided in dust suppression. The presence of asphalt is noted in the boring log of MW71-1 presented in the ESI report (Parsons, 1996) and field notes recorded while surface soil samples were collected within the Fenced Area. The crushed asphalt materials in the hard fill and the oil used in the construction of the storage area are likely the cause of the consistently elevated PAH concentrations throughout the Fenced Area.

The SEAD-71 site-wide average cPAH BTE concentration in surface soil was 11.64 mg/kg while the average BTE concentration in surface soil outside the Fenced Area was 1.64 mg/kg. The 95% UCL of the mean BTE concentration for the entire site of SEAD-71 was 37.01 mg/kg while the 95% UCL of the mean BTE concentration in surface soil outside the Fenced Area was 4.17 mg/kg.

Elevated PAH levels in the Fenced Area appear to be confined to the surface soils. The cPAH concentrations at 1 foot bgs from TP71-2 were generally one order of magnitude lower than the concentrations in samples collected 0.2 feet bgs within the Fenced Area. The cPAH concentrations from subsurface soil (i.e., 2-15 ft bgs.) at TP71-2 were approximately two orders of magnitude lower than the concentrations in samples collected 0.2 feet bgs.

4.4.1.3 Pesticides and PCBs

16 pesticides and one PCB were detected in surface soil collected from SEAD-71 (**Table 4-5A**). All pesticide and PCB concentrations were below the associated TAGM values with the exception of endrin and heptachlor epoxide. The results of endrin and heptachlor epoxide are summarized in the table below.

Parameter	Units	Number of Analyses	Number of Detects	Maximum Detected Concentration	NYSDEC TAGM 4046	Number of Exceedances
Endrin	µg/kg	69	10	120	100	1
Heptachlor epoxide	µg/kg	69	12	180	20	4

4.4.1.4 Metals

23 metals were detected in SEAD-71 surface soil samples (**Table 4-5A**). Results of the metals detected above their respective TAGMs are summarized in the table below.

Parameter	Units	Number of Analyses	Number of Detects	Maximum Detected Concentration	NYSDEC TAGM 4046	Maximum SEDA Background	Number of TAGM Exceedances
Antimony	mg/kg	69	34	19.3	5.9	6.55	5
Arsenic	mg/kg	69	69	14.6	8.2	21.5	5
Cadmium	mg/kg	69	46	12.1	2.3	2.9	4
Calcium	mg/kg	69	69	295000	121000	293000	11
Chromium	mg/kg	69	69	60.3	29.6	32.7	5
Copper	mg/kg	69	69	134	33	62.8	21
Iron	mg/kg	69	69	65100	36500	38600	2
Lead	mg/kg	69	69	3470	24.8	266	33
Magnesium	mg/kg	69	69	59300	21500	29100	6
Manganese	mg/kg	69	69	1330	1060	2380	1
Mercury	mg/kg	69	55	2.7	0.1	0.13	10
Nickel	mg/kg	69	69	110	49	62.3	2
Silver	mg/kg	69	27	2.2	0.75	0.87	15
Sodium	mg/kg	69	67	1040	172	269	19
Thallium	mg/kg	69	18	2.3	0.7	1.2	10
Zinc	mg/kg	69	68	3660	110	126	17

Lead was detected in all 69 samples and was detected above the TAGM value (24.8 mg/kg) in 33 samples. The maximum lead concentration 3,470 J mg/kg was detected at SS71-16 within the Fenced Area. **Figure 4-2** shows the lead concentrations in soil within the SEAD-71 Fenced Area. The elevated lead concentration at SS71-16 appears to be isolated. The elevated lead hit is the only sample that exceeded the screening level for industrial scenario (1250 mg/kg) at SEAD-59/71. The next highest concentration within the Fenced Area at SEAD-71 was 572 mg/kg at SS71-19. The average lead concentration within the Fenced Area was 350 mg/kg, which was lower than the USEPA (1998) recommended 400 mg/kg screening level for lead in soil at residential properties. The only subsurface samples within the Fenced Area were collected from one test pit, TP71-2. TP71-2-1 collected from 1 ft bgs had a lead concentration of 25.3 mg/kg; while lead concentrations were 15.3 mg/kg or less in samples TP71-2-2, -3, and -4, which were collected from 2 ft bgs, 2-3.3 ft bgs, and 2 ft bgs, respectively. Therefore, the lead hit is considered isolated and the average lead concentration within the Fenced Area is well within the acceptable range.

4.4.1.5 Total Petroleum Hydrocarbons

A total of 26 (surface and subsurface) samples were collect from SEAD-71 and analyzed for TPH. The analytical results for the samples are presented in **Appendix A-11B**.

4.4.2 Subsurface Soil

A total of eight subsurface soil samples were collected at SEAD-71 between 2 and 8 ft bgs. The SEAD-71 subsurface soil results are provided in **Appendix A Table A-4B** and are summarized in

Table 4-5B. The following subsections present the results for VOCs, SVOCs, pesticides and PCBs, and metals, respectively.

4.4.2.1 Volatile Organic Compounds

Five VOC analytes were detected in subsurface soil at SEAD-71 but all VOC concentrations were below the associated TAGM values (**Table 4-5B**).

4.4.2.2 Semivolatile Organic Compounds

20 SVOCs (mainly PAHs) were detected in subsurface soils at SEAD-71 (**Table 4-5B**). The results of the SVOCs with concentrations above the associated TAGM values are summarized in the table below.

Parameter	Units	Number of Analyses	Number of Detects	Maximum Detected Concentration	NYSDEC TAGM 4046	Number of Exceedances
Benzo(a)anthracene	µg/kg	8	7	37000	224	4
Benzo(a)pyrene	µg/kg	8	7	22000	61	5
Benzo(b)fluoranthene	µg/kg	8	7	26000	1100	1
Benzo(k)fluoranthene	µg/kg	8	7	15000	1100	1
Chrysene	µg/kg	8	7	36000	400	3
Dibenz(a,h)anthracene	µg/kg	8	5	9800	14	4
Dibenzofuran	µg/kg	8	2	11000	6200	1
Fluoranthene	µg/kg	8	7	88000	50000	1
Indeno(1,2,3-cd)pyrene	µg/kg	8	6	12000	3200	1
Naphthalene	µg/kg	8	3	17000	13000	1
Phenanthrene	µg/kg	8	6	66000	50000	1
Pyrene	µg/kg	8	7	63000	50000	1

The maximum detected concentrations for the SVOCs listed above were detected in the test pit TP71 at sample locations TP71-1 or TP71-3-2.

Appendix A Table A-9B presents the cPAH BTE values in subsurface soils. The subsurface data set consists of eight samples and the BTE values were all below 10 mg/kg with the exception of the BTE value for TP71-1-1. The BTE value for TP71-1-1 was 39.81 mg/kg, above 10 mg/kg. The site-wide average BTE concentration in subsurface soil at SEAD-71 was 5.39 mg/kg. The 95% UCL of the mean for BTE concentration was 24.88 mg/kg.

4.4.2.3 Pesticides and PCBs

17 pesticides were detected in subsurface soil at SEAD-71 and all pesticide concentrations were below the associated TAGM values (**Table 4-5B**). No PCBs were detected in subsurface soil at SEAD-71.

4.4.2.4 Metals

21 metals were detected in subsurface soil at SEAD-71 (**Table 4-5B**). The results of the metals with concentrations above the associated TAGM values are summarized in the table below.

Parameter	Units	Number of Analyses	Number of Detects	Maximum Detected Concentration	NYSDEC TAGM 4046	Maximum SEDA Background	Number of TAGM Exceedances
Calcium	mg/kg	8	8	134000	121000	293000	1
Lead	mg/kg	8	8	96.9	24.8	266	3
Potassium	mg/kg	8	8	2940	2380	3160	1

Lead was detected in all eight subsurface samples from SEAD-71. The maximum lead concentration was 96.9 mg/kg, below the USEPA screening levels for residential and industrial use scenarios (i.e., 400 mg/kg for residential scenario and 1250 mg/kg for industrial scenario).

4.4.3 SEAD-71 Groundwater

A total of eight groundwater samples were collected during the ESI in 1994 and the two sampling events in 2004. The SEAD-71 groundwater results are provided in **Appendix A Table A-5**. Two samples were collected from MW71-1 and MW71-3 in 1994. Six groundwater samples were collected from the two sampling events in 2004. Three samples (plus a field duplicate) were collected from MW71-1, MW71-3, and MW71-4 (a field duplicate pair) in April 2004. Three samples were collected from MW71-1, MW71-2, and MW71-4 on August, 31 or September 1, 2004.

The two ESI samples were collected prior to the implementation of low-flow groundwater sampling method and the results might not adequately represent site conditions. Therefore, the discussion presented in this section focuses on the 2004 sampling results as they are representative of the current groundwater conditions at SEAD-71. The 2004 groundwater results for SEAD-71 are summarized in **Table 4-6A** and **Table 4-6B** for the April 2004 sampling event and the August 2004 sampling event, respectively.

The following subsections present the results for VOCs, SVOCs, pesticides and PCBs, and metals, respectively.

4.4.3.1 Volatile Organic Compounds

April 2004 Sampling Event

No VOCs were detected in SEAD-71 groundwater during the April 2004 sampling event except that 1,1,1-trichloroethane was detected in well MW71-4 (**Table 4-6A**). The detected 1,1,1-trichloroethane concentration was below the NYSDEC GA Standard (3.1 µg/L vs. 5 µg/L).

August 2004 Sampling Event

No VOCs were detected in SEAD-71 groundwater during the August 2004 sampling event except that 1,1,1-trichloroethane was detected in well MW71-4 (**Table 4-6B**). The detected 1,1,1-trichloroethane concentration was below the NYSDEC GA Standard (2.5 µg/L vs. 5 µg/L).

4.4.3.2 Semivolatile Organic Compounds

April 2004 Sampling Event

No SVOCs were detected in SEAD-71 groundwater during the April 2004 sampling event except that bis(2-ethylhexyl)phthalate was detected in well MW71-3 (**Table 4-6A**). The detected bis(2-ethylhexyl)phthalate concentration was below the laboratory reporting limit (1.6 J µg/L vs. 10.1 µg/L) and the NYSDEC GA Standard (1.6 J µg/L vs. 5 µg/L).

August 2004 Sampling Event

No SVOCs were detected in SEAD-71 groundwater during the August 2004 sampling event except that 4-nitroaniline was detected in MW71-2 (**Table 4-6B**). The detected 4-nitroaniline concentration was below the laboratory reporting limit (8.7 J µg/L vs. 11.1 µg/L) while it was above the NYSDEC GA guidance value, an identified TBC value (8.7 J µg/L vs. 5 µg/L).

4.4.3.3 Pesticides and PCBs

April 2004 Sampling Event

No pesticides or PCBs were detected in SEAD-71 groundwater during the April 2004 sampling event with the exception of 4,4'-DDE, 4,4'-DDT, and endrin ketone (**Table 4-6A**). 4,4'-DDE was detected in MW71-3 and MW71-4 at a concentration of 0.006 µg/L, which was below the laboratory reporting limit (approximately 0.04 µg/L). 4,4'-DDT was detected in MW71-3 and MW71-4 at 0.043 µg/L and 0.04 J µg/L, respectively. Endrin ketone was detected in MW71-3 at a concentration below the laboratory reporting limit (0.008 J µg/L vs. 0.0385 µg/L). The detected 4,4'-DDE, 4,4'-DDT, and

endrin ketone concentrations were all below the NYSDEC GA Groundwater Standards or guidance values (i.e., 0.2 µg/L, 0.2 µg/L, and 5 µg/L, respectively).

August 2004 Sampling Event

As shown in **Table 4-6B**, no pesticides or PCBs were detected in SEAD-71 groundwater during the August 2004 sampling event except that 4,4'-DDT was detected in well MW71-4 close to the laboratory reporting limit (0.0437 µg/L vs. 0.0408 µg/L) and below the NYSDEC GA Standard (0.0437 µg/L vs. 0.2 µg/L).

4.4.3.4 Metals

April 2004 Sampling Event

18 metals were detected in SEAD-71 groundwater during the April 2004 sampling event (**Table 4-6A**). Below lists the metals with concentrations above the identified ARARs or TBCs.

Parameter	Units	Number of Analyses	Number of Detects	Maximum Detected Concentration	Criteria Type	Criteria Level	Number of Exceedances
Aluminum	µg/L	4	1	12200	SEC	50	1
Antimony	µg/L	4	3	6.9	GA	3	3
Iron	µg/L	4	4	4470	GA	300	1
Manganese	µg/L	4	2	76.7	SEC	50	1
Sodium	µg/L	4	4	62200	GA	20000	3

SEC = USEPA Secondary Drinking Water Regulations, identified as TBCs

GA = NYSDEC Class GA Groundwater Standards, identified as ARARs

August 2004 Sampling Event

13 metals were detected in SEAD-71 groundwater during the August 2004 sampling event (**Table 4-6B**). Below lists the metals with concentrations above the identified ARARs or TBCs.

Parameter	Units	Number of Analyses	Number of Detects	Maximum Detected Concentration	Criteria Type	Criteria Level	Number of Exceedances
Aluminum	µg/L	3	2	146	SEC	50	2
Manganese	µg/L	3	3	2680	SEC	50	1
Sodium	µg/L	3	3	48200	GA	20000	1

SEC = USEPA Secondary Drinking Water Regulations, identified as TBCs

GA = NYSDEC Class GA Groundwater Standards, identified as ARARs

5.0 CONTAMINANT FATE AND TRANSPORT

This section presents a site-specific conceptual site model, summarizes the chemical impacts present in soil and groundwater at SEAD-59 and SEAD-71, and describes the potential transport of contaminants from these sites. The section is organized into four subsections. **Sections 5.1 through 5.3** present conceptual site model for SEAD-59, the SEAD-59 stockpile soil, and SEAD-71. **Section 5.4** illustrates the fate and transport of individual contaminants at these areas.

5.1 SEAD-59 CONCEPTUAL SITE MODEL

The conceptual site model defines the physical and chemical characteristics for SEAD-59. This conceptual site model was based on the review of the historical site information and the data collected during the previous site investigations (i.e., ESI, the time-critical removal action, and the 2004 groundwater monitoring). The data collected include geophysical survey data, field observations, and analytical data.

5.1.1 Summary of SEAD-59 Physical Characteristics

The physical characteristics of SEAD-59 have been described in **Section 1**. In summary, SEAD-59 (Fill Area West of Building 135) is located in the east-central portion of the Seneca Army Depot Activity facility near the Administration Buildings (see **Figures 1-2** and **1-3**). An unnamed dirt road to Building 311 crosses the site east-to-west separating the two distinct areas north and south of the road. The area to the south is covered with vegetation and trees, and slopes down to the west. The area to the north slopes down to the northwest. A 60,000-gallon aboveground oil storage tank and Building 128 are to the east of the area north of the unnamed dirt access road. The aboveground storage tank (AST) is surrounded by an earthen levee with a poly liner covering the inside walls and floor. It is unknown whether the AST has been emptied or other remedial activities have occurred. A north-south running drainage ditch abuts the site to the west; and railroad tracks running west-to-east abut the site to the north. Drainage ditches are also located on both sides of the access road to Building 311 and sloped east-to-west to promote flow into the drainage ditch along the western border of the site.

During the 2002 TCRA, areas located in north and south of the unnamed dirt road were excavated and backfilled; more than 14,000 cubic yards (cy) were excavated and over 6,500 cy were backfilled.

The predominant surficial geologic unit present at the site is composed of till, weathered dark gray shale, and competent gray-black shale. Weathered shale forms the transition between till and competent shale in some locations based on soil borings. Very little topsoil was encountered during subsurface investigations at SEAD-59. The thickness of the till ranged from 3 to 9 feet. Fill material is present in the area north of the access road. The fill was characterized as being lithologically similar to the underlying till: it was characterized as silt containing minor components of sand and shale fragments. The fill was found to extend to a depth of 10.5 feet in select places. During the 2002 TCRA, a total volume of 18,900 cy soil in the north area was excavated and was backfilled with excavated material that was deemed appropriate for backfill.

The groundwater in the overburden aquifer at SEAD-59 flows towards the southwest. The distribution of groundwater in the overburden aquifer is characterized by saturated soil in the lower till strata and the weathered shale. Till, including the weathered shale immediately below the till, and the underlying competent shale are two distinct geologic units at SEAD-59 that store and transmit groundwater. The till and weathered shale behave as a single unconfined hydrological unit. It is apparent from the groundwater contours and saturated thickness of the till/weathered shale aquifer that seasonal precipitation events and depth to bedrock influence the groundwater flow direction. The topography of the SEDA base also influences the groundwater flow. SEAD-59 is located on the eastern-central portion of the SEDA base, which is on a small mountain between the Seneca and Cayuga Lakes near the rounded top. Its location results in the depth to bedrock less than 10 feet in some locations.

Meteorological and physical site conditions that may impact the fate and transport of contaminants at SEAD-59 are described in **Section 1**.

5.1.2 Summary of SEAD-59 Chemical Impacts

Soils at SEAD-59 have been impacted by metals and semivolatile organic compounds (mainly PAHs). The TCRA activities at the site have greatly reduced the impacts; however, some residual levels of these compounds still exist.

A discussion of current chemical impacts to the site is presented in **Section 4.2** of this report. In brief, soils were impacted primarily by metals and PAHs (refer to **Table 4-1A/B**). Subsurface soils (2-15 ft bgs) were impacted by PAHs and metals, but to a less degree than the surface soils (0-2 ft bgs.). Pesticides (4,4'-DDE and 4,4'-DDT), 4-chloroaniline, and acetone were detected above the associated TAGM values, but the low frequency of detection suggested that these chemicals were not pervasive and that these chemicals were unlikely related to any release at the site.

There is no evidence that groundwater has been substantially impacted by VOCs, SVOCs, or pesticides/PCBs at the site; while elevated metal concentrations (i.e., compared with the ARARs or

TBCs) were observed in SEAD-59 groundwater. As summarized in **Section 4.2.3** and shown in **Table 4-2A** and **Table 4-2B**, all 2004 groundwater results were below the identified ARARs or TBCs for VOCs, SVOCs, and pesticides/PCBs. The groundwater results for all metals were below the identified ARARs or TBCs with the exception of antimony, iron, sodium, aluminum, and manganese. The groundwater concentrations of antimony, iron, and sodium exceeded the NYSDEC Class GA Groundwater Standards and the groundwater concentrations of aluminum and manganese were above the USEPA Secondary Drinking Water Standards.

5.1.3 Conceptual Model Summary

Residual levels of metals and PAHs in site soils were elevated compared to the NYSDEC TAGM values. Subsurface soils were less impacted compared with surface soil (i.e., the number of exceedances is significantly less and the concentrations were much lower in subsurface soils). Several metals (antimony, iron, sodium, aluminum, and manganese) were detected in groundwater with concentrations above the identified ARARs or TBCs. **Section 5.4** presents the fate and transport of metals and PAHs in soil and groundwater.

5.2 SEAD-59 STOCKPILE SOIL CONCEPTUAL SITE MODEL

The conceptual site model defines the physical and chemical characteristics of SEAD-59 Stockpile soils. The soil stockpiles are located within the SEAD-59 site boundary and are contained within engineering barriers (i.e. sand base, earthen or hay bale berms, and poly liner). **Figure 2-7** shows the stockpile staging areas at SEAD-59. This conceptual site model was based on the stockpile soil data collected during the 2002 TCRA.

5.2.1 Summary of SEAD-59 Stockpile Soil Physical Characteristics

The SEAD-59 Stockpiles are piles of soil excavated from SEAD-59 that were not backfilled or disposed off-site during the 2002 TCRA. These soils were analyzed during the TCRA and the results are provided in **Appendix A, Table A-6**. The stockpiles were placed in five separate staging areas at SEAD-59. The approximate stockpile locations are shown in **Figure 2-7**.

The soil stockpiles consist of soil removed from the excavation areas at SEAD-59 site. The piles are free of debris as debris was visually screened out during excavation process and prior to stockpile placement. The predominant soil present within the piles are till, weathered dark gray shale, and competent gray-black shale. The soil stockpiles are exposed with no protective cover and seasonal vegetation has grown over the piles.

Prior to stockpile placement during the TCRA, a sand base was laid down over the staging areas, the area was inspected for debris, and berms were constructed either of site material or hay bales. A poly

liner was placed over the sand base and the seams were welded. Excavated soil was placed on top of the 20-mil poly liner, while some of the smaller stockpiles (stockpiles at Area 4 Staging and Building 128) used four layers of 6-mil poly liner.

Precipitation is expected to migrate through the stockpiles, runoff the surface of the stockpiles, be retained by vegetation on top of the stockpile, and be lost to evaporation. Water absorbed by the stockpiles is expected to migrate downward through the pile till the poly liner is encountered; and then laterally spread out. Pools of standing water have not been observed during site visits and it is believed that standing water is not present at any of the stockpiles.

Protective berms and hay bales used to mitigate run-off water from the stockpiles have been in placed since the TCRA. The stockpiles have eroded and vegetation has grown over much of the piles. Some portions of the piles may have eroded and expanded beyond the poly liner. The hay bale berms have visibly deteriorated since their placement.

5.2.2 Summary of SEAD-59 Stockpile Soil Chemical Impacts

SEAD-59 stockpile soils were mainly impacted by metals and PAHs. A detailed discussion of the soil results can be found in **Section 4.3**. In brief, 23 metals were detected in stockpile samples and 12 metals were detected above the TAGM values. The concentrations of the carcinogenic PAHs exceeded the TAGM values in at least 19 stockpile samples. The average cPAH BTE concentration in stockpile soil was 8.07 mg/kg.

5.2.3 Conceptual Model Summary

Based on the stockpile soil analytical results presented in **Section 4**, metals and PAH concentrations in stockpile soils were relatively high compared with the TAGM values. There is potential of water run-off contact with the soils due to the eroded barrier system around the stockpiles. **Section 5.4** presents the fate and transport of metals and PAHs in SEAD-59 stockpile soil.

5.3 SEAD-71 CONCEPTUAL SITE MODEL

The conceptual site model defines the physical and chemical characteristics for SEAD-71. This conceptual site model was based on the review of the historical site information and the data collected during the previous site investigations (i.e., ESI, the time-critical removal action, and the 2004 groundwater monitoring). The data collected include geophysical survey data, field observations, and analytical data.

5.3.1 Summary of SEAD-71 Physical Site Characteristics

The physical characteristics of SEAD-71 have been described in **Section 1**. In brief, SEAD-71 (i.e., the Alleged Paint Disposal Area) is located in the east-central portion of SEDA. The site is approximately 2 acres, located west of 4th Avenue near Buildings 127 and 114, and bounded on the north and south by railroad tracks serving Buildings 114 and 127 (see **Figures 1-2** and **1-4**). A chain-link fenced area is situated between Building 114 and 127; and a single railroad track bisects the area west-to-east. The topography is relatively flat with a gentle slope to the southwest.

During the 2002 TCRA, approximately 663 cy of soil was excavated from SEAD-71 and the excavated areas were later backfilled with excavated material that was deemed appropriate for backfill.

The predominant surficial geologic unit present at the site is composed of till, calcareous weathered shale, and competent shale. Large shale fragments (rip-up clasts) were observed at or near the till/weathered shale contact at all soil boring locations. In the western half of the site, the till consisted of olive gray silt and was found to be approximately 4 feet thick. The depth of the weathered shale ranged from 5 to 8 feet bgs. Competent, calcareous gray shale was encountered at depths between 5 and 9 feet bgs.

The Fenced Area is generally paved over or covered with crushed stone; pieces of asphalt and concrete were observed on the ground surface based on the field notes recorded during the Phase I investigation. The Fenced Area had till characterized as olive gray clay with little silt, very fine sand, and shale fragments (up to 1 inch in diameter) and ranged in thickness from 5 and 8 feet. In the southern section of the Fenced Area, the till consisted of light brown silt with little clay and trace amounts of shale fragments (up to 1 inch in diameter).

The groundwater flow direction in the till/weathered shale aquifer on the site is to the west-southwest based on groundwater elevations. Recharge of water to the monitoring wells during groundwater sampling was generally poor. Three of the four groundwater monitoring wells (MW71-1, -2, and -3) have measured saturation thickness of less than 4 feet during the 2004 sampling events. SEAD-71 is located in the eastern-central portion of the SEDA base, which is on a small mountain between the Seneca and Cayuga Lakes near the rounded top. Its location results in the depth to bedrock less than 10 feet in some locations.

Meteorological and physical site conditions that may impact the fate and transport of contaminants at SEAD-71 are described in **Section 1**.

5.3.2 Summary of SEAD-71 Chemical Impacts

Soils at SEAD-71 have been impacted by metals, PAHs, and pesticides. The TCRA activities at the site have greatly reduced the impacts; however, some residual levels of these compounds still exist.

A discussion of current chemical impacts to the site is presented in **Section 4.4** of this report. In brief, soils were impacted primarily by metals, PAHs, and pesticides (refer to **Table 4-5A/B**). Subsurface soils (2-15 ft bgs.) were impacted by PAHs and metals, but to a less degree than the surface soils (0-2 ft bgs.). Endrin and heptachlor were detected above the associated TAGM values, but the low frequency of detection (14% and 17%, respectively) suggested that these chemicals were not pervasive and that these chemicals were unlikely related to any release at the site.

The site-wide average cPAH BTE concentration in surface soil was 11.64 mg/kg while the average BTE concentration in surface soil outside the Fenced area was 1.64 mg/kg. The site-wide average BTE concentration in subsurface soil was 5.39 mg/kg. The cPAH BTE concentrations for seven out of 14 surface soil samples (or seven out of 12 locations) within the Fenced Area were above 10 mg/kg (**Figure 4-1**). The maximum lead concentration (3,470 mg/kg) was detected in surface soil within the Fenced area at SS71-16 and appeared to be an isolated hit (see **Figure 4-2**). The next two highest concentrations were 572 and 346 mg/kg, detected in surface soil next to SS71-16 within the Fenced Area at SS71-19 and SS71-20. The lead concentrations detected in subsurface soil samples from test pit TP71-2 within the Fenced Area did not exceed the NYSDEC TAGM value. The average lead concentration within the Fenced Area was 350 mg/kg, which was lower than the USEPA (1998) recommended 400 mg/kg screening level for lead in soil at residential properties.

Elevated concentrations (relative to the identified ARARs or TBCs) of five metals (aluminum, antimony, iron, manganese, and sodium) and one SVOC (4-nitroaniline) were observed in SEAD-71 groundwater during the 2004 sampling events. Detailed discussion is summarized in **Section 4.5.3**.

5.3.3 Conceptual Model Summary

Residual levels of metals and PAHs in site soils were elevated compared to the NYSDEC TAGM values. Subsurface soils were less impacted compared with surface soil (i.e., the number of exceedances is significantly less and the concentrations were much lower in subsurface soils). Soil outside the Fenced Area was less impacted compared with soil within the Fenced Area. Several metals (antimony, iron, sodium, aluminum, and manganese) and one SVOC (4-nitroanilin) were detected with concentrations above the identified ARARs or TBCs in groundwater. **Section 5.4** presents the fate and transport of metals and PAHs in soil and groundwater.

5.4 SEAD-59 AND SEAD-71 CONTAMINANT FATE AND TRANSPORT

Contaminant fate and transport refers to the chemical characteristics and predictable behaviors within different media at a site. **Section 5.4.1** presents a discussion of the fate and transport characteristics for common chemical classes at SEAD-59 and SEAD-71. **Section 5.4.2** discusses the fate and transport properties of specific compounds identified for each site. The chemical analytical results for SEAD-59 and SEAD-71 are presented in **Appendix A** and summarized in **Section 4**.

Anomalies and environmental impacts within SEAD-59 and SEAD-71 appear to be retained within the soil matrix. VOC, SVOC, pesticide, and PCB groundwater standards/guidance values were not exceeded in any sample with the exception of 4-nitroaniline (8.7 ug/L vs. 5.0 ug/L guidance value). A total of seven analytes (toluene, 4,4'-DDE, 4,4'-DDT, 1,1,1-trichloroethane, di-n-butylphthalate, bis(2-ethylhexyl)phthalate, and 4-nitroaniline) were detected; however, the concentrations were below the NYSDEC Class GA groundwater standards or guidance values. Although concentrations of several metals were above the identified ARARs or TBCs, these metals are not expected to pose a significant risk (see **Section 6** and **Section 7**). As a result, no groundwater transport modeling was performed as part of the chemical fate and transport analysis.

5.4.1 Overview of Fate and Transport Mechanisms

This section presents fate and transport mechanisms and physical and chemical properties for two general chemical groups - metals and organic compounds. The information provided in this section is helpful for chemical fate and transport evaluation.

5.4.1.1 Fate and Transport Mechanisms for Metals

The major fate and transport mechanisms for metals include complexation, adsorption, precipitation, oxidation, and reduction.

All soils naturally contain trace levels of metals. The concentration of metals in “uncontaminated” soils is primarily related to the geology of the parent material from which the soil was derived. Therefore, the metal concentrations in soil can vary significantly depending on the composition of the parent bedrock material. Background concentrations for metals in till at SEDA have been established through an extensive sampling program as discussed in **Section 6.3.2** (background sample data are included in **Appendix B**).

The mobility of metals within a soil system is primarily associated with the movement of water through that system. This mobility is associated with the solubility of the metal and its compounds, as well as chemical parameters affecting the oxidation state of the metal in solution. Metals associated with the aqueous phase of soil are subject to movement with soil water, and may be

transported through the vadose zone to groundwater. However, the rate of migration of the metal usually does not equal the rate of water movement through the soil due to fixation and adsorption reactions (Dragun, 1988). Metals, unlike organic compounds, can not be degraded (McLean and Bledsoe, 1992). Metals become immobile due to mechanisms of adsorption and precipitation.

Mechanisms of adsorption and precipitation inhibit the mobility of metals in groundwater. Metal-soil interactions are such that when metals are introduced at the soil surface, downward transportation does not occur to any great extent unless the metal retention capacity of the soil is overloaded, or metal interaction with the associated waste matrix enhances mobility. Changes in soil environment conditions over time, such as the degradation of the organic waste matrix, changes in pH, oxidation-reduction potential, or soil solution composition, due to natural weathering processes, also may enhance the mobility of metals. The extent of vertical impacts is intimately related to the soil solution and surface chemistry of the soil matrix with reference to the metal.

In soils, metals are found in one or more of several categories in the soil. These categories as defined by Shuman (1991) are as follows:

- dissolved in the soil solution;
- occupying exchange sites on inorganic soil constituents;
- specifically adsorbed on inorganic soil constituents;
- associated with insoluble soil organic matter;
- precipitated as pure or mixed solids;
- present in the structure of secondary minerals; and/or
- present in the structure of primary minerals.

In situations where metals have been introduced into the environment through human activities, metals are usually associated with the first five categories. Native metals may be associated with all the above categories depending on the geological history of the area. The aqueous fraction, and those fractions in equilibrium with this fraction (i.e., the exchange fraction) are of primary importance when considering the migration potential of metals associated with soils.

The following paragraphs discuss general aspects of adsorption and leaching of metals in soil. In general, the clay minerals within most soils possess a negative charge (Dragun, 1988). This is due to the polarity of the clays and their interactions with soil moisture (water), as well as other cations (positively charged ions) and anions present in the soil. These negatively charged positions on clay minerals are responsible for attracting cationic species of elements at the soil surface.

In addition, humus is also responsible for the accumulation of ionic species of elements at soil surfaces. Humus is the relatively stable fraction of soil organic matter that remains in soil after the chemicals comprising the plant and animal residues have decomposed (Dragun, 1988). Humus is

colloidal in structure and the colloid surface possesses functional groups that possess negative charges. These charges are responsible for accumulating cationic species of elements at soil surfaces.

The process by which a cation in water is attracted to a soil surface and displaces another cation is known as ion exchange. The term cation exchange specifically refers to the exchange between cations balancing the surface charge on the soil surface and the cations dissolved in water (Dragun, 1988). The total amount of cations adsorbed by these negative charges on a unit mass of soil is defined as the cation exchange capacity of the soil (CEC), which is a stoichiometric and reversible process (Dragun, 1988).

The process by which a cation combines with molecules or anions containing free pairs of electrons is known as complex formation (Dragun, 1988). The cation-anion or cation-molecule combination is known as a complex. The anion(s) or molecule(s) with which the cation forms a complex is usually referred to as a ligand.

According to Dragun (1988), the equilibrium distribution of a cation is governed by two opposing rate processes, the adsorption rate and the desorption rate. The adsorption rate is the rate at which the dissolved cation in water transfers into the adsorbed state. The desorption rate is the opposite process; it is the rate at which the cation transfers from the adsorbed state into water. The extent of adsorption is expressed using the adsorption coefficient or distribution coefficient, K_d . The distribution coefficient is defined as the ratio of the concentration of a solute adsorbed on soil surfaces to the concentration of the solute in water. The greater the extent of adsorption, the greater the magnitude of K_d . The K_d values are dependant such characteristics as ionic size and valence, varying with these characteristics for each metal.

The chemistry and migration of all cationic metals in soil is controlled by pH. At soil pH of greater than 6.5, those metals normally present as cations, are fairly immobile. At higher pH values, cationic metals often form insoluble carbonate and hydroxide complexes. However, some metals (e.g., arsenic and uranium) may form mobile anionic complexes. Cationic metals are most mobile in highly acidic soils, e.g., those with a pH of 5 or less. Anionic metals are most mobile where the soil pH is greater than 7.0.

The average pH of soil collected from stockpile samples during the 2002 TCRA at SEAD-59 and SEAD-71 are 8.11 and 8.18, respectively. Groundwater pH was measured in the field as an indicator parameter during the April and August 2004 sampling events and is summarized in the table below.

SEAD-59 and SEAD-71 Groundwater pH Field Measurements						
	April-04			August-04		
Well ID	Sample ID	pH ¹	Temperature (°C)	Sample ID	pH ¹	Temperature (°C)
MW59-1	592000	7.78	5.84	-	NS	
MW59-2	592001	7.95	6.54	592006	6.51	15.30
MW59-3	592002	7.67	5.35	592007	4.25	18.80
MW59-4	592003	7.69	5.68	-	NS	
MW59-6	592004	7.71	6.16	592009	6.95	16.30
MW59-7	-	NS		592005	7.36	18.10
MW59-8	-	NS		592008	7	16.60
SEAD-59 Average pH 7.76				6.41		
MW71-1	712000	IY		712007	6.38	26.30
MW71-2	-	NS		712004	6.46	21.40
MW71-3	712001	IY		712005	IY	
MW71-4	712002	7.74	6.75	712006	6.11	15.10
SEAD-71 Average pH 7.74				6.32		
Notes: 1) pH value was not corrected for temperature. NS - Not Sampled, usually due to insufficient groundwater yield or re-charge IY - Insufficient Yield for field indicator parameter measurement.						

General trends of element mobility using the published results for studies of 10 soils (Dragun, 1988) include:

- Cations and anions exhibit low mobility in clay and silty clay soils. As the surface areas and the clay content increases, the ability of the soil to retain cations and anions will generally increase.
- Cations usually exhibit moderate to high mobility in sandy, loamy sand, and sandy loam soil.
- Cations can exhibit low, moderate, or high mobility in soils with intermediate textures.
- Anions usually exhibit relatively low mobility in clay and silty clay soils and moderate to high mobility in other soil types.

Soils at SEAD-59 and SEAD-71 generally contain silt and clay content and thus decrease mobility of cations and anions compared with sandy soils.

The leaching of a metal from soils is substantial if the metal exists as a soluble salt. In general, metallic oxides are considered to be less likely to leach metallic ions than metallic salts. Leaching is not expected to be a significant transport mechanism at SEAD-59/71, which is evidenced by the Toxicity Characteristic Leaching Procedure (TCLP) results. TCLP analyses were performed for some samples collected during the 2002 TCRA. A summary of the TCLP analysis results along with the organic and inorganic analysis results is presented in **Table A-10A/B** in **Appendix A**. With the exception of barium and lead, none of the metals analyzed (arsenic, cadmium, chromium, mercury,

selenium, and silver) were detected in any of the TCLP samples. The TCLP barium results were all much lower than the regulatory level of 100,000 ug/L. The TCLP lead results for all but two samples collected from SEAD-71 were below the regulatory level of 5,000 ug/L. Soil associated with the two TCLP lead exceedances were disposed off-site during the 2002 TCRA. It should be noted that the TCLP analysis was performed by subjecting the sample to acetic acid, which was chosen to simulate landfill leachate. The pH of the acetic acid buffer solution is maintained at 4.93, which was generally much lower than the pH in soil or groundwater at SEAD-59/71. Therefore, metal leaching potential at the sites is expected to be much lower than the potential based on TCLP analysis. Nonetheless, the TCLP results overall indicated that leaching would not be a significant transport mechanism at SEAD-59/71.

Section 5.4.2.1 provides an overview of the characteristics that affect the fate and transport of each of the metals present above ARARs or TBCs at SEAD-59 and SEAD-71.

5.4.1.2 Fate and Transport Mechanisms for Organic Compounds

The organic compounds that will be addressed in this section include VOCs, SVOCs, and pesticides/PCBs.

Site conditions and the compounds' chemical and physical properties will, in combination, determine the compound mobility within a media.

Important soil properties that may affect organic compounds fate and transport include fraction of organic carbon in soil, soil mineralogy, and soil porosity. Many organic compounds adsorb strongly to organic fraction in soil. Therefore, the larger the amount of organic compounds in the soil, the less mobile organic constituents will be (i.e., soils with higher organic content will adsorb more organic compounds than soils with less organic content). Generally, surface soils will have higher organic content than deeper soils, due to the presence of live and dead plant matter at the surface.

One measure of the affinity of a compound for the organic fraction of the soil is the organic carbon partition coefficient, K_{oc} . The K_{oc} is the ratio of the amount of the compound present in the organic fraction to that present in the aqueous fraction. **Table 5-1** describes the relative relationship between K_{oc} and mobility. Compounds with a K_{oc} between 500 ml/g and 2000 ml/g are generally considered to have low mobility in soil and compounds with a K_{oc} greater than 2000 ml/g are considered to be immobile in soil (Dragun, 1988).

Some organic compounds adsorb more strongly to the clay fraction of a soil. Understanding the type and amount of clays present is crucial to estimating the mobility of the compounds. Most of the soils at SEDA are classified as clay loam. These soils generally have low permeability and high water retention capabilities. Because of these properties, contaminants tend to move slowly through these soils.

Volatile Organic Compounds

VOCs are characterized by relatively high vapor pressures and Henry's Law constants, indicating a strong potential for volatilization. Volatile constituents will enter the air in void spaces in the soil above the saturated zone. These constituents may then leave the system through the ground surface. The tendency of compound to volatilize is usually expressed in terms of a Henry's Law constant K_H . Henry's Law holds in cases where the solute concentration is very low. Henry's Law states that the concentration of a constituent in the vapor phase is directly proportional to the concentration of that constituent in the aqueous phase. The proportionality factor is the Henry's Law constant. Generally, for compounds with a Henry's Law constant less than 5×10^{-3} , volatilization from the soils will not be a major pathway (Dragun, 1988).

VOCs tend to have a low residence time in surface soil and surface water environments. These chemicals can be persistent in groundwater. However, there is evidence that non-chlorinated VOCs may degrade rapidly in the vadose zone above groundwater (Gas Research Institute, Management of Manufactured Gas Plant Sites, Volume III, Risk Assessment, May 1988, GRI-87/0260.3).

Major VOC exposure routes include groundwater intake and gas inhalation. The latter can be important in situations involving excavation or the entrainment of soil gas into buildings. There is little potential for these chemicals to accumulate in aquatic or terrestrial biota.

The organic partition coefficients, K_{oc} , for volatile organic compounds vary from being highly mobile to being only moderately mobile. VOCs such as acetone has a K_{oc} of 1 whereas xylenes has a K_{oc} ranging in value from 39 to 365 depending on the soil and pH.

Semivolatile Organic Compounds

SVOCs are characterized by low vapor pressures and low Henry's Law constants, indicating little potential for volatilization. High sorption coefficients indicate that these chemicals will tend to stay sorbed to soil. TCLP analysis was conducted for SVOCs for several soil samples collected during the 2002 TCRA (i.e., FD-59-WS-02, FD-59-WS-07, WS-59-01-003-6, WS-59-01-003-7, WS-59-01-004-2, WS-59-01-004-3, WS-59-01-004-4, WS-59-01-004-5, WS-59-01-004-6, WS-59-01-005-1, WS-59-01-005-2, WS-59-01-005-3, WS-59-01-005-4, and WS-59-01-006-10) and no constituents were detected. Therefore, leaching of SVOCs to groundwater is not expected to be a significant transport mechanism at the sites.

PAH compounds are a major group of SVOCs. PAHs have a high affinity for organic matter and low water solubility. Most PAHs have K_{oc} values greater than 2,000 ml/g. Water solubility tends to decrease and affinity for organic material tends to increase with increasing molecular weight (Gas

Research Institute, 1988). As an example, naphthalene is much more soluble in water than is benzo(a)pyrene. When present in soil, PAHs tend to remain bound to the soil particles and dissolve only slowly into groundwater or the overlying water column. Because of the high affinity for organic matter, the physical fate of PAHs is usually controlled by the transport of particulate. Thus, soil and suspended soil particulate matter (in air) represent important media for the transport of PAHs.

PAH compounds are readily taken up (bioaccumulated) by living organisms. However, organisms have the potential to metabolize the chemicals and to excrete the polar metabolites (Gas Research Institute, 1988). The ability to do this varies among organisms.

Several factors can degrade PAH compounds in the environment. Biodegradation on soil microorganisms is an important process affecting the concentrations of the chemicals in soils and water. Volatilization may also occur. This mechanism is effective for the lighter molecular weight compounds. However, the volatilization of higher molecular weight PAH compounds occurs slowly.

Pesticides/PCBs

The pesticide compounds are all expected to be highly immobile in the soil/groundwater environment when present at low dissolved concentrations (BELA, 1989). Bulk quantities of these compounds dissolved in an organic solvent could be transported through the unsaturated zone as the result of a spill. However, their extremely low solubility and their strong tendency to sorb to soils results in a very slow transport rate in soils.

5.4.2 Fate and Transport of Specific Compounds at SEAD-59 and SEAD-71

The following sections discuss the fate and transport mechanisms for specific compounds found at SEAD-59 and SEAD-71. Analytes detected in soil or groundwater with exceedances of ARARs or TBCs are discussed in the subsequent sections by chemical class. Unless otherwise specified, the fate and transport information is from the Hazardous Substances Data Bank (HSDB), a database developed by National Library of Medicine.

5.4.2.1 Metals

Aluminum

Aluminum is the most abundant element in the earth's crust. In nature, aluminum does not occur as a free element but occurs combined with other elements as aluminum compounds. Some of the most common aluminum compounds found in nature are aluminosilicates, oxides, and hydroxides. These compounds may be found in rock, minerals, clays, and soil. The behavior of aluminum ions and compounds in the environment depends upon their coordination chemistry and the characteristics of

the local environment such as pH. The major features of the biogeochemical cycle of aluminum include: leaching of aluminum ions from soil and minerals into aqueous environments; adsorption and/or precipitation of aluminum ions and compounds onto soil; and wet and dry deposition aluminum-containing dust particulates from the air to land or surface water. Volatilization of aluminum compounds from moist soil surfaces is not an important fate process because these compounds are ionic and will not volatilize.

Antimony

In soil antimony transport is controlled by the form of antimony, soil pH, and soil composition. Antimony bonds strongly with soil particles; the presence of iron, manganese, and aluminum may lead to the formation of hydroxylated oxides within the soil or groundwater. Organic carbon content does not have a significant influence on the absorption capacity of antimony to soil.

Arsenic

In soil arsenic exists as either arsenate, As(V), or arsenite, As(III); however, arsenite is the more toxic form. Arsenite compounds are reported to be 4 to 10 times more soluble than arsenate compounds (McLean and Bledsoe, 1992).

The adsorption of both forms of arsenic is strongly pH dependent. Griffin and Shimp (1978) found that arsenate had a maximum adsorption in soils with a pH of 5. These same researchers found that arsenite sorption was observed to increase over a pH range of 3 to 9. Other researches found the maximum adsorption of As(III) by iron oxide occurred at pH of 7.

Both pH and redox are important in assessing the fate of arsenic in soil. At high redox levels, As(V) predominates and arsenic mobility is low and as the pH increases or the redox decreases As(III) predominates (McLean and Bledsoe, 1992). The reduced form of arsenic is more subject to leaching because of its high solubility. Arsenite can be oxidized to As(V) and manganese oxides are the primary electron acceptor in this oxidation (Oscarson et al., 1983).

Barium

Barium is a naturally occurring element found in the earth's crust that enters the environment through the weathering of rocks and minerals. Soluble barium compounds, such as barium nitrate, barium cyanide, barium permanganate, and barium chloride, are expected to be mobile in the environment. Soluble barium can react with sulfates and carbonates in water forming insoluble barium sulfate and barium carbonate salts.

Beryllium

Beryllium occurs naturally in the earth's crust, in coal, and in minerals. Particulate-phase beryllium may be physically removed from the air by wet and dry deposition. Soluble beryllium salts will be hydrolyzed to form insoluble beryllium hydroxides. Under typical environmental conditions, the hydroxo-complex BeOH^+ and Be^{2+} , are expected to be the dominant dissolved species. $\text{Be}(\text{OH})_2$ is expected to precipitate from water given its low solubility at the pH range of most natural systems. Beryllium may adsorb to suspended mineral solids and sediments in water based upon soil studies. If released to soil, beryllium is expected to be essentially immobile.

Cadmium

Cadmium may be adsorbed by clay minerals, carbonates, or hydrous oxides or iron and manganese or may be precipitated as calcium carbonate, hydroxide, and phosphate. Evidence suggests that adsorption mechanisms may be the primary source of cadmium removal from soils. Several authors have reported that in soils polluted with metals wastes, the greatest percentage of the total cadmium was associated with the exchangeable fraction (McLean and Bledsoe, 1992). As with all cationic metals, the chemistry of cadmium in the soil environment is to a greater extent controlled by pH. Under acidic conditions cadmium solubility increases and very little adsorption of cadmium by soil colloids, hydrous oxides, and organic matter takes place. At pH values greater than 6, cadmium is adsorbed by the soil solid phase or is precipitated, and the solution concentrations of cadmium are greatly reduced. Cadmium forms soluble complexes with inorganic and organic ligands. The formation of these ligands will increase the mobility of cadmium in soils.

Calcium

Calcium compounds may enter the atmosphere in the form of dust or other fine particles. Particulate-phase calcium will be removed from the atmosphere by wet and dry deposition. Calcium compounds, except for calcium phosphate and sulfate, have high water solubilities and are expected to have high mobility in soil. Since calcium compounds have extremely high water solubilities, except for calcium sulfate and phosphate, and extremely low vapor pressures, they are not expected to volatilize from either moist soil surfaces or surface waters. The bioaccumulation of calcium in organisms is highly dependent on its availability for uptake by the organisms. Chemical properties which would affect the availability of calcium uptake include pH, ionic strength and concentration of other solutes in the aqueous media.

Chromium

Chromium occurs naturally in soils and rocks. It may occur in either of two oxidation states; trivalent, Cr(III), or hexavalent, Cr(VI). While Cr (III) is the more stable and common form, hexavalent chromium is the more toxic.

Trivalent chromium is readily adsorbed by soils, exhibiting typical cation sorption behavior. Under normal pH and oxidation-reduction conditions, chromium (III) minerals of oxides and hydroxides are stable and insoluble. Hexavalent chromium can be reduced to Cr(III) under normal soil pH and oxidation-reduction conditions and soil organic matter has been identified as the electron donor in this reaction (Bartlett and Kimble, 1976; Bloomfield and Pruden, 1980). Barlett and James (1979) showed that Cr(III) could be oxidized under conditions prevalent in some soils.

Forms of Cr(VI) in soil are immobilized at pH values of less than 6.5. Because of the anionic structure of Cr(VI), its association with soil surfaces is limited to positively charged exchanges sites, the number of which decreases with increasing soil pH (McLean and Bledsoe, 1992). Generally, hexavalent chromium compounds are readily soluble; however, some researches have found that clay soil, containing free iron and manganese oxides, significantly retarded Cr(VI) migration. Cr(VI) was also found to be highly immobile in alkaline soils.

Cobalt

Traces of cobalt are found in all rocks, minerals, and soils. Cobalt always occurs in nature in association with nickel, and usually also with arsenic. Cobalt is a component of vitamin B12, and is essential for all higher animals including humans. Ionic cobalt compounds would exist in the particulate phase in air, and these compounds may be removed from the air by wet and dry deposition. Common oxidation states of cobalt are +2 and +3. Soils with higher pH and contents of clay, natural organics, and hydrous manganese and iron oxides, bind cobalt to a greater degree; as these factors decrease, the mobility of cobalt increases. Chelating agents, which are compounds that bind metal ion (i.e., ethylenediamine tetraacetic acid, EDTA), increase the solubility of cobalt and enhance mobility of cobalt in soil. Cobalt compounds would not volatilize from water or moist or dry soil surfaces, due to their ionic character. The predominate cobalt species in unpolluted freshwater are: Co^{2+} , the carbonate, hydroxide, sulfate, adsorbed forms, oxide coatings, and crystalline sediments. In aqueous solution in the absence of complexing agents, the oxidation of the hexaaquacobalt(II) ion to Co(III) is very unfavorable. In the presence of complexing agents, such as ammonia which forms very stable complexes with Co(III), the stability of Co(III) is improved. Co(III) is inert to ligand exchange relative to Co(II).

Copper

The degree of persistence of copper in soil depends on the soil characteristics and the forms of the copper that are present. Copper is retained in soils through exchange and specific adsorption mechanisms (McLean and Bledsoe, 1992). This may not be the case in waste-soil systems and precipitation may be an important mechanism of retention. Copper is preferentially adsorbed by soils and soil constituents than other metals (arsenic, cadmium, nickel, zinc, mercury, silver, and selenium), with the exception of lead (McLean and Bledsoe, 1992). However, copper has a high affinity for soluble organic ligands and the formation of these complexes may enhance copper mobility in soil. Copper is not expected to volatilize from soil.

Iron

The following information is adapted from the USEPA Ecological Soil Screening Level for Iron.

Iron is the second most abundant metal in earth's crust after aluminum (about 5%). Iron can occur in either the divalent (ferrous or Fe^{+2}) or trivalent (ferric or Fe^{+3}) states under typical environmental conditions. The valence state is determined by the pH and Eh (redox potential) of the system, and the iron compound is dependent upon the availability of other chemicals.

Iron occurs predominantly as Fe^{+3} oxides in soils. The divalent state can be oxidized to the trivalent state, where it may form oxide or hydroxide precipitates. The general rule governing the mobilization and fixation of iron are that oxidizing and alkaline conditions promote the precipitation of insoluble iron Fe^{+3} oxides, whereas acidic and reducing conditions promote the solution of ferrous (Fe^{+2}) compounds. To evaluate site-specific conditions and iron fate and transport, it is recommended that the site-specific measured pH and Eh be used to determine the expected valence state of the iron and associated chemical compound and resulting bioavailability and toxicity in the environmental setting. In well-aerated soils between pH 5 and 8, the iron demand of plants is higher than the amount available. Because of this limitation, plants have evolved various mechanisms to enhance iron uptake. Under these soil conditions, iron is not expected to be toxic to plants.

Lead

Lead is one of the least mobile of the common metal contaminants in the environment. Lead is generally present in the +2 oxidation state, and will form lead oxides, although the lead itself is not degraded. Lead occurs naturally, primarily as sulfides, carbonates, and phosphates. Lead contamination may be associated with organometallic complexes associated with historical gasoline releases. Other anthropogenic sources of lead include paints, solders, and military uses.

Soluble lead added to the soil reacts with clays, phosphates, sulfates, carbonates, hydroxides, and organic matter such that lead solubility is greatly reduced. At pH values above 6, lead is either adsorbed on clay surfaces or forms lead carbonate. Generally, lead is sorbed by soils and soil constituents to the greatest extent compared to Cu, Zn, Cd, and Ni (McLean and Bledsoe, 1992). Lead has a strong affinity for organic ligands and some authors have demonstrated decreased sorption of lead to soil in the presence of complexing ligands and complexing cations.

Magnesium

Magnesium is an essential nutrient for humans, animals, and plants. Magnesium constitutes approximately 2% of the earth's crust, is eighth in abundance, and widely distributed in the environment in a variety of rock and minerals. Magnesium compounds, as ionic salts, will exist solely in the particulate phase in the ambient atmosphere. Particulate-phase magnesium compounds may be removed from the air by wet and dry deposition. Magnesium compounds in soil are removed by weathering. As soils weather, soil magnesium compounds become more soluble. Below pH 7.5, most magnesium minerals are too soluble to persist in soils. Volatilization of magnesium compounds from moist soil surfaces or surface water is not an important fate process. If released into water, magnesium compounds may be removed due to sediment adsorption.

Manganese

Manganese compounds are found in the earth's crust in the form of numerous minerals. Manganese compounds may be released by anthropogenic sources into the environment through their use as antiknock agents, antiseptics, catalysts, dietary supplements, dry cells, feed additives, fertilizers, pesticides, and pigments. Manganese is multi-valent and can exist in the 2+, 3+, 4+, 6+, and 7+ oxidation states, with 2+, 3+, and 4+ being the dominant oxidation states in the environment. Manganese 2+ is the most stable oxidation state in water while manganese 3+ and 4+ compounds are immobile solids. Organic matter may reduce manganese 3+ and 4+ compounds, resulting in the formation of soluble manganese 2+ compounds. Soluble manganese 2+ compounds do not strongly complex to soil and organic matter. Thus manganese 2+ compounds are relatively mobile and may potentially leach into surface and groundwater. As ions or insoluble solids, most manganese compounds are not expected to volatilize from water or moist soil surfaces. Manganese compounds, released into the ambient atmosphere are expected to exist in the particulate phase. In the particulate phase, manganese compounds may be removed from the air by wet and dry deposition. Manganese is an essential nutrient for most plants and animals and manganese compounds do not bioconcentrate in humans and animals.

Mercury

The distribution of mercury species in soils (elemental mercury, mercurous ions, and mercuric ions) is dependent on soil pH and redox potential (McLean and Bledsoe, 1992). Both the mercurous and mercuric cations are adsorbed by clay minerals, oxides, and organic matter. Adsorption is pH dependent, increasing with increasing pH. Mercurous and mercuric mercury are also immobilized by forming various precipitates; mercurous mercury precipitates with chloride, phosphate, carbonate, and hydroxide. At concentrations of mercury commonly found in soil, only the phosphate precipitate is stable. In alkaline soils, mercuric mercury will precipitate with carbonate and hydroxide to form a stable solid phase. At lower pH and high chloride concentrations, HgCl_2 is formed. Divalent mercury also will form complexes with soluble organic matter, chlorides, and hydroxides that may affect its mobility (Kinniburgh and Jackson, 1978).

Under mildly reducing conditions, both organically bound mercury and inorganic mercury compounds may be degraded to the elemental form of mercury, Hg^0 . Elemental mercury can readily be converted to methyl or ethyl mercury by biotic and abiotic processes (Roger, 1976, 1977). These are the most toxic forms of mercury. Some researchers have estimated that mercury can be removed due to volatilization and/or precipitation and the removal increased with pH. The volatilization was found to be inversely related to soil adsorption capacity.

Nickel

Nickel does not form insoluble precipitates in unpolluted soils and retention of nickel is, therefore, exclusively through adsorption mechanisms (McLean and Bledsoe, 1992). Nickel will adsorb to clays, iron, and manganese oxides, and organic matter and thus be removed from the soil solution. The formation of complexes nickel with both inorganic and organic ligands will affect nickel mobility in soils.

Potassium

Potassium occurs naturally in earth's crust (about 2.6% by weight). Potassium ions will neither volatilize nor degrade and all potassium compounds are water-soluble. Potassium ions are highly mobile in soils and may leach into the groundwater. Potassium ions may adsorb to soil particles. Once in groundwater, potassium ions may travel over long distances until attenuation (dispersion and dilution) decrease the concentrations, until ultimately reaching background levels.

Silver

Published data concerning the interaction of silver with soil are rare. As a cation it will participate in adsorption and precipitation reactions. Silver is very strongly adsorbed by clay and organic matter

and precipitates of silver, AgCl , Ag_2SO_4 , and AgCO_2 , are highly insoluble (Lindsay, 1979). Silver is highly immobile in the environment.

Sodium

Sodium occurs naturally in earth's crust (about 2.8% by weight). Sodium ions will neither volatilize nor degrade and all sodium compounds are water-soluble. Sodium ions are highly mobile in soils and may leach into the groundwater. Sodium ions may adsorb to soil particles, causing negative effects on soil properties (e.g., swelling and dispersion). Once in groundwater, sodium ions may travel over long distances until attenuation (dispersion and dilution) decrease the concentrations, until ultimately reaching background levels. Sodium ions may also translocate upwards through capillary rise or evaporative loss (evapotranspiration) scenarios into the rooting zone, affecting vegetative and land capability on a long-term basis (Source: <http://www.ptac.org/env/envr0501tor.html>).

Thallium

Thallium is a soft, heavy metal that is insoluble in water and organic solvents. Various thallium salts are extremely poisonous, and often used in rodenticides, fungicides, and insecticides. Thallium occurs naturally in trace amounts and is often associated with lead and zinc. Thallium is generally univalent, and may form sulfate, nitrate, and acetate salts that are moderately soluble in water.

Zinc

Zinc is stable in dry air, but upon exposure to moist air it will form a white coating composed of basic carbonate. Zinc loses electrons (oxidizes) in aqueous environments. In the environment zinc is found primarily in the +2 oxidation state. Elemental zinc is insoluble and most zinc compounds show negligible solubility as well, with the exception of elements (other than fluoride) from Group VIIa of the Periodic Table compounded with zinc (i.e., ZnCl_2 , and ZnI_2) that show a general 4:1 compound to water solubility level. In contaminated waters, zinc often complexes with a variety of organic and inorganic ligands. Therefore, the overall mobility of zinc in an aqueous environment, or through moist to wet soils, may be affected by compounding/complexing reactions.

Zinc is readily adsorbed to clay minerals, carbonates, or hydrous oxides. Several authors noted in McLean and Bledsoe (1992) found that the greatest percent of the total zinc found in "polluted" soils was associated with iron and magnesium oxides. Precipitation of zinc is not a major mechanism of retention of zinc in soils because of the relatively high solubility of zinc compounds. Precipitation may be a more significant mechanism of zinc retention in soil-waste systems. Zinc adsorption increases with pH, and hydrolyzed species are strongly adsorbed to soil surfaces. Zinc forms complexes with inorganic and organic ligands that will affect its adsorption reactions with the soil

surface (McLean and Bledsoe, 1992). Volatilization of zinc is not an important process from soil or water.

5.4.2.2 Volatile Organic Compounds

Acetone

Acetone with an estimated K_{oc} of 1 is expected to be very mobile in a soil matrix and absorption to the soil component is not expected. The Henry's Law Constant (1.87×10^{-5} atm-cu m/mol) and vapor pressure suggest that volatilization from dry and wet soil surfaces is expected to be the dominant migration pathway for acetone. The Henry's Constant also indicates volatilization from the water surface is expected to be a substantial migration pathway. In the water matrix, absorption to suspended solids or sediments is unlikely given the very low K_{oc} value of 1.

5.4.2.3 Semivolatile Organic Compounds

4-Chloroaniline

4-Chloroaniline has an affinity for soil components and a strong resistance to mineralization; it binds to the soil component via covalent bonds and polymers. A small portion of it volatilizes out from the soil; and chemical and biological actions are able to mineralize a portion of it. In the water column chemical reaction with humic materials and clay in suspended solids are expected to fixate a portion of 4-chloroaniline, and the remaining amount is volatilizes into the atmosphere.

4-Nitroaniline

4-Nitroaniline in a soil matrix either reacts with humic material forming covalent chemical bonds or to be highly mobile given experimental and estimated K_{oc} values. The humic material fixation prevents further migration by altering it to latent form. Volatilization from the soil surface is not expected based on the vapor pressure and Henry's Constant for 4-nitroaniline, however photodegradation is expected for exposed soil surfaces. In the water matrix, 4-nitroaniline is expected to be dominated by fixation to humic material or sediment.

Dibenzofuran

Dibenzofuran with a K_{oc} of 4,200 is expected to be slightly mobile in the soil matrix. The Henry's Law Constant (2.1×10^{-4} atm-cu m/mole) indicates potential of volatilization from moist soil surfaces. However, volatilization from soil is expected to be hampered by the adsorption to soil. Volatilization from dry soil is expected to be minor based upon its vapor pressure. Dibenzofuran's K_{oc} also

indicates that absorption to suspended solids and sediments is expected to detract dibenzofuran from volatilization from surface water.

PAHs

The PAHs, including but not limited to benzo(a)anthracene, benzo(a)pyrene, benzo(b)fluoranthene, benzo(ghi)pyrene, benzo(k)fluoranthene, chrysene, dibenz(a,h)anthracene, flouranthene, indeno(1,2,3-cd)pyrene, naphthalene, phenanthrene, and pyrene, were found in soils at the sites. As described in **Section 4.4.1.2**, PAHs are relatively immobile, having a high affinity for organic matter.

5.4.2.4 Pesticides/PCBs

4,4'-DDE, and 4,4'-DDT

4,4'-DDE and 4,4'-DDT are expected to be immobile within soil based upon their respective K_{oc} values. The absorption to soil will weaken volatilization from moist soil and based upon the vapor pressure volatilization from dry soil is expected to be minor. 4,4'-DDE and 4,4'-DDT are expected to be absorbed by suspended solids or sediment in the water column based on their K_{oc} values.

Endrin

Endrin with a K_{oc} of 11,420 has extremely low mobility within soil and this high K_{oc} suggests it prefers partitioning to soil than water and is considered recalcitrant in soil. The Henry's Law Constant (6.4×10^{-6} atm-cu m/mole) indicates that volatilization from moist soil surfaces is expected to act a major role in its fate. Endrin is not expected in water given its high K_{oc} and absorption to suspended solids and sediments is the preferred pathway of migration. Volatilization from the water surface takes place but absorption is the dominant partitioning processes within the water matrix.

Heptachlor epoxide

Heptachlor epoxide has a strong affinity for the soil matrix and its biodegradation opportunities are limited. Volatilization from the soil surface or photolysis may occur and downward migration is not substantial. In the water matrix absorption to suspended solids or sediment is the dominant migration pathway and volatilization from surface waters is expected limited. Biodegradation in the water matrix is not expected to be substantial compared to the absorption. Heptachlor epoxide is bioconcentrated extensively.

6.0 BASELINE HUMAN HEALTH RISK ASSESSMENT

This section of the SEAD-59 and SEAD-71 Phase II Remedial Investigation report presents the human health baseline risk assessment that was performed for the Fill Area West of Building 135 (SEAD-59) and the Alleged Paint Disposal Area (SEAD-71) at the Seneca Army Depot Activity in Romulus, New York. The ecological risk assessment is presented in **Section 7.0**.

This baseline human health risk assessment was conducted in accordance with the USEPA (1989) Risk Assessment Guidance for Superfund (RAGS) and the supplemental guidance and updates to the RAGS. Technical judgment, consultation with USEPA staff, and recent publications were used in the development of the risk assessment. The overall objective of the baseline human health risk assessment was to assess potential risks to current and reasonably anticipated future human receptors resulting from the release of, and exposure to, hazardous substances at the sites. The results of the risk assessment were used to identify whether a selected corrective action is warranted.

6.1 SECTION ORGANIZATION

This baseline human health risk assessment section is organized as follows:

1. Conceptual Site Model (**Section 6.2**)

A Conceptual Site Model (CSM) has been developed for the sites for the human health risk characterization. This section presents sources and types of contaminants present at the sites; contaminant release and transport mechanisms; affected media; potential receptors that could contact site-related contaminants in affected media under current and future land use scenarios; and potential routes of exposure.

2. Data Evaluation (**Section 6.3**)

This section identifies the site data that were included in the baseline risk assessment. Background soil and groundwater data collected from the Seneca Army Depot are presented in this section. A brief discussion of the data validation is also presented in this section.

3. Identification of Chemicals of Potential Concern (**Section 6.4**)

A site-specific screening was performed to identify chemicals of potential concern (COPCs) for each affected medium at the sites. This section presents the methodology and results of the screening.

4. Exposure Assessment (**Section 6.5**)

This section presents the exposure point concentrations (EPCs) for the affected media, plausible exposure factors for identified receptors and exposure pathways, and exposure quantitation approach for the baseline human health risk assessment.

5. Toxicity Assessment (**Section 6.6**)

This section presents oral, inhalation, and dermal toxicity values used in the human health risk calculations. The USEPA recommended human health toxicity value hierarchy was used to identify toxicity values for this baseline risk assessment.

6. Risk Characterization (**Section 6.7**)

This section presents the risk calculations for all human health exposure pathways for the current and future land use scenarios. Non-carcinogenic and carcinogenic risk estimates are summarized for each receptor and exposure pathway.

7. Uncertainty Analysis (**Section 6.8**)

This section discusses uncertainty associated with the baseline human health risk assessment. The uncertainty associated with key variables and major assumptions used in the four major steps (site characterization and data evaluation, exposure assessment, toxicity assessment, and risk characterization) of the risk assessment are discussed to address their potential impacts on the results of the baseline human health risk assessment.

8. COC Identification (**Section 6.9**)

A further evaluation of COPCs contributing to elevated potential risks, if any, based on the risk characterization is presented in this section. Final contaminants of concern (COCs) identified for the sites are presented in this section.

9. Comparison of Chemicals Detected in Site Samples to ARARs and TBCs (**Section 6.10**)

A comparison of chemicals detected at the sites to the identified Applicable or Relevant and Appropriate Requirements and To Be Considered was conducted and presented in this section.

10. SEAD-59 Stockpiles Risk Assessment for Residential Receptors (**Section 6.11**)

This section presents potential risks posed by the SEAD-59 stockpiles to future receptors under a future residential scenario.

11. Summary and Conclusions (**Section 6.12**)

This section summarizes overall findings based on the baseline human health risk assessment.

6.2 CONCEPTUAL SITE MODEL

Potential sources of contamination, exposure pathways, and receptors are depicted in the CSM presented in **Figure 6-1**. The CSM provides an overall assessment of the primary and secondary sources of contamination at the sites, and the corresponding release mechanisms and affected media. The CSM also identifies the potential human receptors and the associated pathways of exposure to the affected media. The CSM is further discussed below.

6.2.1 Sources, Release Mechanisms, and Affected Media

The contaminant source areas, release mechanisms, and affected media for each site are discussed in **Sections 1** and **4** of the report and are summarized below:

SEAD-59

The contaminant sources at SEAD-59 are the construction debris and drums comprising the fill area and the debris and paint cans found elsewhere on the site. It should be noted that the source areas (i.e., the fill area and other areas where debris and paint cans have been located) were excavated during the 2002 TCRA by ENSR (2002a,b). The primary release mechanisms from the site include soil particles resuspension and deposition, surface water runoff, and the infiltration of precipitation through the source areas.

Potentially affected media at the site are soil (including stockpile soils produced during the 2002 TCRA) and groundwater.

SEAD-71

The contaminant sources at SEAD-71 are waste materials that were disposed of onsite. The primary release mechanisms from the site are soil particles resuspension and deposition, surface water runoff, which makes its way onto the areas to the southwest, and infiltration of precipitation through the potential source areas. It should be noted that the source areas (i.e., the waste material disposal area) were excavated during the 2002 TCRA by ENSR (2002a,b).

Potentially affected media at the site include soil and groundwater.

6.2.2 Fate and Transport

The environmental fate and transport associated with the general classes of chemicals found at SEAD-59 and SEAD-71 is presented in **Section 5** and is discussed briefly below.

Volatile Organic Compounds

Volatile organic compounds were detected infrequently in soil and groundwater at SEAD-59 and SEAD-71 and the concentrations are generally below the identified ARARs and TBCs (i.e., the NYSDEC TAGM values for soil; and the NYSDEC GA Standards and Guidance, the Drinking Water MCLs, and the USEPA Secondary Drinking Water Standards for groundwater). Because of the low prevalence and low concentrations, the sites are not significantly impacted by VOCs and volatilization of VOCs was not considered significant in this assessment.

Semi-Volatile Organic Compounds

The principal semi-volatile compounds found in SEAD-59 and SEAD-71 soil are polynuclear aromatic hydrocarbons (PAHs). Generally, these constituents are relatively persistent and immobile in the environment. Transport of PAHs is limited due to their low water solubility and strong soil affinity. TCLP analysis was conducted for SVOCs for several samples collected during the 2002 TCRA and the results were all nondetects (**Table A-10A/B in Appendix A**). Therefore leaching of SVOCs to groundwater is not expected to be a significant transport mechanism at the sites. Few SVOCs (4-nitroaniline, di-n-butylphthalate, and bis(2-ethylhexyl)phthalate) were detected in the groundwater infrequently. Groundwater at the sites is not expected to be impacted by SVOCs.

Pesticides/PCBs

Pesticides and one PCB, Aroclor-1260, were found in soil from both sites. Pesticides are immobile in soil as their affinity for absorption into the soil reduces the transport potential of pesticides. Low concentrations of pesticides can dissolve into water but absorption to soil is the dominant partitioning route. Transport of suspended solids and sediment in groundwater is a potential transportation mechanism but groundwater flow through the sites is low based on field notes from 2004 sampling events, thus reducing the rate of groundwater transport. Three pesticides were detected but no PCBs were detected in groundwater in the 2004 sampling events.

Metals

Multiple metals were found in groundwater and soil at SEAD-59 and SEAD-71. The behavior of metals in soil is unlike organic compounds in many aspects. For example, generally, volatilization from soil is not considered a significant mechanism for metal migration and was not evaluated in this risk assessment. However, leaching and sorption are considered potential mechanisms for transport. Leaching of metals from soil is controlled by numerous factors, the most important being its chemical form (base metal or cation) in the soil. The leaching of metals from soils is substantial if the metal exists as a soluble salt. Upon contact with surface water or precipitation, the metals, either as metal oxides or metal salts, can be solubilized, eventually leaching to the groundwater. TCLP analyses

were performed for some samples collected during the 2002 TCRA. A summary of the TCLP analysis results along with the organic and inorganic analysis results is presented in **Table A-10A/B** in **Appendix A**. Leaching is not expected to be a significant transport mechanism at SEAD-59/71 based on these TCLP results. Soil samples from both sites had exceedances of NYSDEC TAGM values for most metals. Groundwater samples from both sites had exceedances of the identified ARARs or TBCs for the following metals: aluminum, antimony, iron, manganese, and sodium.

6.2.3 Physical Setting and Characteristics

The physical setting and characteristics of the sites are described in **Section 1** of this report and are discussed briefly below. SEAD-59 and SEAD-71 are located in the east-central portion of the SEDA facility near the rounded top of a geologic formation separating two of the Finger Lakes. Glacial till varying in depth from a few feet to as much as 20 feet is the predominant geological unit at the sites and SEDA. Bedrock underlies the glacial till at SEDA. Groundwater is typically less than 10 feet below ground surface at the sites and groundwater flow is generally to the west to south-west.

SEAD-59 (Fill Area West of Building 135) is comprised of two pieces, one area located north of the access road to Building 311 and one area located to the south of the road. The area north of the access road was excavated during the 2002 TCRA. The area currently is gently sloped to the northwest with a relief of approximately 5 feet. The area south of the access road had several locations with soil excavated and the area slopes to the west towards a drainage ditch. The excavated areas were backfilled with soil excavated from the sites but demonstrated to be clean. Several drainage ditches are located at the site. These drainage ditches are dry most of the time.

SEAD-71 (the Alleged Paint Disposal Area) includes a chain-linked fenced storage area (see **Figure 2-10**) and the area west of the Fenced Area bounded by railroad tracks to the north and south. The area west of the Fenced Area was excavated during the TCRA conducted in 2002. The excavated areas were backfilled with soil excavated from the sites but demonstrated to be clean. The Fenced Area, surrounded by a chain-linked fence, has a paved/crushed stone and asphalt ground cover.

6.2.4 Land Use and Potentially Exposed Populations

The SEDA facility is in the Base Realignment and Closure process and transferring properties to be re-developed or made into conservation land. As part of the BRAC process, current and future land use of areas within SEDA were established and updated as needed. This section discusses the current and future land use of SEAD-59 and SEAD-71.

6.2.4.1 Current Land Use

Military presence at SEDA ended in July of 2000 and the sites under consideration are abandoned and no longer in use (Parsons, 2002a, b, c). These sites have no actual site workers and are occasionally

patrolled by site security personnel. No drinking water supply wells exist at either site or any other sites at SEDA, and connections to a public water supply system exist throughout SEDA (Parsons, 2004).

6.2.4.2 Potential Future Land Use

In July 1995, the BRAC Commission voted to recommend closure of SEDA. Congress approved the recommendation, which became public law on October 1, 1995. According to BRAC regulations, future uses of the site will be determined by the Army.

In accordance with BRAC regulations, the Army will notify all appropriate regulatory agencies and will perform any additional investigations and remedial actions to assure that any changes in the intended use of the sites is protective of human health and the environment in accordance with Comprehensive Environmental Response, Compensation, and Liability Act. As part of the 1995 BRAC process, a Land Redevelopment Authority comprised of representatives of the local public was established. This group commissioned a study to recommend future uses of the Seneca Army Depot. The Land Reuse Plan produced by the LRA designated various uses for different parcels of SEDA. This Land Reuse Plan is the basis of future land use assumptions for the sites included in this risk assessment. **Figure 1-11** shows the intended future land use of each parcel of SEDA. As shown in **Figure 1-11**, SEAD-59 and SEAD-71 are located in the Planned Industrial Development parcel. That is, the planned future land use for SEAD-59 and SEAD-71 is industrial development.

The Army intends to place institutional controls in the form of land use restrictions on the PID parcels. As described in the Signed Final Record of Decision for Sites Requiring Institutional Controls in the Planned Industrial/Office Development or Warehousing Areas (signed on September 28, 2004 by USEPA), the Army intends to impose the following restrictions:

- *Prohibit the development and use of property for residential housing, elementary and secondary schools, childcare facilities and playgrounds.*
- *Prevent access to or use of groundwater until the Class GA Groundwater Standards are met.*

Several sites within PID Area, including SEAD-59 and SEAD-71 are subject to ongoing investigations and remediation, and will be retained by the Army pending completion of the CERCLA process.

The intended PID area-wide land use restrictions on all areas within the bounded PID Area are based on the recorded findings for SEAD-27, SEAD-64A, and SEAD-66.

6.2.4.3 Potentially Exposed Populations

Potentially exposed populations that are relevant to the current and foreseeable future land use have been identified in this risk assessment as follows:

- Current and Future Construction Worker
- Future Industrial Worker
- Current Child Trespasser/Future Child Visitor

Current and Future Construction Worker

Construction workers had worked at the sites (e.g., during the time-critical removal action conducted in 2002) and will potentially be involved in site construction work in the future. The workers are expected to be exposed to contaminants in soil via ingestion, dermal contact, and inhalation of particulates generated from contaminated soils. In addition, exposure to contaminants in groundwater may occur as a result of groundwater intake and dermal contact.

Future Industrial Worker

SEAD-59 and SEAD-71 are located within the PID parcel and therefore the planned future use of the sites is industrial. The future industrial worker is a potential receptor at the sites and may be exposed to contaminants in soil via ingestion, dermal contact, and inhalation of particulates generated from soils. In addition, exposure to contaminants in groundwater may occur as a result of groundwater intake.

Current Child Trespasser/Future Child Visitor

Future child visitors are selected as a potential receptor as children are generally considered as sensitive receptors. Child visitors are assumed to visit the sites and potentially be exposed to contaminants in soil and groundwater. As children are regarded as a sensitive population for risk assessment, the child trespasser receptor can be used as a surrogate for other trespassers such as adolescent trespassers.

The Seneca Army Depot is fenced to limit access and is occasionally patrolled by site security personnel. Therefore, it is unlikely for anyone to trespass the sites. As a conservative measure, the future child visitor is used as a surrogate for child trespassers. This current child trespasser/future child visitor is hereafter referred to as the "Child Trespasser".

As discussed in **Section 6.2.4.2**, the Army recommends to prohibit the development and use of PID areas for residential housing, elementary and secondary schools, childcare facilities and playgrounds for the whole PID areas. This recommendation is recorded in the signed Final Record of Decision for Sites Requiring Institutional Controls in the Planned Industrial/Office Development or Warehousing Areas (signed on September 28, 2004 by USEPA). As a result, receptors such as future residents or day-care children were not evaluated in this risk assessment.

6.2.5 Identification of Exposure Pathways

Exposures were estimated only for plausible complete exposure pathways. According to USEPA (1989), a pathway is complete if there is:

- a source or chemical release from a source;
- an exposure point where contact can occur; and
- an exposure route by which contact can occur.

A pathway is not complete unless each of these elements is present. **Table 6-1** illustrates the selection of exposure pathways for the sites.

The pathways presented reflect the current and projected future site use of SEAD-59 and SEAD-71. This section presents the rationale for including these exposure pathways in this risk assessment.

Inhalation of Particulate Matter in Ambient Air

Surface soil (0-2 ft bgs.) particles may become airborne via wind erosion and/or site activities, which in turn may be inhaled by potential receptors at the sites. Therefore, inhalation exposure to soil particulates in ambient air was assessed for all receptors. Construction workers may be exposed to subsurface soil (2-15 ft bgs.) particles in addition to surface soil (0-2 ft bgs.) particles.

Incidental Ingestion and Dermal Contact to On-Site Soils

All receptors could come into contact with site surface soils (0-2 ft bgs.) and involuntarily ingest and have their skin exposed to site surface soils during the course of daily activities. Therefore, exposure via dermal contact and soil ingestion was assessed for all receptors. An on-site construction worker may come into contact with surface (0-2 ft bgs.) and subsurface (2-15 ft bgs.) soils during intrusive activities and may involuntarily ingest and have his/her skin exposed to surface and subsurface soils.

Groundwater Intake

Groundwater is not currently used as a potable water source at the Depot. Two private groundwater supply wells are approximately one mile to the south-east of the sites (**Figure 1-14**). However, the two private wells are located on the east sloping side of the watershed divide while the sites are located on the west slope of the watershed divide (**Figure 1-5**). The future plan for all areas of SEDA is to obtain potable water from the existing water supply line. Potable water is supplied to the Depot from a water supply line that passes through the Town of Varick. Varick's water is obtained from the water treatment plant at the Town of Waterloo. The source of this water is Lake Seneca. It is unlikely that a groundwater well would be installed for future drinking water use since a potable water pipeline exists. The shallow groundwater aquifer at the sites is inadequate for either yield or

quality. In addition, the Army recommends that future land use at the PID areas should “*Prevent access to or use of groundwater until the Class GA Groundwater Standards are met*” (Final Record of Decision for Sites Requiring Institutional Controls in the Planned Industrial/Office Development or Warehousing Areas, signed on September 28, 2004 by USEPA). Nonetheless, to evaluate potential risk posed by groundwater, it was assumed that wells would be installed on-site for potable water at the sites. Therefore, this is considered a complete pathway for all receptors at the sites.

Dermal Contact with On-Site Groundwater

Groundwater at SEAD-59 and SEAD-71 generally is between 5 ft and 10 ft bgs. Construction workers may be exposed to groundwater via dermal contact while working at the sites (e.g., digging trenches). Therefore, exposure via dermal contact with groundwater was evaluated for construction workers. Dermal contact with groundwater by industrial worker or child trespasser was considered unlikely and therefore not included in the risk assessment.

6.3 DATA EVALUATION

This section summarizes data used for this baseline human health risk assessment. A discussion of the data validation and data quality evaluation is presented in **Section 3**.

6.3.1 Data Used in Risk Assessment

Site soil and groundwater sampling have been completed at SEAD-59 and SEAD-71 for the purpose of developing data necessary to perform the human health and ecological risk assessments. All available soil and groundwater data were evaluated and data representative of the current site conditions were used in the baseline human health risk assessment and the screening level ecological risk assessment. Details of identifying the SEAD-59 and SEAD-71 data sets representative of the current site conditions can be found in **Section 3**. In summary, the following data were used for the human health risk assessment and ecological risk assessment:

- Groundwater collected during the 1994 Expanded Site Inspection by Parsons (Parsons, 1995, 1996) and groundwater data collected during the two rounds of monitoring in 2004.
- Soil data collected during the 1994 Expanded Site Inspection by Parsons (Parsons, 1995, 1996) that represent the current site conditions;
- Soil data collected during the 1997 Phase I Remedial Investigation by Parsons (Parsons, 2002a) that represent the current site conditions; and
- Confirmatory soil data and stockpile soil data collected during the 2002 TCRA (ENSR, 2002a) that represent the current site conditions.

All groundwater data were used in the risk assessment. Low-flow sampling method was not used for groundwater collected in 1994; therefore the 1994 groundwater data might be overstated by elevated turbidity. However, as a conservative (i.e., health protective) approach, all groundwater data were included in the risk assessment. For soil, three data sets were used for the baseline human health risk assessment and the screening-level ecological risk assessment: (1) SEAD-59 data, (2) SEAD-71 data, and (3) data from the stockpiles that remain at SEAD-59. EPCs were calculated for each data set and risks associated with each data set were evaluated for all identified receptors. The following subsections provide discussion of each data set used in the risk assessment.

The data used in the risk assessment are presented in **Appendix A, Tables A-1 through A-6**.

6.3.2 Background Data

Background soil samples and groundwater samples were compiled for this RI. Only inorganic constituents have been evaluated. Anthropogenic organic constituents have not been considered. Background soil and groundwater samples from the SEAD 25 RI, 25 ESIs, the Ash Landfill, and the Open Burn (OB) Grounds site have been combined into the background database. This was done so that the statistical evaluation of the data would be representative of the variations in the site soil and groundwater. Geologically, the soil material is identical throughout SEDA, having been deposited from the same source. This fact justifies combining the background soil and groundwater chemical composition data from all SEDA background locations into a single database.

Groundwater samples collected prior to implementing the USEPA's low-flow purging and pumping draft SOP, samples with high Nephelometric turbidity units (greater than 50 NTU), had elevated concentrations of inorganic elements. The high reported concentrations were due to the high amount of suspended particulates in the groundwater samples. Several locations were re-sampled using the draft USEPA low flow purging and pumping protocols where high NTU groundwater samples had been collected in the past. The results from these locations showed that the concentrations of dissolved inorganic elements in the low NTU samples were greatly reduced when compared to the reported concentrations in those samples with high NTUs. Therefore, the results from the high NTU samples may overstate the true dissolved inorganic element concentrations in the background groundwater.

The background data are presented in **Appendix B** and the summary statistics is presented in **Tables 6-2 A/B/C** and **6-3 A/B**.

6.3.3 Data Usability Evaluation

A summary of the data validation and the quality and other parameters pertinent to the data's acceptability for the risk assessment analysis are presented in **Section 3**. In brief, all data used in the risk assessment have been validated and qualified by Parsons chemist under the guidelines set forth in

the USEPA Contract Laboratory Program National Functional Guidelines, the Region 2 Resource Conservation and Recovery Act and CERCLA Data Validation Standard Operating Procedures, New York State Department of Environmental Conservation Contract Laboratory Program Analytical Services Protocol (ASP), and United States Army Corps of Engineers Shell for Analytical Chemistry Requirements (EM200-1-3), with consideration for the methodology requirements and the site-specific Quality Assurance Project Plan. The data were qualified during the data validation process. Rejected (“R” qualified) data were excluded from the risk assessment and all the other validated data were included in the risk assessment data sets. If a chemical was detected at least once in a specific medium at the sites, surrogate values for any nondetects (“U” or “UJ” qualified results) for that analyte were included in the risk assessment data sets at one-half the associated reporting limits.

6.3.4 Soil Sample Depth Identification

Potential source areas at SEAD-59 and SEAD-71 were excavated and backfilled during the 2002 TCRA and therefore the topography of the sites changed after the 2002 TCRA. The change of the topography resulted in a change of vertical depth of the soil samples collected within the excavation areas during the Expanded Site Inspection (Parsons, 1995, 1996) and Phase I RI (Parsons, 2002a). The depth of these soil samples was re-designated and **Tables 3-2A** and **3-2B** summarize the evaluation process. The SEAD-59 surface and subsurface soil results are presented in **Appendix A Table A-2A** and **Table A-2B**, respectively. The SEAD-71 surface and subsurface soil results are presented in **Appendix A Table A-4A** and **Table A-4B**, respectively.

Based on the re-designated depth of the ESI and Phase I samples, the soil data were categorized as surface (0-2 ft bgs.) and subsurface (2-15 ft bgs.). All confirmatory data, backfill data, and stockpile data from the TCRA were assumed as surface soil data. For cases where a clear-cut decision could not be made, a conservative approach was used (i.e., soil near 2 ft bgs. was designated as surface soil; similarly, soil near 15 ft bgs. was designated as subsurface soil).

6.3.5 Protocol for Using Field Duplicate Results

Protocol for using field duplicate results is presented in **Section 3**. In brief, the sample and its field duplicate were treated as one entry and the average concentration of the sample and its field duplicate was used to represent the concentration at the sample location.

6.4 IDENTIFICATION OF CHEMICALS OF POTENTIAL CONCERN

Human health chemicals of potential concern were selected based on the screening process described below.

1. The maximum detected concentration of each chemical detected in all soil samples (i.e., including surface soil, subsurface soil, and deep soil samples) was compared to the USEPA

Region 9 preliminary remediation goals (PRGs) for residential soil and other appropriate USEPA screening values if Region 9 PRGs are not available (e.g., USEPA Region III Risk-Based Concentrations for residential soil). The PRG for residential soil or other screening value was selected and determined at a risk level of 1×10^{-6} (for carcinogens) or hazard quotient level of 1 (for noncarcinogens), whichever is lower.

Chemicals were eliminated as COPCs in soil for human exposure if the maximum detected concentration was less than the screening level or if there was no screening level available. A chemical was considered to be a COPC in soil if the maximum detected concentration was greater than the screening level. For closely related chemicals (structure and mode of toxicity), screening criteria for surrogate chemicals were used.

2. The maximum detected concentration of each chemical detected in SEAD-59 stockpile samples was compared to the USEPA Region 9 PRGs for residential soil and other appropriate screening values to identify COPCs in stockpile soil.
3. The maximum detected concentration of each chemical detected in groundwater was compared to the Region 9 PRGs for tap water determined for a risk level of 1×10^{-6} (for carcinogens) or hazard quotient level of 1 (for noncarcinogens). Other appropriate USEPA screening values were used if Region 9 PRGs are not available (e.g., USEPA Region III Risk-Based Concentrations for tap water, USEPA Maximum Contaminant Level for drinking water). Chemicals were eliminated as COPCs for human exposure if concentrations were less than the screening level or if there was no screening value available. A chemical was considered to be a COPC if the maximum detected concentration was greater than the screening value.
4. Essential nutrients were eliminated as COPCs in all media, if applicable. Essential nutrients include calcium, magnesium, sodium, and potassium. The recommended dietary allowances and adequate intakes by Wright (2001) and other resources were evaluated to determine whether the concentration is within the recommended daily requirements for essential nutrients.
5. An evaluation was made to determine whether any previously eliminated chemical or medium should be included due to other considerations (e.g., potential break-down products, nondetected chemicals with reporting limits above health-based levels). In addition, any member of a chemical class that has other members selected as COPCs was retained (e.g., all detected carcinogenic polynuclear aromatic hydrocarbons were retained as COPCs if one was identified as a COPC based on the screening process).
6. For each medium, a determination was made as to whether there were any COPCs remaining. If no COPCs remain, the medium was dropped from further consideration in the risk assessment.

Results of the above screening process for soil are summarized in **Tables 6-2A, 6-2B, and 6-2C** for SEAD-59, SEAD-71, and SEAD-59 stockpile soil, respectively. Results of the above screening process for groundwater are summarized in **Tables 6-3A and 6-3B** for SEAD-59 and SEAD-71, respectively. Constituents identified as human health COPCs include SVOCs (mainly PAHs), pesticides, and inorganics in soil and one SVOC (4-nitroaniline) and several inorganics in groundwater. The COPCs identified were quantitatively and/or qualitatively evaluated in the Human Health Risk Assessment (HHRA).

6.5 EXPOSURE ASSESSMENT

The objective of the exposure assessment was to estimate the type and magnitude of exposures to the COPC that are present at, or migrating from, the site. The exposure assessment consists of three steps (USEPA, 1989):

1. **Characterize Exposure Setting:** In this step, information on the physical characteristics of the site that may influence exposure is considered. The physical setting involves climate, vegetation, soil characteristics, surface and groundwater hydrology. All potentially exposed populations and sub-populations therein (receptors) are assessed relative to their potential for exposure. Additionally, locations relative to the site along with the current and potential future land use of the site are considered. This step is a qualitative one aimed at providing a general site perspective and offering insight on the surrounding population.
2. **Identify Exposure Pathways:** All exposure pathways, ways in which receptors can be exposed to contaminants that originate from the source, are reviewed in this step. Chemical sources and mechanisms for release along with subsequent fate and transport are investigated. Exposure points of human contact and exposure routes are discussed before quantifying the exposure pathways in step 3.
3. **Quantify Exposure:** In this final step, the exposure levels (COPC intakes or doses) are calculated for each exposure pathway and receptor. These calculations typically follow USEPA guidance for assumptions of intake variables or exposure factors for each exposure pathway and USEPA-recommended calculation methods.

Section 1 of this report presents the physical setting of the sites. The exposure pathways are presented in **Section 6.2.5**. This section presents the three key factors involved in the exposure quantification process: exposure point concentrations (**Section 6.5.1**), exposure factor assumption (**Section 6.5.2**), and exposure quantification (**Section 6.5.3**).

6.5.1 Derivation of Exposure Point Concentrations

After identifying COPCs for the risk assessment, exposure point concentrations were calculated for each of the COPCs in each medium at the two sites. Two types of exposure were estimated for the baseline human health risk assessment: a reasonable maximum exposure (RME) and a central tendency exposure (CT). The RME is defined as the highest exposure that could reasonably be expected to occur for a given exposure pathway at a site, and is intended to account for both uncertainty in the contaminant concentration and variability in the exposure parameters (such as exposure frequency or averaging time). The CT may be evaluated for comparison purposes and is generally based on more realistic mean exposure parameters. Both scenarios have been evaluated in this risk assessment. The EPCs were set as the same for the RME and CT scenarios.

6.5.1.1 Soil EPC

Soil EPCs were calculated for two exposure points: 1) surface soil (0-2 ft bgs.); 2) surface soil and subsurface soil (0-15 ft bgs.). Industrial workers and child trespassers were assumed to be exposed to surface soil (0-2 ft bgs.) while construction workers were assumed to be exposed to surface and subsurface soil (0-15 ft bgs.) during excavation activities.

Soil EPCs for the reasonable maximum exposure and central tendency risk calculations are equal to an appropriate upper confidence limit (UCL) of the arithmetic mean of the concentrations (USEPA, 2004c). The EPC, or the appropriate UCL of the mean concentration, was calculated using the USEPA Software for Calculating Upper Confidence Limits (ProUCL version 3.00.02). The EPC calculation is consistent with the USEPA guidance (2002b). The algorithms and procedures were described in the USEPA (2002b) Calculating Upper Confidence Limits For Exposure Point Concentrations At Hazardous Waste Sites and USEPA (2004c) ProUCL Version 3.0 User Guide. In brief, the following algorithms were used for calculating the soil EPCs for SEAD-59 and SEAD-71 risk assessment:

1. Sample and its field duplicate were averaged and treated as a single entry.
2. Half reporting limits were used to represent concentrations for non-detects.
3. USEPA's ProUCL Version 3.0 was used to generate an appropriate UCL to be used as the EPC. The USEPA ProUCL provides summary results for normal distribution test, lognormal distribution test, and gamma distribution test of the data. Based upon an appropriate data distribution and the associated skewness, ProUCL provides recommendations about an appropriate UCL computation method that may be used to estimate the unknown mean concentration of a COPC.

For lead, the arithmetic mean of each data set was used as the EPC, which is consistent with the USEPA (1994) guidance.

Tables 6-4A, 6-4B, and 6-4C summarize surface soil EPCs for SEAD-59, SEAD-71, and SEAD-59 stockpile soil, respectively. **Tables 6-5A and 6-5B** summarize EPCs for surface and subsurface soil at SEAD-59 and SEAD-71, respectively.

6.5.1.2 Groundwater EPC

Future use of groundwater has been based on the assumption that a single private well can be placed anywhere in the contaminated plume, if any. Therefore, as a conservative step, the maximum detected concentration of each COPC at each site across several rounds of monitoring was used as the EPC for groundwater as a conservative step for both the reasonable maximum exposure and central tendency scenarios. Sample and its field duplicate were averaged and treated as a single entry.

Tables 6-6A and 6-6B summarize groundwater EPCs at SEAD-59 and SEAD-71, respectively.

6.5.1.3 Ambient Air EPC

EPCs for COPCs in ambient air were estimated based on the soil EPCs and the concentrations of particulate matter less than 10 μ m aerodynamic diameter (PM₁₀) in ambient air. Industrial workers and child trespassers were assumed to be exposed to surface soil and dust caused by surface soil. Construction workers were assumed to be exposed to surface and subsurface soil and associated dust. Therefore, both ambient air EPCs caused by surface soil (0-2 ft bgs.) and ambient air EPCs caused by surface and subsurface soil (0-15 ft bgs.) were calculated. The former was used to evaluate risks for industrial workers and child trespassers, and the latter was used to evaluate risks for construction workers. A detailed discussion of PM₁₀ concentration evaluation is presented in **Section 6.5.3**.

Tables 6-7A, 6-7B, and 6-7C summarize ambient air EPCs caused by dust from surface soil at SEAD-59, SEAD-71, and SEAD-59 stockpile soil, respectively. **Tables 6-8A and 6-8B** summarize ambient air EPCs caused by dust from surface and subsurface soil at SEAD-59 and SEAD-71, respectively.

6.5.2 Exposure Factor Assumptions

An important aspect of exposure assessment is the determination of assumptions regarding how receptors may be exposed to contaminants. An extensive listing of exposure factors are provided in USEPA guidance, and these were followed throughout this assessment. Standard scenarios and USEPA-recommended default assumptions were used where appropriate.

The exposure scenarios in this assessment involve the following receptors, based on the current land use and future use for Planned Industrial Development:

- current/future construction worker
- future industrial worker
- current child trespasser/future child visitor (referred to as child trespasser)

The exposure assumptions for these scenarios are intended to approximate the frequency, duration, and manner in which receptors are exposed to environmental media. For example, the worker scenarios are intended to approximate the exposure potential of individuals employed at the sites.

Exposure assumptions and parameters were identified for both the Reasonable Maximum Exposure and Central Tendency exposure scenarios based on the following USEPA guidance and conservative professional judgment, if USEPA guidance is not available.

- USEPA, 1991: Supplemental Guidance, Standard Default Exposure Factors
- USEPA, 1997a: Exposure Factors Handbook
- USEPA, 2002a: Supplemental Guidance For Developing Soil Screening Levels For Superfund Sites. December
- USEPA, 2004a: Risk Assessment Guidance for Superfund Volume I: Human Health Evaluation Manual (Part E, Supplemental Guidance for Dermal Risk Assessment)

Details of the exposure assumptions and parameters for each exposure scenario are shown in **Tables 6-9A, 6-9B, and 6-9C** for the construction worker, industrial worker, and child trespasser, respectively. A brief summary of selected exposure factor assumptions are presented below for each receptor.

Construction Worker. Construction workers were assumed to spend one year working at the sites, which is a typical duration for a significant construction project. These workers spend 5 days/week for 50 weeks (i.e., 250 days, RME scenario) or 219 days (CT scenario) at the sites. During each working day, construction workers inhale the ambient air at the sites and may ingest or dermally contact the surface and subsurface soil (0-15 ft bgs.). Construction workers were assumed to contact groundwater by their hands and forearms one event each day during 100 workdays (i.e., one day at the beginning of the week and one day at the end of the week for 50 weeks) to assemble or disassemble a pumping system. Each event is assumed to last half an hour. Future construction workers were assumed to intake groundwater 1 L/day (RME) or 0.7 L/day (CT) from the site during each workday.

Industrial Worker. The future industrial workers were assumed to spend 5 days/week for 50 weeks (i.e., 250 days, RME scenario) or 219 days (CT scenario) each year at the sites. This exposure period lasts for an entire 25-year (RME scenario) or 9-year (CT scenario) career. During each workday at the sites, these workers inhale the ambient air, intake groundwater, and ingest and dermally contact surface soil (0-2 ft bgs.).

Child Trespasser/Visitor. Child trespassers were assumed to spend 14 days a year for 6 years (ages 0-6 yr) at the sites. During each visit at the sites, the children inhale the ambient air, and ingest and dermally contact surface soil (0-2 ft bgs.). Child trespassers were assumed to intake groundwater 1.5 L/day (RME) or 0.7 L/day (CT) from the site during each visit.

6.5.3 Quantification of Exposure

Once the EPCs were calculated, each receptor's potential exposures to chemicals of potential concern is quantified for each of the exposure pathways. The exposures were calculated following methods recommended in USEPA guidance documents, such as the RAGS (USEPA, 1989). A human health intake or the absorbed dose, depending on the exposure route, was calculated based on the EPC and exposure factor assumptions. Intakes or doses are normally expressed as the amount of chemical at the environment-human receptor exchange boundary in milligrams per kilogram of body weight per day (mg/kg-day), which represents an exposure normalized for body weight over time. The total exposure is divided by the period of interest to obtain an average exposure. The averaging time is a function of the toxic endpoint: for non-carcinogenic effects, it is the exposure time (specific to the scenario being assessed) and for carcinogenic effects, it is lifetime (70 years).

The generic equation used to calculate intake for receptors is as follows (adapted from USEPA 1989):

$$DI = \frac{EPC \times CR \times B \times EFD}{BW \times AT}$$

Where:

- DI = Daily intake; the amount of chemical at the exchange boundary (mg/kg body weight-day);
- EPC = Exposure point concentration (e.g., mg/L or mg/kg);
- CR = Contact rate; the amount of contaminated medium contacted per unit time or event (e.g., L/d or mg/d);
- B = Relative Bioavailability, the relative oral absorption fraction (unitless);
- EFD = Exposure frequency and duration; describes how long and how often exposure occurs. Often calculated using two terms (EF and ED):
- EF = Exposure frequency (d/y) and ED = Exposure duration (y);
- BW = Body weight (kg); and
- AT = Averaging time; period over which exposure is averaged (d).

In this section, the methods used to calculate exposures by each pathway are explained. Tables that show the human intake or absorbed dose values calculated for each exposure scenario at each site are contained in **Appendices C, D, and E**. These intakes and doses were used to assess overall

carcinogenic and non-carcinogenic risks, as discussed later in the risk characterization section (**Section 6.6**).

6.5.3.1 Inhalation of Particulate Matter in Ambient Air

The equation for inhalation of particulate matter in ambient air is as follows (USEPA, 1989):

$$\text{Intake (mg/kg/day)} = \frac{\text{EPC}_{\text{air}} \times \text{IR} \times \text{EF} \times \text{ED}}{\text{BW} \times \text{AT}}$$

Where:

- EPC_{air} = Exposure Point Concentration in air (mg/m³)
- IR = Inhalation Rate (m³/day)
- EF = Exposure frequency (days/year)
- ED = Exposure duration (years)
- BW = Bodyweight (kg)
- AT = Averaging Time (days)

As discussed in **Section 6.5.1**, the EPC in air was calculated based on the soil EPC and PM₁₀ concentration. PM₁₀ represents smaller particles which can be inhaled (particles larger than 10µm diameter typically cannot enter the narrow airways in the lung). Ambient PM₁₀ concentrations for a construction worker were estimated using an emission and dispersion model. PM₁₀ concentrations for industrial workers and trespassers were based on existing site air measurements shown in **Table 6-10**.

Construction Worker

During construction activities, fugitive dusts may be generated from soil by wind erosion, construction vehicle traffic on temporary unpaved roads, excavation, and other construction activities. The dusts would contain the chemicals present in the soil. Construction workers in the construction area would breathe this PM in the ambient air and therefore may be exposed to chemicals in site soils via inhalation. As current and future subsurface activities (e.g., excavation) could bring subsurface soils to the surface, both surface and subsurface soil (0-15 ft bgs.) data were used to evaluate the EPC in air associated with the fugitive dust for construction workers. A model presented in the USEPA (2002a) Supplemental Guidance for Developing Soil Screening Levels for Superfund Sites, which evaluates the fugitive dust emission by truck traffic on unpaved roads during construction was used to estimate the EPC in ambient air during the construction. This model was selected as truck traffic on unpaved road is a common activity and occurs frequently at a construction site and therefore is considered a significant mechanism to cause dust. According to USEPA (2002a), *“emissions from truck traffic on unpaved roads, which typically contribute the majority of dust emissions during construction...”*. *“In the case of particulate matter, traffic on contaminated unpaved roads typically accounts for the majority of*

emissions, with wind erosion, excavation soil dumping, dozing, grading, and tilling operations contributing lesser emissions.” Based on the above discussion, the emissions from truck traffic on unpaved roads were modeled to represent PM₁₀ produced by the construction activity.

$$EPC_{air} = EPC_{soil} \times \frac{1}{PEF_{sc}}$$

Where:

EPC_{air} = Exposure Point Concentration of chemicals in air associated with fugitive dust (mg/m³);

EPC_{soil} = Exposure Point Concentration of chemicals in soil (mg/kg);

PEF_{sc} = Subchronic road particulate emission factor (m³/kg).

$$PEF_{sc} = Q/C_{sr} \times \frac{1}{F_D} \times \left[\frac{T \times A_R}{556 \times (W/3)^{0.4} \times \frac{365d/yr - p}{365d/yr} \times \sum VKT} \right]$$

Where:

Q/C_{sr} = Inverse of the ratio of the 1-h geometric mean air concentration to the emission flux along a straight road segment bisecting a square site (g/m²-s per kg/m³)

F_D = Dispersion correction factor (unitless), 0.185

T = Total time over which construction occurs (s)

A_R = Surface area of contaminated road segment (m²)

$$A_R = L_R \times W_R \times 0.092903 \text{ m}^2/\text{ft}^2$$

L_R = Length of road segment (ft), assumed 511 ft for SEAD-59/71

W_R = Width of road segment (ft), assumed 20 ft

W = Mean vehicle weight (tons)

p = Number of days with at least 0.01 inches of precipitation (days/year), 120 days/year based on Exhibit 5-2 of the USEPA (2002a) document

ΣVKT = Sum of fleet vehicle kilometers traveled during the exposure duration (km)

$$Q/C_{sr} = A \times \exp\left[\frac{(\ln A_s - B)}{C}\right]$$

Where:

A = Constant (unitless), 12.9351

A_s = Area extent of site surface soil contamination (acres), for SEAD-59 and SEAD-71, A_s was assumed to be 6 acres as a conservative estimate

B = Constant (unitless), 5.7383

C = Constant (unitless), 71.7711

Mean vehicle weight (W) can be estimated by assuming the numbers and weights of different types of vehicles. For SEAD-59 and SEAD-71, assuming that the daily unpaved road traffic consists of 20 two-ton cars and 10 twenty-ton trucks, the mean vehicle weight would be:

$$W = [(20cars \times 2tons / car) + (10trucks \times 20tons / truck)] / 30vehicles = 8tons$$

The sum of the fleet vehicle kilometers traveled during construction (ΣVKT) can be estimated based on the size of the area of soil contamination, assuming the configuration of the unpaved road, and the amount of vehicle traffic on the road. The area of soil contamination at SEAD-59 and SEAD-71 was assumed to be 6 acres (or 24,220 m²), the total SEAD-59 and SEAD-71 area. It was assumed that this area would be configured as a square with the unpaved road segment dividing the square evenly, the road length would be equal to the square root of 24,220 m², 155.6 m (or 0.1556 km, or 511 ft). Assuming that each vehicle travels the length of the road once per day, 5 days per week for a total of 6 months, the total fleet vehicle kilometers traveled would be:

$$\Sigma VKT = 30vehicles \times 0.1556km / day \times 50wks / yr \times 5days / wk = 1167km$$

The PM₁₀ concentration estimated for the construction scenario is 954 ug/m³ based on the above assumptions. The ambient air exposure point concentrations for construction workers are presented in **Tables 6-8A** and **6-8B** for SEAD-59 and SEAD-71, respectively.

Industrial Workers and Child Trespassers

Ambient air normally contains particulate matter derived from various natural and anthropogenic sources, including soil erosion, fuel burning, automobiles, etc. The PM₁₀ concentrations were measured at four locations in SEDA over a four-month period (April-July) in 1995. A summary of the data collected in this air sampling program is shown in **Table 6-10**.

For this assessment, the highest 4-month average PM₁₀ concentration measured at any of the four monitoring stations (16.9 ug/m³, rounded to 17 ug/m³) was assumed to represent ambient air at SEAD-59 and SEAD-71. The entire particulate loading was assumed to be airborne soil released from the site as represented by the surface soil EPCs for each site.

The concentration of particulate-associated chemicals in ambient air was calculated with the same equation used for the construction worker, above.

$$EPC_{air} = EPC_{soil} \times PM_{10} \times C$$

Where:

EPC_{air} = Exposure Point Concentration of chemicals in air associated with fugitive dust (mg/m³);

- EPC_{soil} = Exposure Point Concentration of chemicals in soil (mg/kg);
 PM_{10} = Concentration of particulate matter less than 10 μ m aerodynamic diameter in air (ug/m³);
 C = Conversion factor, 10⁻⁹ kg/ug.

The ambient air exposure point concentrations for industrial workers and child trespassers are presented in **Tables 6-7A, 6-7B, and 6-7C** for SEAD-59, SEAD-71, and SEAD-59 stockpile soil, respectively.

6.5.3.2 Incidental Ingestion of Soil

The equation for intake via incidental ingestion of soil is as follows (adapted from USEPA 1989):

$$\text{Intake (mg/kg-day)} = \frac{EPC_{soil} \times IR \times B \times CF \times FI \times EF \times ED}{BW \times AT}$$

Where:

- EPC_{soil} = Soil Exposure Point Concentration (mg/kg)
 IR = Soil Ingestion Rate (mg /day)
 B = Relative Bioavailability, the relative oral absorption fraction (unitless)
 CF = Conversion Factor (1 kg/10⁶ mg)
 FI = Fraction Ingested from Contaminated Source (unitless)
 EF = Exposure Frequency (days/years)
 ED = Exposure Duration (years)
 BW = Body Weight (kg)
 AT = Averaging Time (period over which exposure is averaged -- days)

To accurately quantify potential exposures from ingestion of soil, it is important to consider the amount of a chemical that is solubilized in gastrointestinal fluids and absorbed across the gastrointestinal tract into the bloodstream. A chemical present in soil may be absorbed less completely than the same dose of the chemical administered in toxicity studies used to evaluate safe dose levels. A relative bioavailability estimate for a specific compound represents the absorption fraction from soil (the exposure route of concern) relative to the absorption fraction from food or water (in most toxicity studies, chemical doses are administered in food or water).

It is widely recognized that bioavailability of many metals and organics from soil tends to be considerably lower than bioavailability from food or water (see, for example, Ruby *et al.*, 1999 and Alexander, 2000). Bioavailability from soil can be affected by a number of factors, including chemical form, solubility, size of the ingested soil particle, soil type, degree of encapsulation within an insoluble matrix, and nutritional status of the individual.

USEPA guidance recognizes the need to make adjustments for the reduced bioavailability of compounds in soil. Specifically, in Appendix A of EPA's Risk Assessment Guidance for Superfund (USEPA, 1989, pg. A-3), USEPA notes:

"If the medium of exposure in the site exposure assessment differs from the medium of exposure assumed by the toxicity value (e.g., RfD values usually are based on or have been adjusted to reflect exposure via drinking water, while the site medium of concern may be soil), an absorption adjustment may, on occasion, be appropriate. For example, a substance might be more completely absorbed following exposure to contaminated drinking water than following exposure to contaminated food or soil (e.g., if the substance does not desorb from soil in the gastrointestinal tract)."

The USEPA guidance goes on to recommend the use of relative absorption adjustments; for example, "to adjust a food or soil ingestion exposure estimate to match an RfD or slope factor based on the assumption of drinking water ingestion" (USEPA, 1989, pg. A-3).

A relative bioavailability of 0.29 was identified for PAHs for soil ingestion exposure pathway by Magee et al. (1996). The single oral-soil relative bioavailability for PAHs was derived from three studies with benzo(a)pyrene, a five-ring potentially carcinogenic PAH, and pyrene, a four-ring noncarcinogenic PAH. This oral-soil relative bioavailability was assumed for PAHs in this risk assessment. Uncertainty associated with this relative bioavailability is discussed in Section 6.8.2.

Although the general principles discussed above are likely to reduce the bioavailability of compounds in soil, published bioavailability studies of compounds have been limited. Therefore, a relative bioavailability of 100% was used in the risk assessment for ingestion of all other COPCs. This is a very conservative assumption. Specifically, the physical and chemical properties of a compound change over time. These changes, known as "weathering", can make a chemical less bioavailable to organisms, including mammals (e.g., humans) (Loehr, 1996).

6.5.3.3 Dermal Contact with Soil

The equation for the absorbed dose from dermal exposure is as follows, based on USEPA (2004a) guidance:

$$\text{Absorbed Dose (mg/kg-day)} = \frac{DA_{\text{event}} \times EF \times ED \times EV \times SA}{BW \times AT}$$

$$DA_{\text{event}} = EPC_{\text{soil}} \times CF \times AF \times ABS_d$$

Where:

DA_{event} = Absorbed dose per event (mg/cm²-event)

EF = Exposure frequency (days/year)

ED = Exposure duration (years)

EPC_{soil}	=	Exposure point concentration in soil (mg/kg)
EV	=	Event frequency (events/day)
SA	=	Skin surface area available for contact (cm ²)
BW	=	Body weight (kg)
AT	=	Averaging time (period over which exposure is averaged -- days)
CF	=	Conversion factor (10 ⁻⁶ kg/mg)
AF	=	Soil to skin adherence factor (mg/cm ² -event)
ABS_d	=	Dermal absorption factor (unitless)

6.5.3.4 Groundwater Intake

All receptors were assumed to intake groundwater from the sites. The equation for groundwater intake is as follows (USEPA, 1989):

$$\text{Intake (mg/kg-day)} = \frac{EPC_{gw} \times IR \times EF \times ED}{BW \times AT}$$

Where:

EPC_{gw}	=	Exposure point concentration in groundwater (mg/liter)
IR	=	Groundwater intake rate (liters/day)
EF	=	Exposure frequency (days/year)
ED	=	Exposure duration (years)
BW	=	Bodyweight (kg)
AT	=	Averaging time (days)

6.5.3.5 Dermal Contact with Groundwater

The construction worker may be exposed to groundwater while working at the sites. The equation for the absorbed dose, according to EPA (2004a) is as follows:

$$\text{Absorbed Dose (mg/Kg-day)} = \frac{DA_{event} \times EF \times ED \times EV \times SA}{BW \times AT}$$

Where:

DA_{event}	=	Absorbed dose per event (mg/cm ² - event)
EF	=	Exposure frequency (days/year)
ED	=	Exposure duration (years)
EV	=	Event frequency (events/day)
SA	=	Skin surface area available for contact (cm ²)
BW	=	Body weight (kg)
AT	=	Averaging time (period over which exposure is averaged -- days)

The absorbed dose per event (DA) was calculated as described in USEPA's Supplemental Guidance for Dermal Risk Assessment (USEPA, 2004a).

For organics, a parameter, B was first calculated. This value attempts to characterize the relative contribution of each compound's specific permeability coefficient (K_p value) in the stratum corneum and the viable epidermis.

$$B = K_p \frac{\sqrt{MW}}{2.6}$$

Where:

K_p = Dermal permeability coefficient in water (cm/hr)
 MW = Molecular weight (g/mole)

Once calculated, the B value was used to calculate time conditions associated with estimates of compound breakthrough time.

If $B \leq 0.6$, then $t^* = 2.4\tau_{event}$

If $B > 0.6$, then $t^* = 6\tau_{event} (b - \sqrt{b^2 - c^2})$

$$b = \frac{2(1+B)^2}{\pi} - c$$

$$c = \frac{1 + 3B + 3B^2}{3(1 + B)}$$

$$\tau_{event} = 0.105 \times 10^{(0.0056MW)}$$

Where:

B = Dimensionless ratio of the permeability coefficient of a compound through the stratum corneum relative to its permeability coefficient across the viable epidermis (dimensionless)
 t^* = Time to reach steady-state (hr)
 τ_{event} = Lag time per event (hr/event)
 b,c = Correlation coefficients which have been fitted to the Flynn's data

The lag time (τ_{event}), is defined as the time it takes a chemical to penetrate to reach a steady-state condition during a dermal exposure in aqueous media. By properly defining the lag time, the permeability coefficient can be more properly used in the risk calculation further reducing uncertainty. Lag time and breakthrough time (t^*) for each organic COPC were from Exhibit B.3 of

the USEPA (2004a) Supplemental Guidance for Dermal Risk Assessment, or calculated using the above USEPA recommended equations.

If the exposure time per event (t_{event}) is less than the breakthrough time (t^*) of steady-state conditions specific to each compound, then the absorbed dose is calculated as follows:

$$DA_{event} = 2FA \times K_p \times EPC_{gw} \times CF \times \sqrt{\frac{6\tau_{event} \times t_{event}}{\pi}}$$

If the exposure time is longer than t^* , then the absorbed dose is calculated using:

$$DA_{event} = FA \times K_p \times EPC_{gw} \times CF \times \left[\frac{t_{event}}{1+B} + 2\tau_{event} \left(\frac{1+3B+3B^2}{(1+B)^2} \right) \right]$$

Where for both equations:

- FA = Fraction absorbed water (dimensionless), assumed as 1
- K_p = Dermal permeability coefficient (cm/hr)
- EPC_{gw} = EPC Concentration in Water (mg/L)
- ET = Exposure Time (hours)
- CF = Volume Conversion Factor = 0.001L/cm³

For inorganics, DA was calculated by:

$$DA = K_p \times EPC_{gw} \times t_{event} \times CF$$

Dermal permeability coefficients for inorganic chemicals and a number of organic chemicals can be found in the USEPA (2004a) Supplemental Guidance for Dermal Risk Assessment. When no organic K_p value was available, a value was calculated using the following equation:

$$\log K_p = -2.80 + 0.66 (\log K_{ow}) - 0.0056 (MW)$$

Where:

- K_{ow} = Octanol/water partition coefficient of the non-ionized species (dimensionless)

6.5.3.6 Evaluation of Lead Exposure

Lead was considered to be a COPC in SEAD-71 soil, SEAD-59 stockpile soil, and SEAD-71 groundwater. For the industrial worker and construction worker, risk associated with lead was evaluated using the Recommendations of the Technical Review Workgroup for Lead for an Interim Approach to Assessing Risks Associated with Adult Exposures to Lead in Soil (USEPA, 2003d).

This adult lead model (ALM) provides an assessment of nonresidential exposure by relating soil lead intake to blood lead concentrations in women of childbearing age. Thus, while adult exposure is addressed by USEPA's analysis, the most sensitive receptor (i.e., the fetus) is being protected. The methodology focuses on estimating fetal blood lead levels in women exposed to site soils. The adult lead model was used to evaluate exposure to SEAD-71 and SEAD-59 stockpile soil for the construction worker and industrial worker.

For the child trespasser, the Integrated Exposure Uptake Biokinetic Model for Lead in Children (IEUBK) developed by USEPA was used to evaluate lead level in child via exposure to soil and groundwater. The IEUBK model results, based on residential exposure assumption, were used as a screening tool to evaluate potential risks for child trespasser. The IEUBK windows version software package was developed based on the USEPA (1994) IEUBK Guidance Manual. The model utilizes four interrelated modules (exposure, uptake, biokinetic, and probability distribution) to estimate blood lead (PbB) levels in children exposed to lead-contaminated media.

For both models, the site-specific EPCs and exposure factors were used along with the default assumptions presented in the models to derive the lead level estimation for the receptors. In accordance with the USEPA (2003d) guidance, the updated ranges of baseline PbB and individual geometric standard deviation (GSDi) based on the completed National Health and Nutrition Evaluation (NHANES) III survey (Phases 1 and 2) (USEPA, 2002e) were used in the adult lead model spreadsheet. The ingestion rate for central tendency exposure presented in **Table 6-9A** and **6-9B** was 0.1 g/day and 0.05 g/day for construction workers and industrial workers, respectively. These values were used for the ALM model.

6.6 TOXICITY ASSESSMENT

The objective of the toxicity assessment is to weigh available evidence regarding the potential of the chemicals to cause adverse effects in exposed individuals, and to provide, where possible, an estimate of the relationship between the extent of exposure to a chemical and the increased likelihood and/or severity of adverse effects. The types of toxicity information considered in this assessment include the reference dose (RfD) and reference concentration (RfC) used to evaluate non-carcinogenic effects, and the slope factor and unit risk to evaluate carcinogenic potential. The toxicity values for this risk assessment were selected in accordance with the USEPA recommended human health toxicity value hierarchy. In a memorandum issued to Superfund Regions 1-10 National Policy Managers in December 2003, the USEPA Office of Solid Waste and Emergency Response (OSWER) provided a revised recommended human health toxicity value hierarchy as follows:

- Tier 1 – USEPA's Integrated Risk Information System (IRIS)

- Tier 2 – USEPA’s Provisional Peer Reviewed Toxicity Values (PPRTVs) developed by the Office of Research and Development / National Center for Environmental Assessment (NCEA) / Superfund Health Risk Technical Support Center (STSC).
- Tier 3 – Other Toxicity Values from additional USEPA and non-EPA sources with priority given to those sources of information that are the most current, the basis for which is transparent and publicly available, and which have been peer reviewed.

For chemicals without toxicity values, it may be appropriate to generate a value by alternate methods. Such methods may include route-to-route extrapolation or use of toxicity values of chemicals that are related both chemically and toxicologically (e.g., evaluation of structure-activity relationships). For this assessment, no surrogate toxicity values were derived.

For the evaluation of carcinogenic PAHs, toxicity equivalency factors (TEFs) based on the toxicity of benzo(a)pyrene were used (USEPA 1993a). In brief, slope factors for carcinogenic PAHs without slope factors developed were calculated using TEFs. TEFs are values that compare the carcinogenic potential of a given chemical in a class to the carcinogenic potential of a chemical in the class that has a verified slope factor. USEPA has provided TEFs for PAHs (USEPA, 1993a). TEF values are as follows:

PAH	TEF
Benzo(a)pyrene	1.0
Benzo(a)anthracene	0.1
Benzo(b)fluoranthene	0.1
Benzo(k)fluoranthene	0.01
Dibenzo(a,h)anthracene	1.0
Chrysene	0.001
Indeno(1,2,3-cd)pyrene	0.1

To calculate a slope factor for a given PAH the appropriate TEF value is multiplied by the slope factor for benzo(a)pyrene.

For the development of dermal toxicity values, information regarding Gastrointestinal (GI) absorption efficiency for administered doses was used. Specifically, oral slope factors were converted to dermal slope factors by dividing by the GI absorption efficiency. Oral reference doses were converted to dermal reference doses by multiplying by the GI absorption efficiency. The derivation of the dermal toxicity values for this risk assessment is consistent with the USEPA (2004a) recommendation and the GI absorption efficiency recommended by USEPA in its Supplemental Guidance for Dermal Risk Assessment was used for the COPCs in this risk assessment. In the absence of any information on absorption for the substance or chemically related substances, an oral absorption efficiency of 100

percent was assumed in accordance with USEPA Region 2 guidance (personal communication between A. Schatz of Parsons and M. Maddeloni of EPA Region 2).

RfCs were converted to inhalation reference doses in units of milligrams of chemical per kilogram of body weight per day (mg/kg-day); similarly, inhalation unit risk factors were converted to inhalation slope factor in units of per milligrams of chemical per kilogram of body weight per day ((mg/kg-day)⁻¹). The conversion was made by assuming an inhalation rate of 20 m³/day and an adult body weight of 70 kg. Thus:

$$\text{Inhalation slope factor (mg/kg-day)}^{-1} = \text{UnitRisk} \left(\frac{\text{ug}}{\text{m}^3} \right)^{-1} \times \frac{\text{day}}{20\text{m}^3} \times 70\text{kg} \times \frac{1000\text{ug}}{\text{mg}}$$

$$\text{Inhalation Reference Dose (mg/kg/day)} = \text{RfC} \left(\frac{\text{mg}}{\text{m}^3} \right) \times \left(\frac{20\text{m}^3}{\text{day}} \right) \times \left(\frac{1}{70\text{kg}} \right)$$

Chronic RfDs and RfCs are ideally based on chronic exposure studies in humans or animals. Chronic exposure for humans is considered to be exposure of roughly seven years or more, based on exposure of rodents for one year or more in animal toxicity studies. Construction workers and trespassers at the sites were assumed to be exposed to the contaminants at the sites for 1 year and 6 years, respectively; therefore, subchronic RfDs and RfCs would be appropriate to evaluate the non-carcinogenic threshold effects. For this risk assessment, chronic RfDs and RfCs were used to conservatively assess risks for these receptors.

The toxicity factors used in this evaluation are summarized in **Tables 6-11A, 6-11B, 6-11C, and 6-11D**.

6.7 RISK CHARACTERIZATION

To characterize risk, toxicity and exposure assessments were summarized and integrated into quantitative expressions of risk. To characterize potential non-carcinogenic effects, comparisons were made between estimated intakes of substances and toxicity values. To characterize potential carcinogenic effects, probabilities that an individual will develop cancer over a lifetime of exposure were evaluated from estimated intakes and chemical-specific dose-response information.

6.7.1 Non-Carcinogenic Effects

The potential for non-carcinogenic effects is evaluated by comparing an exposure level over a specified period with an RfD derived for a similar exposure period. This ratio of exposure to toxicity is called a hazard quotient according to the following equation:

$$\text{Noncancer Hazard Quotient (HQ)} = I/\text{RfD}$$

Where:

I = Intake or Absorbed Dose (mg/kg-day)

RfD = Reference Dose (mg/kg-day)

The noncancer hazard quotient assumes that there is a level of exposure (i.e., an RfD) below which it is unlikely for even sensitive populations to experience adverse health effects. If the intake or absorbed dose exceeds the threshold (i.e., If I/RfD exceeds one), there may be concern for potential noncancer effects.

To assess the overall potential for non-carcinogenic effects posed by more than one chemical, a hazard index (HI) approach has been developed by the USEPA. This approach assumes that simultaneous sub-threshold exposures to several chemicals could result in an adverse health effect. It also assumes that the magnitude of the adverse effect will be proportional to the sum of the ratios of the subthreshold exposures to respective acceptable exposures.

This is expressed as:

$$HI = I_1/RfD_1 + I_2/RfD_2 + \dots + I_i/RfD_i$$

Where:

I_i = the Intake or absorbed dose of the i^{th} COPC, and

RfD_i = the reference dose for the i^{th} COPC.

While any single chemical with an exposure level greater than the toxicity value will cause the HI to exceed one, for multiple chemical exposures, the HI can also exceed one even if no single chemical exposure exceeds its RfD. The assumption of dose additivity reflected in the HI is best applied to compounds that induce the same effects by the same mechanisms. Applying the HI to cases where the known compounds do not induce the same effect may overestimate the potential for effects. To assess the overall potential for non-carcinogenic effects posed by several exposure pathways, the total HI for chronic exposure is the sum of the HI's for each pathway, for each receptor.

6.7.2 Carcinogenic Effects

For carcinogens, risks are estimated as the incremental probability of an individual developing cancer over a lifetime as a result of exposure to the potential carcinogen (i.e., excess individual lifetime cancer risk). The slope factor converts estimated daily intakes or absorbed dose averaged over a lifetime of exposure directly to incremental risk of an individual developing cancer. It can generally be assumed that the dose-response relationship will be linear in the low-dose portion of the multistage

model dose-response curve. Under this assumption, the slope factor is a constant, and risk will be directly related to intake. Thus, the following linear low-dose equation was used in this assessment:

$$\text{Risk} = \text{CDI} \times \text{SF}$$

Where:

- Risk = A unitless probability of an individual developing cancer,
CDI = Chronic Daily Intake over 70 years (mg/kg-day), and
SF = Slope Factor (mg/kg-day)⁻¹

For simultaneous exposure to several carcinogens, the USEPA assumes that the risks are additive. That is to say:

$$\text{Risk}_T = \text{Risk}_1 + \text{Risk}_2 + \dots + \text{Risk}_i$$

Where:

- Risk_T = Total cancer risk, expressed as a unitless probability, and
Risk_i = Risk estimate for the ith COPC.

Addition of the carcinogenic risks is valid when the following assumptions are met:

- doses are low,
- no synergistic or antagonistic interactions occur, and
- similar endpoints are evaluated.

According to guidance in the National Contingency Plan, the target overall lifetime carcinogenic risks from exposures for determining clean-up levels should range from 10⁻⁴ to 10⁻⁶.

6.7.3 Risk Characterization for Lead Exposure

Risk characterization for lead exposure was conducted based on a comparison between the estimated blood lead level and the target PbB level of concern. Blood lead level was estimated based on the USEPA IEUBK model or the Adult Lead Model. The target PbB level of concern is 10.0 ug/dL for child (USEPA, 1994, 2003d).

6.7.4 Risk Summary

Human health risks were calculated for the construction worker, industrial worker, and child trespasser via exposure to SEAD-59 soil and groundwater, SEAD-59 Stockpile soil, and SEAD-71

soil and groundwater. The risks via various exposure routes were summed up to represent the total risks for the receptors for the following three scenarios: 1) exposure to SEAD-59 soil and SEAD-59 groundwater; 2) exposure to SEAD-59 Stockpile soil and SEAD-59 groundwater; 3) exposure to SEAD-71 soil and SEAD-71 groundwater. The risk results for the above three scenarios are presented in **Tables 6-12A, 6-12B, and 6-12C**, respectively. For each scenario, both the RME and CT values are presented. The risk calculation tables for each exposure route are presented in **Appendices C, D, and E** for SEAD-59 soil and groundwater exposure, SEAD-59 Stockpile soil exposure, and SEAD-71 soil and groundwater exposure, respectively. The following sections summarize the risk characterization results for SEAD-59 soil and groundwater exposure, SEAD-59 Stockpile soil and groundwater exposure, and SEAD-71 soil and groundwater exposure, respectively.

6.7.4.1 SEAD-59

Table 6-12A summarizes the cancer and non-cancer risks for all receptors and exposure routes corresponding to SEAD-59 soil and groundwater exposure. The results for both the RME and CT scenarios are presented. The risk calculation tables for each exposure route are presented in **Appendix C**.

The cancer risks for all receptors based on the RME scenario are below the USEPA upper limit of 1×10^{-4} . The cancer risks for the industrial worker, construction worker, and child trespasser are 2×10^{-5} , 2×10^{-6} , and 2×10^{-6} , respectively. The risks associated with soil ingestion contribute 23%, 38%, and 31% to the total cancer risks for the industrial worker, construction worker, and child trespasser, respectively. PAHs and arsenic in SEAD-59 soil are the primary COPCs contributing to the cancer risks associated with SEAD-59 soil exposure. The risks associated with groundwater intake contribute 51%, 26%, and 53% to the total cancer risks for the industrial worker, construction worker, and child trespasser, respectively. Arsenic in SEAD-59 groundwater is the only COPC contributing to the cancer risks associated with SEAD-59 groundwater exposure.

The total non-cancer hazard indices based on the RME for all receptors are below the USEPA target limit of 1. The non-cancer hazard indices for the industrial worker, construction worker, and child trespasser are 0.3, 0.5, and 0.1, respectively. The risks associated with soil ingestion contribute 45%, 75%, and 56% to the total non-cancer risks for the industrial worker, construction worker, and child trespasser, respectively. Metals (antimony, arsenic, and iron) in SEAD-59 soil are the primary COPCs contributing to the non-cancer risks associated with SEAD-59 soil exposure. The risks associated with groundwater intake contribute 49%, 23%, and 43% to the total non-cancer risks for the industrial worker, construction worker, and child trespasser, respectively. Arsenic and thallium are the only COPCs contributing to the non-cancer risks associated with SEAD-59 groundwater exposure.

The total cancer risks and non-cancer hazard indices based on the CT scenario for all receptors are within the EPA target range (i.e., total non-cancer hazard indices below 1 and total cancer risks below 1×10^{-4}).

6.7.4.2 SEAD-59 Stockpile

Table 6-12C summarizes the cancer and non-cancer risks for all receptors and exposure routes corresponding to SEAD-59 Stockpile soil and SEAD-59 groundwater exposure. The results for both the RME and CT scenarios are presented. It should be noted that the risks associated with groundwater exposure are the same for this scenario and the SEAD-59 soil and groundwater exposure scenario. The risk calculation tables for stockpile soil related exposure pathways are presented in **Appendix D** and the risk calculation tables for groundwater related exposure pathways are presented in **Appendix C**.

The cancer risks for all receptors based on the RME scenario are below the USEPA upper limit of 1×10^{-4} . The cancer risks for the industrial worker, construction worker, and child trespasser are 5×10^{-5} , 3×10^{-6} , and 4×10^{-6} , respectively. The risks associated with soil ingestion contribute 23%, 43%, and 37% to the total cancer risks for the industrial worker, construction worker, and child trespasser, respectively. PAHs in stockpile soil are the primary COPCs contributing to the cancer risks associated with stockpile soil exposure.

The total non-cancer hazard indices based on the RME for all receptors are below the USEPA target limit of 1. The non-cancer hazard indices for the industrial worker, construction worker, and child trespasser are 0.2, 0.5, and 0.1, respectively. The risks associated with soil ingestion contribute 44%, 72%, and 51% to the total non-cancer risks for the industrial worker, construction worker, and child trespasser, respectively. Metals (antimony, arsenic, and iron) in stockpile soil are the primary COPCs contributing to the non-cancer risks associated with stockpile soil exposure.

The total cancer risks and non-cancer hazard indices based on the CT scenario for all receptors are within the EPA target range (i.e., total non-cancer hazard indices below 1 and total cancer risks below 1×10^{-4}).

6.7.4.3 SEAD-71

Table 6-12B summarizes the cancer and non-cancer risks for all receptors and exposure pathways corresponding to SEAD-71 soil and groundwater exposure. The results for both the RME and CT scenarios are presented. The risk calculation tables for each exposure route are presented in **Appendix E**.

The cancer risks based on the RME scenario are below the USEPA upper limit of 1×10^{-4} for all receptors with the exception of the industrial worker. The cancer risks for the industrial worker,

construction worker, and child trespasser are 2×10^{-4} , 1×10^{-5} , and 1×10^{-5} , respectively. The risks associated with soil ingestion contribute 24%, 41%, and 41% to the total cancer risks for the industrial worker, construction worker, and child trespasser, respectively. The risks associated with soil dermal contact contribute 66%, 50%, and 47% to the total cancer risks for the industrial worker, construction worker, and child trespasser, respectively. PAHs in SEAD-71 soil are the primary COPCs contributing to the cancer risks associated with SEAD-71 soil exposure.

The total non-cancer hazard indices based on the RME for all receptors are above or at the USEPA target limit of 1. The non-cancer hazard indices for the industrial worker, construction worker, and child trespasser are 3, 3, and 1, respectively. The risks associated with groundwater intake contribute 96%, 88%, and 95% to the total non-cancer risks for the industrial worker, construction worker, and child trespasser, respectively. Iron and manganese in SEAD-71 groundwater are the primary COPCs contributing to the non-cancer risks associated with SEAD-71 groundwater exposure.

The total cancer risks based on the CT scenario for all receptors are within the EPA target range (i.e., the total cancer risks below 1×10^{-4}). The total non-cancer hazard indices based on the CT scenario for the child trespasser is below the EPA target limit of 1 while the total non-cancer hazard indices for the industrial worker and construction worker are 2, above the USEPA target limit of 1.

6.7.4.4 Lead Risk Characterization Results

Lead was identified as a COPC in SEAD-71 soil and groundwater and in SEAD-59 Stockpile soil. This section presents the results of the quantitative and qualitative assessment of the risk from lead exposure at the sites.

SEAD-71

The lead risk characterization results for SEAD-71 soil exposure are presented in **Tables E-11** and **E-12** for the industrial worker and construction worker, respectively. The 95th percentile PbB among fetuses of adult industrial workers are 5.0 and 7.4 ug/dL, assuming a homogeneous and a heterogeneous population, respectively. Both estimates are below the USEPA target PbB level of concern (i.e., 10 ug/dL). The 95th percentile PbB among fetuses of adult construction workers are 5.5 and 8.0 ug/dL, for a homogeneous and a heterogeneous population, respectively. Both estimates are below the USEPA target PbB level of concern (i.e., 10 ug/dL).

The lead risk characterization results for child with SEAD-71 soil and groundwater exposure are presented in **Table E-13**. It should be noted that a child resident was assumed by using the IEUBK model. As the exposure frequency for a child trespasser is much less than a child resident, the results were used as a screening tool to evaluate potential risk for the child receptor. As the 95th percentile PbB among child residents are below the USEPA target PbB level of concern (i.e., 10 ug/dL), it is

concluded that lead level in SEAD-71 soil and groundwater does not pose a health risk to the child trespasser receptor.

SEAD-59 Stockpile Soil

The lead risk characterization results for SEAD-59 Stockpile soil exposure are presented in **Tables D-7** and **D-8** for the industrial worker and construction worker, respectively. The 95th percentile PbB among fetuses of adult industrial workers are 4.7 and 7.1 ug/dL, assuming a homogeneous and a heterogeneous population, respectively. Both estimates are below the USEPA target PbB level of concern (i.e., 10 ug/dL). The 95th percentile PbB among fetuses of adult construction workers are 5.0 and 7.4 ug/dL, for a homogeneous and a heterogeneous population, respectively. Both estimates are below the USEPA target PbB level of concern (i.e., 10 ug/dL).

The lead risk characterization results for child with SEAD-59 Stockpile soil exposure are presented in **Table D-9**. It should be noted that a child resident was assumed by using the IEUBK model. As the exposure frequency for a child trespasser is much less than a child resident, the results were used as a screening tool to evaluate potential risk for the child receptor. As the 95th percentile PbB among child residents are below the USEPA target PbB level of concern (i.e., 10 ug/dL), it is concluded that lead level in SEAD-59 Stockpile soil does not pose a health risk to the child trespasser receptor.

6.8 UNCERTAINTY ANALYSIS

All risk assessments involve the use of assumptions and professional judgments to varying degrees. This results in uncertainty in the final estimates of risk. There are uncertainties associated with each component of the risk assessment from data collection through risk characterization. The qualitative evaluation of uncertainty associated with the four major steps (site characterization and data evaluation, exposure assessment, toxicity assessment, and risk characterization) of the risk assessment is discussed below in **Sections 6.8.1** through **6.8.4**. **Section 6.8.5** presents a quantitative evaluation of uncertainty associated COPC screening approach and specific relative bioavailability and exposure assumptions.

6.8.1 Uncertainty in Site Characterization and Data Evaluation

The baseline human health risk assessment was conducted based on all data available for the sites. Close to 200 SEAD-59 soil samples, over 70 SEAD-71 soil samples, over 50 SEAD-59 Stockpile samples, 13 SEAD-59 groundwater samples, and eight SEAD-71 groundwater samples were included in the baseline human health risk assessment. The samples were collected biased toward overestimation of chemical concentrations at the sites. The size of the soil samples and the biased sampling approach indicate the uncertainty associated with site characterization is low.

Uncertainty in contaminant identification is considered low because generally full suite of CLP target compounds including VOCs, SVOCs, PCBs, pesticides, and metals were analyzed for the samples. Reasonable certainty also is assumed because of the sample data validation and quality assurance/quality control procedures applied to sample analysis and data evaluation.

Chemicals were screened against USEPA Region 9 PRGs or other appropriate screening values and only those with the maximum detected concentrations exceeding the screening values were included in the risk characterization. As a conservative step, the PRGs for the residential scenario were used for SEAD-59/71, a site planned for future industrial development. Region 9 PRGs were derived based on direct contact exposure (i.e., ingestion and dermal contact for soil and intake and inhalation for tap water) and a target cancer risk of 1×10^{-6} or a target hazard quotient of 1, whichever is lower. The COPC screening conducted for this risk assessment might underestimate potential risks due to the following facts: 1) Using a PRG corresponding to a hazard quotient of 1 might screen out COPCs that might contribute significantly to the total risks; and 2) using this approach might screen out COPCs that might contribute significantly to the total risks via exposure pathways not covered under the Region 9 PRG calculation. However, as the exposure pathways covered under the Region 9 PRG calculation are normally the most risk-contributing exposure pathways, this fact is not expected to significantly impact the results.

To address the uncertainty associated with the first fact, the COPC screening was revised by comparing the maximum detected concentrations with the Region 9 PRGs corresponding to a target cancer risk of 1×10^{-6} or a target hazard quotient of 0.1, whichever is lower. Several additional COPCs, as shown below, were identified using this approach.

Additional COPCs By Using 0.1PRGs for PRGs Based on Non-Carcinogenic Effects

Medium	SEAD-59	SEAD-59 Stockpile	SEAD-71 (Outside Fenced Area)
Soil (Surface/Total Soil)	Aluminum Manganese Thallium Vanadium	Aluminum Manganese Thallium Vanadium	2-Methylnaphthalene Naphthalene Aluminum Antimony Manganese Thallium Vanadium
Groundwater	Antimony Iron Manganese Vanadium		Aluminum Antimony Chromium Vanadium

The risk calculation was re-performed to include the above additional COPCs, along with other revised assumptions for uncertainty analysis (i.e., a default bioavailability of 1 was used for all

COPCs for soil ingestion and an adolescent trespasser was used to replace the child trespasser; see discussion presented in **Section 6.8.2**). The COPC screening and risk calculation results are presented in **Appendix G**. Detailed discussion of the risk results is presented in **Section 6.8.5**. In brief, the revised COPC screening approach, along with the other revised assumptions for uncertainty analysis, would not change the overall risk assessment conclusion for the sites.

6.8.2 Uncertainty in Exposure Assessment

Factors that can contribute to uncertainty in the exposure assessment include identification and evaluation of exposure pathways, assumptions for exposure scenario development, exposure parameters, and derivation of exposure point concentrations.

The identification of potential exposure pathways and receptors is based on site-specific reasonable current use and foreseeable future land use. To the extent possible, site-specific receptors and exposure parameters were identified and tailored to those would minimize uncertainty in the postulated scenarios and exposure assessments. For example, the future receptors were assumed to drink groundwater. It is extremely unlikely that this will occur, since there is a current acceptable water supply, and the aquifer beneath the sites is not believed to be productive enough to supply the drinking water needs at the sites. This assumption yields an overestimate of risk for this scenario. As another example, a child age 0-6 years old was selected to evaluate potential risks to trespassers, as children are more sensitive populations compared with adolescents or adults. Evaluating risk to the child trespasser is a conservative step and will result in potential overestimate of potential risks to trespassers. As adolescents are more likely to trespass at the sites, the risk assessment was re-performed for an adolescent receptor (age 11-16 years old) with the same exposure frequency (i.e., 14 days/year) to evaluate the potential uncertainty. The risk calculation tables are presented in **Appendix G** and the risk results are discussed in detail in **Section 6.8.5**. In brief, there will be no significant risks to the potential adolescent trespasser and the revised risk results will not affect the overall risk conclusion.

Values assumed for exposure parameters (e.g., soil ingestion rate, inhalation rate, and exposure frequencies) used in calculations for intakes are based primarily on USEPA guidance. These assumptions may result in underestimating or overestimating the intakes for specific receptors, depending on the accuracy of the assumptions relative to actual site conditions and uses. For the scenarios in this risk assessment, upper bound values were selected for each exposure factor for the RME scenario. In the calculations of exposure, these multiple upper-bound exposure factor estimates compound to yield intakes and absorbed doses that likely overestimate exposure levels. Evaluation of uncertainty associated with adolescent trespasser exposure frequency is presented in **Section 6.8.5**. Overall, even if the exposure frequency were increased from 14 days/year to 50 days/year, there would be no significant risks to the potential adolescent trespasser.

The 95% UCL, or other appropriate UCL recommended by USEPA, of the mean was used to represent exposure point concentrations and to calculate site-related risks. This is a conservative approach which tends to overstate potential risks. The EPCs derived from the measured chemical concentrations are assumed to persist without change for the entire duration of each exposure scenario. It is likely that some degradation would occur over time, particularly for some of the organic compounds, which would reduce the current concentrations. Therefore, this steady state assumption tends to overestimate exposure levels.

To estimate EPCs in ambient air from soil dust for construction worker, a USEPA recommended model was used to calculate EPCs based on emissions from truck traffic on unpaved roads. The EPCs estimated using this model may overestimate the EPCs as dust caused by wind erosion and other construction activities such as soil excavation and loading are expected to be lower than those caused by emission from truck traffic on unpaved roads.

For this baseline human health risk assessment, relative bioavailability for all COPCs at the sites was assumed to be one with the exception of oral-soil relative bioavailability for PAHs. That is, COPCs in affected media were assumed to be absorbed the same degree as they were absorbed in the toxicity study from which the toxicity values were developed. This is a very conservative assumption, especially for soil. Chemicals can form complexes with soil particles, thus reducing their ability to be absorbed, or their bioavailability. Therefore, the potential risks will be overstated assuming relative bioavailability of one. The relative bioavailability of PAHs for soil ingestion exposure is from a peer-reviewed paper by Magee et al. (1996). The bioavailability value presented in the paper was an estimate of multiple available studies and has been adopted by states such as Massachusetts. The use of relative bioavailability in general is consistent with the USEPA guidance. As an example, an oral bioavailability of 0.6 is used by USEPA for lead models. In addition, the relative bioavailability was based on multiple available studies and has been through peer reviews. Therefore, the use of PAH relative bioavailability for soil ingestion is expected to produce reasonable risk estimates. Nonetheless, to demonstrate potential uncertainty associated with the use of relative bioavailability for PAHs, risks via soil ingestion exposure were re-calculated by using relative bioavailability of 1 for all COPCs. The results are presented in **Appendix G**. **Table G-5A** presents risk calculation for SEAD-59 soil ingestion under RME scenario. **Table G-5B** illustrates risk calculation for SEAD-59 Stockpile soil ingestion under the RME scenario. **Table G-5C** shows risk calculation for ingestion of SEAD-71 soil outside the Fenced Area under the RME scenario. **Tables 6-13A** through **6-13C** summarize total risks under the RME scenario for exposure at SEAD-59, SEAD-59 Stockpiles, and SEAD-71 outside the Fenced Area, respectively. Detailed discussion of the risk results is presented in **Section 6.8.5**. In summary, using a relative bioavailability of 1 for all COPCs would not change the overall risk characterization conclusion.

To characterize exposure to lead in soil and groundwater, the USEPA adult lead model was used for the industrial worker and construction worker. The USEPA IEUBK model assuming a child resident was used as a screening tool for child trespasser, who is exposed infrequently at the sites. The model results tend to overestimate potential risks for child trespasser and therefore were only used as a screening tool

for child trespasser. It should be noted that the adult lead model does not evaluate exposure via groundwater intake; therefore, may underestimate potential risks associated with lead in groundwater. However, this is not expected to significantly impact the results as the IEUBK model indicates no potential risk from lead in groundwater on the child receptor, the most sensitive receptor.

Default dermal absorption values recommended by USEPA (2004a) were used for this risk assessment. Because various factors affect the efficiency of dermal absorption, there is considerable uncertainty associated with these values. For example, some of the default dermal absorption values are based on studies of dermal absorption of metals in aqueous solutions; dermal uptake of metals in soil is likely to be lower. In addition, many compounds are only absorbed through the skin after a long exposure duration (*i.e.*, >24 hours). Since most individuals bathe at least once each day, washing may remove any soil residues adhering to the skin before absorption can occur. Therefore, dermal absorption rates based on studies with long exposure durations may overestimate actual absorption. As an example, the default dermal absorption value for PAHs may overstate potential risks associated with dermal exposure to soil. In contrast with the default value of 13%, which is based on a single data set, the dermal absorption value of 2%, as recommended by Magee *et al.* (1996), is a point estimate based on four different data sets, including the *in vivo* data from Wester *et al.* (1990); human *in vitro* data also from Wester *et al.*; as well as *in vivo* and *in vitro* data in rats, from Yang *et al.*, (1989, as cited in Magee *et al.*, 1996). Because no single study is ideal for estimating dermal absorption, it seems appropriate to base dermal absorption on several data sets, each of which seem equally suited for a deriving dermal absorption factor. It should be noted that if the alternative dermal absorption factor (0.2) were used for PAHs, all cancer risks (including cancer risks at SEAD-71) would be within the USEPA limits.

6.8.3 Uncertainty in Toxicity Assessment

Uncertainty is inherent in the toxicity values used in characterizing the carcinogenic and non-carcinogenic risks. Such uncertainty is chemical-specific and is incorporated into the toxicity value during its development. For example, an uncertainty factor may be applied for interspecies and intrahuman variability, for extrapolation from subchronic to chronic exposures, and/or for epidemiological data limitations. Most cancer slope factors are calculated using a model that extrapolates low dose effects from high dose animal studies. Because toxicity constants are generally based on the upper limit of the 95th-percentile confidence interval or incorporate safety factors to compensate for uncertainty, chemical-specific risks may be overestimated. In addition, chronic toxicity values were used to evaluate subchronic non-cancer risks in this baseline risk assessment due to the general lack of subchronic toxicity values. This practice will potentially overstate risks for the construction worker and the child trespasser.

Toxicity values may not be available for some COPCs, thereby precluding their inclusion in the quantitative risk estimates. The resulting risk estimates will not include the chemical-specific risks from these chemicals, and, therefore, may underestimate risk. Risks associated with exposure to iron were assessed using the toxicity value (RfD) developed by USEPA National Center for

Environmental Assessment. The toxicity value has not yet been adopted by USEPA IRIS database or the PPRTV database. Risks associated with exposure to PAHs were assessed using the TEF approach. The potential hazards/risks associated with these chemicals may be uncertain.

Toxicity information was not available for dermal exposure. This is due to the lack of scientific studies available to quantify dermal toxicity and carcinogenic potential for the vast majority of priority pollutants and because chemical specific information needed to convert ingested dose to absorbed dose is not available. In accordance with the USEPA (2004a) guidance, oral toxicity values were used with adjustment to derive dermal toxicity values. The dermal toxicity value developed using this approach may result in over or under estimation of potential risks associated with dermal exposure.

6.8.4 Uncertainty in Risk Characterization

Some of the procedures used and uncertainties inherent in the human health risk characterization process may tend to underestimate or overestimate potential risk. The summing of hazard quotients for all COPCs represents a conservative approach because the reference dose (or the reference concentration) for a given COPC for a given pathway is calculated for a certain toxicological endpoint (*e.g.*, liver, kidneys, etc.). To calculate an accurate estimate of potential non-carcinogenic health risks, HQs with the same toxicological endpoints should only be summed. Therefore, the risks calculated by summing the HQs for all COPCs are likely overstated. On the other hand, the assumption of additivity does not allow for potential synergistic or antagonistic effects of various chemicals, which may result in an underestimation or overestimation of risk, respectively.

6.8.5 Quantitative Uncertainty Analysis

As discussed in the previous sections (**Sections 6.8.1** and **6.8.2**), a risk assessment was re-performed for SEAD-59, SEAD-59 Stockpile soil, and SEAD-71 (outside the Fenced Area) under the RME scenario with the following revised approach/assumptions to evaluate potential uncertainty to the potential risks to human health.

- The COPC screening was conducted by comparing the maximum detected concentrations with Region 9 PRGs corresponding to a target cancer risk of 1×10^{-6} or a target hazard quotient of 0.1, whichever is lower;
- An adolescent trespasser (ages 11-16 yr) was evaluated in lieu of the child trespasser with the same exposure frequency (*i.e.*, 14 days/year). An exposure frequency of 50 days/year was also evaluated and the results are presented in **Section 6.8.5.3**; and
- A default relative bioavailability of 1 was used for all COPCs to evaluate risk via soil ingestion.

The risk results are summarized in **Tables 6-13A**, **6-13B**, and **6-13C** for SEAD-59, SEAD-59

Stockpile soil, and SEAD-71 outside the Fenced Area, respectively and the risk calculation sheets are presented in **Appendix G**. This section presents a discussion of the risk results and potential impact to the human health risk assessment conclusion caused by the above revisions.

6.8.5.1 Quantitative Uncertainty Analysis Results Summary

For exposure to SEAD-59 soil and groundwater, as shown in **Table 6-13A**, the cancer risks for all receptors based on the RME scenario are below the USEPA upper limit of 1×10^{-4} . The cancer risks for the industrial worker, construction worker, and adolescent trespasser are 2×10^{-5} , 2×10^{-6} , and 5×10^{-7} , respectively. The total non-cancer hazard index based on the RME for the adolescent trespasser was below the USEPA target limit of 1 at 0.1. The non-cancer hazard indices for the industrial worker and construction worker are 1 and 9, respectively. For the industrial worker, the risk associated with groundwater intake contributes 72% to the total non-cancer risk. That is, with groundwater use at the sites prohibited, SEAD-59 is not expected to cause unacceptable risk to potential industrial workers. For the construction worker, the risks associated with inhalation of dust in ambient air and groundwater intake contribute 84% and 9% to the total non-cancer risk. Aluminum and manganese in SEAD-59 soil are the only COPCs contributing to the non-cancer risk associated with inhalation of dust in ambient air. As discussed in the following section, aluminum and manganese in SEAD-59 soil are consistent with the Seneca background levels. Therefore, the elevated risks associated with inhalation of dust in ambient air are caused by site background and are not related to any site release.

For exposure to SEAD-59 Stockpile soil and SEAD-59 groundwater, as shown in **Table 6-13B**, the cancer risks for all receptors based on the RME scenario are below the USEPA upper limit of 1×10^{-4} . The cancer risks for the industrial worker, construction worker, and adolescent trespasser are 6×10^{-5} , 6×10^{-6} , and 1×10^{-6} , respectively. The total non-cancer hazard index based on the RME for the adolescent trespasser was below the USEPA target limit of 1 at 0.1. The non-cancer hazard indices for the industrial worker and construction worker are 1 and 2, respectively. For the industrial worker and construction worker, the risks associated with groundwater intake contribute 73% and 56%, respectively to the total non-cancer risks. That is, with groundwater use at the sites prohibited, SEAD-59 Stockpile soil is not expected to cause unacceptable risks to potential industrial workers or construction workers.

For exposure to SEAD-71 soil and groundwater outside the Fenced Area, as shown in **Table 6-13C**, the cancer risks for all receptors based on the RME scenario are below the USEPA upper limit of 1×10^{-4} . The cancer risks for the industrial worker, construction worker, and adolescent trespasser are 4×10^{-5} , 4×10^{-6} , and 8×10^{-7} , respectively. The total non-cancer hazard index based on the RME for the adolescent trespasser was below the USEPA target limit of 1 at 0.5. The non-cancer hazard indices for the industrial worker and construction worker are 3 and 10, respectively. For the industrial worker, the risk associated with groundwater intake contributes 91% to the total non-cancer risk. That is, with groundwater use at the sites prohibited, SEAD-71 soil outside the Fenced Area is not

expected to cause unacceptable risk to potential industrial workers. For the construction worker, the risks associated with inhalation of dust in ambient air, groundwater intake, and dermal contact to groundwater contribute 84%, 25%, and 4% to the total non-cancer risk. Aluminum, manganese, and naphthalene in SEAD-71 soil outside the Fenced Area are the only COPCs contributing to the non-cancer risks associated with inhalation of dust in ambient air and contribution from naphthalene being negligible (i.e., < 0.001%). As discussed in the following section, aluminum and manganese in SEAD-71 soil outside the Fenced Area are consistent with the Seneca background levels.

6.8.5.2 Aluminum and Manganese Background Comparison

As discussed in the previous section, aluminum and manganese in SEAD-59 soil and SEAD-71 soil outside the Fenced Area are causing non-cancer risks for potential construction workers exceeding the USEPA limit of 1. This section presents a comparison of the Seneca background levels with the concentrations in SEAD-59 soil and SEAD-71 soil outside the Fenced Area, respectively for aluminum and manganese. Information of Seneca background data is presented in **Section 6.3.2** of this report.

Summary descriptive statistics are presented in **Table 6-14**. As shown in the table, for both SEAD-59 soil and SEAD-71 soil outside the Fenced Area, the three descriptive statistics parameters (i.e., maximum, arithmetic mean, and 95% UCL) for aluminum and manganese are all below the corresponding statistics parameters for Seneca background. Therefore, aluminum and manganese concentrations at SEAD-59 and SEAD-71 outside the Fenced Area are not above the Seneca background levels.

In addition to the descriptive statistics comparison, both non-parametric (Mann-Whitney T test) and parametric (Student's T test) statistical test methods were used for the background comparison analysis. One-tailed (one-sided) Mann-Whitney tests and Student's T tests were conducted for the data using XLSTAT (Version 05-11-16). Both tests assumed 0.05 as the significance level. The statistical test results are presented in **Appendix H**. It should be noted that although the Student's T test is based on normal distribution assumption, USEPA (2002c) recommends the use of Student's T Test if a larger number of data points are available ($n > 25$) and indicates that the parametric test will work well when the sample size is large. The three data sets (i.e., SEAD-59 soil, SEAD-71 soil outside the Fenced Area, and Seneca soil background) used for this background comparison all have more than 50 data points; therefore, the Student's T tests should perform sufficiently for the background comparison.

As shown in **Appendix H**, the results from the Student's T tests are consistent with the Mann-Whitney test results. Both tests conclude that the aluminum and manganese concentrations observed in SEAD-59 soil and SEAD-71 soils outside the Fenced Area are not statistically above the Seneca background levels.

6.8.5.3 Adolescent Trespasser Exposure Frequency Uncertainty Analysis

Table 6-13A through **Table 6-13C** present the risks for an adolescent trespasser (ages 11-16 yr) with exposure to soil and groundwater at an exposure frequency of 14 days/year. The 14 days/year exposure frequency was selected based on best professional judgment and site-specific conditions. The Depot is situated in a sparsely populated rural area; it is fenced to limit access and is occasionally patrolled by site security personnel. SEAD-59 and SEAD-71 are both located in close proximity to the Army's current office locations (within 500 feet), and both are typified as relatively open and generally flat. Further, the setting of SEAD-59/71 is generally similar to the surrounding areas and there are no areas that may attract special attention from potential adolescent trespassers. Therefore, trespassing at SEAD-59/71 is considered unlikely to occur frequently or for extended periods without individuals being challenged or noticed. On this basis, a 14 days/year exposure frequency is considered a reasonable assumption for the sites. Nonetheless, an elevated exposure frequency, 50 days/year (equivalent to two days a week for 25 weeks or approximately half a year), was evaluated for the uncertainty analysis. As the risks (including total cancer risk and non-cancer hazard index) are in linear relationship with the exposure frequency for the adolescent trespasser (as illustrated in the generic intake equation presented in **Section 6.5.3**, along with the risk characterization equation presented in **Section 6.7**; specific equations for each exposure pathway are also presented in the risk calculation sheets presented in **Appendix G**), the risks for the adolescent receptor with an exposure frequency of 50 days/year can be easily inferred from the risks associated with 14 days/year exposure frequency (as presented in **Tables 6-13A** through **6-13C**) and are summarized in **Table 6-15**.

As shown in **Table 6-15**, the total cancer risk and non-cancer risk for the adolescent trespasser with exposure frequency of 50 days/year are below the USEPA limits ($1E-4$ for cancer risk and 1 for hazard index) via exposure to COPCs in SEAD-59 soil and groundwater.

The total cancer risk and non-cancer risk for the adolescent trespasser with exposure frequency of 50 days/year are below the USEPA limits via exposure to COPCs in SEAD-59 stockpile soil and SEAD-59 groundwater (**Table 6-15**).

The total cancer risk for the adolescent trespasser with exposure frequency of 50 days/year is below the USEPA limit via exposure to COPCs in SEAD-71 soil and groundwater outside the Fenced Area (**Table 6-15**). The hazard index for the adolescent trespasser with exposure frequency of 50 days/year is slightly above the USEPA limit (2 vs. 1) via exposure to COPCs in SEAD-71 soil and groundwater outside the Fenced Area. The elevated hazard index is mainly caused by groundwater intake, which contributes 97% of the total risk. The Army intends to place institutional controls in the form of land use restrictions on the PID parcels (including SEAD-59 and SEAD-71) and access to or use of groundwater is proposed to be prohibited until the Class GA Groundwater Standards are met. If a groundwater use restriction were in place, the risks for the adolescent trespasser with an exposure frequency of 50 days/year would be below the USEPA limits via exposure to COPCs in SEAD-71 soil and groundwater outside the Fenced Area.

In summary, the 14 days/year exposure frequency used for this risk assessment was a reasonable and conservative assumption based on the site-specific conditions. Even if an elevated exposure frequency (50 days/year) were used, there would be no unacceptable risks to the adolescent trespasser at SEAD-59 or SEAD-71 outside the Fenced Area as long as groundwater use restriction is in place at the sites.

6.8.5.4 Quantitative Uncertainty Analysis Conclusion

The risk assessment was repeated with the following revised approach/assumptions to evaluate potential uncertainty of the risk assessment.

- The COPC screening was conducted by comparing the maximum detected concentrations with Region 9 PRGs corresponding to a target cancer risk of 1×10^{-6} or a target hazard quotient of 0.1, whichever is lower;
- An adolescent trespasser (ages 11-16 yr) was evaluated in lieu of the child trespasser with the same exposure frequency (i.e., 14 days/year); risk assessment was repeated further for an elevated exposure frequency of 50 days/year; and
- A default relative bioavailability of 1 was used for all COPCs to evaluate risk via soil ingestion.

To conclude, the above approach or revised assumptions are not expected to impact the overall risk assessment conclusions at the sites. With the recommended institutional controls (i.e., restriction of groundwater use and access and prohibition of residential housing, school, childcare facility and playground development) in place for the sites, the sites would not pose unacceptable risks to human health. Although elevated non-cancer risks were identified for construction workers, the risks were caused by background metal levels at the sites.

6.9 COC IDENTIFICATION

This section presents the COC identification based on the human health risk assessment results.

6.9.1 SEAD-59 Soil and Groundwater

As discussed in **Section 6.7.4.1**, the total cancer risks and non-cancer hazard indices based on the RME and CT scenarios for all receptors with exposure to SEAD-59 soil and groundwater are within the USEPA target range (i.e., total non-cancer hazard indices below 1 and total cancer risks below 1×10^{-4}). Therefore, no COCs were identified for SEAD-59 soil or groundwater.

6.9.2 SEAD-59 Stockpile Soil

As discussed in **Section 6.7.4.2**, the total cancer risks and non-cancer hazard indices based on the RME and CT scenarios for all receptors with exposure to SEAD-59 Stockpile soil and SEAD-59 groundwater are within the USEPA target range (i.e., total non-cancer hazard indices below 1 and total cancer risks below 1×10^{-4}). Therefore, no COCs were identified for SEAD-59 Stockpile soil or SEAD-59 groundwater.

As discussed in **Section 6.7.4.4**, the lead level in SEAD-59 Stockpile soil does not pose a health risk to the receptors.

6.9.3 SEAD-71 Soil and Groundwater

As discussed in **Section 6.7.4.3**, the total cancer risks based on the RME and CT scenarios are below the USEPA upper target limit (1×10^{-4}) for the construction worker and child trespasser. The total cancer risk based on the RME is above the USEPA upper target limit for the industrial worker (2×10^{-4} vs. 1×10^{-4}). PAHs in SEAD-71 soil are the primary COPCs contributing to the cancer risks associated with SEAD-71 soil exposure.

The total non-cancer hazard indices based on the RME for all receptors are above or at the USEPA target limit of 1, due to groundwater intake. Risks via all exposure pathways but groundwater intake are below the USEPA target limit of 1. Iron and manganese in SEAD-71 groundwater are the primary COPCs contributing to the elevated non-cancer risks at SEAD-71.

As discussed in **Section 6.7.4.4**, the lead levels in SEAD-71 soil and groundwater in general do not pose a health risk to the receptors. Therefore, lead should not be considered as a COC at the site.

Based on the above discussions, PAHs in SEAD-71 soil and iron and manganese in SEAD-71 groundwater were further evaluated in this section to assess whether or not they should be identified as COCs for the site.

6.9.3.1 PAHs in SEAD-71 Soil

Elevated PAH concentrations were detected in the Fenced Area located between Building 114 and Building 127. The Fenced Area is paved with paved/crushed stone and asphalt. Based on a further review of the data, it is concluded that the elevated PAH concentrations are not associated with any release at the site. The rationales are summarized as follows.

1. Elevated PAH concentrations detected in surface soil within the Fenced Area are likely caused by asphalt materials in the hard fill and oil used in the construction of the area.

The PAH concentrations in surface soil within the Fenced Area are generally elevated compared with the PAH concentrations in soil outside the Fenced Area at SEAD-71. As an example, the maximum detected benzo(a)pyrene concentration within the Fenced Area is 120 mg/kg while the maximum detected benzo(a)pyrene concentration in the other area at SEAD-71 is 22 mg/kg. The arithmetic mean of all SEAD-71 surface soil samples (including the samples within the Fenced Area) is 7.7 mg/kg while the arithmetic mean of surface soil samples excluding samples within the Fenced Area is 1.0 mg/kg.

- The elevated PAH concentrations detected in surface soil within the Fenced Area are likely caused by the crushed asphalt materials in the hard fill and the oil used in the construction of the storage area. The ground surface within the Fenced Area is generally paved or covered with pieces of asphalt and stone. The asphalt pavement is as thick as 0.1 ft at sample locations such as SS71-12, -13, and -17 and the surface soil samples were collected from 0-0.2 ft bgs. At the time of construction, the Army typically utilized hard fill consisting of oiled crushed stone to form a sturdy base for areas subjected to heavy vehicular traffic and storage operations. The oil was used to help in the compaction of the crushed stone and aided in dust suppression. The hard fill prevented operations from being impacted by muddy and unstable soils and it was placed throughout the SEAD-71 Fenced Area. The presence of asphalt is noted in the boring log of MW71-1 presented in the ESI report (Parsons, 1996) and field notes recorded while surface soil samples were collected within the Fenced Area. The crushed asphalt materials in the hard fill and the oil used in the construction of the storage area are likely the cause of the consistently elevated PAH concentrations throughout the Fenced Area.
2. The soil underneath the pavement is not impacted by PAHs.

Only the surface soil within the Fenced Area was impacted by PAHs. As an example, all PAH concentrations with BAP equivalence above 10 mg/kg were detected in surface soil (0-0.2 ft bgs.). The PAH concentrations in the soil samples from test pit TP71-2 collected at 1, 2.5, and 3 ft bgs were at least one order of magnitude lower than the PAH concentrations detected in surface soil samples.

3. The Fenced Area is not associated with any CERCLA release.

The contaminant sources at SEAD-71 are waste materials that were disposed of onsite. It should be noted that the source areas (i.e., the waste material disposal area) were excavated during the 2002 TCRA by ENSR (2002a). The Fenced Area has historically been known to be a pavement where equipment was stored. As a result, no waste material is expected to be disposed within the Fenced Area as a result of the Seneca Army Depot Activity.

Based on the above discussion, it is concluded that the elevated PAH concentrations in surface soil within the Fenced Area at SEAD-71 are not associated with any release at the site. Therefore, a risk assessment was conducted for SEAD-71 by excluding all soil data from the Fenced Area. The COPC screening, EPC evaluation, and risk calculation sheets are presented in **Appendix F**. A summary of risk results is presented in **Table 6-12D**.

As shown in **Table 6-12D**, the total cancer risks based on the RME and CT scenarios for all receptors with exposure to SEAD-71 soil (outside the Fenced Area) and SEAD-71 groundwater are within the USEPA upper target limit of 1×10^{-4} . The total non-cancer hazard indices based on the RME are above the USEPA limit of 1 for all receptors. Iron and manganese in groundwater are the primary contributors to the elevated risks and further discussion is provided in the following section.

Based on the fact that the elevated PAH concentrations within the Fenced Area are not related to a release at the site and that PAHs in soils outside the Fenced Area at SEAD-71 will not result in risks exceeding the USEPA limit, PAHs in SEAD-71 soil are not considered as COCs for the site. In addition, as discussed in the uncertainty section, uncertainty associated with dermal exposure pathway is likely to overstate potential cancer risks at the site. If the alternative dermal absorption factor (0.2) were used for PAHs, cancer risks for all receptors would be within the USEPA target limit.

6.9.3.2 Iron and Manganese in SEAD-71 Groundwater

Iron and manganese in SEAD-71 groundwater are the primary COPCs contributing to the elevated non-cancer risks at SEAD-71 (i.e., non-cancer hazard indices based on the RME for all receptors above or at the USEPA target limit of 1). This section presents a further evaluation of whether iron and manganese should be considered as COCs for the site.

A comparison of the iron and manganese concentrations in SEAD-71 groundwater with the corresponding concentrations in the Seneca groundwater background data set was conducted in accordance with the USEPA (2002c) Guidance for Comparing Background and Chemical Concentrations in Soil for CERCLA Sites. According to USEPA (2002c), several methods are available for comparing background to site data. These can be divided into several major categories: data ranking and plotting, descriptive summaries, simple comparison, parametric tests, and nonparametric tests. As the data set size for SEAD-71 groundwater is small (total sample number is eight), the comparison with background was conducted by comparing the descriptive statistics between the SEAD-71 groundwater data set and the SEDA background data set. Background data sets are provided in **Appendix B**.

	Iron		Manganese	
	SEAD-71	SEDA Background	SEAD-71	SEDA Background
Sample Number	8	28	8	28
Minimum (mg/L)	0.023	0.011	0.008	0.003
25 th percentile (mg/L)	0.037	0.244	0.014	0.026
Median (mg/L)	0.116	0.506	0.062	0.097
Arithmetic Mean (mg/L)	5.063	3.92	0.633	0.194
Maximum (mg/L)	35.1	69.4	2.68	1.12
75 th percentile (mg/L)	1.577	1.250	0.838	0.253
90 th percentile (mg/L)	13.66	6.855	1.98	0.474

The above table shows that the 25th percentile and the median concentrations of iron and manganese in SEAD-71 groundwater are below the corresponding concentrations in SEDA background. For iron, the arithmetic mean, the 75th percentile, and the 90th percentile of the SEAD-71 data set are greater than, but within two times of the corresponding values for the SEDA background data set. For manganese, the arithmetic mean, the 75th percentile, and the 90th percentile of the SEAD-71 data set are greater than two times of the corresponding values for the SEDA background data set. The two highest manganese hits were detected in MW71-2 and MW71-1, upgradient of the source area in SEAD-71. MW71-2 was dry most of the time during the groundwater sampling events (i.e., 1994 and 2004 groundwater sampling). Therefore, the manganese concentration detected in MW71-2 may be overstated due to limited water volume and potentially elevated turbidity. In general, the amount of groundwater and the rate of groundwater re-charge present at the site is limited compared to other SEDA sites. Three of the four groundwater monitoring wells (MW71-1, -2, and -3) have measured saturation thickness of less than 4 feet during the 2004 sampling events.

In addition, the iron and manganese concentrations detected in a monitoring well downgradient and within the suspected source areas at SEAD-71 (i.e., MW71-4) are 0.023~0.148 ug/L and ND (reporting limit = 0.296) ~0.0081 ug/L for iron and manganese, respectively. The concentrations are below the corresponding 25th percentiles of the SEDA background data set.

It should further be noted that it is extremely unlikely that groundwater will be used as drinking water source at the site, since there is a current acceptable water supply, and the aquifer beneath the sites is not believed to be productive enough to supply the drinking water needs at the sites.

In summary, the iron and manganese concentrations in SEAD-71 groundwater are generally comparable with the SEDA background. Elevated manganese concentrations in upgradient wells may be overstated due to limited volume and potentially elevated turbidity. The iron and manganese concentrations detected in the downgradient monitoring well are consistent with the SEDA background. Therefore, iron and manganese in SEAD-71 groundwater are not identified as COCs.

6.10 COMPARISON OF CHEMICALS DETECTED IN SITE SAMPLES TO ARARS

USEPA (1989) guidance dictates that all chemicals detected in site media be compared to applicable or relevant and appropriate requirements at a site. Although a contaminant may not be identified as a COC from the risk assessment, it may exceed an ARAR and, therefore, should be evaluated in the HHRA. A discussion of the ARARs and TBCs identified for the sites is presented in **Section 2**. As discussed in **Section 2**, no ARARs were identified for soil and NYSDEC (1998 with addendum) Ambient Water Quality Standards (TOGS, 1.1.1, Class GA Standards) and Drinking Water Maximum Contaminant Levels by the National Primary Drinking Water Regulations (USEPA, 2002d) were identified as ARARs for groundwater at the sites. The NYSDEC TAGMs were identified as TBC for soil at the sites. NYSDEC Ambient Water Quality Guidance (TOGS, 1.1.1, Class GA Groundwater Guidance Values) and USEPA Secondary Drinking Water Regulations ([Code of Federal Register, Title 40, Chapter 1, Part 143](#)) were identified as TBCs for groundwater.

An evaluation of the data compared with the ARARs and TBCs is presented in **Section 4** of this report. In brief, PAH concentrations in soil exceeded the TAGM values in various sample locations. Concentrations of various metals in soil were above the TAGM values. Antimony, iron, and sodium in groundwater had concentrations above the NYS Groundwater Standards. None of these constituents were identified as COCs based on the baseline human health risk assessment. That is, the concentrations of these constituents in soil or groundwater did not result in a risk or hazard index greater than the USEPA target limits.

6.11 SEAD-59 STOCKPILES RISK ASSESSMENT FOR RESIDENTIAL RECEPTORS

Since all cleanup goals identified in the TCRA work plan (ENSR, 2002b) were not met in every stockpile sample, a risk assessment was included in the Phase II RI to evaluate whether the stockpiles pose any potential unacceptable risks to human health or the environment. The ecological risk assessment is presented in **Section 7**. The human health risk assessment results for the industrial use scenario are presented in **Appendix D** and summarized in **Table 6-12C**. This section presents a human health risk assessment for the stockpiles under a future residential use scenario. Risks via exposure to the SEAD-59 Stockpile soil and SEAD-59 groundwater were calculated for potential residential receptors (i.e., a child resident and an adult resident). The risk calculation sheets are presented in **Appendix I** and the risk results are summarized in **Table 6-16**.

As shown in **Table 6-16**, noncancer risk was slightly above the EPA limit (2 vs. 1) for the residential child exposed to SEAD-59 Stockpile soil and SEAD-59 groundwater. The elevated risk was caused by intake of SEAD-59 groundwater. As discussed in **Section 6.2.4.2**, the Army intends to place

institutional controls in the form of land use restrictions on the PID parcels (including SEAD-59 and SEAD-71) and access to or use of groundwater is proposed to be prohibited until the Class GA Groundwater Standards are met. If a groundwater use restriction were in place, the noncancer risk for the child resident with exposure to SEAD-59 Stockpile soil would be below the USEPA limit.

Total cancer risk for the residential receptor is slightly above the EPA limit (i.e., 2×10^{-4} vs. 1×10^{-4}) under the reasonable maximum exposure scenario. PAHs in stockpiles are the predominant risk contributors. When more realistic central tendency assumptions are used, the total cancer risk is below the EPA limit (i.e., 8×10^{-5} vs. 1×10^{-4}).

In summary, under a more realistic CT assumption, the stockpiles at SEAD-59 do not pose unacceptable risks to the residential receptors.

6.12 SUMMARY AND CONCLUSIONS

Risks for the three receptors identified for SEAD-59 and SEAD-71 based on the current and foreseeable future use of the sites (i.e., industrial worker, construction worker, and child trespasser/visitor) via exposure to SEAD-59 soil, SEAD-59 Stockpile soil, SEAD-59 groundwater, SEAD-71 soil, and SEAD-71 groundwater were evaluated in accordance with the USEPA RAGS. The baseline risk assessment results associated with exposure to the following three scenarios are summarized in this section: (1) SEAD-59 soil and groundwater exposure, (2) SEAD-59 Stockpile soil and SEAD-59 groundwater exposure, and (3) SEAD-71 soil and groundwater exposure.

6.12.1 SEAD-59 Soil and Groundwater Exposure

A summary of the risk assessment results for exposure to SEAD-59 soil and groundwater is presented below.

Risks Based on Reasonable Maximum Exposure Scenario - SEAD-59 Soil and Groundwater Exposure			
	Industrial Worker	Construction Worker	Child Trespasser/Child Visitor
Cancer Risk	2×10^{-5}	2×10^{-6}	2×10^{-6}
Hazard Index	3×10^{-1}	5×10^{-1}	1×10^{-1}

USEPA target limits: cancer risk of 10^{-6} – 10^{-4} ; hazard index of 1

The total cancer risks and non-cancer hazard indices based on the RME and CT scenarios for all receptors with exposure to SEAD-59 soil and SEAD-59 groundwater are within the USEPA target range (i.e., cancer risks below 10^{-4} and hazard index below 1). Therefore, the site poses no significant

risks to potential human receptors and no COCs were identified for SEAD-59 soil or SEAD-59 groundwater.

6.12.2 SEAD-59 Stockpile Soil and Groundwater Exposure

A summary of the risk assessment results for receptors exposed to SEAD-59 Stockpile soil and SEAD-59 groundwater is presented below.

Risks Based on Reasonable Maximum Exposure Scenario - SEAD-59 Stockpile Soil and Groundwater Exposure			
	Industrial Worker	Construction Worker	Child Trespasser/ Child Visitor
Cancer Risk	5×10^{-5}	3×10^{-6}	4×10^{-6}
Health Index	2×10^{-1}	5×10^{-1}	1×10^{-1}

USEPA target limits: cancer risk of 10^{-6} – 10^{-4} ; hazard index of 1

The total cancer risks and non-cancer hazard indices based on the RME and CT scenarios for all receptors with exposure to stockpile soil and SEAD-59 groundwater are within the USEPA target range. In addition, the lead level in SEAD-59 Stockpile soil does not pose a health risk to the receptors. Therefore, the stockpiles at SEAD-59 pose no significant risks to potential human receptors and no COCs were identified for SEAD-59 Stockpile soil.

6.12.3 SEAD-71 Soil and Groundwater Exposure

A summary of the risk assessment results for receptors exposed to SEAD-71 soil and SEAD-71 groundwater is presented below.

Risks Based on Reasonable Maximum Exposure Scenario - SEAD-71 Soil and Groundwater Exposure			
	Industrial Worker	Construction Worker	Child Trespasser/ Child Visitor
SEAD-71			
Cancer Risk	2×10^{-4}	1×10^{-5}	1×10^{-5}
Health Index	3×10^0	3×10^0	1×10^0
SEAD-71 Outside Fenced Area			
Cancer Risk	3×10^{-5}	3×10^{-6}	3×10^{-6}
Health Index	3×10^0	3×10^0	1×10^0

USEPA target limits: cancer risk of 10^{-6} – 10^{-4} ; hazard index of 1

The elevated PAH concentrations within the Fenced Area are not expected to be associated with any release at the site based on the following facts: 1) Elevated PAH concentrations detected in surface soil within the Fenced Area are likely caused by asphalt materials in the hard fill and the oil used in the construction of the storage area; 2) the soil underneath the pavement is not impacted by PAHs; 3) The Fenced Area is not associated with any CERCLA release. Therefore, a baseline risk assessment was also conducted for SEAD-71 outside the Fenced Area.

The total cancer risks based on the RME and CT scenarios are below the USEPA upper target limit (1×10^{-4}) for the construction worker and child trespasser. The total cancer risk based on the RME is above the USEPA upper target limit for the industrial worker (2×10^{-4} vs. 1×10^{-4}). PAHs in SEAD-71 soil are the primary COPCs contributing to the cancer risks associated with SEAD-71 soil exposure. Cancer risks based on data collected outside the Fenced Area are below the USEPA upper target limit for all receptors for both the RME and CT scenarios. Therefore, PAHs in SEAD-71 soil are not identified as COCs at the site.

The total non-cancer hazard indices based on the RME for all receptors are above or at the USEPA target limit of 1, due to groundwater intake. Risks via all exposure pathways but groundwater intake are below the USEPA target limit of 1. Iron and manganese in SEAD-71 groundwater are the primary COPCs contributing to the elevated non-cancer risks at SEAD-71. The iron and manganese concentrations in SEAD-71 groundwater are generally comparable with the SEDA background. In addition, the iron and manganese concentrations detected in the downgradient monitoring well are consistent with the SEDA background and were not identified as COCs at the site.

A lead risk characterization conducted for SEAD-71 indicates that the lead levels in SEAD-71 soil and groundwater are not expected to pose a health risk to the receptors.

6.12.4 Conclusion

The Army intends to place institutional controls in the form of land use restrictions on the PID parcel and these restrictions would eventually apply to SEAD-59 and SEAD-71. As described in the Final Record of Decision for Sites Requiring Institutional Controls in the Planned Industrial/Office Development or Warehousing Areas (Parsons, 2004), signed on September 28, 2004 by USEPA, these restrictions are as follows:

- Prohibit the development and use of property for residential housing, elementary and secondary schools, childcare facilities and playgrounds.
- Prevent access to or use of groundwater until the Class GA Groundwater Standards are met.

Based upon the planned future land use for the sites, no COCs were identified for any affected media at SEAD-59 and SEAD-71. Chemicals associated with the release at the sites do not pose a health

risk to potential receptors at the sites. The stockpile soil at SEAD-59 is suitable for uses in industrial areas as fill or grading as exposure to the stockpile soil does not pose a health risk to potential receptors at SEAD-59. Further, under a more realistic CT assumption, the stockpiles at SEAD-59 do not pose unacceptable risks to the residential receptors.

7.0 SCREENING-LEVEL ECOLOGICAL RISK ASSESSMENT

A screening-level ecological risk assessment (SLERA) was performed for the Fill Area West of Building 135 (SEAD-59) and the Alleged Paint Disposal Area (SEAD-71) at the Seneca Army Depot Activity in Romulus, New York to evaluate whether hazardous substance release has the potential to cause adverse effects to ecological resources. This section provides a description of the methodology and results. Complete risk calculation tables, including toxicity reference values and estimated exposures, are provided in **Appendix J**.

7.1 INTRODUCTION

This SLERA was conducted in accordance with several USEPA and NYSDEC guidance documents including Ecological Risk Assessment Guidance for Superfund (ERAGS): Process for Designing and Conducting Ecological Risk Assessments (USEPA, 1997c), Guidelines for Ecological Risk Assessment (USEPA, 1998b), Fish and Wildlife Impact Analysis (NYSDEC, 1994), and The Role of Screening-Level Risk Assessments and Refining Contaminants of Concern in Baseline Ecological Risk Assessments (USEPA, 2001).

The current USEPA (1997c) ecological risk assessment paradigm includes eight general steps:

1. Screening-Level Problem Formulation and Ecological Effects Evaluation (toxicity).
2. Screening-Level Exposure Estimate and Risk Calculation.
3. Baseline Risk Assessment Problem Formulation.
4. Study Design and Data Quality Objective (DQO) Process.
5. Field Verification of Sampling Design.
6. Site Investigation and Analysis Phase.
7. Risk Characterization.
8. Risk Management.

The ecological risk assessment presented in this section includes a screening-level ecological risk assessment (SLERA, Steps 1 and 2) and further refinement of COCs (Step 3.2). Step 3.2, COC refinement, was performed in accordance with the USEPA's ERAGS (1997c) and the supplemental guidance of ERAGS (USEPA, 2001). The SLERA process is summarized in **Figure 7-1**.

Upon completion of screening-level Ecological Risk Assessment (ERA) Step 2, there is a Scientific Management Decision Point (SMDP) with four possible decisions according to the ERAGS (USEPA, 1997c) and the supplemental guidance (USEPA, 2001):

- There is adequate information to conclude that ecological risks are negligible and therefore no need for remediation on the basis of ecological risks,
- The information is not adequate to make a decision at this point and the ERA process should continue to a baseline ERA,

- The information indicates a potential for adverse ecological effects, and a more thorough assessment is warranted, or
- It may be preferable to cleanup the site to the screening values for some sites of relatively small size or where the contamination has a sharply defined boundary rather than to spend time and resources determining a less conservative cleanup number.

The results of the SLERA indicate which contaminants found at the site can be eliminated from further consideration and which should be evaluated further. The refinement of COCs helps streamline the overall ERA process by considering additional components early in the baseline ERA. The results of the ecological risk assessment presented will be used to determine the need for further study. The baseline ERA if conducted will further evaluate potential or actual adverse ecological effects associated with site-related contaminants and results will be used to develop appropriate remedial measures, if required.

7.2 STEP 1A: SCREENING-LEVEL PROBLEM FORMULATION

This step considers environmental characteristics of the sites, contaminants present at the sites, potential contaminant fate and transport processes, and potential receptor categories and exposure pathways. A brief ecological characterization is provided, contaminants of potential concern are identified, and a preliminary conceptual site model is presented.

7.2.1 Environmental Setting

Information of the sites is provided in **Sections 1** through **5** of the report: general site information is presented in **Section 1**; all investigations conducted for the sites are summarized in **Sections 2** and **3**; nature and extent of impact is discussed in **Section 4**; and the fate and transport of contaminants is presented in **Section 5**. This section provides a brief introduction of SEAD-59 (**Section 7.2.1.1**) and SEAD-71 (**Section 7.2.1.2**) and a habitat and ecological community characterization for the sites (**Section 7.2.1.3**).

7.2.1.1 SEAD-59

SEAD-59 (Fill Area West of Building 135) is located in the east-central portion of SEDA (**Figure 1-3**). SEAD-59 was used for the disposal of construction debris and oily sludges. SEDA personnel had indicated that there may have been a large quantity of miscellaneous "roads and grounds" waste buried at the site. It is not known when the disposal took place.

The site encompasses an area along both sides of an unnamed dirt road and is approximately 4 acres. The area to the north contained waste piles in an area approximately 300 feet by 200 feet. This area was excavated and backfilled during the 2002 time-critical removal action (ENSR, 2002a). The area to the south is covered with vegetation. Several areas to the south of the unnamed road were excavated and backfilled during the 2002 TCRA (ENSR, 2002a).

The entire western border of the site is defined by a north-south trending drainage ditch. A drainage swale that is oriented east-to-west and parallels the railroad tracks forms the northern boundary of SEAD-59. Drainage ditches are also located on each side of the access road and are sloped from east-to-west and promote flow into the drainage ditch in the western portion of the site.

7.2.1.2 SEAD-71

SEAD-71 (i.e., the Alleged Paint Disposal Area) is located in the east-central portion of SEDA (see **Figures 1-2 and 1-4**). It is rumored that paints and/or solvents were disposed at SEAD-71 in burial pits. However, no paint or distinct disposal area was found during the previous investigations including the ESI, Phase I RI, and the 2002 TCRA.

The entire site is approximately 2 acres and bounded on the north and south by railroad tracks serving Buildings 114 and 127. A chain-link fence borders the east side of the site. The topography is relatively flat with a gentle slope to the southwest.

The Fenced Area is situated between Buildings 114 and 127 and is surrounded by a chain-link fence. A single railroad track bisects the area west to east. The area is generally paved over or covered with crushed stone and pieces of asphalt and concrete were observed on the ground surface.

West of the site is a grassy area that is interrupted by a gravel roadway, and an east-west trending SEDA railroad track that cuts through the middle of the storage areas and forms the northern boundary of the site.

7.2.1.3 Habitat and Ecological Community Characterization

Site-specific ecological evaluations of the plant and animal habitats and communities at SEADs-59 and 71 have not been conducted. Characterizations of the habitat and ecological communities present at the sites were based on general observations made during the 1994 Expanded Site Inspections, the 1997 Phase I Remedial Investigation, and the 2004 groundwater monitoring, and on the results of the ecological evaluations and assessment that have been conducted at other solid waste management units at the Depot (e.g., SEADs-4, 12, 16, 17, 25 and 26, and the Open Burning Grounds). The results and findings of the ecological characterizations completed at the other SWMUs were used along with observations made at the sites to characterize the ecological settings at SEAD-59 and SEAD-71. Key aspects of these characterizations relevant to this risk assessment are presented below.

Ecological site characterizations conducted for other SWMUs at the Depot were based on compilation of existing ecological information and on-site reconnaissance activities. The methods used to characterize the ecological resources included site-walkovers for the evaluation of existing wildlife and vegetative communities; interviews with local, state, and SEDA resource personnel; and review of environmental data obtained from previous Army reports. SEDA has a strong wildlife management program that is reviewed and approved by the New York Fish and Game Agency. The

Depot manages an annual white-tailed deer (*Odocoileus virginiana*) harvest and has constructed a large wetland called the "duck pond" in the northeastern portion of the facility to provide a habitat for migrating waterfowl.

The NYSDEC Natural Heritage Program Biological and Conservation Data System identifies no known occurrences of federal- or state-designated threatened or endangered plant or animal species within a 2-mile radius of the sites. No species of special concern are documented within the Depot property.

The only significant terrestrial resource known to occur at SEDA is the population of white-pelaged white-tailed deer, which inhabits the fenced portion of the Depot. Annual deer counting conducted at the Depot indicates that the size of the deer herd is approximately 600 animals of which approximately one-third (i.e., 200) are white-pelaged. Since the Depot is totally enclosed, the white-pelaged deer is thought to result from inbreeding within the herd. The depot maintains the herd through an annual hunting season to prevent overgrazing and starvation of the deer. The management plan of the herd is conducted by the New York State Division of Fish and Wildlife (DFW). The normal brown-pelaged deer are also common. White-tailed deer are not listed as a rare or endangered species.

Agricultural crops and deciduous forests comprise the vegetative resources used by humans near SEDA. Although no crops are grown on the Depot, farmland is the predominant land use of the surrounding private lands. Crops including corn, wheat, oats, beans and hay mixtures, are grown primarily for livestock feed. Deciduous forestland on the Depot and surrounding private lands is under active forest management. Timber and firewood are harvested from private woodlots that surround the Depot, but timber harvesting does not occur on the Depot.

Vegetation across the Depot consists of successional old field, successional shrub, and successional hardwoods. The NYSDEC Natural Heritage Program Biological and Conservation Data System identifies no known occurrences of federal- or state-designated threatened or endangered plant. No species of special concern are documented within the depot property. No rare or endangered species were observed during the site assessment.

Several wildlife species are hunted and trapped on private lands near SEDA. Game species hunted include the eastern cottontail, white-tailed deer, ruffed grouse, ring-necked pheasant and various waterfowl. Gray squirrel and wild turkey are hunted to a lesser extent. On the Depot, deer, waterfowl and small game hunting is allowed. Trapping is also permitted on the Depot.

Animals that have been identified at the depot during various ecological surveys include beaver, eastern coyote, deer, red and gray fox, eastern cottontail rabbit, muskrat, raccoon, gray squirrel, striped skunk, and the woodchuck. Birds species that have been identified include the bluejay, black-capped chickadee, American crow, mourning dove, northern flicker, ruffed grouse, ring-billed gull, red-tailed hawk, northern junco, American kestrel, white breasted nuthatch, ring-necked pheasant, American robin, eastern starling, turkey vulture, and pileated woodpecker.

There are no permanent lakes, ponds, streams or wetlands in either SEAD-59 or SEAD-71. Surface water only exists intermittently in drainage ditches; thus, it does not directly support aquatic life.

No signs of stressed or altered terrestrial biota (vegetation and wildlife species) were observed at either SEAD-59 or SEAD-71. There were no indications of unnatural die-off or stunted vegetation.

7.2.2 Preliminary Ecological Conceptual Site Model

A preliminary Conceptual Site Model was developed for the sites and presented in **Figure 7-2**. The CSM provides an overall assessment of the primary and secondary sources of contamination at the sites, and the corresponding release mechanisms and affected media. Potential sources of contamination, potentially complete exposure pathways, and ecological receptors are depicted in the CSM. Sources, release mechanisms, affected media, contaminant fate and transport, and current and future foreseeable land use of the sites are discussed in **Section 6** of the report. Potentially complete exposure pathways and potential ecological receptors are further discussed below.

A complete exposure pathway consists of a source and mechanism of contaminant release, a transport mechanism for the released contaminants, a point of contact, and a route of contaminant entry into the receptor. If any of these elements is missing, the pathway is incomplete. In addition, potential receptors were identified to allow evaluation of potentially complete pathways.

The CSM identifies exposure to SEAD-59/71 surface soils (0-2 ft bgs.) and SEAD-59 stockpile soil as a complete exposure pathway (current and future) for ecological receptors. Terrestrial pathways (soil exposure) evaluated in the SLERA are presented in **Figure 7-2**. Pathways evaluated in the SLERA include direct exposure (ingestion, dermal, and inhalation) and ingestion of contaminated biota. Various prey items such as plants and animals are consumed by receptors and serve as indirect exposure routes for contaminants. Receptors also incidentally ingest media during foraging activities. While terrestrial receptors are exposed to air, uncertainties associated with inhalation exposures to chemical stressors inhibit assessment of the impacts from exposure to this medium. Similarly, dermal exposure to chemical stressors is difficult to quantify due to a lack of toxicity data. Given these factors, the SLERA for SEAD-59/71 quantitatively assesses exposure to contaminated soil and biota through ingestion.

For most terrestrial receptors, soil exposure intervals are limited to the upper 2 feet of the soil column. For purposes of this SLERA, surface soil was defined as the 0-2 foot bgs. Surface and subsurface soil (0-4 ft bgs., hereafter referred to as total soil) may be uncovered during excavation activities in the future and therefore may result in contaminants in the soil becoming available for contact.

Ecological receptors are not directly exposed to contaminants in groundwater. As shown in **Figure 7-2**, exposure to groundwater was considered an incomplete pathway at SEAD-59/71.

There are no permanent lakes, ponds, streams, or wetlands in either SEAD-59 or SEAD-71. Drainage ditches at the sites are dry most of the time during the year and are not expected to support any balanced aquatic community. Therefore, aquatic receptors were not identified as potential receptors at the sites.

7.2.3 Identification of Ecological COPCs

Contaminants of potential concern were identified by comparing the maximum detected concentrations in each impacted medium to ecological risk-based screening values. The data used for the ecological risk assessment are the same as those used for the human health risk assessment. The data are presented in **Appendix A** of this report and the sample locations are shown in **Figure 3-1** and **Figure 3-2**. All analytical data were validated prior to inclusion in the SLERA. A discussion of the data used in both the baseline human health risk assessment and the screening-level ecological risk assessment is presented in **Section 3**. The following five soil data sets were used for the screening-level ecological risk assessment:

1. SEAD-59 surface soil (0-2 ft bgs.) data,
2. SEAD-59 surface and subsurface (0-4 ft bgs.) data,
3. SEAD-59 Stockpile data,
4. SEAD-71 surface soil (0-2 ft bgs.) data, and
5. SEAD-71 surface and subsurface (0-4 ft bgs.) data.

For each data set, the maximum detected concentration was compared with the ecological screening value. The ecological screening values were based on conservative (i.e., environmentally protective) generic values derived by various agencies. In brief, the following sources (cited in order of preference) were consulted for screening value selection:

- USEPA (2000b, 2003c, 2005b) Ecological Soil Screening Levels;
- USEPA Region III (1995) Biological Technical Assistance Group (BTAG) Screening Levels;
- USEPA Region 5 (2003) Ecological Soil Screening Levels;
- Oak Ridge National Laboratory (ORNL) Screening Benchmarks for soil and litter invertebrates and heterotrophic process (Efroymson et al., 1997a), terrestrial plants (Efroymson et al., 1997b);
- Canadian Environmental Quality Guidelines developed by the Canadian Council of Ministers of the Environment (2003); and
- Circular on Target Values and Intervention Values for Soil Remediation developed by Netherlands (2000)

Constituents that exceeded the appropriate screening values were retained as COPCs. With the exception of certain nutrients (i.e., calcium, potassium, magnesium, and sodium), constituents with no screening values available were retained as COPCs. In addition, all bioaccumulative compounds identified by USEPA (2000a) in its report Bioaccumulation Testing And Interpretation For The Purpose Of Sediment Quality Assessment as important bioaccumulative compounds were identified

as COPCs as a conservative approach, which is consistent with the ecological risk assessment guidance set forth by USEPA for the Mid-Atlantic Hazardous Site Cleanup program. Compounds (including bioaccumulative compounds) with both a very low detection frequency (i.e., <10%) and a low concentration (i.e., concentration close to the reporting limit) not related to any release at the sites were not retained as COPCs.

Results of the screening process are summarized in **Appendix J - Tables J-1A and J-1B** for SEAD-59 surface soil (0-2 ft bgs.) and total (surface soil and subsurface) soil (0-4 ft bgs.), respectively. **Table J-2** presents the screening process for SEAD-59 Stockpile soil. **Tables J-3A and J-3B** summarize the screening process for SEAD-71 surface soil (0-2 ft bgs.) and SEAD-71 total (surface and subsurface) soil (0-4 ft bgs.), respectively.

Aluminum was not retained as a COPC as USEPA recommends that aluminum be considered as a COPC only at sites where the soil pH is less than 5.5 (USEPA, 2003c). The basis for this is as follows:

- Total aluminum in soil is not correlated with toxicity to the tested plants and soil invertebrates.
- Aluminum toxicity is associated with soluble aluminum.
- Soluble aluminum and not total aluminum is associated with the uptake and bioaccumulation of aluminum from soil into plants.
- The oral toxicity of aluminum compounds in soil is dependant upon the chemical form. Insoluble aluminum compounds such as aluminum oxides are considerably less toxic compared to the soluble forms.

The soil pH of the Seneca Army Depot Activity Site is generally between 7 and 8 (Soil pH for SEADs 38, 39, & 40 were presented in Parsons, 2001 report). Consequently, aluminum was not retained as a COPC in accordance with the USEPA guidance (2003c).

Iron is essential for plant growth and is generally considered to be a micronutrient (Thompson and Troeh, 1973, cited from USEPA, 2003c). According to USEPA (2003c), currently, identifying a specific benchmark for iron in soils is difficult since iron's bioavailability to plants and resulting toxicity are dependent upon site-specific soil conditions (pH, Eh, soil-water conditions). In well-aerated soils between pH 5 and 8, the iron demand of plants is higher than the amount available (Römheld and Marschner, 1986, cited from USEPA 2003c). Because of this limitation, plants have evolved various mechanisms to enhance iron uptake (Marschner, 1986, cited from USEPA 2003c). Under these soil conditions, iron is not expected to be toxic to plants. Based on the fact that soil pH at the sites is generally between 7 and 8 and surface soil at the sites is expected to be well aerated, iron was not retained as a COPC in accordance with the USEPA guidance (2003c).

COPCs identified for soil at the sites include volatile organic compounds, polynuclear aromatic hydrocarbons, polychlorinated biphenyl, pesticides, and metals. Ecotoxicity associated with these types of contaminants includes the effects associated with direct as well as indirect exposures.

Contaminants such as PCBs have a demonstrated potential to bioaccumulate and pose risks to higher trophic level species consuming prey items in which these contaminants have accumulated. Other COPCs such as volatiles do not tend to accumulate significantly in most species and pose risks primarily through direct acute exposures.

7.2.4 Selection of Assessment Endpoints

Ecological risks should be expressed in terms of a definite endpoint, which is defined as an environmental value to be protected. Assessment endpoints are “explicit expressions of the actual environmental value that is to be protected” (USEPA 1998b). The assessment endpoints provide a transition between broad management, or policy goals, and the specific measures used in the assessment.

The proposed assessment endpoints for the SLERA are the survival and reproduction of terrestrial and wildlife populations (associated with suitable habitat) that may be affected by previous SEAD-59/71 operations. Specifically, assessment endpoints are provided for populations at two trophic levels: small mammals and ground-feeding birds and higher trophic level predators. The assessment endpoints are addressed through the survival and reproduction of mammal and bird populations at the sites. The proposed policy goals, ecological assessment endpoints, and measurement endpoints are summarized in **Table 7-1**.

7.2.5 Selection of Receptor Species

This section presents the receptor species identified for the sites. Ecological receptors are considered to include terrestrial wildlife that may reasonably be expected to reside or regularly forage in areas affected by site contaminants, given current and anticipated future site conditions. Based on current land uses at and near the Depot, ecological receptors selected are terrestrial species that may inhabit at or in the vicinity of the sites.

Guidelines considered in selecting receptors from the potentially exposed community include the following:

- relationship to the assessment endpoint;
- limited home range;
- role in local food chains;
- potential high abundance and wide distribution at the sites;
- relatively long-lived to provide chronically exposed individuals;
- sufficient toxicological information available in the literature for comparative and interpretive purposes;
- sensitivity to COPCs;
- likely current and future occurrence; and
- suitability for long-term monitoring, if necessary.

The selected receptor species have either been observed at, or are likely to be present in the vicinity of the Seneca Army Depot, given the habitat conditions at the sites.

When selecting representative receptor species, it is important that sufficient toxicological information is available in the literature on the receptor species, or a closely-related species. While the ecological communities at the individual sites may have species with desirable characteristics for use as receptor species, not all of these species have been extensively used for toxicological testing.

The receptors were also selected to represent the trophic levels and characteristics of the area being assessed. Based on available information, specific receptor species were selected to be representative of terrestrial ecological populations potentially exposed to COPCs in soil. These representative receptor species are evaluated according to the measurement endpoints selected for the site. These measurement endpoints in turn evaluate the assessment endpoints and policy goals that are ultimately evaluated in the ecological assessment.

Consideration was given to special-concern (i.e., threatened or endangered) species potentially present at the site when selecting receptor species. For Seneca Army Depot, there are no known occurrences of federal- or state-designated threatened or endangered plant or animal species within a 2-mile radius of the site. No species of special concern are documented within the Depot property.

Vegetation across the Depot consists of successional old field, successional shrub, and successional hardwoods. In the absence of special-concern plant species or sensitive plant communities at the Depot, plants were evaluated as an exposure medium (i.e., food source) for wildlife receptors, and not as individual receptors. Likewise, invertebrates such as insects were evaluated as potential indirect exposure media. Therefore, no primary producer or detritivore receptor species were identified for qualitative evaluation. The general health of these populations in areas affected by site contamination was evaluated qualitatively in the ecological site characterization. The plant assemblages representing the dominant cover types present at the site and general invertebrate group were evaluated as biotransfer media, assuming that all forage plants and soil invertebrates have the capacity to take up contaminants from soils within the root zone or from dermal contact (dust).

The terrestrial indicator species identified for the SLERA are the deer mouse and short-tailed shrew as representative first-order consumer/prey species with a relatively small foraging range, the American robin for maintained grass cover type, and red fox was evaluated for potential bioaccumulation/biomagnification of soil COPCs by a second-order consumer (higher trophic level predator). A higher trophic level bird raptor, such as a red-tailed hawk (*Buteo jamaicensis*), was initially considered as a potential receptor for this SLERA. However, the home range of a hawk, approximately 1800 acres or more (USEPA 1993b, Wildlife Exposure Factors Handbook), is much greater than the area of the sites considered in this assessment, approximately 6 acres altogether. Therefore, it is unlikely that a hawk would derive a significant portion of its diet from prey at any one of the sites evaluated. Consequently, the raptor was not further evaluated in this SLERA.

The selected species are considered to be representative of current and/or future ecological receptors at the sites and are discussed below.

Small mammal populations likely present at SEAD-59/71 include mice, shrews, and other rodents. The deer mouse (*Peromyscus maniculatus*) was selected as the resident species with the niche best met by conditions present at the sites. These are one of the vertebrate receptors most likely to be maximally exposed to contaminants in soil at the site. They represent a significant component of the food chain, feeding on seeds and berries and soil invertebrates and providing prey for predators. A second terrestrial receptor, the short-tail shrew (*Blarina brevicauda*), was also evaluated. The shrew was selected because more of its diet is derived from soil invertebrates and less is derived from seeds and berries than the deer mouse. The shrew may be directly exposed to contaminants during burrowing activities and indirectly through prey. Therefore, the shrew may be more susceptible than the mouse to the effects of COPCs that bioaccumulate in soil biota. For this reason, the shrew was considered representative of maximum exposures and was used to evaluate potential risk for small carnivorous mammals.

The American robin (*Turdus migratorius*) has been identified at SEDA during site reconnaissance visits and has been selected as an appropriate avian receptor species for soil. Birds are frequently more sensitive to specific chemicals (e.g., pesticides and phthalates) than terrestrial mammalian species. The American robin was selected because a large portion of its diet is derived from soil invertebrates that would make it more susceptible to the effects of COPCs that bioaccumulate in soil biota. Additionally, its home range is roughly comparable to those of both the deer mouse and shrew.

The red fox (*Vulpes vulpes*) has been identified at SEDA during site reconnaissance visits and has been selected as an appropriate receptor species for potential bioaccumulation/biomagnification of soil. It should be noted that the home range of a red fox, approximately 200 acres or more (USEPA 1993b, Wildlife Exposure Factors Handbook), is much greater than the area of any of the sites considered in this assessment (approximately 6 acres altogether for SEAD-59 and SEAD-71). Therefore, it is unlikely that a fox would derive a significant portion of its diet from prey at any one of the sites evaluated. Nonetheless, as a conservative approach, the red fox was identified to evaluate potential bioaccumulation/biomagnification of contaminants in soil.

7.2.6 Characterization of Exposure Pathways

Potentially completed pathways were identified for SEAD-59/71 in the CSM (**Figure 7-2**). Potential ecological receptors identified for the sites (i.e., deer mouse, American robin, short-tailed shrew, and red fox) are potentially exposed to COPCs in soil via soil ingestion and biota intake. The primary potential ecological receptor exposure interval for which characterization data were collected is surface soils (0 to 2 ft bgs.). This interval was considered appropriate for the evaluation of soil contaminant exposures to surface-foraging and shallow-burrowing wildlife and to many forage plants (e.g., grasses and forbs). Surface soil data for SEAD-59, SEAD-59 Stockpiles, and SEAD-71 are presented in **Appendix A Tables A-2A, A-6, and A-4A**, respectively. To assess both potential future site conditions and burrowing and/or deep-rooted plant impacts, the deeper soil interval (0 to 4 feet

bgs) was evaluated. Samples collected from 2-4 ft bgs. were added to the surface soil (0-2 ft bgs.) data set for the assessment of total soil (0-4 ft bgs.). **Tables 7-2A** and **7-2B** list samples collected from 2-4 ft bgs. and therefore included in the risk assessment for total soil for SEAD-59 and SEAD-71, respectively. Animals may be exposed indirectly to site-related contaminants through ingestion of biota (plants and animals) that have bioaccumulated contaminants. Because analysis of biological tissue is not proposed for these sites, the potential for exposure via completed pathways was inferred based on estimated contaminant uptake and assimilation by vegetation and prey species, and on the bioaccumulation and biomagnification properties of the contaminants.

While ecological receptors are exposed to air, uncertainties associated with inhalation exposures to chemical stressors inhibit assessment of the impacts from exposure to this medium. Similarly, dermal exposure to chemical stressors is difficult to quantify due to a lack of toxicity data. Given these factors, the dermal and inhalation exposure is not quantitatively assessed.

7.3 STEP 1B: SCREENING-LEVEL EFFECTS EVALUATION (TOXICITY)

The SLERA for mammalian and avian receptors was conducted by comparing potential exposures to COPCs to screening ecotoxicity values (SEVs). SEVs represent NOAELs and LOAELs with conversion values incorporated for toxicity information derived from studies other than no-effect or lowest-effect studies. SEVs for those analytes identified as COPCs were derived from studies reported in the literature, in the absence of site-specific data, by establishing data selection criteria such that SEVs would be as relevant as possible to assessment endpoints at the sites. In accordance with the USEPA guidance (1997c), the lowest available and appropriate toxicity values were used with modifying factors to ensure a conservative (protective) screening-level evaluation. The order of taxonomic preference when choosing SEVs was data from studies using (1) native species potentially present at the site, or (2) proxy species, such as commonly studied laboratory species. The preferred toxicity test was the lowest appropriate chronic NOAEL or LOAEL for non-lethal or reproductive effects. Values based on chronic studies were preferred. If NOAEL data were not available for a contaminant, the next preferred endpoints for SEV derivation were chronic or subchronic LOAEL, then acute endpoints including LD50 (median lethal dose) in diet, or an LC50 (median lethal concentration). SEVs were calculated using conversion to adjust the reported effects doses to a final SEV. Two factors are used to convert other types of study results into SEV's comparable to NOAEL and LOAEL studies. The factors are 1) study duration, and 2) end point (e.g. LD 50 or LC 50). These factors were multiplied together to derive the total conversion factor. The reported effects dose was divided by the total conversion factor to account for potential uncertainties in extrapolation from one endpoint to another. These factors are presented in **Appendix J, Table J-4**. For chemicals for which toxicity data were not available for the site-specific receptor, but toxicity data were available for another test organism, the toxicity data were adjusted for difference in body size for mammals. SEVs identified (NOAEL and LOAEL) for site COPCs are presented in **Appendix J, Tables J-5** and **J-6**. For COPCs without chemical-specific SEVs, the SEV for a surrogate chemical was used based on the chemical structure of the compounds and in a conservative approach. As an example, the SEV for benzo(a)pyrene, the most toxic PAH, was used as SEVs for the other PAHs without chemical-specific SEVs.

NOAEL and LOAEL SEVs and information used to derive them including test organisms, effect dose, and study duration, are summarized in **Appendix J, Tables J-5 and J-6.**

7.4 STEP 2A: SCREENING-LEVEL EXPOSURE ESTIMATE

To compare potential wildlife exposures to adverse effect levels, an estimate of contaminant exposures, expressed as daily dose ingested of contaminated food items (i.e., plant and animal) and media, was calculated. COPC daily dose ingested (expressed as the mass of COPC ingested per kilogram body weight per day) depends on the COPC concentration in plant and animal food items and media, the receptor's trophic level, the trophic level of animal food items, and the receptor's ingestion rate of each food item and media. The daily dose of COPC ingested by a receptor, considering all food items and media ingested, can be calculated from the following generic equation (USEPA, 1999b):

$$DD = \sum IR_F \cdot C_i \cdot P_i \cdot F_i + \sum IR_M \cdot C_M \cdot P_M$$

where:

DD = Daily dose of COPC ingested (mg COPC/kg BW-day)

IR_F = Receptor plant or animal food item ingestion rate (kg/kg BW-day)

C_i = COPC concentration in ith plant or animal food item (mg COPC/kg)

P_i = Proportion of ith food item that is contaminated (unitless)

F_i = Fraction of diet consisting of plant or animal food item i (unitless)

IR_M = Receptor media ingestion rate (kg/kgBW-day)

C_M = COPC concentration in media (mg/kg soil)

P_M = Proportion of ingested media that is contaminated (unitless)

Based on this algorithm, the daily dose equation for each receptor is as follows:

Deer mouse and American robin average daily exposure dose (mg/kg-day) =

$$[(C_s * SP * I_p * CF) + (C_s * BAF_i * I_{in}) + (C_s * I_s * ST)] * SFF / BW$$

Where:

C_s = Exposure Point Concentration in the appropriate soil exposure interval (mg COPC/kg dry soil);

SP = soil-to-plant uptake factor ((mg COPC/kg dry tissue)/(mg COPC/kg dry soil));

I_p = receptor-specific ingestion rate of plant material (kg wet tissue/day)

$$I_p = PDF * FR$$

where PDF = Plant dietary fraction;

and FR = Feeding rate (kg wet food/day);

CF = Dry Weight to wet weight plant matter conversion factor, 0.2 (unitless);

BAF_i = constituent-specific soil-to-invertebrate bioaccumulation factor ((mg COPC/kg wet tissue)/(mg COPC/kg dry soil));

I_{in} = receptor-specific ingestion rate of soil invertebrate (kg wet tissue/day);

$$I_{in} = FR * IDF$$

where IDF = invertebrate dietary fraction;

and FR = Feeding rate (kg wet food/day);

I_s = receptor-specific ingestion rate of soil (kg dry/day);

ST = bioavailability factor for constituents ingested in soil (assumed to be 1 for all constituents) (unitless);

SFF = site foraging frequency - ratio of site exposure area to receptor foraging range (unitless), assumed to be 1; and

BW = average adult body weight (kg).

Short-tailed shrew and red fox average daily exposure dose (mg/kg-day) =

$$[(C_s * SP * I_p * CF) + (C_s * BAF_i * I_{in}) + (C_s * BAF_a * I_a) + (C_s * I_s * ST)] * SFF / BW$$

Where:

C_s = EPC in the appropriate soil exposure interval (mg COPC /kg dry soil);

SP = soil-to-plant uptake factor ((mg COPC/kg dry tissue)/(mg COPC/kg dry soil));

I_p = receptor-specific ingestion rate for plant material (kg wet tissue/day);

$$I_p = PDF * FR$$

where PDF = Plant dietary fraction;

and FR = Feeding rate (kg wet food/day);

CF = Dry Weight to wet weight plant matter conversion factor, 0.2 (unitless);

I_{in} = receptor-specific ingestion rate for invertebrates (kg wet/day);

$$I_{in} = FR * IDF$$

where IDF = invertebrate dietary fraction;

and FR = Feeding rate (kg wet food/day);

BAF_i = constituent-specific soil-to-invertebrate bioaccumulation factor ((mg COPC/kg wet tissue)/(mg COPC/kg dry soil));

I_a = receptor-specific ingestion rate for animal material (kg wet tissue/day);

$$I_a = ADF * FR$$

where ADF = Animal dietary fraction;

and FR = Feeding rate (kg wet food/day);

BAF_a = constituent-specific soil-to-small mammal bioaccumulation factor ((mg COPC/kg wet tissue)/(mg COPC/kg dry soil));

I_s = receptor-specific ingestion rate of soil (kg dry/day);

ST = bioavailability factor for constituents ingested in soil (assumed to be 1 for all constituents) (unitless);

SFF = ratio of site exposure area to average receptor foraging range (unitless), assumed to be 1; and

BW = average adult body weight (kg).

USEPA (1993b) and USEPA (1999b) include a variety of exposure information for a number of avian and mammalian species. Data are directly available for body weights of various species. Similarly, information regarding feeding rates, and dietary composition, including incidental soil ingestion, are also available for many species. Such exposure parameters were compiled for the selected receptor species (deer mouse, American robin, short-tailed shrew, and red fox). Feeding rates for receptors were based upon USEPA (1999b) or allometric equations presented in Nagy (1999). Literature values for diet fraction and body weights were taken from USEPA (1999b) and USEPA (1993b). For the screening-level exposure estimate, site foraging frequency factors for all receptors were assigned as 1, in accordance with the USEPA (1997c) guidance. That is, all receptors were assumed to be exposed 100% of the time to the COPCs at the sites. This is a very conservative assumption as most receptors will spend at least part of the time outside of the site boundaries, either by having a home range larger than the site area, seasonal migration patterns, and/or winter dormancy periods. As an example, the red fox has much larger foraging range compared to the size of SEAD-59/71 (i.e., over 200 acres vs. approximately 6 acres). This factor will be considered in the COC refinement step (**Section 7.6**).

The soil-to-plant uptake factors and soil-to-soil invertebrate uptake factors were obtained from the USEPA (1999b) Screening Level Ecological Risk Assessment Protocol for Hazardous Waste Combustion Facilities. Small mammal bioaccumulation factors were from published literature or were calculated based on chemical-specific partitioning coefficients from the literature.

The EPC evaluated for each soil COPC was determined based on the maximum detected concentration, in accordance with the USEPA (1997c) guidance. The EPCs are summarized in **Table J-9A** through **Table J-9D** in **Appendix J**.

Exposure factors and uptake parameters, the detailed exposure calculation, and the results are presented in **Appendix J, Tables J-8 to J-13**.

7.5 STEP 2B: SCREENING-LEVEL RISK CALCULATION

For wildlife receptors, the risk calculation step uses the results of the wildlife exposure and toxicity effects assessments to calculate a hazard quotient for each COPC. An HQ is a ratio of the estimated exposure dose (for mammal and bird receptors) of a contaminant to the SEV. Generally, the greater this ratio, or quotient, the greater the likelihood of an effect. An HQ less than one indicates that the contaminant alone is unlikely to cause adverse ecological effects. Because conservative (i.e., health protective) estimates of potential chronic exposures and toxicity were used, screening-level HQs tend to overestimate actual risks. Cumulative effects of COPCs were not quantitatively evaluated in this SLERA. For metals, there is no evidence of clearly additive effects in ecological systems. For PAHs, the uncertainty associated with not addressing the cumulative effects is discussed in the uncertainty section (**Section 7.5.2**). Calculated HQs for mammal and bird receptors are reviewed below.

For mammal receptors, HQs were calculated based on the NOAEL SEVs, the maximum detected concentrations for the COPCs, and a site foraging frequency factor of 100% in accordance with the USEPA (1997c) guidance. A site foraging frequency factor of 100% assumes the receptor is present at the site and does not forage or range beyond the boundaries of the site being evaluated. This is a very conservative assumption as most receptors will spend at least part of the time outside of the site boundaries, either by having a home range larger than the site area, seasonal migration patterns, and/or winter dormancy periods.

7.5.1 Summary of Risk Results and Preliminary COC Identification

HQ results for the identified receptors based on the maximum detected concentrations for the COPCs and the NOAEL SEVs are presented in **Tables J-14A, J-14B, and J-14C** for SEAD-59 soil, SEAD-59 Stockpile soil, and SEAD-71 soil, respectively. The results are discussed in the following subsections for potential risks associated with SEAD-59 soil, SEAD-59 Stockpile soil, and SEAD-71 soil, respectively. All COPCs with HQs greater than or equal to one based on the maximum detected concentrations and the NOAEL SEVs were identified as preliminary COCs. A further discussion of the preliminary COCs and a refinement of the COCs is presented in **Section 7.6**.

7.5.1.1 SEAD-59 Soil

HQ results for the identified receptors exposed to COPCs in SEAD-59 soil based on the maximum detected concentrations for the COPCs and the NOAEL SEVs are presented in **Table J-14A**. Estimated exposures based on the maximum detected concentrations of the COPCs in 0-2 ft bgs. soil and 0-4 ft bgs. soil at SEAD-59 for the deer mouse, American robin, short-tailed shrew, and red fox are presented in **Tables J-10A, J-11A, J-12A, and J-13A**, respectively.

Soil COPCs with the maximum detected concentrations that generated HQs based on the NOAEL SEVs greater than or equal to one for the identified receptors include one PAH (phenanthrene), two pesticides (4,4'-DDE and 4,4'-DDT), and several metals (antimony, arsenic, cadmium, cobalt, lead,

silver, thallium, and vanadium). These COPCs were identified as preliminary COCs in SEAD-59 soil and were further evaluated in **Section 7.6**.

HQs based on the NOAEL SEVs are below one for the avian receptor (American robin) exposed to all COPCs in SEAD-59 soil with the exception of 4,4'-DDE, 4,4'-DDT, and lead. The HQ for the American robin exposed to 4,4'-DDT in SEAD-59 soil is approximately 700. The HQ for the American robin exposed to 4,4'-DDE is slightly above one at two and the HQ for the American robin exposed to lead is at one. HQs based on the NOAEL SEVs are below 1 for the high trophic level mammal (red fox) exposed to all COPCs in SEAD-59 soil with the exception of antimony. A further discussion of the impacts by antimony to the red fox and 4,4'-DDT, 4,4'-DDE, and lead to the American robin is provided in **Section 7.6**.

Table J-14A indicates that exposure to the maximum detected concentrations of 4,4'-DDT and three metals (antimony, arsenic, and vanadium) in SEAD-59 soil by the deer mouse results HQs greater than one based on the NOAEL SEVs. The HQ associated with exposure to the maximum detected concentrations of DDE, cadmium, and cobalt in soil is at one for the deer mouse.

Exposure to the maximum detected concentrations of 4,4'-DDT and five metals (antimony, arsenic, cobalt, thallium, and vanadium) in SEAD-59 soil by the short-tailed shrew results HQs greater than one based on the NOAEL SEVs. The HQs associated with exposure to the maximum detected concentration of phenanthrene, 4,4'-DDE, silver, and cadmium in soil are at one for the short-tailed shrew. HQs resulted from the maximum detected concentrations of PAHs in SEAD-59 soil are all below 1 for all receptors except that the HQs for the short-tailed shrew exposed to phenanthrene in SEAD-59 are at 1. Therefore, PAHs in SEAD-59 soil are unlikely to cause adverse ecological effects.

7.5.1.2 SEAD-59 Stockpile Soil

HQ results for the identified receptors exposed to COPCs in SEAD-59 Stockpile soil based on the maximum detected concentrations for the COPCs and the NOAEL SEVs are presented in **Table J-14B**. Estimated exposures based on the maximum detected concentrations of the COPCs in SEAD-59 Stockpile soil for the deer mouse, American robin, short-tailed shrew, and red fox are presented in **Tables J-10B, J-11B, J-12B, and J-13B**, respectively.

Soil COPCs with the maximum detected concentrations that generated HQs based on the NOAEL SEVs greater than or equal to one for the identified receptors include one PAH (phenanthrene), one pesticide (4,4'-DDT), and several metals (antimony, arsenic, lead, silver, and vanadium). These COPCs were identified as preliminary COCs in SEAD-59 Stockpile soil and were further evaluated in **Section 7.6**.

HQs based on the NOAEL SEVs are below 1 for the avian receptor American robin exposed to all COPCs in SEAD-59 Stockpile soil with the exception of 4,4'-DDT and lead. The HQs for the

American robin exposed to 4,4'-DDT and lead are 99 and 10, respectively. A further discussion of the impacts by 4,4'-DDT and lead to the American robin is provided in **Section 7.6**.

HQs based on the NOAEL SEVs are below 1 for the high trophic level mammal (red fox) exposed to all COPCs in SEAD-59 Stockpile soil with the exception of antimony. The HQ for the red fox exposed to antimony is slightly above one at two. Therefore, the high trophic level mammals overall are unlikely impacted by the SEAD-59 Stockpile soil. A further discussion of the impacts by antimony to the red fox is provided in **Section 7.6**.

Table J-14B indicates that exposure to the maximum detected concentrations of four metals (antimony, arsenic, lead, and vanadium) in SEAD-59 Stockpile soil by the deer mouse results HQs greater than one based on the NOAEL SEVs. The HQ associated with exposure to the maximum detected concentration of silver in stockpile soil is at one for the deer mouse.

Exposure to the maximum detected concentrations of five metals (antimony, arsenic, lead, silver, and vanadium) in SEAD-59 Stockpile soil by the short-tailed shrew results in HQs greater than one based on the NOAEL SEVs. The HQ associated with exposure to the maximum detected concentration of pyrene in Stockpile soil is at one for the short-tailed shrew. HQs resulted from the maximum detected concentrations of all other PAHs in SEAD-59 Stockpile soil are all below 1 for all receptors. Therefore, PAHs in SEAD-59 Stockpile soil are unlikely to cause adverse ecological effects.

7.5.1.3 SEAD-71 Soil

HQ results for the identified receptors exposed to COPCs in SEAD-71 soil based on the maximum detected concentrations for the COPCs and the NOAEL SEVs are presented in **Table J-14C**. Estimated exposures based on the maximum detected concentrations of the COPCs in 0-2 ft bgs. soil and 0-4 ft bgs. soil at SEAD-71 for the deer mouse, American robin, short-tailed shrew, and red fox are presented in **Tables J-10C, J-11C, J-12C, and J-13C**, respectively.

Soil COPCs with the maximum detected concentrations that generated HQs based on the NOAEL SEVs greater than or equal to one for the identified receptors include PAHs, pesticides, and metals.

As discussed in Section 6, the elevated PAH concentrations in surface soil within the Fenced Area at SEAD-71 are not associated with any release at the site. In addition, the Fenced Area is paved and therefore is not expected to support growth of plants or soil invertebrates. Therefore, a screening level ecological risk assessment was conducted for SEAD-71 by using all soil data outside the Fenced Area. Potential impacts to plants and soil invertebrates are presented in **Table J-10D**. HQ results for the identified receptors exposed to COPCs in SEAD-71 soil outside the Fenced Area are presented in **Table J-14D**. Estimated exposures based on the maximum detected concentrations of the COPCs in 0-2 ft bgs. soil and 0-4 ft bgs. soil at SEAD-71 outside the Fence Area for the deer mouse, American robin, short-tailed shrew, and red fox are presented in **Tables J-10D, J-11D, J-12D, and J-13D**, respectively.

As shown in **Table J-14D**, COPCs with the maximum detected concentrations that generated HQs based on the NOAEL SEVs greater than or equal to one for the identified receptors include six PAHs (benzo(a)anthracene, benzo(a)pyrene, benzo(b)fluoranthene, chrysene, phenanthrene, and pyrene), one pesticide (4,4'-DDT), and six metals (antimony, arsenic, lead, thallium, vanadium, and zinc) in SEAD-71 soil outside the Fenced Area. These COPCs were identified as preliminary COCs in SEAD-71 soil and were further evaluated in **Section 7.6**.

HQs based on the NOAEL SEVs are below 1 for the high trophic level mammal (red fox) exposed to all COPCs in SEAD-59. Therefore, the high trophic level mammals are unlikely impacted by the soil outside the Fenced Area at SEAD-71.

HQs based on the NOAEL SEVs are below 1 for the avian receptor (American robin) exposed to all COPCs in soil outside the Fenced Area at SEAD-71 with the exception of 4,4'-DDT, lead, and zinc.

Deer mouse exposure to the maximum detected concentrations of phenanthrene, pyrene, lead, and zinc in soil outside the Fenced Area results in a slightly elevated HQ at 2. In addition, **Table J-14D** indicates that HQs for the deer mouse exposed to antimony, arsenic, and vanadium in SEAD-71 soil outside the Fenced Area are greater than one based on the NOAEL SEVs. The HQs associated with exposure to the maximum detected concentration of thallium in soil outside the Fenced Area is at one for the deer mouse. HQs for the deer mouse exposed to the other COPCs are below one.

Exposure to the maximum detected concentrations of two PAHs (phenanthrene and pyrene) and six metals (antimony, arsenic, lead, thallium, vanadium, and zinc) in SEAD-71 soil outside the Fenced Area by the short-tailed shrew results HQs greater than one based on the NOAEL SEVs. The HQs associated with exposure to the maximum detected concentrations of four PAHs (benzo(a)anthracene, benzo(a)pyrene, benzo(b)fluoranthene, and chrysene) are at one for the short-tailed shrew.

7.5.2 Uncertainties for ERA Steps 1 and 2

For this aspect of the SLERA, a qualitative analysis was made of the uncertainties associated with the various components of the assessment, including the problem formulation and screening of contaminants and criteria used, toxicity and exposure characterization, and characterization of risk. This analysis identifies the potential magnitude of underestimating or overestimating the adverse effects to ecological receptors.

7.5.2.1 Uncertainty in Screening-Level Problem Formulation

The preliminary problem formulation step of the SLERA may have some degree of uncertainty regarding the selection of COPCs, identification of potential exposure pathways, and the selection of receptor species.

The assessment and measurement endpoints were selected according to the USEPA guidance (1997c and 1998b). The screening criteria used for the selection of ecological COPCs were derived from various sources. Most of these criteria are recommended for screening of site contaminants and are developed by the USEPA and USEPA various regions. Uncertainties associated with the sources and derivation of the criteria could possibly underestimate or overestimate the number of site COPCs.

In order to determine the potential exposure to ecological receptors to site-related constituents, the presence of constituents in environmental media must first be established. The magnitude at which these constituents are present also greatly influences resulting exposure estimates. The SLERA was conducted based on all data available for the sites. As discussed in **Section 6.8**, the size of the soil samples and the biased sampling approach indicate the uncertainty associated with site characterization is low. In addition, uncertainty in contaminant identification is considered low because generally full suite of Contract Laboratory program target compounds including VOCs, semivolatile organic compounds, PCBs, pesticides, and metals were analyzed for the samples. Reasonable certainty also is assumed because of the sample data validation and quality assurance/quality control procedures applied to sample analysis and data evaluation.

Receptors were selected based on several factors, including their known or potential occurrence in the vicinity of the Seneca Army Depot, as well as their level of sensitivity to contaminants. These decisions are based on best professional judgment and recommendations by USEPA (1997c) and USEPA (1999b) regarding wildlife exposure parameters and calculations. Limitations regarding the determination of receptor species include the availability of exposure and toxicity information, abundance versus sensitivity, and ecological relevance. The potential for overestimation or underestimation exists when using receptor species and extrapolating calculated risks to other species within that trophic level.

7.5.2.2 Uncertainty in Screening-Level Ecological Effect Evaluation

The evaluation of ecological effects involves the derivation of ecological SEVs for comparison to the calculated exposures (e.g., daily dose). Because toxicity information is limited for many chemicals, SEVs from similar or related chemicals were sometimes used. The use of surrogate toxicity values may underestimate or overestimate risk. For other chemicals, analytical results may not distinguish between different isomers or forms of a chemical although available toxicity information does, or vice versa. The absence of isomer specific toxicity values or isomer specific analytical data for some chemicals may tend to overestimate or underestimate risks. The SEV selection process may overestimate risk since overall the most conservative (and scientifically defensible) SEV is chosen rather than a range of or median SEV(s). In addition, the toxicity values used are chemical-specific and are incorporated into the SEV by use of conversion factors. For example, a conversion factor may be applied for the extrapolation from LD50 to chronic exposures. The use of conversion factors may overestimate or underestimate risk for a particular COPC. Toxicity studies for species other than the receptor species of concern are often used in the development of SEVs. The use of related species

to estimate toxicity to a representative receptor species may overestimate or underestimate risk due to different species sensitivity to particular toxicants.

SEVs may not be available for some COPCs, thereby precluding their inclusion in the quantitative risk estimates. The resulting risk estimates will not include the chemical-specific risks from these chemicals and therefore, may underestimate risk. For this assessment, toxicity data were available for all of the identified COPCs with the exception of antimony. No SEV of antimony was identified for avian receptors. A further evaluation of antimony in soil is presented in **Section 7.6**.

For many COPCs, especially metals, the form of the compound has a direct affect on its toxicity. For this screening ERA, the most toxic form of the COPC was utilized to derive the SEVs. NOAELs or estimated NOAELs were always utilized as the SEVs for the screening level ERA. However, LOAELs may be better for estimating risk since LOAELs are the lowest concentrations at which a receptor demonstrates adverse effects. Thus, HQs can be generated utilizing LOAELs in lieu of NOAELs to represent the concentration at which receptors start showing effects due to exposure to the COPCs.

7.5.2.3 Uncertainty in Screening-Level Exposure Assessment

Factors that can contribute to uncertainty in the exposure assessment include identification and evaluation of exposure pathways, intake parameters, and EPCs.

The identification of potential exposure pathways and receptors was based on site-specific reasonable current use and future ecological habitat. Site-specific receptors were identified to the extent possible and exposure parameters tailored to these receptors to minimize uncertainty in the defined scenarios and exposure assessments.

Values assumed for exposure parameters (e.g., feeding rates and dietary intake) used in calculations for intakes were based on Nagy (1999), USEPA (1993b), and USEPA (1997c, 1999b) guidance. These assumptions may result in underestimating or overestimating the intakes calculated for specific receptors, depending on the accuracy of the assumptions relative to actual site conditions and uses. Since conservative assumptions were used to select intake rates, bioaccumulation factors and site utilization factors, the risk to the receptors is generally expected to be overestimated.

Exposure and toxicity information are generally not available for dermal or inhalation exposure; hence, the lack of quantitative evaluation may underestimate risk. On-site exposure of COPCs to receptors may occur via dermal and inhalation pathways. Although intake of contaminants from these additional pathways may occur, these exposure routes are expected to be negligible compared to exposure via ingestion routes. Therefore, the impact to the overall contaminant exposure is expected to be minor.

Another source of exposure estimation uncertainty is that contamination is assumed to remain constant over time. Fate and transport mechanisms, which would result in the degradation and loss of some COPCs from the environment, may not be considered in the exposure evaluation for ecological receptors. In addition, the use of the maximum detected concentration as EPC may overestimate risk since the receptor is actually exposed to a broader range of contaminant concentrations rather than the maximum detected concentrations. Thus, actual risks may be lower than those presented in the assessment.

Estimations of uptake and retention of COPCs using BAFs often do not account for the depuration of COPCs from the organism's system over time. BAFs are also reflective of the most contaminated source of the organism's diet fraction. For example, a receptor's invertebrate diet may consist largely of insects, yet for most COPCs, the invertebrate BAF used was reflective of earthworm bioaccumulation since the earthworm BAFs are generally more conservative than other invertebrate BAFs.

Metals in environmental media, particularly solid matrices, are frequently bound to particles or complexed with other elements, making them less available to biological organisms. Metals such as lead can react with anions in water, such as hydroxides, carbonates, sulfates, and phosphates that have low water solubilities and will precipitate out of the water column, or occur as sorbed ions or surface coatings on sediment mineral particles (ATSDR, 2003). Zinc is capable of forming complexes with a variety of organic and inorganic complexing groups. Sorption is the dominant reaction of zinc, resulting in the enrichment of zinc in suspended and bed sediments (ATSDR, 2003). These complexes would limit the bioavailability of chemicals of potential ecological concern to receptors. Extraction and analysis of total metals in samples does not differentiate between the bioavailable and non-bioavailable fraction (complexed with other compounds present in bulk sediment samples) of metals in soil. This would result in an overestimation of hazard for the ecological receptors exposed to metals in soil.

Biota uptake is a major exposure pathway evaluated in the SLERA. The USEPA recommended food chain models have been used in the analysis. However, no biota sampling has been conducted to validate the model. If a further evaluation, i.e., a baseline ecological risk assessment, is warranted, a biota sampling would provide site-specific information and improve the understanding of the ecological impacts to the site habitat.

A conservative site foraging frequency factor of 1 was used for all mammalian and avian receptors. A site utilization factor of 100% assumes the receptor is present at the site and does not forage or range beyond the boundaries of the site being evaluated. This is a very conservative assumption as most receptors will spend at least part of the time outside of the site boundaries, either by having a home range larger than the site area, seasonal migration patterns, and/or winter dormancy periods.

7.5.2.4 Uncertainty in Screening-Level Risk Characterization

The screening level risk characterization step may result in some degree of uncertainty for the SLERA results. Uncertainties in the risk characterization are compounded under the assumption of dose additivity or nonadditivity for multiple substance exposure. For this assessment, it was assumed that the potential toxic effects of the COPCs were non-additive. This assumption may result in the underestimation of risk since concurrent exposure to several contaminants might have synergistic toxic effects. The risk characterization of metals does not include additive effects since there is no evidence of clearly additive effects in ecological systems. For PAHs, although the sum of HQs exceeded one for deer mouse and short-tailed shrew, the SEVs were based on the SEV for benzo(a)pyrene, the most toxic chemical among the PAHs. In addition, the sum of HQs would be below one if LOAEL SEVs were used. Therefore, PAHs in soil are not expected to pose significant risk to the environment.

In summary, identification and evaluation of exposure pathways, intake parameters, and EPCs can all contribute to uncertainty in the SLERA. Overall, the HQs calculated from the conservative SEVs, the maximum detection exposure concentrations, and 100% site utilization factor for mammals were intended to provide confidence that the risk assessment yields reasonably conservative estimates of the potential risk of adverse ecological effects on the assessment endpoints.

7.6 FURTHER REFINEMENT OF CONTAMINANTS OF CONCERN

For the screening level ERA, NOAEL toxicity values, the maximum detected COPC concentrations, and default exposure assumptions were used to calculate screening level HQs. Due to the conservative nature of these assumptions, additional evaluation is required to refine the contaminants of concern. The refinement of COCs streamlines the overall ERA process to determine if further evaluation is warranted. This section presents the results of further refinement of contaminants of concern conducted in accordance with the USEPA's ERAGS supplemental guidance (USEPA, 2001).

Lines of evidence (COC refinement) evaluated include:

- overall conservative evaluation of ecological risks in Steps 1 and 2;
- risk results based on reasonable site average concentrations and/or LOAEL SEVs;
- sufficiency and quality of literature toxicity data and experimental designs;
- site risk relative to background risk;
- size of site relative to foraging area of receptors;
- strength of cause/effect relationships; and
- quality of habitat for receptors.

Alternative toxicity values and mean exposures based on mean concentrations were considered for determining potential contaminants of concern. Utilizing the mean concentration instead of the maximum concentration presents a more realistic approach to evaluate how a receptor may come into contact with a COPC. The receptor is likely to range over the entire site and not be continuously

exposed to the maximum concentration at all times. Thus, the mean is more representative of the actual exposure concentration for a receptor to contact on a continual basis. This additional risk characterization (i.e., calculating alternative risks based on LOAEL SEV toxicity values and/or mean concentrations) performed as part of the ERA Step 3 is discussed in **Sections 7.6.2** through **7.6.4** for SEAD-59 soil, SEAD-59 Stockpile soil, and SEAD-71 soil, respectively and can be used to refine the COCs and support a decision for either additional evaluation or no further evaluation of environmental risk.

7.6.1 Overall Conservative Evaluation of Ecological Risks in Steps 1 and 2

In accordance with the USEPA ERAGS, this SLERA was conducted using highly conservative assumptions. Therefore, the SLERA in general leads to an overestimation of the risks to the ecosystem. This section discusses three major parameters for which conservative estimations were used: the relative bioavailability, the site foraging frequency factor, and the NOAEL/LOAEL multiplier.

Relative Bioavailability

Although the relative bioavailability of contaminants at the sites was assumed to be 100 percent for the SLERA, contaminants in environmental media are generally less available to biological organisms compared with the same contaminants in the experimental medium (i.e., diet, water, etc.). For example, most of the soil COPCs identified in the initial screening level ERA are PAHs and metals. The following factors should be considered in the refinement of PAH and metal COCs:

- Metals in soil are frequently bound to particles or complexed with other elements, making them less available to biological organisms. These tendencies would tend to limit the bioavailability of metals to ecological receptors.
- Metal toxicity is generally associated with the soluble fraction.
- Soluble metal, not total metal, is associated with the uptake and bioaccumulation of metal from soil into plants.
- The oral toxicity of metal compounds in soil is dependant upon the chemical form. Insoluble compounds are considerably less toxic compared to the soluble forms. The soil pH observed at the site (7 to 8) favors formation of insoluble fractions.
- Although bioaccumulation has been observed for some metals (e.g., Cd, Pb, etc.), biomagnification is not reported for these metals.

Although there are some interaction effects between certain metals (for example, lead may enhance cadmium absorption; ATSDR, 1999), the overall conservative assumptions (100% bioavailability) tend to overestimate the risks.

Over time (e.g., months or years) an organic compound can enter the microscopic pores on the surface of soil particles and become sequestered into the solid portion by binding tightly to the

organic content in soil, thereby making it less bioavailable (Alexander, 2000). Extensive scientific data now exist to support the concepts that the longer the chemicals remain in soil, (1) the less readily they are removed by solvents, including water, (2) the less available they become to microorganisms, (3) the less toxic they become to organisms such as earthworms, and (4) the less they are ingested by organisms such as earthworms. This reduction in availability of the chemicals reduces the risk associated with their presence in the soil (GRI, 1997, as cited in Nakles et al., 2002). For example, the toxicity of DDT declined by 25~80% for animals (including fruit flies, houseflies, and cockroaches) after 90 days of aging (Nakles, et al., 2002). The assumption that COPCs are completely bioavailable, given the age and history of the site, is likely to overestimate systemic absorption of these COPCs.

Chemical-specific bioavailability factors are discussed in the following sections where appropriate on a case-by-case basis.

Site Foraging Frequency Factor

The site foraging frequency factors (or area-use factors) were assumed to be one for the mammalian receptors at the sites. That is, the receptors were assumed to be present at the site and do not forage or range beyond the boundaries of the site being evaluated. This is a very conservative assumption as most receptors will spend at least part of the time outside of the site boundaries, either by having a home range larger than the site area, seasonal migration patterns, and/or winter dormancy periods. As an example, the red fox has much larger foraging range compared to the size of SEAD-59/71 (i.e., over 200 acres vs. approximately 6 acres). A site foraging frequency factor close to 0.03 would be more appropriate for the red fox.

For the avian receptor, a site foraging frequency factor of 100% was assumed. This is an overly conservative assumption. American robins in the northern portions of the range that complete full migration leave the breeding grounds from mid-August through mid-October and arrive on their northern breeding grounds in April and May (Whitefish Point Bird Observatory, 2005). Although there are partially migratory populations and sedentary populations, during winter these populations are not likely to be exposed to soil or earthworms, the predominant contaminated diet items contributing to the total daily dose of contaminants. In addition, only part of the site has been impacted by the contaminants. Therefore, a site foraging frequency factor of 0.5 would be a more appropriate estimate for the American robin and this number was used in this COC refinement step to provide more realistic estimate of potential risks to the American robin.

NOAEL/LOAEL Multiplier

A NOAEL is preferred to a LOAEL as a screening ecotoxicity value to ensure that risk is not underestimated (USEPA, 1997c). However, NOAELs currently are not available for many groups of organisms and many chemicals. When a LOAEL value, but not a NOAEL value, is available from the literature, a standard practice is to multiply the LOAEL by a NOAEL/LOAEL multiplier, 0.1, and to use the product as the NOAEL for the screening evaluation. Although a NOAEL/LOAEL

multiplier of 0.1 was used, the true NOAEL may be only slightly lower than the experimental LOAEL, particularly if the observed effect is of low severity (Sample et al., 1996). The data review referred to in the ERAGS that is used to support the use of 0.1 as the NOAEL/LOAEL multiplier indicates that 96% of chemicals included in the review had a NOAEL/LOAEL multiplier no less than 0.2. Therefore, using a default NOAEL/LOAEL multiplier of 0.1 may result in an overestimation of the HQs.

7.6.2 Identification of Soil COCs

This section presents a discussion of the preliminary COCs identified for the sites and summarizes the final COCs identified for the sites.

7.6.2.1 SEAD-59 Soil

Based on the calculated risk estimates for the screening level ERA, one PAH (phenanthrene), two pesticides (4,4'-DDE and 4,4'-DDT), and several metals (antimony, arsenic, cadmium, cobalt, lead, silver, thallium, and vanadium) in SEAD-59 soil were identified as preliminary COCs as the associated HQs were at least one for one or more receptors (see **Table J-14A**). This section presents further evaluation of the preliminary COCs identified in SEAD-59 soil based on the SLERA results. Upon the refinement described in this section, no COC was identified as soil COC for SEAD-59 soil.

Phenanthrene

For phenanthrene, the HQs for the short-tailed shrew exposed to surface and total soil are at one and the HQs for all the other receptors are below one. The HQs for the shrew were based on the maximum detected concentration and the NOAEL SEV derived from the LOAEL value for benzo(a)pyrene. The alternative HQs based on the maximum detected concentration and the LOAEL value for benzo(a)pyrene are 0.1 (as shown in **Table J-15A**). The alternative HQs based on the NOAEL SEV and the mean concentration of phenanthrene in surface and total soil for the shrew are 0.04 (as shown in **Table J-17A**). The alternative HQs based on the LOAEL SEV and the mean concentration of phenanthrene in surface and total soil for the shrew are 0.004 (as shown in **Table J-18A**). Due to the fact that the HQs based on the SLERA are at one for the shrew and all the alternative HQs are below one and the fact that SLERA results are based on conservative assumptions (e.g., SEV for benzo(a)pyrene was used for phenanthrene), phenanthrene is not expected to have any significant impacts on ecological receptors at the site and was not identified as a COC.

4,4'-DDE

For 4,4'-DDE, the HQs for the American robin exposed to surface and total soil are slightly above one at two. The HQs for the short-tailed shrew exposed to surface and total soil are at one, the HQs for the deer mouse exposed to surface and total soil are at one, and the HQs for all the other receptors are below one. The HQs were based on the maximum detected concentration and the NOAEL SEV.

The alternative HQs based on the maximum detected concentration and the LOAEL SEV are 0.2 for the American robin and 0.1 for the shrew (as shown in **Table J-15A**). The alternative HQs based on the NOAEL SEV and the mean concentration of 4,4'-DDE in surface and total soil are 0.01 for the American robin and 0.02 for the shrew (as shown in **Table J-17A**). The alternative HQs based on the LOAEL SEV and the mean concentration of 4,4'-DDE in surface and total soil are 0.001 for the American robin and 0.002 for the shrew (as shown in **Table J-18A**). Due to the fact that the HQs based on the SLERA are slightly above one or at one for the American robin and shrew and all the alternative HQs are below one and the fact that SLERA results are based on conservative assumptions, 4,4'-DDE is not expected to have any significant impacts on ecological receptors at the site and was not identified as a COC.

4,4'-DDT

For 4,4'-DDT, the HQs for the deer mouse and short-tailed shrew exposed to surface and total soil are slightly above one (1.8 and 2.6 for the deer mouse and short-tailed shrew, respectively). The HQs for the American robin are above one at 350. The HQs were based on the maximum detected concentration and the NOAEL SEVs. The NOAEL SEV for the American robin was based on the LOAEL value for brown pelican. It should be noted that the NOAEL SEVs identified for the SLERA may overstate potential risks associated with 4,4'-DDT exposure. As an example, the toxicity reference values adopted by Navy/USEPA Region 9 BTAG and recommended by the California Department of Toxic Substances Control Human and Ecological Risk Division (HERD) range from 0.8 mg/kg-day to 16 mg/kg-day for mammals and from 0.009 mg/kg-day to 1.5 mg/kg-day for birds. The NOAEL SEVs identified for this SLERA ranged from 0.7 mg/kg-day to 1 mg/kg-day for mammals and was 0.0028 mg/kg-day for birds. Therefore, the NOAEL SEVs identified for 4,4'-DDT are conservative estimates and may overstate potential risks. The alternative HQs based on the maximum detected concentration and the LOAEL SEV are 0.4, 40, and 0.5, respectively for the deer mouse, American robin, and short-tailed shrew (as shown in **Table J-15A**). The alternative HQs based on the NOAEL SEV and the mean concentration of 4,4'-DDT in surface and total soil are 0.02 and 0.03 for the deer mouse and shrew, respectively (as shown in **Table J-17A**). The alternative HQs based on the NOAEL SEV and the mean concentration of 4,4'-DDT for the American robin are 5 and 4, respectively for exposure to surface and total soil (as shown in **Table J-17A**). The alternative HQs based on the LOAEL SEV and the mean concentration of 4,4'-DDT in surface and total soil are below one for all receptors (0.004-0.0005 for deer mouse, 0.4-0.5 for the American robin, and 0.007 for the short-tailed shrew as shown in **Table J-18A**). Due to the fact that the alternative HQs based on the LOAEL SEV and the mean concentration of 4,4'-DDT are below one for all receptors and the fact that SLERA results are based on conservative assumptions (e.g., conservative SEVs), 4,4'-DDT is not expected to have any significant impacts on ecological receptors at the site and was not identified as a COC.

Antimony and Arsenic

For antimony and arsenic, the HQs for the deer mouse and short-tailed shrew exposed to surface and total soil are above one and the HQs for all the other receptors are below one. An antimony SEV was

not identified for birds and therefore, risks to the American robin were not quantified for exposure to antimony. The HQs for the deer mouse and shrew were based on the maximum detected concentration and the NOAEL SEVs. The SEVs for antimony were based on the LOAEL value from a drinking water study, and the SEVs for arsenic were based on a drinking water (plus incidental food intake) study. Metals tend to be more bioavailable in their soluble forms while less bioavailable in soil. Antimony has been shown to adsorb strongly to most soils with a median percent adsorption of 93% and as much as 100% adsorption in several soil types (ATSDR, 1992). Numerous studies of the oral bioavailability of soil-bound arsenic have been conducted (reviewed in Valberg *et al.*, 1997; Ruby *et al.*, 1999). The mean bioavailability of arsenic in soil ranged from 0.03 to 0.48. Therefore, bioavailability of antimony and arsenic is expected to be much lower than that of the toxicity studies from which the SEVs were identified. Further, the alternative HQs based on the LOAEL SEVs and the mean concentration of antimony and arsenic in surface and total soil for the deer mouse and shrew are below one as shown in **Table J-18A**. Due to the fact that the alternative HQs based on the LOAEL SEVs and the mean concentrations of antimony and arsenic are below one and the fact that SLERA results are based on conservative assumptions (e.g., 100% bioavailability and SEVs based on drinking water study were used), antimony or arsenic is not expected to have any significant impacts on ecological receptors at the site and was not identified as a COC.

Cadmium

For cadmium, the HQs for the short-tailed shrew and deer mouse exposed to surface and total soil are at one and the HQs for all the other receptors are below one. The alternative HQs based on the maximum detected concentration and the LOAEL SEV are 0.1 (as shown in **Table J-15A**). The alternative HQs based on the NOAEL SEV and the mean concentration of cadmium in surface and total soil for the shrew are 0.2 (as shown in **Table J-17A**). The alternative HQs based on the LOAEL SEV and the mean concentration of cadmium in surface and total soil for the shrew are 0.02 (as shown in **Table J-18A**). Due to the fact that the HQs based on the SLERA are at one for the shrew and all the alternative HQs are below one and the fact that SLERA results are based on conservative assumptions (e.g., 100% bioavailability), cadmium is not expected to have any significant impacts on ecological receptors at the site and was not identified as a COC.

Cobalt

For cobalt, the HQs for the deer mouse exposed to surface and total soil are at one and the HQs for the short-tailed shrew are slightly above one at 2. The HQs for all the other receptors are below one. The NOAEL SEV was derived from the LOAEL value by adjusting the NOAEL/LOAEL multiplier. As discussed in **Section 7.6.1**, the NOAEL/LOAEL multiplier is likely to overstate potential risks. Further, the alternative HQs based on the maximum detected concentration and the LOAEL SEVs are 0.1 and 0.2 for the deer mouse and shrew, respectively (as shown in **Table J-15A**). The alternative HQs based on the NOAEL SEVs and the mean concentration of cobalt in surface and total soil for the shrew are 0.2 and 0.4 for the deer mouse and shrew, respectively (as shown in **Table J-17A**). The alternative HQs based on the LOAEL SEVs and the mean concentration of cobalt in surface and total soil are 0.02 and 0.04 for the deer mouse and shrew, respectively (as shown in **Table J-18A**). Due to

the fact that the HQs based on the SLERA are at one or slightly above one for the deer mouse and shrew and all the alternative HQs are below one and the fact that SLERA results are based on conservative assumptions (e.g., conservative SEV), cobalt is not expected to have any significant impacts on ecological receptors at the site and was not identified as a COC.

Lead

For lead, the HQs for the American robin exposed to surface and total soil are at one and the HQs for all the other receptors are below one. The HQs were based on the maximum detected concentration, the NOAEL SEV, and the site foraging frequency factor of one. A foraging frequency factor of 0.5 was used to derive alternative HQs. The alternative HQs based on the maximum detected concentration and the LOAEL SEV are 0.1 for the American robin (as shown in **Table J-15A**). The alternative HQs based on the NOAEL SEV and the mean concentration of lead in surface and total soil are 0.1 for the American robin (as shown in **Table J-17A**). The alternative HQs based on the LOAEL SEV and the mean concentration of lead in surface and total soil are 0.01 for the American robin (as shown in **Table J-18A**). Due to the fact that the HQs based on the SLERA are at one for the American robin and all the alternative HQs are below one and the fact that SLERA results are based on conservative assumptions (e.g., 100% bioavailability), lead is not expected to have any significant impacts on ecological receptors at the site and was not identified as a COC.

Silver

For silver, the HQs for the short-tailed shrew exposed to surface and total soil are at one and the HQs for all the other receptors are below one. The HQs were based on the maximum detected concentration and the NOAEL SEV. The alternative HQs based on the maximum detected concentration and the LOAEL SEV are 0.1 for the short-tailed shrew (as shown in **Table J-15A**). The alternative HQs based on the NOAEL SEV and the mean concentration of silver in surface and total soil are 0.3 and 0.2 for the shrew (as shown in **Table J-17A**). The alternative HQs based on the LOAEL SEV and the mean concentration of silver in surface and total soil are 0.03 and 0.02 for the shrew (as shown in **Table J-18A**). Due to the fact that the HQs based on the SLERA are at one for the short-tailed shrew and all the alternative HQs are below one and the fact that SLERA results are based on conservative assumptions (e.g., 100% bioavailability), silver is not expected to have any significant impacts on ecological receptors at the site and was not identified as a COC.

Thallium

For thallium, the HQs for the short-tailed shrew exposed to surface and total soil are slightly above one at 2 and the HQs for all the other receptors are below one. The HQs for the shrew were based on the maximum detected concentration and the NOAEL SEV derived from the LOAEL value. It should be noted that the NOAEL SEV identified for the SLERA (0.2 mg/kg-day) may overstate potential risks associated with thallium exposure. As an example, the toxicity reference values adopted by Navy/USEPA Region 9 BTAG and recommended by the California Department of Toxic Substances Control HERD range from 0.48 mg/kg-day to 1.43 mg/kg-day for mammals. Further, the alternative

HQs based on the maximum detected concentration and the LOAEL SEV are 0.2 (as shown in **H-15A**). The alternative HQs based on the NOAEL SEV and the mean concentration of thallium in surface and total soil for the shrew are 0.2 (as shown in **Table J-17A**). The alternative HQs based on the LOAEL SEV and the mean concentration of thallium in surface and total soil for the shrew are 0.02 (as shown in **Table J-18A**). Due to the fact that the HQs based on the SLERA are slightly above one and all the alternative HQs are below one and the fact that SLERA results are based on conservative assumptions (e.g., conservative SEV), thallium is not expected to have any significant impacts on ecological receptors at the site and was not identified as a COC.

Vanadium

For vanadium, the HQs for the deer mouse and short-tailed shrew exposed to surface and total soil are above one (9 and 15 for the deer mouse and shrew, respectively) and the HQs for all the other receptors are below one. The NOAEL SEVs were derived from the LOAEL value by adjusting the NOAEL/LOAEL multiplier. As discussed in **Section 7.6.1**, the NOAEL/LOAEL multiplier is likely to overstate potential risks. In addition, the assumption of 100% bioavailability used in the risk assessment might result in overestimate of potential risks. For vanadium, bioavailability is very low, usually found to be less than 1% of an administered dose (<http://www.tjclarkinc.com/minerals/vanadium.htm>). Further, the alternative HQs based on the maximum detected concentration and the LOAEL SEVs are 0.9 and 1 for the deer mouse and shrew, respectively (as shown in **Table J-15A**). The alternative HQs based on the LOAEL SEVs and the mean concentration of vanadium in surface and total soil are 0.6 and 1 for the deer mouse and shrew, respectively (as shown in **Table J-18A**). Due to the fact that the alternative HQs based on the LOAEL SEVs are below or at one and the fact that SLERA results are based on conservative assumptions (e.g., conservative SEV and 100% bioavailability), vanadium is not expected to have any significant impacts on ecological receptors at the site and was not identified as a COC.

Based upon the above discussions and the factors presented in **Section 7.6.1**, no COCs were identified for SEAD-59 soil.

7.6.2.2 SEAD-59 Stockpile Soil

Based on the risk estimates for the screening level ERA, one PAH (pyrene), and five metals (antimony, arsenic, lead, silver, and vanadium) in SEAD-59 Stockpile soil were identified as preliminary COCs as the associated HQs were at least one for one or more receptors (see **Table J-14B**). This section presents further evaluation of the preliminary COCs identified in SEAD-59 Stockpile soil based on the SLERA results. Upon the refinement described in this section, no COC was identified as soil COC for SEAD-59 Stockpile soil.

Pyrene

For pyrene, the HQ for the short-tailed shrew exposed to SEAD-59 Stockpile soil is at one and the HQs for all the other receptors are below one. The HQ for the shrew was based on the maximum

detected concentration and the NOAEL SEV derived from the LOAEL value for benzo(a)pyrene. The alternative HQ based on the maximum detected concentration and the LOAEL value for benzo(a)pyrene is 0.1 (as shown in **Table J-15B**). The alternative HQ based on the NOAEL SEV and the mean concentration of pyrene for the shrew is 0.4 (as shown in **Table J-17B**). The alternative HQ based on the LOAEL SEV and the mean concentration of pyrene for the shrew is 0.04 (as shown in **Table J-17B**). Due to the fact that the HQs based on the SLERA are at one for the shrew and all the alternative HQs are below one and the fact that SLERA results are based on conservative assumptions (e.g., SEV for benzo(a)pyrene was used for pyrene), pyrene is not expected to have any significant impacts on ecological receptors at the site and was not identified as a COC.

4,4'-DDT

For 4,4'-DDT, the HQ for the American robin exposed to SEAD-59 Stockpile soil is above one at 99 and the HQs for the other receptors are below one. The HQs were based on the maximum detected concentration, the NOAEL SEV, and the site foraging frequency factor of one. A foraging frequency factor of 0.5 was used to derive the alternative HQs. It should be noted that the NOAEL SEVs identified for the SLERA may overstate potential risks associated with 4,4'-DDT exposure. As an example, the toxicity reference values adopted by Navy/USEPA Region 9 BTAG and recommended by the California Department of Toxic Substances Control HERD range from 0.009 mg/kg-day to 1.5 mg/kg-day for birds. The NOAEL SEV identified for this SLERA was 0.0028 mg/kg-day for birds. Therefore, the NOAEL SEV identified for 4,4'-DDT is a conservative estimate and may overstate potential risks. The alternative HQ based on the mean lead concentration and the LOAEL SEV is below one at 0.6 for the American robin (as shown in **Table J-17B**). Due to the fact that the alternative HQ based on the LOAEL SEV and the mean concentration of 4,4'-DDT is below one for all receptors and the fact that SLERA results are based on conservative assumptions (e.g., conservative SEV, 100% bioavailability), 4,4'-DDT is not expected to have any significant impacts on ecological receptors at the site and was not identified as a COC.

Antimony and Arsenic

For antimony and arsenic, the HQs for all mammalian receptors exposed to SEAD-59 Stockpile soil are above one except that the HQ for the red fox exposed to arsenic is below one at 0.2. The HQ for the American robin exposed to arsenic is below one at 0.09. Antimony SEV was not identified for birds and therefore, risk to the American robin was not quantified for exposure to antimony. The HQs were based on the maximum detected concentration and the NOAEL SEVs. For mammals, the antimony SEVs were based on the LOAEL value from a drinking water study, and the arsenic SEVs were based on a drinking water (plus incidental food intake) study. Metals tend to be more bioavailable in their soluble forms while less bioavailable in soil. Antimony has been shown to adsorb strongly to most soils with a median percent adsorption of 93% and as much as 100% adsorption in several soil types (ATSDR, 1992). Numerous studies of the oral bioavailability of soil-bound arsenic have been conducted (reviewed in Valberg *et al.*, 1997; Ruby *et al.*, 1999). The mean bioavailability of arsenic in soil ranged from 0.03 to 0.48. Therefore, bioavailability of antimony and arsenic is expected to be much lower than that of the toxicity studies from which the SEVs were

identified. Further, the alternative HQs based on the LOAEL SEVs and the mean concentration of antimony and arsenic in SEAD-59 Stockpile soil for all mammalian receptors are below one as shown in **Table J-17B**. Due to the fact that the alternative HQs based on the LOAEL SEVs and the mean concentrations of antimony and arsenic are below one and the fact that SLERA results are based on conservative assumptions (e.g., 100% bioavailability and SEVs based on drinking water study were used), antimony or arsenic is not expected to have any significant impacts on ecological receptors at the site and was not identified as a COC.

Lead

For lead, the HQ for the red fox exposed to SEAD-59 Stockpile soil is below one at 0.4. The HQs for the other receptors are above one at 2, 5, and 4 for the deer mouse, American robin, and short-tailed shrew, respectively. The NOAEL SEVs identified for mammals were based on a study of lead acetate. Lead acetate is much more soluble than the other lead compounds expected in soil (e.g., lead carbonates and lead oxides). Therefore, the bioavailability of lead in soil is expected to be much lower than the bioavailability of lead acetate. The oral bioavailability of lead in soil has been more extensively studied than any other metal. EPA assumes a relative bioavailability factor for lead of 0.6 in its adult lead model (USEPA, 1996a). Further, the alternative HQs based on the mean lead concentration and the LOAEL SEV are below one for all receptors (as shown in **Table J-17B**). Due to the fact that the HQs based on the SLERA are slightly above one for the deer mouse, American robin, and shrew and the alternative HQs based on the mean concentration and the LOAEL SEVs are below one and the fact that SLERA results are based on conservative assumptions (e.g., 100% bioavailability), lead is not expected to have any significant impacts on ecological receptors at the site and was not identified as a COC.

Silver

For silver, the HQ for the deer mouse exposed to SEAD-59 Stockpile soil is at one and the HQ for the short-tailed shrew is slightly above one at 2. The HQs for all the other receptors are below one. The alternative HQs based on the maximum detected concentration and the LOAEL SEVs are 0.1 and 0.06 for the deer mouse and shrew, respectively (as shown in **Table J-15B**). The alternative HQs based on the NOAEL SEVs and the mean concentration of silver in SEAD-59 Stockpile soil are 0.1 and 0.05 for the deer mouse and shrew, respectively (as shown in **Table J-17B**). The alternative HQs based on the LOAEL SEVs and the mean concentration of silver in SEAD-59 Stockpile soil are 0.01 and 0.005 for the deer mouse and shrew, respectively (as shown in **Table J-17B**). Due to the fact that the HQs based on the SLERA are at one or slightly above one for the deer mouse and shrew and all the alternative HQs are below one and the fact that SLERA results are based on conservative assumptions (e.g., 100% bioavailability), silver is not expected to have any significant impacts on ecological receptors at the site and was not identified as a COC.

Vanadium

For vanadium, the HQs for the deer mouse and short-tailed shrew exposed to SEAD-59 Stockpile soil are above one (10 and 20 for the deer mouse and shrew, respectively) and the HQs for all the other receptors are below one. The NOAEL SEV was derived from the LOAEL value by adjusting the NOAEL/LOAEL multiplier. As discussed in **Section 7.6.1**, the NOAEL/LOAEL multiplier is likely to overstate potential risks. In addition, the assumption of 100% bioavailability used in the risk assessment might result in overestimate of potential risks. For vanadium, bioavailability is very low, usually found to be less than 1% of an administered dose (<http://www.tjclarkinc.com/minerals/vanadium.htm>). Further, the alternative HQs based on the maximum detected concentration and the LOAEL SEVs are 1 and 2 for the deer mouse and shrew, respectively (as shown in **Table J-15B**). The alternative HQs based on the LOAEL SEVs and the mean concentration of vanadium in SEAD-59 Stockpile soil are 0.6 and 1 for the deer mouse and shrew, respectively (as shown in **Table J-18A**). Due to the fact that the alternative HQs based on the LOAEL SEVs and the mean concentration are below or at one and the fact that SLERA results are based on conservative assumptions (e.g., conservative SEV and 100% bioavailability), vanadium is not expected to have any significant impacts on ecological receptors at the site and was not identified as a COC.

Based upon the above discussions and the factors presented in **Section 7.6.1**, no COCs were identified for SEAD-59 Stockpile soil.

7.6.2.3 SEAD-71

Based on the risk estimates for the screening level ERA, six PAHs (benzo(a)anthracene, benzo(a)pyrene, benzo(b)fluoranthene, chrysene, phenanthrene, and pyrene), one pesticide (4,4'-DDT), and several metals (antimony, arsenic, lead, thallium, vanadium, and zinc) in SEAD-71 soil (outside the Fenced Area) were identified as preliminary COCs as the associated HQs were at least one for one or more receptors (see **Table J-14C**). This section presents further evaluation of the preliminary COCs identified in SEAD-71 soil based on the SLERA results. Upon the refinement described in this section, no COC was identified as soil COCs for SEAD-71 soil.

PAHs

For benzo(a)anthracene, benzo(a)pyrene, benzo(b)fluoranthene, and chrysene, the HQs for the short-tailed shrew exposed to surface and total soil are at one and the HQs for all the other receptors are below one. For phenanthrene and pyrene, the HQs for the shrew are slightly above one at 2 and 3 for the deer mouse and shrew, respectively and the HQs for all the other receptors are below one. These HQs were based on the maximum detected concentrations and the NOAEL SEV derived from the LOAEL value for benzo(a)pyrene, the most toxic PAH. The NOAEL was developed by applying a NOAEL/LOAEL multiplier of 0.1 to the LOAEL. The conservative estimate of the NOAEL/LOAEL multiplier may result in overestimate of potential risks. In addition, Magee et al. (1996) recommended a PAH bioavailability value of 0.29 for the soil oral exposure route based on a review

of available studies. Further, the alternative HQs based on the maximum detected concentrations and the LOAEL value for benzo(a)pyrene are 0.1 for the short-tailed shrew exposed to benzo(a)anthracene, benzo(a)pyrene, benzo(b)fluoranthene, and chrysene, 0.2 for the deer mouse exposed to phenanthrene or pyrene, and 0.3 for deer mouse exposed to phenanthrene or pyrene (as shown in **Table J-15C**). The alternative HQs based on the mean concentrations in surface and total soil for all receptors are below one (as shown in **Tables J-17C and J-18C**). Due to the fact that the HQs based on the SLERA are at one or slightly above one for the deer mouse and shrew and all the alternative HQs are below one and the fact that SLERA results are based on conservative assumptions (e.g., SEV for benzo(a)pyrene was used for other PAHs, 100% bioavailability), PAHs were not expected to have any significant impacts on ecological receptors at the site and were not identified as COCs.

4,4'-DDT

For 4,4'-DDT, the HQs for the American robin are above one at 10 and the HQs are below one for all the other receptors. The HQs were based on the maximum detected concentration and the NOAEL SEVs. The NOAEL SEV for the American robin was based on the LOAEL value for brown pelican. It should be noted that the NOAEL SEVs identified for the SLERA may overstate potential risks associated with 4,4'-DDT exposure. As an example, the toxicity reference values adopted by Navy/USEPA Region 9 BTAG and recommended by the California Department of Toxic Substances Control HERD range from 0.009 mg/kg-day to 1.5 mg/kg-day for birds. The NOAEL SEV identified for this SLERA was 0.0028 mg/kg-day. Therefore, the NOAEL SEV identified for 4,4'-DDT is a conservative estimate for birds and may overstate potential risks. The alternative HQs based on the maximum detected concentration and the LOAEL SEV are at one for the American robin (as shown in **Table J-15C**). The alternative HQs based on the NOAEL SEV and the mean concentration of 4,4'-DDT in surface and total soil are slightly above one at 2 for the American robin (as shown in **Table J-17C**). The alternative HQs based on the LOAEL SEV and the mean concentration of 4,4'-DDT for the American robin are 0.2 for exposure to surface and total soil (as shown in **Table J-18C**). Due to the fact that the alternative HQs based on the LOAEL SEV and the mean concentration of 4,4'-DDT are below one for all receptors and the fact that SLERA results are based on conservative assumptions (e.g., conservative SEVs), 4,4'-DDT is not expected to have any significant impacts on ecological receptors at the site and was not identified as a COC.

Antimony and Arsenic

For antimony and arsenic, the HQs for the deer mouse and short-tailed shrew exposed to surface and total soil are above one and the HQs for all the other receptors are below one. No SEV for Antimony was identified for birds and therefore, risks to the American robin was not quantified for exposure to antimony. The HQs were based on the maximum detected concentration and the NOAEL SEVs. The SEVs for antimony were based on the LOAEL value from a drinking water study, and the SEVs for arsenic were based on a drinking water (plus incidental food intake) study. Metals tend to be more bioavailable in their soluble forms while less bioavailable in soil. Antimony has been shown to adsorb strongly to most soils with a median percent adsorption of 93% and as much as 100%

adsorption in several soil types (ATSDR, 1992). Numerous studies of the oral bioavailability of soil-bound arsenic have been conducted (reviewed in Valberg *et al.*, 1997; Ruby *et al.*, 1999). The mean bioavailability of arsenic in soil ranged from 0.03 to 0.48. Therefore, bioavailability of antimony and arsenic is expected to be much lower than that of the toxicity studies from which the SEVs were identified. Further, the alternative HQs based on the LOAEL SEVs of antimony and arsenic in surface and total soil for the deer mouse and shrew are below one as shown in **Tables J-15C and J-18C**. Due to the fact that the alternative HQs based on the LOAEL SEVs are below one and the fact that SLERA results are based on conservative assumptions (e.g., 100% bioavailability and SEVs based on drinking water study were used), antimony or arsenic is not expected to have any significant impacts on ecological receptors at the site and was not identified as a COC.

Lead

For lead, the HQs for the red fox exposed to SEAD-71 surface and total soil are below one at 0.3. The HQs for the other receptors are above one at 2, 4, and 3 for the deer mouse, American robin, and short-tailed shrew, respectively. The NOAEL SEVs identified for mammals were based on a study of lead acetate. Lead acetate is much more soluble than the other lead compounds expected in soil (e.g., lead carbonates and lead oxides). Therefore, the bioavailability of lead in soil is expected to be much lower than the bioavailability of lead acetate. The oral bioavailability of lead in soil has been more extensively studied than any other metal. EPA assumes a relative bioavailability factor of 0.6 for lead in its adult lead model (USEPA, 1996a). Further, the alternative HQs based on the maximum lead concentrations and the LOAEL SEVs are 0.2, 0.4, and 0.3 for the deer mouse, American robin, and shrew, respectively (as shown in **Table J-15C**). The alternative HQs based on the mean lead concentrations are below one for all receptors (as shown in **Tables J-17C and J-18C**). Due to the fact that the HQs based on the SLERA are slightly above one for the deer mouse, American robin, and shrew and all alternative HQs are below one and the fact that SLERA results are based on conservative assumptions (e.g., 100% bioavailability), lead is not expected to have any significant impacts on ecological receptors at the site and was not identified as a COC.

Thallium

For thallium, the HQs for the short-tailed shrew exposed to surface and total soil are slightly above one at 2, the HQs for the deer mouse exposed to surface and total soil are at one, and the HQs for all the other receptors are below one. The HQs for the deer mouse and shrew were based on the maximum detected concentration and the NOAEL SEV derived from the LOAEL value. It should be noted that the NOAEL SEV identified for the SLERA (0.2 mg/kg-day) may overstate potential risks associated with thallium exposure. As an example, the toxicity reference values adopted by Navy/USEPA Region 9 BTAG and recommended by the California Department of Toxic Substances Control HERD range from 0.48 mg/kg-day to 1.43 mg/kg-day for mammals. Further, the alternative HQs based on the maximum detected concentration and the LOAEL SEV are 0.1 and 0.2 for the deer mouse and shrew, respectively (as shown in **Table J-15C**). The alternative HQs based on the NOAEL SEV and the mean concentration of thallium in surface and total soil for the deer mouse and shrew are 0.2 and 0.3, respectively (as shown in **Table J-17C**). The alternative HQs based on the

LOAEL SEV and the mean concentration of thallium in surface and total soil for the deer mouse and shrew are 0.02 and 0.03, respectively (as shown in **Table J-18C**). Due to the fact that the HQs based on the SLERA are slightly above one and all the alternative HQs are below one and the fact that SLERA results are based on conservative assumptions (e.g., conservative SEV), thallium is not expected to have any significant impacts on ecological receptors at the site and was not identified as a COC.

Vanadium

For vanadium, the HQs for the deer mouse and short-tailed shrew exposed to surface and total soil are above one (8 and 10 for the deer mouse and shrew, respectively) and the HQs for all the other receptors are below one. The NOAEL SEVs were derived from the LOAEL value by adjusting the NOAEL/LOAEL multiplier. As discussed in **Section 7.6.1**, the NOAEL/LOAEL multiplier is likely to overstate potential risks. In addition, the assumption of 100% bioavailability used in the risk assessment might result in overestimate of potential risks. For vanadium, bioavailability is very low, usually found to be less than 1% of an administered dose (<http://www.tjclarkinc.com/minerals/vanadium.htm>). Further, the alternative HQs based on the maximum detected concentration and the LOAEL SEVs are 0.8 and 1 for the deer mouse and shrew, respectively (as shown in **Table J-15C**). The alternative HQs based on the LOAEL SEVs and the mean concentration of vanadium in surface and total soil are 0.6 and 1 for the deer mouse and shrew, respectively (as shown in **Table J-18C**). Due to the fact that the alternative HQs based on the LOAEL SEVs are below or at one and the fact that SLERA results are based on conservative assumptions (e.g., conservative SEV and 100% bioavailability), vanadium is not expected to have any significant impacts on ecological receptors at the site and was not identified as a COC.

Zinc

For zinc, the HQs for the red fox exposed to SEAD-71 surface and total soil are below one at 0.2. The HQs for the other receptors are above one at 2, 2, and 3 for the deer mouse, American robin, and short-tailed shrew, respectively. Zinc is an essential nutrient and is relatively nontoxic to most animals because they can physiologically regulate zinc absorption and excretion. Zinc is capable of forming complexes with a variety of organic and inorganic complexing groups. Sorption is the dominant reaction of zinc (ATSDR, 2003). Further, the alternative HQs based on the maximum lead concentrations and the LOAEL SEVs are 0.9, 2, and 1 for the deer mouse, American robin, and shrew, respectively (as shown in **Table J-15C**). The alternative HQs based on the mean lead concentrations are below one for all receptors (as shown in **Tables J-17C** and **J-18C**). Lead is not expected to have any significant impacts on ecological receptors at the site and was not identified as a COC based on the following facts: 1) the HQs based on the SLERA are slightly above one for the deer mouse, American robin, and shrew; 2) the alternative HQs based on the mean concentration and the NOAEL SEV are below one; 3) SLERA results are based on conservative assumptions (e.g., 100% bioavailability); and 4) zinc is an essential nutrient and organisms can physiologically regulate absorption and excretion.

Based upon the above discussions and the factors presented in **Section 7.6.1**, no COCs were identified for SEAD-71 soil.

7.7 RISK MANAGEMENT

This risk management section presents the Army's position on whether further evaluation of ecological risks is warranted based on the evaluation presented above as well as other factors, such as future use of the sites and site background. Impact to habitat based on the future use of the sites is presented in **Section 7.7.1**. A comparison of the site concentrations to background was conducted for the preliminary inorganic COCs as the rationale supporting the Army's proposal that no additional assessment is needed for the preliminary COCs identified in Step 2B. Comparison of the site data to background is presented in **Section 7.7.2**.

7.7.1 Impact to Habitat Based on Future Site Use

SEAD-59 and SEAD-71 are located in the Planned Industrial Development (PID) parcel. That is, the planned future land use for SEAD-59 and SEAD-71 is industrial development. Based on the future use of the sites, the sites are not expected to support, sustain, or attract ecological receptors and therefore are not expected to be a wildlife habitat. The presence of ecological receptors is expected to be generally curtailed in these areas where habitat conditions are poor and human activity levels are sufficiently disruptive to discourage wildlife use. Therefore, it is the Army's position that no further action is warranted at SEAD-59/71 to mitigate potential risks to ecological receptors.

7.7.2 Comparison of Site Data with Background

A streamline evaluation was conducted to compare the concentrations of the preliminary inorganic COCs identified in Step 2B in SEAD-59 soil, SEAD-59 Stockpile soil, and SEAD-71 soil to the corresponding SEDA background levels. A discussion of the SEDA background data is provided in **Section 6.3.2**. **Tables J-19 A, J-19B, and J-19C** summarize the comparison of the descriptive statistics between the site data and SEDA background for SEAD-59 soil, SEAD-59 Stockpile soil, and SEAD-71 soil, respectively.

For SEAD-59, as shown in **Table J-19A**, the site arithmetic mean concentration of each preliminary inorganic COC is below the corresponding 95% upper confidence limit of the arithmetic mean of the SEDA background except that the arithmetic mean concentrations of antimony and lead in surface soil (0-2 ft bgs.) are slightly above the 95% UCLs of background (3.6 mg/kg vs. 3.3 mg/kg for antimony and 28.4 mg/kg vs. 27.6 mg/kg for lead) and that the mean silver concentration is above the 95% UCL of background (0.70~0.73 mg/kg vs. 0.45 mg/kg).

For SEAD-59 Stockpile soil, as shown in **Table J-19B**, the site arithmetic mean concentration of each preliminary inorganic COC is below the corresponding 95% UCL of the arithmetic mean of the SEDA background except that the arithmetic mean concentration of lead in stockpile soil is above the 95% UCL of background (79 mg/kg vs. 27.6 mg/kg).

For SEAD-71, as shown in **Table J-19C**, the site arithmetic mean concentrations of antimony and vanadium are below the corresponding 95% UCL of the arithmetic means of the SEDA background. The site arithmetic mean concentrations of arsenic and thallium are close to the corresponding 95% UCL of the arithmetic means of the SEDA background (5.9 mg/kg vs. 5.97 mg/kg for arsenic and 0.35-0.37 mg/kg vs. 0.32 mg/kg). The arithmetic mean concentrations of lead and zinc in SEAD-71 soil are above the 95% UCLs of background (111-115 mg/kg vs. 27.6 mg/kg for lead and 122-125 mg/kg vs. 77.5 mg/kg).

In summary, with several exceptions (lead in SEAD-59 Stockpile soil and lead and zinc in SEAD-71), the concentrations of the preliminary inorganic COCs identified in Step 2B are consistent with SEDA background. As discussed in **Section 7.6**, these preliminary COCs are not expected to pose significant impact to the ecological receptors at the sites.

7.8 SUMMARY

In accordance with the USEPA guidance (USEPA, 1997c), a screening level ERA was performed to evaluate contaminants in SEAD-59 soil, SEAD-59 Stockpile soil, and SEAD-71 soil. This SLERA was completed in several steps.

For Steps 1 and 2, NOAEL toxicity values and conservative exposure assumptions were used to calculate screening level HQs. Due to the conservative nature of these assumptions, additional evaluation (part of Step 3) was required to more fully characterize potential ecological risks and determine if further evaluation is warranted.

The maximum detected concentrations were compared to screening criteria to identify COPCs (Step 1). Potential exposures and effects resulting from the maximum detected concentrations of soil COPCs were then evaluated by estimating potential direct and indirect exposures for terrestrial wildlife (deer mouse, American robin, short-tailed shrew, and red fox) and comparing exposures to NOAEL toxicity values (Step 2).

Some of the additional information used to help characterize risks (part of Step 3) included using alternative HQ values based on mean concentrations and LOAEL-based SEVs and analysis of factors that may result in potential overestimation of risks.

Upon completion of ERA Steps 1 and 2, there is a SMDP with four possible decisions:

- There is adequate information to conclude that ecological risks are negligible and therefore no need for remediation on the basis of ecological risks;
- The information is not adequate to make a decision at this point and the ERA process should continue to a baseline ERA;
- The information indicates a potential for adverse ecological effects, and a more thorough assessment is warranted; or

- It may be preferable to cleanup the site to the screening values for some sites of relatively small size or where the contamination has a sharply defined boundary rather than to spend time and resources determining a less conservative cleanup number.

Based on the results of the further refinement of COCs (part of Step 3), no COCs were identified for SEAD-59 soil, SEAD-59 Stockpile soil, or SEAD-71 soil for ecological receptors. In addition, the planned future land use for SEAD-59 and SEAD-71 is industrial development. Therefore, the sites are not expected to support, sustain, or attract ecological receptors and therefore are not expected to be a wildlife habitat. The presence of ecological receptors is expected to be generally curtailed in these areas where habitat conditions are poor and human activity levels are sufficiently disruptive to discourage wildlife use. Further, the concentrations of the preliminary inorganic COCs identified in Step 2B are generally consistent with SEDA background with the exception of lead in SEAD-59 Stockpile soil and lead and zinc in SEAD-71 soil. Lead or zinc is not considered as a COC for either SEAD-59 Stockpile or SEAD-71 as a result of the COC refinement. Based on the above discussion, it is the Army's position that soil at SEAD-59/71 and in SEAD-59 Stockpiles is not expected to significantly impact ecological receptors at the site and no further action is warranted at SEAD-59/71 based on the ecological risk assessment.

8.0 CONCLUSIONS AND RECOMMENDATIONS

This section provides conclusions and recommendations for the Phase II Remedial Investigation Report for the Fill Area West of Building 135 (SEAD-59) and the Alleged Paint Disposal Area (SEAD-71) at the Seneca Army Depot Activity in Romulus, New York.

8.1 CONCLUSIONS

This section summarizes the Phase II RI report conclusions for SEAD-59, SEAD-59 Stockpile soil, and SEAD-71, respectively.

8.1.1 SEAD-59

- Some analytes, primarily PAHs and metals, exist above TAGM levels in the soil. The site-wide average Benzo(a)pyrene Toxicity Equivalent concentration in surface soils (0-2 ft bgs.) and subsurface soil (2-15 ft bgs.) were 1.36 mg/kg and 1.44 mg/kg, respectively.
- Some analytes, primarily metals, exist above NYSDEC GA Standards in groundwater.
- Human health risks are within the USEPA acceptable ranges for receptors evaluated.
- Although preliminary COCs were identified based on the ecological screening risk assessment, the alternative risks (risks calculated based on LOAEL SEV toxicity values and/or mean concentrations) calculated for the site are within acceptable limits for all the preliminary COCs. SEAD-59 is located in the PID parcel and the site is not expected to support, sustain, or attract ecological receptors and therefore is not expected to be a wildlife habitat. It is the Army's position that no further action is warranted at SEAD-59 to mitigate potential risks to ecological receptors.

8.1.2 SEAD-59 Stockpile

- Some SVOC and metals were detected above TAGMs. However, the stockpiles do not pose any potential risks to human health under the industrial use scenario;
- The average BTE concentration for cPAHs was 8.1 mg/kg, which is below the NYSDEC screening value of 10 mg/kg;
- Although SEAD-59/71 is planned for future industrial development, risks for potential residents via exposure to stockpile soil were evaluated for screening purposes. Noncancer risk was slightly above the EPA limit (2 vs. 1) for a residential child; the elevated risk was caused by intake of groundwater at SEAD-59. If groundwater use restriction were in place, the noncancer risk for the child resident with exposure to SEAD-59 Stockpiles would be below the USEPA limit. Total cancer risk for a residential receptor is slightly above the EPA

limit (2E-4 vs. 1E-4) under the reasonable maximum exposure scenario. When more realistic central tendency assumptions are used, the total cancer risk is below the EPA limit (8E-5 vs. 1E-4). In summary, under a more realistic CT assumption, the stockpiles at SEAD-59 do not pose unacceptable risk to residential receptors.

- Although preliminary COCs were identified based on the ecological screening risk assessment, the alternative risks calculated for the site are within acceptable limits for all the preliminary COCs. The stockpile soils would be used within PID parcel and the site is not expected to support, sustain, or attract ecological receptors and therefore is not expected to be a wildlife habitat. It is the Army's position that no further action is warranted for the SEAD-59 stockpile soils to mitigate potential risks to ecological receptors.

Based on the above facts, it is the Army's position that the stockpiles can be used as fill or grading material.

8.1.3 SEAD-71

- Some analytes exist above TAGM levels in the soil. cPAHs and lead are elevated within the Fenced Area at the site. The elevated PAH concentrations within the Fenced Area are not expected to be associated with any release at the site based on the following facts: 1) elevated PAH concentrations detected in surface soil within the Fenced Area are likely caused by the crushed asphalt materials in the hard fill and the oil used in the construction of the storage area; 2) the soil underneath the pavement is not impacted by PAHs; 3) the Fenced Area is not associated with any CERCLA release. The maximum concentration of lead (3,470 mg/kg) was detected in a surface soil sample from the Fenced Area; however, this elevated value appears to be isolated as subsurface soil samples did not have any exceedances and lead concentrations in all the other surface soil samples from the Fenced Area were below 600 mg/kg. The average lead concentration within the Fenced Area was 350 mg/kg, which was lower than the USEPA (1998) recommended 400 mg/kg screening level for lead in soil at residential properties.
- The site-wide average BTE concentration in surface and subsurface soils were 11.6 mg/kg and 5.4 mg/kg, respectively. The site-wide average BTE concentration in surface soils in the area outside the Fenced Area was 1.64 mg/kg.
- Several metals exist above NYSDEC GA Standards in groundwater.
- When considering all soils and groundwater at SEAD-71, the total cancer risk is below the USEPA upper target limit (1×10^{-4}) for the construction worker and child trespasser. The total cancer risk is above the USEPA upper target limit for the industrial worker (2×10^{-4} vs. 1×10^{-4}). PAHs in SEAD-71 soil are the primary COPCs contributing to the cancer risks associated with SEAD-71 soil exposure. PAH concentrations within the Fenced Area are relatively high compared with other areas at SEAD-71. These elevated PAH concentrations are likely

caused by the crushed asphalt materials in the hard fill and the oil used in the construction of the storage area within the Fenced Area. Therefore, the elevated PAH concentrations in surface soil within the Fenced Area at SEAD-71 are not associated with any release at the site. When considering soils outside the Fenced Area as well as groundwater at SEAD-71, cancer risks are below the USEPA upper target limit for all receptors and PAHs in soil are not identified as COCs at the site.

- The total non-cancer hazard indices for all receptors are above or at the USEPA target limit of 1, due to groundwater intake. Risks via all exposure pathways except groundwater intake are below the USEPA target limit of 1. Iron and manganese in SEAD-71 groundwater are the primary COPCs contributing to the elevated non-cancer risks at SEAD-71. The iron and manganese concentrations in SEAD-71 groundwater are generally comparable with the SEDA background. In addition, the iron and manganese concentrations detected in the downgradient monitoring well are consistent with the SEDA background and were not identified as COCs at the site.
- Although preliminary COCs were identified based on the ecological screening risk assessment, the alternative risks calculated for the site are within acceptable limits for all the preliminary COCs. Based on the results of the further refinement of COCs (part of Step 3), no COCs were identified for SEAD-71 soil for ecological receptors. SEAD-71 is located in the PID parcel and the site is not expected to support, sustain, or attract ecological receptors and therefore is not expected to be a wildlife habitat. It is the Army's position that no further action is warranted at SEAD-71 to mitigate potential risks to ecological receptors.

8.2 RECOMMENDATIONS

The baseline human health risk assessment and the screening level ecological risk assessment conducted for the sites indicate that the sites pose no significant risk to human health or the environment. Therefore the following recommendations are made for SEAD-59 and SEAD-71:

- Apply institutional controls in the form of land use restrictions on SEAD-59 and SEAD-71 as described in the Final Record of Decision for Sites Requiring Institutional Controls in the Planned Industrial/Office Development or Warehousing Areas (Parsons, 2004), signed on September 28, 2004 by USEPA:
 - Prohibit the development and use of property for residential housing, elementary and secondary schools, childcare facilities and playgrounds.
 - Prevent access to or use of groundwater until the Class GA Groundwater Standards and Guidance values are met.
- Proceed with Proposed Plan and Record of Decision for these sites.

- The stockpile soil at SEAD-59 is suitable for use as fill or grading material.

Table 1-1
SEAD-59 ESI Monitoring Well Level Summary
SEAD-59 and SEAD-71 Phase II RI Report
Seneca Army Depot Activity

Monitoring Well Number	Top of PVC Casing Elevation (MSL) ¹	Well Depth BGS ² (ft)	Well Development			Sampling			Water Level Measurements		
			Date	Depth to Groundwater TOC (ft)	Groundwater Elevation (MSL)	Date	Depth to Groundwater TOC (ft)	Groundwater Elevation (MSL)	Date	Depth to Groundwater TOC (ft)	Groundwater Elevation (MSL)
MW59-1	729.03	9.20	3/21/94	1.72	727.31	3/30/94	1.60	727.43	7/6/94	4.28	724.75
									7/26/94	4.44	724.59
MW59-2	728.95	11.40	3/8/94	3.40	725.55	7/21/94	6.55	722.40	7/6/94	5.59	723.36
									7/26/94	5.58	723.37
MW59-3	737.34	8.80	3/20/94	1.44	735.90	7/21/94	5.20	732.14	7/6/94	3.87	733.47
									7/26/94	3.91	733.43

Note:

1) Top of PVC Casing Elevation were re-measured after the 2002 TCRA

2) BGL - Below Ground Surface

Table 1-2
SEAD-71 ESI Monitoring Well Level Summary
SEAD-59 and SEAD-71 Phase II RI Report
Seneca Army Depot Activity

Monitoring Well Number	Top of PVC Casing Elevation (MSL) ¹	Well Depth BGS ² (ft)	Well Development			Sampling			Water Level Measurements		
			Date	Depth to Groundwater TOC (ft)	Groundwater Elevation (MSL)	Date	Depth to Groundwater TOC (ft)	Groundwater Elevation (MSL)	Date	Depth to Groundwater TOC (ft)	Groundwater Elevation (MSL)
MW71-1	738.36	9.40	3/16/94	4.48	733.88	3/29/94	5.15	733.21	7/6/94	6.58	731.78
									7/26/94	5.73	732.63
MW71-2	741.79	6.60	4/5/94	4.85	736.94	7/10/94	5.46	736.33	7/6/94	5.46	736.33
									7/26/94	4.94	736.85
MW71-3	738.79	6.40	4/5/94	6.43	732.36	7/7/94	5.95	732.84	7/6/94	5.88	732.91
									7/26/94	6.09	732.70

Note:

1) Top of PVC Casing Elevation were re-measured after the 2002 TCRA

2) BGS - Below Ground Surface

**Table 1-3
Climatological Data for Seneca Army Dept Activity
SEAD-59 and SEAD-71 Phase II RI Report
Seneca Army Depot Activity**

Month	Temperature (1), °F			Mean Precipitation (1), in.	Mean Relative Humidity (%)	Percent Sunshine	Mean Number of Days (4)		
	Maximum	Minimum	Mean				Clear	Partly Cloudy	Cloudy
January	30.9	14.0	22.5	1.88	70	35	3	7	21
February	32.4	14.1	23.3	2.16	70	50	3	6	19
March	40.6	23.4	32.0	2.45	70	50	4	7	20
April	54.9	34.7	44.8	2.86	70	50	6	7	17
May	66.1	42.9	54.5	3.17	70	50	6	10	15
June	76.1	53.1	64.6	3.70	70	60	8	10	12
July	80.7	57.2	69.0	3.46	70	60	8	13	10
August	78.8	55.2	67.0	3.18	70	60	8	11	12
September	72.1	49.1	60.7	2.95	70	60	7	11	12
October	61.2	39.5	50.3	2.80	70	50	7	8	16
November	47.1	31.4	39.3	3.15	70	30	2	6	22
December	35.1	20.4	27.8	2.57	70	30	2	5	24
Annual	56.3	36.3	46.3	34.33	70	50	64	101	200

Period	Mixing Height (2), m	Wind Speed (2), m/s
Morning (Winter)	900	8
Morning (Spring)	700	6
Morning (Summer)	500	5
Morning (Autumn)	600	5
Morning (Annual)	650	6
Afternoon (Winter)	900	8
Afternoon (Spring)	1600	8
Afternoon (Summer)	1800	7
Afternoon (Autumn)	1300	7
Afternoon (Annual)	1400	7

Mean Annual Pan Evaporation (3), inches : 35
Mean Annual Lake Evaporation (3), inches : 28

Number of episodes lasting more than 2 days (2), (No. of episode-days) :
 Mixing Height < 500 m, wind speed < 2 m/s : 0 (0)
 Mixing Height < 1000 m, wind speed < 2 m/s : 0 (0)
Number of episodes lasting more than 5 days (2), (No. of episode-days) :
 Mixing Height < 500 m, wind speed < 4 m/s : 0 (0)

Notes:

- 1) Climate of New York Climatology of the United States No. 60. National Oceanic and Atmospheric Administration, June 1982. Data for Ithaca Cornell University, NY.
- 2) Mixing Heights, Wind Speeds, and Potential for Urban Air Pollution throughout the Contiguous United States. George C. Holzworth, Jan. 1972.
- 3) Climate Atlas of the United States. U.S. Department of Commerce, 1983.
- 4) Climate of New York Climatology of the United States No. 60. National Oceanic and Atmospheric Administration, June 1982. Data for Syracuse, NY.

**Table 3-1
Summary of 2002 TCRA Rejected Analytical Results
SEAD-59 AND SEAD-71 PHASE II RI REPORT
Seneca Army Depot Activity**

Sample	SDG	Sample Date	Rejected Fraction	Reason	Rejected Analytical Results
CL-59-OTHERB-WW1	A1380	9/19/2002	VOC nondetects associated with DCB	IS3 internal standard area less than 25% of the 12-hr standard area	1,1,2,2-tetrachloroethane, 1,3-dichlorobenzene, 1,4-dichlorobenzene, 1,2-dichlorobenzene, 1,2-dibromo-3-chloropropane, 1,2,4-trichlorobenzene
CL-59-01-WW1, CL-59-01-WN2, CL-59-01-WW4	A1406	9/25/2002	VOC nondetects associated with DCB	IS3 internal standard area less than 25% of the 12-hr standard area	1,1,2,2-tetrachloroethane, 1,3-dichlorobenzene, 1,4-dichlorobenzene, 1,2-dichlorobenzene, 1,2-dibromo-3-chloropropane, 1,2,4-trichlorobenzene, xylene (Total)
CL-71-E1-WW1, CL-71-E1-WS1, CL-71-B-WN1	A1418	9/26/2002	VOC nondetects associated with DCB	IS3 internal standard area less than 25% of the 12-hr standard area	1,1,2,2-tetrachloroethane, 1,3-dichlorobenzene, 1,4-dichlorobenzene, 1,2-dichlorobenzene, 1,2-dibromo-3-chloropropane, 1,2,4-trichlorobenzene, xylene (Total)
WS-59-04-010-7	A1433 ?A1423 according to ENSR table?	9/30/2002	VOC nondetects associated with DCB	IS3 internal standard area less than 25% of the 12-hr standard area	1,1,2,2-tetrachloroethane, 1,3-dichlorobenzene, 1,4-dichlorobenzene, 1,2-dichlorobenzene, 1,2-dibromo-3-chloropropane, 1,2,4-trichlorobenzene, xylene (Total)
WS-71-B-009-8 and WS-59-04-010-6	A1433 ?A1423 according to ENSR table?	9/30/2002	VOC nondetects associated with DCB	IS3 internal standard area less than 25% of the 12-hr standard area	1,1,2,2-tetrachloroethane, 1,3-dichlorobenzene, 1,4-dichlorobenzene, 1,2-dichlorobenzene, 1,2-dibromo-3-chloropropane, 1,2,4-trichlorobenzene
WS-59-04-010-3	A1434	10/1/2002	VOC nondetects associated with DCB	IS3 internal standard area less than 25% of the 12-hr standard area	1,1,2,2-tetrachloroethane, 1,3-dichlorobenzene, 1,4-dichlorobenzene, 1,2-dichlorobenzene, 1,2-dibromo-3-chloropropane, 1,2,4-trichlorobenzene, xylene (Total)
CL-59-01-F10 and CL-59-01-F03	A1469	10/8/2002	All VOC nondetects	All three internal standards had area less than 25% of the 12-hr standard areas	All VOC nondetects (not listed here)

**Table 3-1
Summary of 2002 TCRA Rejected Analytical Results
SEAD-59 AND SEAD-71 PHASE II RI REPORT
Seneca Army Depot Activity**

Sample	SDG	Sample Date	Rejected Fraction	Reason	Rejected Analytical Results
CL-59-01-WS5	A1480	10/9/2002	VOC nondetects associated with DCB	IS3 internal standard area less than 25% of the 12-hr standard area	1,1,2,2-tetrachloroethane, 1,3-dichlorobenzene, 1,4-dichlorobenzene, 1,2-dichlorobenzene, 1,2-dibromo-3-chloropropane, 1,2,4-trichlorobenzene, xylene (Total)
WS-59-01-006-9	R2213831	9/23/2002	VOC nondetects associated with DCB	DCB internal standard area less than 25% of the 12-hr standard area	1,1,2,2-tetrachloroethane, 1,2,3-trichloropropane, 1,3-dichlorobenzene, 1,4-dichlorobenzene, 1,2-dichlorobenzene, 1,2,4-trichlorobenzene

Notes:

1. All samples presented in the table were collected during the 2002 TCRA.
2. CL-59-01-WW2, CL-59-01-WN1RE, and CL-71-D-WN1RE in SDG A1406 had DCB internal standard area <25% of 12-hr standard; the results of their replicates were recommended to represent the sample results.
3. CL-59-01-F01RE in SDG A1418 had DCB internal standard area <25% of 12-hr standard, the results of CL-59-01-F01 were recommended to represent the sample results.

Table 3-2A
SEAD-59 Determination of Use of Historical Sample
SEAD-59 and SEAD-71 Phase II RI Report
Seneca Army Depot Activity

Historic Sample Location	Excavation Area ¹	Pre-Excavation Sample Elevation (ft)		Elevation of Excavation Limit ² (ft)	Retained in Dataset or Excavated
		Top	Bottom		
SEAD-59					
MW59-4	Area-2	729.5	727.5	730.4	Retained
MW59-6	Area-4	736.4	734.8	733.7	Excavated
SB59-1	Area-1B	739.5	739.3	731.5	Excavated
SB59-1	Area-1B	733.5	731.5	731.5	Retained
SB59-1	Area-1B	733.5	731.5	731.5	Retained
SB59-1	Area-1B	729.5	727.5	731.5	Retained
SB59-10	Area-Other C	734	733.2	732.0	Excavated
SB59-11	NA	-	-	-	Retained
SB59-13	NA	-	-	-	Retained
SB59-14	Area-1B	736	734.4	731.5	Excavated
SB59-15	Area-1B	733	731.7	731.5	Retained
SB59-16	Area-1B	738	736.5	731.5	Excavated
SB59-17	Area-1A	729	727.8	731.5	Retained
SB59-17	Area-1A	729	727.8	731.5	Retained
SB59-18	Area-1A	731	730	731.5	Retained
SB59-19	Area-1A	733.5	732.8	731.5	Excavated
SB59-2	Area-1B	737.5	737.3	731.5	Excavated
SB59-2	Area-1B	737.5	737.3	731.5	Excavated
SB59-2	Area-1B	735.5	733.5	731.5	Retained
SB59-2	Area-1B	731.5	730.5	731.5	Retained
SB59-20	Area-1B	737	736.6	731.5	Excavated
SB59-20	Area-1B	737	736.6	731.5	Excavated
SB59-20	Area-1B	736	734.9	731.5	Excavated
SB59-20	Area-1B	736	734.9	731.5	Excavated
SB59-20	Area-1B	734	733.5	731.5	Retained
SB59-20	Area-1B	734	733.5	731.5	Retained
SB59-21	NA	-	-	-	Retained
SB59-3	Area-1B	741	740.8	731.5	Excavated
SB59-3	Area-1B	739	737	731.5	Excavated
SB59-3	Area-1B	735	733	731.5	Retained
SB59-4	Area-1B	742	741.8	731.5	Excavated
SB59-4	Area-1B	734	732	731.5	Retained
SB59-4	Area-1B	732	722	731.5	Retained
SB59-5	Area-1A	739	738.8	731.5	Excavated
SB59-5	Area-1A	735	733	731.5	Retained
SB59-5	Area-1A	729	727	731.5	Retained
SB59-7	Area-2	733.5	731.5	730.4	Excavated
SB59-8	Area-3	733	731	730.1	Retained
SB59-9	Area-3	735	734	732.1	Excavated
SB59-9	Area-3	735	734	732.1	Excavated
SB59-9	Area-3	733	731.3	732.1	Retained
SB59-9	Area-3	731	729.9	732.1	Retained
SB59-9	Area-3	731	729.9	732.1	Retained
TP59-1	Area-3	733	733	732.1	Excavated
TP59-10-2	Area-1A	735	734.5	731.5	Excavated
TP59-11A-2	Area-1B	734.25	733.75	731.5	Retained
TP59-12A-1	Area-3	733	732.5	731.1	Excavated
TP59-12A-2	Area-3	733	732.5	731.1	Excavated
TP59-12B-2	Area-3	731.5	731	731.1	Excavated
TP59-13A-1	Area-2	729.5	729	729.9	Retained
TP59-13C-1	Area-2	730	729.5	729.9	Retained
TP59-14-3	Area-1B	736	735.5	731.5	Excavated
TP59-15-1	Area-1A	732.5	732.5	731.5	Excavated
TP59-15-5	Area-1A	732.5	732	731.5	Retained
TP59-16-1	Area-1B	734	733.5	731.5	Retained

Table 3-2A
SEAD-59 Determination of Use of Historical Sample
SEAD-59 and SEAD-71 Phase II RI Report
Seneca Army Depot Activity

Historic Sample Location	Excavation Area ¹	Pre-Excavation Sample Elevation (ft)		Elevation of Excavation Limit ² (ft)	Retained in Dataset or Excavated
		Top	Bottom		
TP59-17-3	Area-1B	734	733.5	731.5	Retained
TP59-18-1	Area-4	735.4	734.9	733.7	Excavated
TP59-2	Area-1B	729.25	729.25	731.5	Retained
TP59-3	Area-1B	737	737	731.5	Excavated
TP59-3	Area-1B	737	737	731.5	Excavated
TP59-3	Area-1B	735.5	735.5	731.5	Excavated
TP59-4	Area-1A	739.5	739.5	731.5	Excavated
TP59-5	Area-1A	730.5	730.5	731.5	Retained
TP59-6-2	NA	730	729.5	-	Retained
TP59-7-2	Area-1A	734	733.5	731.5	Excavated
TP59-8-2	NA	-	-	-	Retained
TP59-9-2	NA	-	-	-	Retained

Notes:

- 1) Excavation Area based on Figure 2-7, "SEAD-59 2002 TCRA Excavation Areas". NA means the sample was collected from outside an excavation area.
- 2) Elevation based on As-Built drawing and field notes from ENSR, 2002.

Table 3-2B
SEAD-71 Determination of Use of Historical Sample
SEAD-59 and SEAD-71 Phase II RI Report
Seneca Army Depot Activity

Historic Sample Location	Excavation Area ¹	Pre-Excavation Sample Elevation (ft)		Elevation of Excavation Limit ² (ft)	Retained in Dataset or Excavated
		Top	Bottom		
SEAD-71					
SS71-1	NA	743.5	743.3	-	Retained
SS71-10	NA	745	744.8	-	Retained
SS71-11	NA	-	-	-	Retained
SS71-12	NA	-	-	-	Retained
SS71-13	NA	-	-	-	Retained
SS71-14	NA	-	-	-	Retained
SS71-15	NA	-	-	-	Retained
SS71-16	NA	-	-	-	Retained
SS71-17	NA	-	-	-	Retained
SS71-18	NA	-	-	-	Retained
SS71-19	NA	-	-	-	Retained
SS71-2	NA	743.5	743.3	-	Retained
SS71-20	NA	-	-	-	Retained
SS71-3	Area-E2	744	743.8	742.4	Retained
SS71-4	NA	744	743.8	-	Retained
SS71-5	NA	-	-	-	Retained
SS71-6	NA	-	-	-	Retained
SS71-7	Area-C	744.5	744.3	742.0	Excavated
SS71-7	Area-C	744.5	744.3	742.0	Excavated
SS71-8	NA	744.5	744.3	-	Retained
SS71-9	NA	745	744.8	-	Retained
TP71-1	NA	741	741	-	Retained
TP71-1	NA	741	741	-	Retained
TP71-1	NA	741	741	-	Retained
TP71-1	NA	740	740	-	Retained
TP71-2	NA	-	-	-	Retained
TP71-2	NA	-	-	-	Retained
TP71-2	NA	-	-	-	Retained
TP71-2	NA	-	-	-	Retained
TP71-3-1	NA	744	736	-	Retained
TP71-3-2	NA	733.5	733	-	Retained
TP71-4-2	NA	734	733.5	-	Retained
TP71-5-1	NA	735	734.5	-	Retained
TP71-6-1	NA	731	730.5	-	Retained

Notes:

- 1) Excavation Area based on Figure 2-8, "SEAD-71 2002 TCRA Excavation Areas". NA means the sample was collected from outside an excavation area.
- 2) Elevation based on As-Built drawing and field notes from ENSR, 2002.

Table 3-3A
Soil Samples Representative of Current Site Conditions - SEAD-59
SEAD-59 AND SEAD-71 PHASE II RI REPORT
Seneca Army Depot Activity

TCRA Confirmatory Sample ²		TCRA Backfilled Windrow Sample ³		Historical Sample ⁴
CL-59-01-F01	CL-59-01-WW1	WS-59-01-004-7	WS-59-01-018-1	MW59-4 (59055)
FD-71-CL-04	CL-59-01-WW2	WS-59-01-006-11	WS-59-01-018-2	SB59-1 (SB59-1-08)
CL-59-01-F02	CL-59-01-WW3	WS-59-01-006-2	WS-59-01-018-3	SB59-1 (SB59-1-04)
CL-59-01-F03	CL-59-01-WW4	WS-59-01-006-4	WS-59-01-018-4	SB59-1 (SB59-1-06)
CL-59-01-F04	FD-59-CL-3	WS-59-01-006-5	WS-59-01-018-5	SB59-11 (59132)
CL-59-01-F05	CL-59-02-F01	WS-59-01-006-6	WS-59-01-018-6	SB59-13 (59060)
CL-59-01-F06	CL-59-02-F02	WS-59-01-006-8	WS-59-01-018-7	SB59-15 (59061)
CL-59-01-F07	FD-59-CL-02	WS-59-01-007-3	WS-59-01-018-8	SB59-17 (59131)
CL-59-01-F08	CL-59-02-WE1	WS-59-01-007-4	WS-59-02-002-1	SB59-17 (59068)
CL-59-01-F09	CL-59-02-WE2	WS-59-01-007-7	WS-59-02-002-2	SB59-18 (59127)
CL-59-01-F10	CL-59-02-WN1	WS-59-01-007-9	WS-59-02-002-3	SB59-2 (SB59-2-02)
FD-59-CL-06	CL-59-02-WN2	WS-59-01-011-3	WS-59-02-003-1	SB59-2 (SB59-2-04)
CL-59-01-F11	CL-59-02-WS1	WS-59-01-011-4	WS-59-02-003-2	SB59-20 (59107)
CL-59-01-F12	CL-59-02-WS2	WS-59-01-012-1	WS-59-02-003-3	SB59-20 (59066)
CL-59-01-F13	CL-59-02-WW1	FD-59-WS-6	WS-59-02-003-4	SB59-21 (59067)
CL-59-01-F14	CL-59-02-WW2	WS-59-01-013-1	WS-59-02-003-5	SB59-3 (SB59-3-04)
CL-59-01-F15	CL-59-03-F01	WS-59-01-013-3	WS-59-02-004-1	SB59-4 (SB59-4-05)
CL-59-01-F16	CL-59-03-F02	WS-59-01-013-4	WS-59-03-001-1	SB59-4 (SB59-4-10)
CL-59-01-F17	CL-59-03-F03	WS-59-01-013-5	WS-59-03-001-2	SB59-5 (SB59-5-03)
CL-59-01-F18	CL-59-03-WE1	WS-59-01-013-6	WS-59-03-001-3	SB59-5 (SB59-5-06)
CL-59-01-F19	CL-59-03-WN1	WS-59-01-013-7	FD-59-WS-01	SB59-8 (59057)
CL-59-01-F20	CL-59-03-WN2	WS-59-01-014-1	WS-59-03-002-1	SB59-9 (59059)
CL-59-01-F21	CL-59-03-WN3	WS-59-01-014-2	WS-59-03-002-2	SB59-9 (59089)
CL-59-01-F22	CL-59-03-WS1	WS-59-01-014-3	WS-59-03-002-3	SB59-9 (59085)
CL-59-01-F23	CL-59-03-WS2	WS-59-01-014-4	WS-59-03-002-4	TP59-11A-2 (59026)
FD-59-CL-7	CL-59-03-WS3	WS-59-01-015-1	WS-59-04-010-1	TP59-13A-1 (59010)
CL-59-01-F24	CL-59-03-WW1	WS-59-01-015-10	WS-59-04-010-10	TP59-13C-1 (59015)
CL-59-01-F25	CL-59-04-F01	WS-59-01-015-11	WS-59-04-010-11	TP59-15-5 (59035)
CL-59-01-F26	CL-59-04-F04	WS-59-01-015-13	WS-59-04-010-3	TP59-16-1 (59036)
CL-59-01-WE1	CL-59-04-WE1	FD-59-WS-07	WS-59-04-010-4	TP59-17-3 (59044)
CL-59-01-WE2	CL-59-04-WN1	WS-59-01-015-18	FD-59-WS-05	TP59-2 (TP59-2)
CL-59-01-WE3	CL-59-04-WN2	WS-59-01-015-19	WS-59-04-010-5	TP59-5 (TP59-5)
CL-59-01-WE4	CL-59-04-WS1	WS-59-01-015-2	WS-59-04-010-6	TP59-6-2 (59002)
CL-59-01-WE5	CL-59-04-WS2	WS-59-01-015-5	WS-59-04-010-7	TP59-8-2 (59050)
CL-59-01-WN1	CL-59-04-WW1	WS-59-01-015-6	WS-59-04-010-9	TP59-9-2 (59052)
CL-59-01-WN2	CL-59-OTHERA-F01	WS-59-01-015-7	WS-59-OtherC-001-1	TP59-9-2 (59053)
CL-59-01-WN3	CL-59-OTHERA-WE1	WS-59-01-015-9		
CL-59-01-WN4	CL-59-OTHERA-WN1	WS-59-01-016-11		
CL-59-01-WN5	CL-59-OTHERA-WS1	WS-59-01-016-12		
CL-59-01-WN6	CL-59-OTHERA-WW1	WS-59-01-016-15		
CL-59-01-WS1	CL-59-OTHERB-F01	FD-59-WS-8		
FD-59-CL-05	CL-59-OTHERB-WE1	WS-59-01-016-16		
CL-59-01-WS2	CL-59-OTHERB-WN1	WS-59-01-016-17		
CL-59-01-WS3	CL-59-OTHERB-WS1	WS-59-01-016-7		
CL-59-01-WS4	CL-59-OTHERB-WW1	WS-59-01-016-8		
CL-59-01-WS5	CL-59-OTHERC-F01	WS-59-01-017-1		

Table 3-3A
Soil Samples Representative of Current Site Conditions - SEAD-59
SEAD-59 AND SEAD-71 PHASE II RI REPORT
Seneca Army Depot Activity

TCRA Confirmatory Sample ²		TCRA Backfilled Windrow Sample ³		Historical Sample ⁴
CL-59-01-WS6	CL-59-OTHERC-WE2	WS-59-01-017-2		
CL-59-OTHERC-WN1				
FD-59-CL-01				
CL-59-OTHERC-WS1				
CL-59-OTHERC-WW1				

Notes:

1. All samples are considered surface samples (0-2 feet) except for those historical samples which are bold faced. Bold faced samples are subsurface samples collected from 2-15 feet below ground surface.
2. List of samples was derived based on Table 1 of the Final Draft Removal Report (ENSR, 2002). Field duplicates were not presented in Table 1 of the ENSR report but are included here based on the review of the sample chain of custody reports. CL-59-OTHERC-WE1 is presented in Table 1 of the ENSR report but is not included in this table based on the review of notations made in the ENSR report.
3. List of samples comprises all TCRA windrow samples marked as backfilled in Table 1 of the ENSR report. Field duplicates were not presented in Table 1 of the ENSR report but are included here based on the review of the sample chain of custody reports.
4. List of samples was derived based on the evaluation of all soil data collected during the Expanded Site Inspection and Phase I Remedial Investigation. Samples with associated soil considered in-place were included in this table. Sample location is listed with sample ID presented in the parenthesis.

Table 3-3B
Soil Samples Representative of Current Site Conditions - SEAD-71
SEAD-59 AND SEAD-71 PHASE II RI REPORT
Seneca Army Depot Activity

TCRA Confirmatory Sample ²		TCRA Backfilled Windrow Sample ³	Historical Sample ⁴	
CL-71-A-F01	CL-71-D-WE1	WS-71-A-009-9	SS71-1 (71013)	SS71-6 (71028) ⁴
CL-71-A-WE1	CL-71-D-WN1	WS-71-B-009-6	SS71-10 (71017)	SS71-8 (71019)
CL-71-A-WN1	CL-71-D-WS1	WS-71-B-009-8	SS71-11 (71024) ⁴	SS71-9 (71018)
CL-71-A-WS1	CL-71-D-WW3	WS-71-D-009-2	SS71-12 (71023) ⁴	TP71-1 (TP71-1-1)
CL-71-A-WW1	CL-71-E1-F01	WS-71-D-009-13	SS71-13 (71027) ⁴	TP71-1 (TP71-1-2)
CL-71-B-F01	CL-71-E1-WE1	WS-71-E1-009-3	SS71-14 (71025)	TP71-1 (TP71-1-3)
CL-71-B-WE2	CL-71-E1-WN1	WS-71-E3-009-10	SS71-15 (71032) ⁴	TP71-1 (TP71-1-4)
CL-71-B-WN1	CL-71-E1-WS1		SS71-16 (71021) ⁴	TP71-2 (TP71-2-1) ⁴
CL-71-B-WS1	CL-71-E1-WW1		SS71-17 (71030) ⁴	TP71-2 (TP71-2-2) ⁴
CL-71-B-WW1	CL-71-E2-F01		SS71-18 (71022) ⁴	TP71-2 (TP71-2-3) ⁴
CL-71-B-WW2	CL-71-E2-WE1		SS71-19 (71020) ⁴	TP71-2 (TP71-2-4) ⁴
CL-71-C-F01	CL-71-E2-WN1		SS71-2 (71014)	TP71-3-1 (71002)
CL-71-C-F02	CL-71-E2-WS1		SS71-20 (71031) ⁴	TP71-3-2 (71003)
CL-71-C-WE1	CL-71-E2-WW1		SS71-3 (71015)	TP71-4-2 (71006)
CL-71-C-WE2	CL-71-E3-F01		SS71-4 (71016)	TP71-5-1 (71007)
CL-71-C-WN1	CL-71-E3-WE1		SS71-5 (71029) ⁴	TP71-6-1 (71010)
CL-71-C-WS1	CL-71-E3-WN1			
CL-71-C-WW2	CL-71-E3-WS1			
CL-71-D-F01	CL-71-E3-WW1			

Notes:

1. All samples are considered surface samples (0-2 feet) except for those historical samples which are bold faced. Bold faced samples are subsurface samples collected from 2-15 feet below ground surface.
2. List of samples was derived based on Table 1 of the Final Draft Removal Report (ENSR, 2002). Field duplicates were not presented in Table 1 of the ENSR report but are included here based on the review of the sample chain of custody reports. The following four confirmatory samples presented in Table 1 of the ENSR report are not included in this table based on the review of notations made in the ENSR report: CL-71-B-WE1, CL-71-C-WW1, CL-71-D-WW1, and CL-71-D-WW2.
3. List of samples comprises all TCRA windrow samples marked as backfilled in Table 1 of the ENSR report. Field duplicates were not presented in Table 1 of the ENSR report but are included here based on the review of the sample chain of custody reports. Sample WS-71-E1-009-3 was designated as stockpile in Table 1 of the ENSR report; however, the 10/31/02 note presented in the report indicated the referenced windrow was backfilled. Based on this note and the fact that no excavated material was observed stockpiled at SEAD-71, soil associated with WS-71-E1-009-3 was assumed backfilled.
4. List of samples was derived based on the evaluation of all soil data collected during the Expanded Site Inspection and Phase I Remedial Investigation. Samples with associated soil considered in-place were included in this table. Sample location is listed with sample ID presented in the parenthesis.
5. These samples were collected from the Fenced Area.

Table 3-3C
Soil Samples Representative of Current Site Conditions - SEAD-59 Stockpile
SEAD-59 AND SEAD-71 PHASE II RI REPORT
Seneca Army Depot Activity

No.	TCRA Stockpile Sample ¹	Stockpile Location
1	WS-59-01-005-4	South Staging
2	WS-59-01-005-5	South Staging
3	WS-59-01-006-1	North Staging
4	WS-59-01-006-12	North Staging
5	FD-59-WS-03	North Staging
6	WS-59-01-006-3	North Staging
7	WS-59-01-006-7	North Staging
8	WS-59-01-006-9	North Staging
9	WS-59-01-007-1	North Staging
10	WS-59-01-007-10	North Staging
11	WS-59-01-007-11	North Staging
12	WS-59-01-007-12	North Staging
13	WS-59-01-007-13	North Staging
14	WS-59-01-007-14	North Staging
15	WS-59-01-007-2	North Staging
16	WS-59-01-007-5	North Staging
17	WS-59-01-007-6	North Staging
18	WS-59-01-007-8	North Staging
19	WS-59-01-008-1	Building 128
20	WS-59-01-008-2	Building 128
21	WS-59-01-008-3	Building 128
22	WS-59-01-011-1	Additional Staging
23	WS-59-01-011-2	Additional Staging
24	WS-59-01-011-5	Additional Staging
25	WS-59-01-011-6	Additional Staging
26	WS-59-01-011-7	Additional Staging
27	WS-59-01-011-8	Additional Staging
28	WS-59-01-011-9	Additional Staging
29	WS-59-01-012-2	Additional Staging
30	WS-59-01-012-3	Additional Staging
31	WS-59-01-013-2	Additional Staging ²
32	WS-59-01-014-5	Additional Staging
33	WS-59-01-015-14	South Staging
34	WS-59-01-015-15	South Staging
35	WS-59-01-015-16	South Staging
36	WS-59-01-015-17	South Staging
37	WS-59-01-015-20	South Staging
38	WS-59-01-015-3	South Staging
39	WS-59-01-015-4	South Staging
40	WS-59-01-015-8	South Staging
41	WS-59-01-016-1	South Staging
42	WS-59-01-016-10	South Staging
43	WS-59-01-016-13	South Staging
44	WS-59-01-016-14	South Staging
45	WS-59-01-016-18	South Staging
46	WS-59-01-016-19	South Staging
47	WS-59-01-016-2	South Staging
48	WS-59-01-016-20	South Staging
49	WS-59-01-016-3	South Staging
50	WS-59-01-016-4	South Staging
51	WS-59-01-016-5	South Staging
52	WS-59-01-016-6	South Staging
53	WS-59-01-016-9	South Staging
54	WS-59-04-010-8	SEAD-59 Area 4

Note:

- 1) All samples marked as stockpile in Table 1 of the ENSR report are included in the list. Field duplicates were not presented in Table 1 of the ENSR report but are included here based on the review of the sample chain of custody reports.
- 2) The location of sample WS-59-01-013-2 is based on ENSR Daily Reports from 10/2/2002 and 10/29/2002, indicating the corresponding pile to the windrow sample was placed in the Additional Staging area.

TABLE 3-4
SUMMARY OF WELL DEVELOPMENT CRITERIA
SEAD-59 and SEAD-71 Phase II RI Report
Seneca Army Depot Activity

Water Quality Indicator Parameter	Development Criteria
Water Volume Removed	At least three well volumes*
Dissolved Oxygen	± 10 %
PH	± 0.1
Specific Conductance	± 3 %
Temperature	± 10%
Turbidity	± 10 %, Preferably < 10 NTUs
* unless well pumped to dryness and low recharge.	

**TABLE 3-5
GROUNDWATER ELEVATION DATA - 2004 SAMPLING EVENTS
SEAD-59 AND SEAD-71 PHASE II RI REPORT
SENECA ARMY DEPOT ACTIVITY**

Monitoring Well	Top of Riser Elevation (ft) (5)	April 2004				August 2004			
		Saturated Thickness	Depth to Groundwater (ft)	Water Level Elevation (ft)	Total Depth (ft)	Saturated Thickness	Depth to Groundwater (ft)	Water Level Elevation (ft)	Total Depth (ft)
MW59-1(1)	729.03	7.05	1.81	727.22	8.86	6.38	2.62	726.41	9
MW59-2(2)	728.95	9.87	3.06	725.89	12.93	10.06	3.22	725.73	13.28
MW59-3(2)	737.25	7.71	0.33	736.92	8.04	5.49	2.62	734.63	8.11
MW59-4(3)	735.42	5.13	3.3	732.12	8.43	5.82	2.62	732.8	8.44
MW59-6(3)	741.27	7.53	4.92	736.35	12.45	5.6	7.1	734.17	12.7
MW59-7(4)	735.84	11.69	2.81	733.03	14.5	11.99	2.8	733.04	14.79
MW59-8(4)	737.51	8.67	4.55	732.96	13.22	7.88	4.6	732.91	12.48
MW71-1(2)	738.36	2.52	5.88	732.48	8.4	3.45	5.55	732.81	9
MW71-2(2)	741.79	0.46	6.44	735.35	6.9	2.26	3.94	737.85	6.2
MW71-3(2)	738.79	2.05	5.46	733.33	7.51	1.83	6.05	732.74	7.88
MW71-4(4)	746.37	9.92	10.75	735.62	20.67	11.2	9.75	736.62	20.95

- (1) Originally installed during ESI. Replaced due to damage during Phase I RI by Parsons.
- (2) Installed during ESI by Parsons.
- (3) Installed during Phase I RI.
- (4) Installed during TCRA by ENSR.
- (5) MW59-3, 59-4, 59-6, 59-7, 59-8, and 71-4 surveyed in June 2004.

Table 4-1A
SUMMARY STATISTICS - SURFACE SOIL (0-2 FT)
SEAD-59
SEAD-59 and SEAD-71 Phase II RI Report
Seneca Army Depot Activity

Parameter ⁽¹⁾	Units	Number of Analyses ⁽²⁾	Number of Detects	Frequency of Detection	Maximum Detect	NYSDEC TAGM 4046 ⁽³⁾	Number of Exceedences
Volatile Organic Compounds							
1,1-Dichloroethene	UG/KG	184	3	2%	8	400	0
Acetone	UG/KG	184	46	25%	550	200	2
Benzene	UG/KG	184	7	4%	1.75	60	0
Carbon disulfide	UG/KG	184	6	3%	4	2700	0
Cyclohexane	UG/KG	98	8	8%	3		0
Ethyl benzene	UG/KG	184	2	1%	3.15	5500	0
Meta/Para Xylene	UG/KG	70	3	4%	8.4		0
Methyl Acetate	UG/KG	98	3	3%	2		0
Methyl cyclohexane	UG/KG	98	10	10%	5		0
Methyl ethyl ketone	UG/KG	184	22	12%	190	300	0
Methyl isobutyl ketone	UG/KG	184	1	1%	1.9	1000	0
Methylene chloride	UG/KG	185	36	19%	4.9	100	0
Ortho Xylene	UG/KG	70	3	4%	3.6		0
Tetrachloroethene	UG/KG	184	5	3%	6.4	1400	0
Toluene	UG/KG	184	15	8%	8	1500	0
Total BTEX	MG/KG	10	9	90%	6.5		0
Total Xylenes	UG/KG	109	7	6%	3	1200	0
Trichloroethene	UG/KG	184	8	4%	4.5	700	0
Trichlorofluoromethane	UG/KG	98	1	1%	6		0
Semivolatile Organic Compounds							
1,1'-Biphenyl	UG/KG	99	2	2%	147		0
2-Methylnaphthalene	UG/KG	185	38	21%	970	36400	0
4-Chloroaniline	UG/KG	185	2	1%	1200	220	1
4-Methylphenol	UG/KG	185	5	3%	150	900	0
Acenaphthene	UG/KG	185	46	25%	2680	50000	0
Acenaphthylene	UG/KG	185	70	38%	1700	41000	0
Anthracene	UG/KG	185	81	44%	4395	50000	0
Atrazine	UG/KG	99	1	1%	120		0
Benzaldehyde	UG/KG	99	1	1%	50		0
Benzo(a)anthracene	UG/KG	185	96	52%	8900	224	72
Benzo(a)pyrene	UG/KG	185	97	52%	8050	61	88
Benzo(b)fluoranthene	UG/KG	185	99	54%	6800	1100	42
Benzo(ghi)perylene	UG/KG	185	88	48%	5200	50000	0
Benzo(k)fluoranthene	UG/KG	185	93	50%	7350	1100	35
Bis(2-Ethylhexyl)phthalate	UG/KG	185	38	21%	515	50000	0
Butylbenzylphthalate	UG/KG	185	1	1%	1000	50000	0
Carbazole	UG/KG	115	25	22%	755		0
Chrysene	UG/KG	185	97	52%	8900	400	65
Di-n-butylphthalate	UG/KG	185	8	4%	490	8100	0
Di-n-octylphthalate	UG/KG	185	1	1%	11	50000	0
Dibenz(a,h)anthracene	UG/KG	185	72	39%	1665	14	71
Dibenzofuran	UG/KG	185	32	17%	1875	6200	0
Diethyl phthalate	UG/KG	185	4	2%	12	7100	0
Fluoranthene	UG/KG	185	103	56%	23500	50000	0
Fluorene	UG/KG	185	53	29%	2640	50000	0
Indeno(1,2,3-cd)pyrene	UG/KG	185	90	49%	4950	3200	2
N-Nitrosodiphenylamine	UG/KG	115	1	1%	100		0
Naphthalene	UG/KG	185	37	20%	1325	13000	0
Phenanthrene	UG/KG	185	96	52%	21300	50000	0
Pyrene	UG/KG	185	104	56%	19200	50000	0
Total Unknown PAHs as SV	MG/KG	9	7	78%	25		0
Pesticides/PCBs							
4,4'-DDD	UG/KG	185	50	27%	740	2900	0

Table 4-1A
SUMMARY STATISTICS - SURFACE SOIL (0-2 FT)
SEAD-59
SEAD-59 and SEAD-71 Phase II RI Report
Seneca Army Depot Activity

Parameter ⁽¹⁾	Units	Number of Analyses ⁽²⁾	Number of Detects	Frequency of Detection	Maximum Detect	NYSDEC TAGM 4046 ⁽³⁾	Number of Exceedences
4,4'-DDE	UG/KG	185	68	37%	2600	2100	1
4,4'-DDT	UG/KG	185	62	34%	3700	2100	1
Aldrin	UG/KG	185	1	1%	1.2	41	0
Alpha-BHC	UG/KG	185	1	1%	9	110	0
Alpha-Chlordane	UG/KG	185	8	4%	34		0
Aroclor-1260	UG/KG	185	2	1%	79	10000	0
Beta-BHC	UG/KG	185	3	2%	3.6	200	0
Delta-BHC	UG/KG	185	2	1%	1.4	300	0
Dieldrin	UG/KG	185	1	1%	1.8	44	0
Endosulfan I	UG/KG	185	1	1%	16	900	0
Endosulfan sulfate	UG/KG	185	1	1%	6.2	1000	0
Endrin	UG/KG	185	4	2%	16	100	0
Endrin aldehyde	UG/KG	185	3	2%	3.825		0
Endrin ketone	UG/KG	185	5	3%	38		0
Gamma-Chlordane	UG/KG	185	15	8%	24	540	0
Heptachlor epoxide	UG/KG	185	3	2%	3	20	0
Metals							
Aluminum	MG/KG	185	185	100%	18300	19300	0
Antimony	MG/KG	185	104	56%	424	5.9	5
Arsenic	MG/KG	185	185	100%	32.2	8.2	7
Barium	MG/KG	185	185	100%	304	300	1
Beryllium	MG/KG	185	183	99%	2.6	1.1	2
Cadmium	MG/KG	185	153	83%	3.2	2.3	2
Calcium	MG/KG	185	185	100%	214000	121000	1
Chromium	MG/KG	185	185	100%	39.3	29.6	2
Cobalt	MG/KG	185	185	100%	47.8	30	2
Copper	MG/KG	185	185	100%	305	33	20
Iron	MG/KG	185	185	100%	64000	36500	1
Lead	MG/KG	185	185	100%	164	24.8	80
Magnesium	MG/KG	185	185	100%	30200	21500	3
Manganese	MG/KG	185	185	100%	1290	1060	4
Mercury	MG/KG	185	174	94%	0.95	0.1	40
Nickel	MG/KG	185	185	100%	88.3	49	3
Potassium	MG/KG	185	185	100%	2290	2380	0
Selenium	MG/KG	185	19	10%	1.5	2	0
Silver	MG/KG	185	88	48%	2.9	0.75	62
Sodium	MG/KG	185	180	97%	4060	172	87
Thallium	MG/KG	185	51	28%	1.8	0.7	23
Vanadium	MG/KG	185	185	100%	28.5	150	0
Zinc	MG/KG	185	185	100%	341	110	19

NOTES:

- (1) - Only compounds that were detected were included in this list of parameters.
- (2) - Sample Duplicate pairs values were averaged and regarded as a single entity.
- (3) - NYSDEC Technical and Administrative Guidance Memorandum (TAGM) HWR-94-4046, Revised January 24, 1994

Table 4-1B
SUMMARY STATISTICS - SUB-SURFACE SOIL (2-15 FT)
SEAD-59
SEAD-59 and SEAD-71 Phase II RI Report
Seneca Army Depot Activity

Parameter ⁽¹⁾	Units	Number of Analyses ⁽²⁾	Number of Detects	Frequency of Detection	Maximum Detect	NYSDEC TAGM 4046 ⁽³⁾	Number of Exceedences
Volatile Organic Compounds							
Acetone	UG/KG	14	1	7%	30	200	0
Benzene	UG/KG	14	1	7%	5.75	60	0
Ethyl benzene	UG/KG	14	2	14%	110	5500	0
Methyl chloride	UG/KG	14	1	7%	3		0
Methyl ethyl ketone	UG/KG	14	3	21%	36	300	0
Methylene chloride	UG/KG	14	1	7%	1	100	0
Toluene	UG/KG	14	2	14%	10.75	1500	0
Total BTEX	MG/KG	8	7	88%	9.5		0
Total Xylenes	UG/KG	14	1	7%	72.75	1200	0
Semivolatile Organic Compounds							
2-Methylnaphthalene	UG/KG	14	8	57%	10000	36400	0
4-Methylphenol	UG/KG	14	2	14%	83	900	0
Acenaphthene	UG/KG	14	8	57%	1600	50000	0
Acenaphthylene	UG/KG	14	6	43%	460	41000	0
Anthracene	UG/KG	14	6	43%	2100	50000	0
Benzo(a)anthracene	UG/KG	14	8	57%	4200	224	4
Benzo(a)pyrene	UG/KG	14	8	57%	4600	61	5
Benzo(b)fluoranthene	UG/KG	14	9	64%	4400	1100	1
Benzo(ghi)perylene	UG/KG	14	7	50%	1400	50000	0
Benzo(k)fluoranthene	UG/KG	14	8	57%	4900	1100	1
Bis(2-Ethylhexyl)phthalate	UG/KG	14	11	79%	260	50000	0
Butylbenzylphthalate	UG/KG	14	1	7%	4.2	50000	0
Carbazole	UG/KG	14	6	43%	1500		0
Chrysene	UG/KG	14	9	64%	4400	400	2
Di-n-butylphthalate	UG/KG	14	5	36%	29	8100	0
Di-n-octylphthalate	UG/KG	14	1	7%	5.6	50000	0
Dibenz(a,h)anthracene	UG/KG	14	4	29%	84	14	3
Dibenzofuran	UG/KG	14	6	43%	1400	6200	0
Diethyl phthalate	UG/KG	14	5	36%	11	7100	0
Fluoranthene	UG/KG	14	9	64%	10000	50000	0
Fluorene	UG/KG	14	7	50%	3000	50000	0
Indeno(1,2,3-cd)pyrene	UG/KG	14	7	50%	1500	3200	0
Naphthalene	UG/KG	14	7	50%	290	13000	0
Phenanthrene	UG/KG	14	11	79%	8300	50000	0
Phenol	UG/KG	14	1	7%	17	30	0
Pyrene	UG/KG	13	10	77%	12000	50000	0
Total Unknown PAHs as SV	MG/KG	8	1	13%	25		0
Pesticides/PCBs							
4,4'-DDD	UG/KG	14	5	36%	70	2900	0
4,4'-DDE	UG/KG	14	7	50%	48	2100	0
4,4'-DDT	UG/KG	14	4	29%	59	2100	0
Alpha-BHC	UG/KG	14	1	7%	9.9	110	0
Alpha-Chlordane	UG/KG	14	1	7%	17		0
Beta-BHC	UG/KG	14	3	21%	3.4	200	0
Delta-BHC	UG/KG	14	2	14%	1.2	300	0
Endosulfan I	UG/KG	14	1	7%	4.1	900	0
Endosulfan II	UG/KG	14	1	7%	7.1	900	0
Endosulfan sulfate	UG/KG	14	1	7%	4.3	1000	0
Endrin aldehyde	UG/KG	14	2	14%	6.3		0
Gamma-Chlordane	UG/KG	14	1	7%	18	540	0
Heptachlor epoxide	UG/KG	14	2	14%	5.7	20	0
Metals							
Aluminum	MG/KG	14	14	100%	12600	19300	0
Antimony	MG/KG	14	3	21%	0.47	5.9	0
Arsenic	MG/KG	14	14	100%	6	8.2	0
Barium	MG/KG	14	14	100%	101	300	0

Table 4-1B
SUMMARY STATISTICS - SUB-SURFACE SOIL (2-15 FT)
SEAD-59
SEAD-59 and SEAD-71 Phase II RI Report
Seneca Army Depot Activity

Parameter ⁽¹⁾	Units	Number of Analyses ⁽²⁾	Number of Detects	Frequency of Detection	Maximum Detect	NYSDEC TAGM 4046 ⁽³⁾	Number of Exceedences
Beryllium	MG/KG	14	14	100%	0.52	1.1	0
Cadmium	MG/KG	14	5	36%	0.61	2.3	0
Calcium	MG/KG	14	14	100%	123000	121000	1
Chromium	MG/KG	14	14	100%	18.9	29.6	0
Cobalt	MG/KG	14	14	100%	14.2	30	0
Copper	MG/KG	14	14	100%	27	33	0
Iron	MG/KG	14	14	100%	28900	36500	0
Lead	MG/KG	14	14	100%	65.5	24.8	2
Magnesium	MG/KG	14	14	100%	34400	21500	1
Manganese	MG/KG	14	14	100%	836	1060	0
Mercury	MG/KG	13	5	38%	0.15	0.1	1
Nickel	MG/KG	14	14	100%	35.5	49	0
Potassium	MG/KG	14	14	100%	2520	2380	1
Selenium	MG/KG	14	2	14%	0.49	2	0
Sodium	MG/KG	14	14	100%	1150	172	5
Vanadium	MG/KG	14	14	100%	22	150	0
Zinc	MG/KG	14	14	100%	133	110	2

NOTES:

- (1) - Only compounds that were detected were included in this list of parameters.
- (2) - Sample Duplicate pairs values were averaged and regarded as a single entity.
- (3) - NYSDEC Technical and Administrative Guidance Memorandum (TAGM) HWR-94-4046, Revised January 24, 1994

Table 4-2A
SUMMARY STATISTICS - GROUNDWATER APRIL 2004
SEAD-59
SEAD-59 and SEAD-71 Phase II RI Report
Seneca Army Depot Activity

Parameter ⁽¹⁾	Units	Number of Analyses ⁽²⁾	Number of Detects	Frequency of Detection	Maximum Detect	Criteria Type ⁽³⁾	Criteria Level	Number of Exceedences
Volatile Organic Compounds								
Toluene	µg/L	5	1	20%	0.27	GA	5	0
Pesticides/PCBs								
4,4'-DDE	µg/L	5	2	40%	0.008	GA	0.2	0
4,4'-DDT	µg/L	5	1	20%	0.042	GA	0.2	0
Metals								
Aluminum	µg/L	5	4	80%	3250	SEC	50	3
Antimony	µg/L	5	4	80%	8.6	GA	3	4
Barium	µg/L	5	5	100%	120	GA	1000	0
Cadmium	µg/L	5	3	60%	0.518	GA	5	0
Calcium	µg/L	5	5	100%	169000			0
Chromium	µg/L	5	1	20%	3.54	GA	50	0
Cobalt	µg/L	5	2	40%	2.92			0
Copper	µg/L	5	3	60%	4.65	GA	200	0
Iron	µg/L	5	5	100%	3680	GA	300	2
Magnesium	µg/L	5	5	100%	27900			0
Manganese	µg/L	5	5	100%	314	SEC	50	3
Nickel	µg/L	5	3	60%	6.08	GA	100	0
Potassium	µg/L	5	5	100%	2400			0
Sodium	µg/L	5	5	100%	304000	GA	20000	5
Vanadium	µg/L	5	1	20%	5.26			0
Zinc	µg/L	5	5	100%	13.2	SEC	5000	0

NOTES:

- (1) - Only compounds that were detected were included in this list of parameters.
- (2) - Sample Duplicate pairs values were averaged and regarded as a single entity.
- (3) - NY State Class GA Groundwater Standard (TOGS 1.1.1, June 1998), except as noted below
 - (SEC) US EPA Secondary Drinking Water Regulation, non-enforceable (EPA 822-B-00-001, Summer 2000)

Table 4-2B
SUMMARY STATISTICS - GROUNDWATER AUGUST 2004
SEAD-59
SEAD-59 and SEAD-71 Phase II RI Report
Seneca Army Depot Activity

Parameter ⁽¹⁾	Units	Number of Analyses ⁽²⁾	Number of Detects	Frequency of Detection	Maximum Detect	Criteria Type ⁽³⁾	Criteria Level	Number of Exceedences
Volatile Organic Compounds								
1,1,1-Trichloroethane	µg/L	5	1	20%	0.45	GA	5	0
Semivolatile Organic Compounds								
Di-n-butylphthalate	µg/L	5	1	20%	2.3	GA	50	0
Metals								
Aluminum	µg/L	6	6	100%	372	SEC	50	6
Barium	µg/L	6	6	100%	132	GA	1000	0
Cadmium	µg/L	6	2	33%	0.9	GA	5	0
Calcium	µg/L	6	6	100%	146000			0
Chromium	µg/L	6	4	67%	3.1	GA	50	0
Cobalt	µg/L	6	2	33%	1.2			0
Copper	µg/L	6	2	33%	3.45	GA	200	0
Iron	µg/L	6	6	100%	666	GA	300	3
Lead	µg/L	6	4	67%	4.4	MCL	15	0
Magnesium	µg/L	6	6	100%	28800			0
Manganese	µg/L	6	6	100%	294	SEC	50	3
Mercury	µg/L	6	1	17%	0.0639	GA	0.7	0
Nickel	µg/L	6	5	83%	5.5	GA	100	0
Potassium	µg/L	6	6	100%	2320			0
Selenium	µg/L	2	1	50%	4.2	GA	10	0
Sodium	µg/L	6	6	100%	235000	GA	20000	6
Vanadium	µg/L	6	1	17%	2.945			0
Zinc	µg/L	6	6	100%	7.99	SEC	5000	0

NOTES:

- (1) - Only compounds that were detected were included in this list of parameters.
- (2) - Sample Duplicate pairs values were averaged and regarded as a single entity.
- (3) - NY State Class GA Groundwater Standard (TOGS 1.1.1, June 1998), except as noted below
 - (SEC) US EPA Secondary Drinking Water Regulation, non-enforceable (EPA 822-B-00-001, Summer 2000)
 - (MCL) US EPA Maximum Contaminant Limit, Source <http://www.epa.gov/safewater/mcl.html#inorganic.html>

Table 4-3
SUMMARY STATISTICS - SOIL
SEAD-59 STOCKPILE
SEAD-59 and SEAD-71 Phase II RI Report
Seneca Army Depot Activity

Parameter ⁽¹⁾	Units	Number of Analyses ⁽²⁾	Number of Detects	Frequency of Detection	Maximum Detect	NYSDEC TAGM 4046 ⁽³⁾	Number of Exceedences
Volatile Organic Compounds							
1,1,2-Trichloro-1,2,2-Trifluoroethane	µg/kg	53	1	2%	1.5		0
1,1-Dichloroethene	µg/kg	53	1	2%	1	400	0
Acetone	µg/kg	53	13	25%	69	200	0
Meta/Para Xylene	µg/kg	48	2	4%	2.3		0
Methyl ethyl ketone	µg/kg	53	5	9%	7	300	0
Methylene chloride	µg/kg	53	1	2%	3.45	100	0
Ortho Xylene	µg/kg	48	5	10%	1.9		0
Tetrachloroethene	µg/kg	53	3	6%	6.7	1400	0
Total Xylenes	µg/kg	5	1	20%	3	1200	0
Trichloroethene	µg/kg	53	4	8%	4.2	700	0
Semivolatile Organic Compounds							
1,1'-Biphenyl	µg/kg	5	1	20%	59		0
2-Methylnaphthalene	µg/kg	53	27	51%	1200	36400	0
Acenaphthene	µg/kg	53	46	87%	2400	50000	0
Acenaphthylene	µg/kg	53	52	98%	3500	41000	0
Anthracene	µg/kg	53	53	100%	6600	50000	0
Benzo(a)anthracene	µg/kg	53	53	100%	14000	224	52
Benzo(a)pyrene	µg/kg	53	53	100%	16000	61	53
Benzo(b)fluoranthene	µg/kg	53	53	100%	11000	1100	46
Benzo(ghi)perylene	µg/kg	53	53	100%	8000	50000	0
Benzo(k)fluoranthene	µg/kg	53	53	100%	13000	1100	46
Bis(2-Ethylhexyl)phthalate	µg/kg	53	3	6%	130	50000	0
Carbazole	µg/kg	5	4	80%	1100		0
Chrysene	µg/kg	53	53	100%	13000	400	52
Dibenz(a,h)anthracene	µg/kg	53	52	98%	2900	14	52
Dibenzofuran	µg/kg	53	33	62%	1300	6200	0
Fluoranthene	µg/kg	53	53	100%	29000	50000	0
Fluorene	µg/kg	53	47	89%	3100	50000	0
Indeno(1,2,3-cd)pyrene	µg/kg	53	53	100%	8000	3200	19
Naphthalene	µg/kg	53	33	62%	1200	13000	0
Pentachlorophenol	µg/kg	53	1	2%	660	1000	0
Phenanthrene	µg/kg	53	53	100%	17000	50000	0
Pyrene	µg/kg	53	53	100%	22000	50000	0
Pesticides/PCBs							
4,4'-DDD	µg/kg	53	33	62%	450	2900	0
4,4'-DDE	µg/kg	53	33	62%	230	2100	0
4,4'-DDT	µg/kg	53	37	70%	520	2100	0
Alpha-BHC	µg/kg	53	1	2%	4.4	110	0
Alpha-Chlordane	µg/kg	53	6	11%	27		0
Beta-BHC	µg/kg	53	1	2%	13	200	0
Endrin ketone	µg/kg	53	1	2%	15		0
Gamma-Chlordane	µg/kg	53	5	9%	21	540	0
Metals							
Aluminum	mg/kg	53	53	100%	13400	19300	0
Antimony	mg/kg	53	11	21%	43.9	5.9	3
Arsenic	mg/kg	53	53	100%	7.3	8.2	0
Barium	mg/kg	53	53	100%	135	300	0
Beryllium	mg/kg	53	53	100%	0.69	1.1	0
Cadmium	mg/kg	53	52	98%	1.2	2.3	0
Calcium	mg/kg	53	53	100%	100000	121000	0
Chromium	mg/kg	53	53	100%	35	29.6	3
Cobalt	mg/kg	53	53	100%	13.9	30	0
Copper	mg/kg	53	53	100%	51.8	33	14

Table 4-3
SUMMARY STATISTICS - SOIL
SEAD-59 STOCKPILE
SEAD-59 and SEAD-71 Phase II RI Report
Seneca Army Depot Activity

Parameter ⁽¹⁾	Units	Number of Analyses ⁽²⁾	Number of Detects	Frequency of Detection	Maximum Detect	NYSDEC TAGM 4046 ⁽³⁾	Number of Exceedences
Iron	mg/kg	53	53	100%	26500	36500	0
Lead	mg/kg	53	53	100%	1440	24.8	51
Magnesium	mg/kg	53	53	100%	26600	21500	1
Manganese	mg/kg	53	53	100%	1220	1060	2
Mercury	mg/kg	53	53	100%	0.52	0.1	9
Nickel	mg/kg	53	53	100%	56.6	49	1
Potassium	mg/kg	53	53	100%	1580	2380	0
Selenium	mg/kg	53	2	4%	0.72	2	0
Silver	mg/kg	53	9	17%	4.7	0.75	6
Sodium	mg/kg	53	53	100%	525	172	23
Thallium	mg/kg	53	27	51%	0.99	0.7	12
Vanadium	mg/kg	53	53	100%	35.4	150	0
Zinc	mg/kg	53	53	100%	185	110	6

NOTES:

- (1) - Only compounds that were detected were included in this list of parameters.
- (2) - Sample Duplicate pairs values were averaged and regarded as a single entity.
- (3) - NYSDEC Technical and Administrative Guidance Memorandum (TAGM) HWR-94-4046, Revised January 24, 1994

Table 4-4
Benzo(a)pyrene Toxicity Equivalent (BTE) Concentrations Greater than 10 mg/kg
SEAD-59 Stockpile
SEAD-59 and SEAD-71 Phase II RI Report
Seneca Army Depot Activity

Facility		SEAD-59	SEAD-59	SEAD-59	SEAD-59	SEAD-59	SEAD-59	SEAD-59	SEAD-59
Sample ID		WS-59-01-006-3	WS-59-01-006-9	WS-59-01-007-14	WS-59-01-007-8	WS-59-01-008-2	WS-59-01-008-3	WS-59-01-011-1	WS-59-01-011-2
Matrix		SOIL	SOIL	SOIL	SOIL	SOIL	SOIL	SOIL	SOIL
Sample ID		WS-59-01-006-3	WS-59-01-006-9	WS-59-01-007-14	WS-59-01-007-8	WS-59-01-008-2	WS-59-01-008-3	WS-59-01-011-1	WS-59-01-011-2
Stockpile Location		North Staging	North Staging	North Staging	North Staging	Building 128	Building 128	Additional Staging	Additional Staging
Sample Date		5/6/2004	5/6/2004	5/6/2004	5/6/2004	5/6/2004	5/6/2004	5/6/2004	5/6/2004
Benzo(a)anthracene	UG/KG	5300	5600	13000	6900	8400	7800	8200	6900
Benzo(a)pyrene	UG/KG	6900	7400	14000	8200	11000	9400	9500	7400
Benzo(b)fluoranthene	UG/KG	4600	5400	9800	5800	7300	6700	10000	8100
Benzo(k)fluoranthene	UG/KG	4300	5400	11000	6300	7200	6500	4200	3200
Chrysene	UG/KG	5400	5700	13000	7000	8500	7900	8000	6600
Dibenz(a,h)anthracene	UG/KG	1600 J	1500 J	2500 J	1600 J	2200 J	1900 J	1600 J	1200 J
Indeno(1,2,3-cd)pyrene	UG/KG	4500 J	4700 J	7000 J	4100 J	5900 J	5200 J	5800	4500
BTE Concentration	UG/KG	10037	10581	19720	11613	15517	13414	13622	10648
BTE Concentration	MG/KG	10.037	10.581	19.72	11.613	15.517	13.414	13.622	10.648

Facility		SEAD-59	SEAD-59	SEAD-59	SEAD-59	SEAD-59	SEAD-59	SEAD-59
Sample ID		WS-59-01-011-7	WS-59-01-011-8	WS-59-01-011-9	WS-59-01-012-3	WS-59-01-016-1	WS-59-01-016-14	WS-59-01-016-20
Matrix		SOIL	SOIL	SOIL	SOIL	SOIL	SOIL	SOIL
Sample ID		WS-59-01-011-7	WS-59-01-011-8	WS-59-01-011-9	WS-59-01-012-3	WS-59-01-016-1	WS-59-01-016-14	WS-59-01-016-20
Stockpile Location		Additional Staging	Additional Staging	Additional Staging	Additional Staging	South Staging	South Staging	South Staging
Sample Date		5/6/2004	5/6/2004	5/6/2004	5/6/2004	5/6/2004	5/6/2004	5/6/2004
Benzo(a)anthracene	UG/KG	14000	12000	7700	10000	8200	8400	6800
Benzo(a)pyrene	UG/KG	16000	15000	9900	16000	7600	7300	8500
Benzo(b)fluoranthene	UG/KG	11000	11000	7700	11000	6400	5300	6400
Benzo(k)fluoranthene	UG/KG	13000	11000	7600	13000	6700	5800	6500
Chrysene	UG/KG	13000	12000	7700	11000	9000	7900	7500
Dibenz(a,h)anthracene	UG/KG	2800 J	2600 J	1900 J	2900 J	1200 J	1300 J	1800 J
Indeno(1,2,3-cd)pyrene	UG/KG	8000 J	7000 J	5100 J	7800 J	3400 J	3700 J	5000 J
BTE Concentration	UG/KG	22360	20830	14003	22020	10757	10477	12260
BTE Concentration	MG/KG	22.36	20.83	14.003	22.02	10.757	10.477	12.26

Site wide Average BTE Concentration (mg/kg)	8.07
--	-------------

Table 4-5A
SUMMARY STATISTICS - SURFACE SOIL (0-2 FT)
SEAD-71
SEAD-59 and SEAD-71 Phase II RI Report
Seneca Army Depot Activity

Parameter ⁽¹⁾	Units	Number of Analyses ⁽²⁾	Number of Detects	Frequency of Detection	Maximum Detect	NYSDEC TAGM 4046 ⁽³⁾	Number of Exceedences
Volatile Organic Compounds							
1,1,1-Trichloroethane	µg/kg	68	2	3%	3	800	0
Acetone	µg/kg	68	9	13%	74	200	0
Benzene	µg/kg	68	2	3%	2	60	0
Carbon disulfide	µg/kg	68	3	4%	5	2700	0
Cyclohexane	µg/kg	23	2	9%	4		0
Ethyl benzene	µg/kg	68	2	3%	4	5500	0
Methyl cyclohexane	µg/kg	23	3	13%	6		0
Methylene chloride	µg/kg	68	8	12%	11	100	0
Styrene	µg/kg	47	1	2%	1		0
Tetrachloroethene	µg/kg	68	1	1%	33	1400	0
Toluene	µg/kg	68	11	16%	16	1500	0
Total BTEX	mg/kg	1	1	100%	11.6		0
Total Xylenes	µg/kg	44	5	11%	11	1200	0
Trichlorofluoromethane	µg/kg	23	1	4%	1		0
Semivolatile Organic Compounds							
2,4-Dinitrotoluene	µg/kg	69	1	1%	880		0
2-Methylnaphthalene	µg/kg	69	15	22%	19000	36400	0
4-Nitroaniline	µg/kg	47	1	2%	75		0
Acenaphthene	µg/kg	69	29	42%	42000	50000	0
Acenaphthylene	µg/kg	69	19	28%	1800	41000	0
Anthracene	µg/kg	69	41	59%	100000	50000	3
Benzo(a)anthracene	µg/kg	69	53	77%	150000	224	40
Benzo(a)pyrene	µg/kg	69	53	77%	120000	61	47
Benzo(b)fluoranthene	µg/kg	69	54	78%	88000	1100	23
Benzo(ghi)perylene	µg/kg	69	48	70%	62000	50000	1
Benzo(k)fluoranthene	µg/kg	69	42	61%	130000	1100	20
Bis(2-Ethylhexyl)phthalate	µg/kg	69	6	9%	140	50000	0
Carbazole	µg/kg	47	27	57%	77000		0
Chrysene	µg/kg	69	56	81%	150000	400	37
Di-n-butylphthalate	µg/kg	69	4	6%	140	8100	0
Dibenz(a,h)anthracene	µg/kg	69	40	58%	25000	14	40
Dibenzofuran	µg/kg	69	27	39%	38000	6200	4
Fluoranthene	µg/kg	69	58	84%	440000	50000	6
Fluorene	µg/kg	69	28	41%	62000	50000	1
Indeno(1,2,3-cd)pyrene	µg/kg	69	48	70%	65000	3200	11
Naphthalene	µg/kg	69	15	22%	46000	13000	1
Phenanthrene	µg/kg	69	54	78%	290000	50000	5
Phenol	µg/kg	69	1	1%	4.5	30	0
Pyrene	µg/kg	69	56	81%	280000	50000	6
Pesticides/PCBs							
4,4'-DDD	µg/kg	69	18	26%	240	2900	0
4,4'-DDE	µg/kg	69	29	42%	810	2100	0
4,4'-DDT	µg/kg	69	35	51%	1300	2100	0
Alpha-BHC	µg/kg	69	5	7%	14	110	0
Alpha-Chlordane	µg/kg	69	1	1%	2		0
Beta-BHC	µg/kg	69	6	9%	35	200	0
Dieldrin	µg/kg	69	2	3%	3.4	44	0
Endosulfan I	µg/kg	69	7	10%	15	900	0
Endosulfan II	µg/kg	69	3	4%	52	900	0
Endosulfan sulfate	µg/kg	69	11	16%	110	1000	0
Endrin	µg/kg	69	10	14%	120	100	1
Endrin aldehyde	µg/kg	69	16	23%	120		0
Endrin ketone	µg/kg	69	15	22%	180		0
Gamma-Chlordane	µg/kg	69	4	6%	48	540	0
Heptachlor epoxide	µg/kg	69	12	17%	180	20	4

Table 4-5A
SUMMARY STATISTICS - SURFACE SOIL (0-2 FT)
SEAD-71
SEAD-59 and SEAD-71 Phase II RI Report
Seneca Army Depot Activity

Parameter ⁽¹⁾	Units	Number of Analyses ⁽²⁾	Number of Detects	Frequency of Detection	Maximum Detect	NYSDEC TAGM 4046 ⁽³⁾	Number of Exceedences
Methoxychlor	µg/kg	69	11	16%	520		0
Aroclor-1260	µg/kg	69	3	4%	200	10000	0
Metals							
Aluminum	mg/kg	69	69	100%	18000	19300	0
Antimony	mg/kg	69	34	49%	19.3	5.9	5
Arsenic	mg/kg	69	69	100%	14.6	8.2	5
Barium	mg/kg	69	69	100%	179	300	0
Beryllium	mg/kg	69	68	99%	0.88	1.1	0
Cadmium	mg/kg	69	46	67%	12.1	2.3	4
Calcium	mg/kg	69	69	100%	295000	121000	11
Chromium	mg/kg	69	69	100%	60.3	29.6	5
Cobalt	mg/kg	69	69	100%	14.6	30	0
Copper	mg/kg	69	69	100%	134	33	21
Iron	mg/kg	69	69	100%	65100	36500	2
Lead	mg/kg	69	69	100%	3470	24.8	33
Magnesium	mg/kg	69	69	100%	59300	21500	6
Manganese	mg/kg	69	69	100%	1330	1060	1
Mercury	mg/kg	69	55	80%	2.7	0.1	10
Nickel	mg/kg	69	69	100%	110	49	2
Potassium	mg/kg	69	69	100%	2180	2380	0
Selenium	mg/kg	69	13	19%	1.8	2	0
Silver	mg/kg	69	27	39%	2.2	0.75	15
Sodium	mg/kg	69	67	97%	1040	172	19
Thallium	mg/kg	69	18	26%	2.3	0.7	10
Vanadium	mg/kg	69	69	100%	29.2	150	0
Zinc	mg/kg	69	68	99%	3660	110	17

NOTES:

- (1) - Only compounds that were detected were included in this list of parameters.
- (2) - Sample Duplicate pairs values were averaged and regarded as a single entity.
- (3) - NYSDEC Technical and Administrative Guidance Memorandum (TAGM) HWR-94-4046, Revised January 24, 1994

Table 4-5B
SUMMARY STATISTICS - SUB-SURFACE SOIL (2-15 FT)
SEAD-71
SEAD-59 and SEAD-71 Phase II RI Report
Seneca Army Depot Activity

Parameter ⁽¹⁾	Units	Number of Analyses ⁽²⁾	Number of Detects	Frequency of Detection	Maximum Detect	NYSDEC TAGM 4046 ⁽³⁾	Number of Exceedences
Volatile Organic Compounds							
1,1,1-Trichloroethane	µg/kg	8	5	63%	23	800	0
Methylene chloride	µg/kg	8	4	50%	2	100	0
Tetrachloroethene	µg/kg	8	3	38%	3	1400	0
Total BTEX	mg/kg	3	3	100%	3.5		0
Total Xylenes	µg/kg	8	1	13%	96	1200	0
Semivolatile Organic Compounds							
2-Methylnaphthalene	µg/kg	8	2	25%	31000	36400	0
Acenaphthene	µg/kg	8	5	63%	13000	50000	0
Acenaphthylene	µg/kg	8	1	13%	340	41000	0
Anthracene	µg/kg	8	5	63%	11000	50000	0
Benzo(a)anthracene	µg/kg	8	7	88%	37000	224	4
Benzo(a)pyrene	µg/kg	8	7	88%	22000	61	5
Benzo(b)fluoranthene	µg/kg	8	7	88%	26000	1100	1
Benzo(ghi)perylene	µg/kg	8	6	75%	10000	50000	0
Benzo(k)fluoranthene	µg/kg	8	7	88%	15000	1100	1
Bis(2-Ethylhexyl)phthalate	µg/kg	8	3	38%	15	50000	0
Carbazole	µg/kg	8	6	75%	9500		0
Chrysene	µg/kg	8	7	88%	36000	400	3
Dibenz(a,h)anthracene	µg/kg	8	5	63%	9800	14	4
Dibenzofuran	µg/kg	8	2	25%	11000	6200	1
Fluoranthene	µg/kg	8	7	88%	88000	50000	1
Fluorene	µg/kg	8	4	50%	4100	50000	0
Indeno(1,2,3-cd)pyrene	µg/kg	8	6	75%	12000	3200	1
Naphthalene	µg/kg	8	3	38%	17000	13000	1
Phenanthrene	µg/kg	8	6	75%	66000	50000	1
Pyrene	µg/kg	8	7	88%	63000	50000	1
Pesticides/PCBs							
4,4'-DDE	µg/kg	8	2	25%	4.2	2100	0
4,4'-DDT	µg/kg	8	3	38%	13	2100	0
Alpha-BHC	µg/kg	8	3	38%	18	110	0
Alpha-Chlordane	µg/kg	8	1	13%	74		0
Beta-BHC	µg/kg	8	2	25%	2.7	200	0
Delta-BHC	µg/kg	8	1	13%	1.8	300	0
Dieldrin	µg/kg	8	1	13%	3.5	44	0
Endosulfan I	µg/kg	8	4	50%	200	900	0
Endosulfan II	µg/kg	8	2	25%	26	900	0
Endrin	µg/kg	8	2	25%	29	100	0
Endrin aldehyde	µg/kg	8	2	25%	7.2		0
Endrin ketone	µg/kg	8	1	13%	2.2		0
Gamma-BHC/Lindane	µg/kg	8	1	13%	4	60	0
Gamma-Chlordane	µg/kg	8	1	13%	1.1	540	0
Heptachlor	µg/kg	8	1	13%	1.2	100	0
Heptachlor epoxide	µg/kg	8	1	13%	1.5	20	0
Methoxychlor	µg/kg	8	1	13%	19		0
Metals							
Aluminum	mg/kg	8	8	100%	14500	19300	0
Antimony	mg/kg	8	2	25%	0.47	5.9	0
Arsenic	mg/kg	8	8	100%	5.4	8.2	0
Barium	mg/kg	8	8	100%	94.1	300	0
Beryllium	mg/kg	8	8	100%	0.58	1.1	0
Cadmium	mg/kg	8	4	50%	0.53	2.3	0
Calcium	mg/kg	8	8	100%	134000	121000	1
Chromium	mg/kg	8	8	100%	21.2	29.6	0
Cobalt	mg/kg	8	8	100%	11	30	0

Table 4-5B
SUMMARY STATISTICS - SUB-SURFACE SOIL (2-15 FT)
SEAD-71
SEAD-59 and SEAD-71 Phase II RI Report
Seneca Army Depot Activity

Parameter ⁽¹⁾	Units	Number of Analyses ⁽²⁾	Number of Detects	Frequency of Detection	Maximum Detect	NYSDEC TAGM 4046 ⁽³⁾	Number of Exceedences
Copper	mg/kg	8	8	100%	26.7	33	0
Iron	mg/kg	8	8	100%	23600	36500	0
Lead	mg/kg	8	8	100%	96.9	24.8	3
Magnesium	mg/kg	8	8	100%	10100	21500	0
Manganese	mg/kg	8	8	100%	784	1060	0
Mercury	mg/kg	8	4	50%	0.03	0.1	0
Nickel	mg/kg	8	8	100%	28	49	0
Potassium	mg/kg	8	8	100%	2940	2380	1
Selenium	mg/kg	8	2	25%	1.2	2	0
Sodium	mg/kg	8	6	75%	140	172	0
Vanadium	mg/kg	8	8	100%	24.9	150	0
Zinc	mg/kg	8	8	100%	96.2	110	0

NOTES:

- (1) - Only compounds that were detected were included in this list of parameters.
- (2) - Sample Duplicate pairs values were averaged and regarded as a single entity.
- (3) - NYSDEC Technical and Administrative Guidance Memorandum (TAGM) HWR-94-4046, Revised January 24, 1994

Table 4-5C
SUMMARY STATISTICS - SURFACE SOIL (0-2 FT) INSIDE SEAD-71 FENCED AREA
SEAD-59 and SEAD-71 Phase II RI Report
Seneca Army Depot Activity

Parameter ⁽¹⁾	Units	Number of Analyses ⁽²⁾	Number of Detects	Frequency of Detection	Maximum Detect	NYSDEC TAGM 4046 ⁽³⁾	Number of Exceedences
Volatile Organic Compounds							
1,1,1-Trichloroethane	µg/kg	15	1	7%	3	800	0
Ethyl benzene	µg/kg	15	2	13%	4	5,500	0
Methylene chloride	µg/kg	15	4	27%	11	100	0
Styrene	µg/kg	15	1	7%	1		0
Tetrachloroethene	µg/kg	15	1	7%	33	1,400	0
Toluene	µg/kg	15	7	47%	16	1,500	0
Total Xylenes	µg/kg	15	2	13%	11	1,200	0
Semivolatile Organic Compounds							
2-Methylnaphthalene	µg/kg	15	5	33%	19,000	36,400	0
Acenaphthene	µg/kg	15	11	73%	42,000	50,000	0
Anthracene	µg/kg	15	11	73%	100,000	50,000	3
Benzo(a)anthracene	µg/kg	15	14	93%	150,000	224	13
Benzo(a)pyrene	µg/kg	15	14	93%	120,000	61	14
Benzo(b)fluoranthene	µg/kg	15	14	93%	88,000	1,100	11
Benzo(ghi)perylene	µg/kg	15	14	93%	62,000	50,000	1
Benzo(k)fluoranthene	µg/kg	15	13	87%	130,000	1,100	10
Carbazole	µg/kg	15	11	73%	77,000		0
Chrysene	µg/kg	15	14	93%	150,000	400	12
Di-n-butylphthalate	µg/kg	15	1	7%	140	8,100	0
Dibenz(a,h)anthracene	µg/kg	15	13	87%	25,000	14	13
Dibenzofuran	µg/kg	15	11	73%	38,000	6,200	4
Fluoranthene	µg/kg	15	15	100%	440,000	50,000	6
Fluorene	µg/kg	15	11	73%	62,000	50,000	1
Indeno(1,2,3-cd)pyrene	µg/kg	15	14	93%	65,000	3,200	7
Naphthalene	µg/kg	15	5	33%	46,000	13,000	1
Phenanthrene	µg/kg	15	15	100%	290,000	50,000	5
Pyrene	µg/kg	15	15	100%	280,000	50,000	6
Pesticides/PCBs							
4,4'-DDD	µg/kg	15	9	60%	240	2,900	0
4,4'-DDE	µg/kg	15	9	60%	810	2,100	0
4,4'-DDT	µg/kg	15	10	67%	1,300	2,100	0
Alpha-BHC	µg/kg	15	3	20%	14	110	0
Alpha-Chlordane	µg/kg	15	1	7%	2		0
Beta-BHC	µg/kg	15	6	40%	35	200	0
Endosulfan I	µg/kg	15	7	47%	15	900	0
Endosulfan II	µg/kg	15	3	20%	52	900	0
Endosulfan sulfate	µg/kg	15	7	47%	110	1,000	0
Endrin	µg/kg	15	7	47%	120	100	1
Endrin aldehyde	µg/kg	15	9	60%	120		0
Endrin ketone	µg/kg	15	9	60%	180		0
Gamma-Chlordane	µg/kg	15	3	20%	48	540	0
Heptachlor epoxide	µg/kg	15	8	53%	180	20	4
Methoxychlor	µg/kg	15	9	60%	520		0
Metals							
Aluminum	mg/kg	15	15	100%	18,000	19,300	0
Antimony	mg/kg	15	7	47%	19.3	5.9	1
Arsenic	mg/kg	15	15	100%	11.5	8.2	3
Barium	mg/kg	15	15	100%	179	300	0
Beryllium	mg/kg	15	14	93%	0.88	1.1	0
Cadmium	mg/kg	15	10	67%	12.1	2.3	4
Calcium	mg/kg	15	15	100%	261,000	121,000	9
Chromium	mg/kg	15	15	100%	60.3	29.6	4
Cobalt	mg/kg	15	15	100%	14.6	30	0
Copper	mg/kg	15	15	100%	134	33	7
Iron	mg/kg	15	15	100%	65,100	36,500	1

Table 4-5C
SUMMARY STATISTICS - SURFACE SOIL (0-2 FT) INSIDE SEAD-71 FENCED AREA
SEAD-59 and SEAD-71 Phase II RI Report
Seneca Army Depot Activity

Parameter ⁽¹⁾	Units	Number of Analyses ⁽²⁾	Number of Detects	Frequency of Detection	Maximum Detect	NYSDEC TAGM 4046 ⁽³⁾	Number of Exceedences
Lead	mg/kg	15	15	100%	3,470	24.8	9
Magnesium	mg/kg	15	15	100%	34,300	21,500	5
Manganese	mg/kg	15	15	100%	749	1,060	0
Mercury	mg/kg	15	7	47%	2.7	0.1	3
Nickel	mg/kg	15	15	100%	98.8	49	1
Potassium	mg/kg	15	15	100%	1,830	2,380	0
Selenium	mg/kg	15	7	47%	1.8	2	0
Silver	mg/kg	15	5	33%	2.2	0.75	1
Sodium	mg/kg	15	14	93%	1,040	172	11
Vanadium	mg/kg	15	15	100%	29.2	150	0
Zinc	mg/kg	15	15	100%	3,660	110	7

NOTES:

- (1) - Only compounds that were detected in sample collected from within SEAD-71 Fenced Area were included in this list of parameters.
- (2) - Sample Duplicate pairs values were averaged and regarded as a single entity.
- (3) - NYSDEC Technical and Administrative Guidance Memorandum (TAGM) HWR-94-4046, Revised January 24, 1994

Table 4-6A
SUMMARY STATISTICS - GROUNDWATER APRIL 2004
SEAD-71
SEAD-59 and SEAD-71 Phase II RI Report
Seneca Army Depot Activity

Parameter ⁽¹⁾	Units	Number of Analyses ⁽²⁾	Number of Detects	Frequency of Detection	Maximum Detect	Criteria Type ⁽³⁾	Criteria Level	Number of Exceedences
Volatile Organic Compounds								
1,1,1-Trichloroethane	µg/L	3	1	33%	3.1	GA	5	0
Semivolatile Organic Compounds								
Bis(2-Ethylhexyl)phthalate	µg/L	3	1	33%	1.6	GA	5	0
Pesticides/PCBs								
4,4'-DDE	µg/L	3	2	67%	0.02225	GA	0.2	0
4,4'-DDT	µg/L	3	2	67%	0.043	GA	0.2	0
Endrin ketone	µg/L	3	1	33%	0.008	GA	5	0
Metals								
Aluminum	µg/L	4	1	25%	12200	SEC	50	1
Antimony	µg/L	4	3	75%	6.9	GA	3	3
Barium	µg/L	4	4	100%	62.85	GA	1000	0
Beryllium	µg/L	4	1	25%	0.819	MCL	4	0
Calcium	µg/L	4	4	100%	218000			0
Chromium	µg/L	4	1	25%	4.58	GA	50	0
Cobalt	µg/L	4	1	25%	0.631			0
Copper	µg/L	4	2	50%	5.3	GA	200	0
Iron	µg/L	4	4	100%	4470	GA	300	1
Lead	µg/L	4	1	25%	7.3	MCL	15	0
Magnesium	µg/L	4	4	100%	28800			0
Manganese	µg/L	4	2	50%	76.7	SEC	50	1
Mercury	µg/L	4	2	50%	0.069	GA	0.7	0
Nickel	µg/L	4	1	25%	4.79	GA	100	0
Potassium	µg/L	4	4	100%	1090			0
Sodium	µg/L	4	4	100%	62200	GA	20000	3
Vanadium	µg/L	4	1	25%	3			0
Zinc	µg/L	4	4	100%	41.7	SEC	5000	0

NOTES:

- (1) - Only compounds that were detected were included in this list of parameters.
- (2) - Sample Duplicate pairs values were averaged and regarded as a single entity.
- (3) - NY State Class GA Groundwater Standard (TOGS 1.1.1, June 1998), except as noted below
 - (SEC) US EPA Secondary Drinking Water Regulation, non-enforceable (EPA 822-B-00-001, Summer 2000)
 - (MCL) US EPA Maximum Contaminant Limit, Source <http://www.epa.gov/safewater/mcl.html#inorganic.html>

Table 4-6B
SUMMARY STATISTICS - GROUNDWATER AUGUST 2004
SEAD-71
SEAD-59 and SEAD-71 Phase II RI Report
Seneca Army Depot Activity

Parameter ⁽¹⁾	Units	Number of Analyses ⁽²⁾	Number of Detects	Frequency of Detection	Maximum Detect	Criteria Type ⁽³⁾	Criteria Level	Number of Exceedences
Volatile Organic Compounds								
1,1,1-Trichloroethane	µg/L	3	1	33%	2.5	GA	5	0
Semivolatile Organic Compounds								
4-Nitroaniline	µg/L	3	1	33%	8.7	GA	5	1
Pesticides/PCBs								
4,4'-DDT	µg/L	3	1	33%	0.0437	GA	0.2	0
Metals								
Aluminum	µg/L	3	2	67%	146	SEC	50	2
Barium	µg/L	3	3	100%	121	GA	1000	0
Calcium	µg/L	3	3	100%	210000			0
Chromium	µg/L	3	1	33%	0.82	GA	50	0
Cobalt	µg/L	3	1	33%	1.2			0
Iron	µg/L	3	3	100%	148	GA	300	0
Lead	µg/L	3	1	33%	2.1	MCL	15	0
Magnesium	µg/L	3	3	100%	28400			0
Manganese	µg/L	3	3	100%	2680	SEC	50	1
Nickel	µg/L	3	3	100%	6.6	GA	100	0
Potassium	µg/L	3	3	100%	1150			0
Sodium	µg/L	3	3	100%	48200	GA	20000	1
Zinc	µg/L	3	3	100%	83.4	SEC	5000	0

NOTES:

- (1) - Only compounds that were detected were included in this list of parameters.
- (2) - Sample Duplicate pairs values were averaged and regarded as a single entity.
- (3) - NY State Class GA Groundwater Standard (TOGS 1.1.1, June 1998), except as noted below
 - (SEC) US EPA Secondary Drinking Water Regulation, non-enforceable (EPA 822-B-00-001, Summer 2000)
 - (MCL) US EPA Maximum Contaminant Limit, Source <http://www.epa.gov/safewater/mcl.html#inorganic.html>

TABLE 5-1
Relative Relationship Between Koc and Mobility
SEAD-59 and SEAD-71 Phase II RI Report
Seneca Army Depot Activity

Koc	Class	Mobility
>2,000	I	Immobile
500-2,000	II	Low Mobility
150-500	III	Intermediate Mobility
50-150	IV	Mobile
<50	V	Very Mobile

Notes:

- 1) Koc = Organic carbon partition coefficient
- 2) Source: Dragun, 1988.

TABLE 6-1
SELECTION OF EXPOSURE PATHWAYS
SEAD-59 and SEAD-71 Phase II RI
SENECA ARMY DEPOT ACTIVITY

Scenario Timeframe	Medium	Exposure Medium	Exposure Point	Receptor Population	Receptor Age	Exposure Route	On-Site/ Off-Site	Type of Analysis	Rationale for Selection or Exclusion of Exposure Pathway		
Current	Soil	Soil	SEAD-59/71	Construction Worker	Adult	Dermal Ingestion	On-Site On-Site	Quant Quant	Potential construction workers will be exposed to soil at the sites. Potential construction workers will be exposed to soil at the sites.		
				Industrial Worker	Adult	Dermal Ingestion	On-Site On-Site	None None	The sites are currently not in use and future industrial workers will be used as a surrogate. The sites are currently not in use and future industrial workers will be used as a surrogate.		
				Trespasser	Child	Dermal Ingestion	On-Site On-Site	Quant Quant	Trespasser may potentially be exposed to soil at the sites Trespasser may potentially be exposed to soil at the sites		
				Resident	Adult	Dermal Ingestion	On-Site On-Site	None None	The sites are currently not in use and no residents currently reside at the sites. The sites are currently not in use and no residents currently reside at the sites.		
					Child	Dermal Ingestion	On-Site On-Site	None None	The sites are currently not in use and no residents currently reside at the sites. The sites are currently not in use and no residents currently reside at the sites.		
				Air	SEAD-59/71	Construction Worker	Adult	Inhalation	On-Site	Quant	Potential construction workers will be exposed to soil dust.
						Industrial Worker	Adult	Inhalation	On-Site	None	The sites are currently not in use and future industrial workers will be used as a surrogate.
						Trespasser	Child	Inhalation	On-Site	Quant	Potential Trespasser receptor will be exposed to soil dust.
		Resident	Adult			Inhalation	On-Site	None	The sites are currently not in use and no residents currently reside at the sites.		
			Child	Inhalation	On-Site	None	The sites are currently not in use and no residents currently reside at the sites.				
		Produce	SEAD-59/71	Construction Worker	Adult	Ingestion	On-Site	None	No produce suitably for consumption is currently grown at the sites		
				Industrial Worker	Adult	Ingestion	On-Site	None	No produce suitably for consumption is currently grown at the sites		
				Trespasser	Child	Ingestion	On-Site	None	No produce suitably for consumption is currently grown at the sites		
				Resident	Adult	Ingestion	On-Site	None	No produce suitably for consumption is currently grown at the sites		
					Child	Ingestion	On-Site	None	No produce suitably for consumption is currently grown at the sites		

TABLE 6-1
SELECTION OF EXPOSURE PATHWAYS
SEAD-59 and SEAD-71 Phase II RI
SENECA ARMY DEPOT ACTIVITY

Scenario Timeframe	Medium	Exposure Medium	Exposure Point	Receptor Population	Receptor Age	Exposure Route	On-Site/ Off-Site	Type of Analysis	Rationale for Selection or Exclusion of Exposure Pathway
Current	Groundwater	Groundwater	Aquifer -- Tap Water	Construction Worker	Adult	Dermal Intake	On-Site On-Site	Quant None	Construction workers may potentially be exposed to groundwater at the sites. Groundwater is not currently used as drinking water sources.
				Industrial Worker	Adult	Dermal Intake	On-Site On-Site	None None	Groundwater is not currently used as drinking water sources. Groundwater is not currently used as drinking water sources.
				Trespasser	Child	Dermal Intake	On-Site On-Site	None None	Trespassers are not likely to contact groundwater Groundwater is not currently used as drinking water sources.
				Resident	Adult	Dermal	On-Site	None	The sites are currently not in use and no residents currently reside at the sites.
							Off-Site	None	Groundwater at Seneca Depot is not used as drinking water resources and impact to groundwater beyond the Depot is minimal.
					Intake	On-Site	None	The sites are currently not in use and no residents currently reside at the sites.	
						Off-Site	None	Groundwater at Seneca Depot is not used as drinking water resources and impact to groundwater beyond the Depot is minimal.	
				Child	Dermal	On-Site	None	The sites are currently not in use and no residents currently reside at the sites.	
Off-Site	None	Groundwater at Seneca Depot is not used as drinking water resources and impact to groundwater beyond the Depot is minimal.							
		Intake	On-Site	None	The sites are currently not in use and no residents currently reside at the sites.				
		Off-Site	None	Groundwater at Seneca Depot is not used as drinking water resources and impact to groundwater beyond the Depot is minimal.					

TABLE 6-1
SELECTION OF EXPOSURE PATHWAYS
SEAD-59 and SEAD-71 Phase II RI
SENECA ARMY DEPOT ACTIVITY

Scenario Timeframe	Medium	Exposure Medium	Exposure Point	Receptor Population	Receptor Age	Exposure Route	On-Site/ Off-Site	Type of Analysis	Rationale for Selection or Exclusion of Exposure Pathway
Future	Soil	Soil	SEAD-59/71	Construction Worker	Adult	Dermal Ingestion	On-Site On-Site	Quant Quant	Potential construction workers will be exposed to soil at the sites. Potential construction workers will be exposed to soil at the sites.
				Industrial Worker	Adult	Dermal Ingestion	On-Site On-Site	Quant Quant	Potential industrial workers will be exposed to soil at the sites. Potential industrial workers will be exposed to soil at the sites.
				Child Visitor	Child	Dermal Ingestion	On-Site On-Site	Quant Quant	Child visitor may potentiall be exposed to soil at the sites. Child visitor may potentiall be exposed to soil at the sites.
				Child at Day Care Center	Child	Dermal	On-Site	None	Future land use restricts development of residential homes, primary/secondary schools, and playgrounds/child-care facilities
					Child	Ingestion	On-Site	None	Future land use restricts development of residential homes, primary/secondary schools, and playgrounds/child-care facilities
				Resident	Adult	Dermal	On-Site	None	Future land use restricts development of residential homes, primary/secondary schools, and playgrounds/child-care facilities
					Adult	Ingestion	On-Site	None	Future land use restricts development of residential homes, primary/secondary schools, and playgrounds/child-care facilities
				Child	Dermal	On-Site	None	Future land use restricts development of residential homes, primary/secondary schools, and playgrounds/child-care facilities	
					Ingestion	On-Site	None	Future land use restricts development of residential homes, primary/secondary schools, and playgrounds/child-care facilities	
				Air	SEAD-59/71	Construction Worker	Adult	Inhalation	On-Site
		Industrial Worker	Adult			Inhalation	On-Site	Quant	Potential industrial workers will be exposed to soil dust.
		Child Visitor	Child			Inhalation	On-Site	Quant	Child visitor may potentially be exposed to soil at the sites.
		Child at Day Care Center	Child			Inhalation	On-Site	None	Future land use restricts development of residential homes, primary/secondary schools, and playgrounds/child-care facilities
		Resident	Adult			Inhalation	On-Site	None	Future land use restricts development of residential homes, primary/secondary schools, and playgrounds/child-care facilities
			Child			Inhalation	On-Site	None	Future land use restricts development of residential homes, primary/secondary schools, and playgrounds/child-care facilities
		Produce	SEAD-59/71	Construction Worker	Adult	Ingestion	On-Site	None	Produce suitably for consumption is unlikely to grow at the sites based on the future use.
				Industrial Worker	Adult	Ingestion	On-Site	None	Produce suitably for consumption is unlikely to grow at the sites based on the future use.
				Child Visitor	Child	Ingestion	On-Site	None	Produce suitably for consumption is unlikely to grow at the sites based on the future use.
				Child at Day Care Center	Child	Ingestion	On-Site	None	Future land use restricts development of residential homes, primary/secondary schools, and playgrounds/child-care facilities
				Resident	Adult	Ingestion	On-Site	None	Future land use restricts development of residential homes, primary/secondary schools, and playgrounds/child-care facilities
					Child	Ingestion	On-Site	None	Future land use restricts development of residential homes, primary/secondary schools, and playgrounds/child-care facilities

TABLE 6-1
SELECTION OF EXPOSURE PATHWAYS
SEAD-59 and SEAD-71 Phase II RI
SENECA ARMY DEPOT ACTIVITY

Scenario Timeframe	Medium	Exposure Medium	Exposure Point	Receptor Population	Receptor Age	Exposure Route	On-Site/ Off-Site	Type of Analysis	Rationale for Selection or Exclusion of Exposure Pathway
Future	Groundwater	Groundwater	Aquifer -- Tap Water	Construction Worker	Adult	Dermal	On-Site	Quant	Potential construction workers are not likely to be exposed to groundwater at the sites.
						Intake	On-Site	Quant	Groundwater is not currently used as drinking water sources. However, as no institutional control is available to prevent future use of groundwater, groundwater is assumed to be used as tap water as a conservative step.
				Industrial Worker	Adult	Dermal	On-Site	None	Industrial workers are assumed not to shower.
						Intake	On-Site	Quant	Groundwater is not currently used as drinking water sources. However, as no institutional control is available to prevent future use of groundwater, groundwater is assumed to be used as tap water as a conservative step.
				Child Visitor	Child	Dermal	On-Site	None	Child visitors are unlikely to contact groundwater at the sites.
						Intake	On-Site	Quant	Groundwater is not currently used as drinking water sources. However, as no institutional control is available to prevent future use of groundwater, groundwater is assumed to be used as tap water as a conservative step.
				Child at Day Care Center	Child	Dermal	On-Site	None	Future land use restricts development of residential homes, primary/secondary schools, and playgrounds/child-care facilities
						Intake	On-Site	None	Future land use restricts development of residential homes, primary/secondary schools, and playgrounds/child-care facilities
				Resident	Adult	Dermal	On-Site	None	Future land use restricts development of residential homes, primary/secondary schools, and playgrounds/child-care facilities
							Off-Site	None	Groundwater at Seneca Depot is not used as drinking water resources and impact to groundwater beyond the Depot is minimal.
Intake	On-Site	None	Future land use restricts development of residential homes, primary/secondary schools, and playgrounds/child-care facilities						
	Off-Site	None	Groundwater at Seneca Depot is not used as drinking water resources and impact to groundwater beyond the Depot is minimal.						
Child	Child	Dermal	On-Site	None	Future land use restricts development of residential homes, primary/secondary schools, and playgrounds/child-care facilities				
			Off-Site	None	Groundwater at Seneca Depot is not used as drinking water resources and impact to groundwater beyond the Depot is minimal.				
		Intake	On-Site	None	Future land use restricts development of residential homes, primary/secondary schools, and playgrounds/child-care facilities				
			Off-Site	None	Groundwater at Seneca Depot is not used as drinking water resources and impact to groundwater beyond the Depot is minimal.				

**TABLE 6-2A
OCCURRENCE, DISTRIBUTION AND SELECTION OF POTENTIAL CONCERN IN SEAD-59 SITE SOIL
SEAD-59 AND SEAD-71 PHASE II RI
Seneca Army Depot Activity**

Scenario Time frame:	Current/Future
Medium:	Soil
Exposure Medium:	Soil
Exposure Point:	SEAD-59

CAS Number	Chemical	Minimum Detected Concentration ¹ (mg/kg)	Q	Maximum Detected Concentration ¹ (mg/kg)	Q	Location of Maximum Concentration	Detection Frequency ¹	Range of Reporting Limits ¹ (mg/kg)	Concentration Used for Screening ² (mg/kg)	Background Value ³ (mg/kg)	Screening Value ⁴ (mg/kg)	Potential ARAR/TBC Value	Potential ARAR/TBC Source	Potential ARAR/TBC Value ⁵ (mg/kg)	COPC Flag	Rationale for Contaminant Deletion or Selection ⁶
VOC																
75-35-4	1,1-Dichloroethene	0.001	J	0.008	J	CL-59-01-WS5	3 / 198	2 0.004 - 60 0.12	0.008		120	400	NYSDEC TAGM	0.4	NO	BSL
67-64-1	Acetone	0.004	J	0.55	NJ	CL-59-01-WE4	47 / 198	2 0.004 - 60 0.12	0.55		14,000	200	NYSDEC TAGM	0.2	NO	BSL
71-43-2	Benzene	0.001	J	0.0058	J	SB59-17	8 / 198	2 0.004 - 60 0.12	0.0058		0.64	60	NYSDEC TAGM	0.06	NO	BSL
75-15-0	Carbon disulfide	0.001	J	0.004	J	SB59-4	6 / 198	2 0.004 - 60 0.12	0.004		360	2700	NYSDEC TAGM	2.7	NO	BSL
110-82-7	Cyclohexane	0.001	J	0.003	J	WS-59-04-010-5	8 / 98	2 0.004 - 11.5 0.023	0.003		140				NO	BSL
100-41-4	Ethyl benzene	0.0023	J	0.11	J	TP59-13A-1	4 / 198	2 0.004 - 27.5 0.055	0.11		400	5500	NYSDEC TAGM	5.5	NO	BSL
	Meta/Para Xylene	0.0051	J	0.0084	J	WS-59-03-001-2	3 / 70	2.7 0.005 - 3.15 0.006	0.0084		270				NO	BSL
79-20-9	Methyl Acetate	0.001	J	0.002	J	CL-59-OTHERB-	3 / 98	2 0.004 - 11.5 0.023	0.002		22,000				NO	BSL
74-87-3	Methyl chloride	0.003	J	0.003	J	TP59-5	1 / 128	2 0.004 - 60 0.12	0.003		47				NO	BSL
108-87-2	Methyl cyclohexane	0.001	J	0.005	J	WS-59-04-010-5	10 / 98	2 0.004 - 11.5 0.023	0.005		2,600				NO	BSL
78-93-3	Methyl ethyl ketone	0.002	J	0.19	J	CL-59-01-WE4	25 / 198	2 0.004 - 60 0.12	0.19		22,000	300	NYSDEC TAGM	0.3	NO	BSL
108-10-1	Methyl isobutyl ketone	0.0019	J	0.0019	J	CL-59-OTHERC-WS1	1 / 198	2 0.004 - 60 0.12	0.0019		5,300	1000	NYSDEC TAGM	1	NO	BSL
75-09-2	Methylene chloride	0.001	J	0.0049	J	WS-59-01-018-1	37 / 199	2 0.004 - 60 0.12	0.0049		9.1	100	NYSDEC TAGM	0.1	NO	BSL
95-47-6	Ortho Xylene	0.0011	NJ	0.0036	J	FD-59-WS-01/WS-59-03-001-3	3 / 70	2.7 0.005 - 3.15 0.006	0.0036		270				NO	BSL
127-18-4	Tetrachloroethene	0.002	J	0.0064	J	WS-59-01-017-1	5 / 198	2 0.004 - 60 0.12	0.0064		0.48	1400	NYSDEC TAGM	1.4	NO	BSL
108-88-3	Toluene	0.0009	J	0.011	J	SB59-17	17 / 198	2 0.004 - 60 0.12	0.011		520	1500	NYSDEC TAGM	1.5	NO	BSL
	Total BTEX	0.0025		0.0095		TP59-13C-1	16 / 18	1.25 1.25 - 1.25 1.25	0.0095						NO	ICE
133-02-07	Total Xylenes	0.001	J	0.073	J	SB59-17	8 / 123	2 0.004 - 60 0.12	0.073		270	1200	NYSDEC TAGM	1.2	NO	BSL
79-01-6	Trichloroethene	0.001	J	0.0045	J	WS-59-01-006-4	8 / 198	2 0.004 - 60 0.12	0.0045		0.053	700	NYSDEC TAGM	0.7	NO	BSL
75-69-4	Trichlorofluoromethane	0.006	J	0.006	J	WS-59-04-010-6	1 / 98	2 0.004 - 11.5 0.023	0.006		390				NO	BSL
SVOC																
92-52-4	1,1'-Biphenyl	0.059	NJ	0.15	J	FD-59-WS-6/WS-59-01-012-1	2 / 99	175 0.35 - 950 1.9	0.15		3,000				NO	BSL
91-57-6	2-Methylnaphthalene	0.01	J	10		TP59-13A-1	46 / 199	33 0.066 - 2000 4	10		310	36400	NYSDEC TAGM	36.4	NO	BSL
106-47-8	4-Chloroaniline	0.13	J	1.2		CL-59-01-WN2	2 / 199	33 0.066 - 4000 8	1.2		240	220	NYSDEC TAGM	0.22	NO	BSL
106-44-5	4-Methylphenol	0.024	NJ	0.15	J	CL-59-01-WN5	7 / 199	33 0.066 - 4000 8	0.15		310	900	NYSDEC TAGM	0.9	NO	BSL
83-32-9	Acenaphthene	0.0061	J	2.68	J	FD-59-WS-07/WS-59-01-015-13	54 / 199	33 0.066 - 2000 4	2.68		3,700	50000	NYSDEC TAGM	50	NO	BSL
208-96-8	Acenaphthylene	0.0079	J	1.7	J	WS-59-01-006-11	76 / 199	33 0.066 - 4000 8	1.7			41000	NYSDEC TAGM	41	NO	NSV

**TABLE 6-2A
OCCURRENCE, DISTRIBUTION AND SELECTION OF CHEMICALS OF POTENTIAL CONCERN IN SEAD-59 SITE SOIL
SEAD-59 AND SEAD-71 PHASE II RI**

Seneca Army Depot Activity

Scenario Time frame:	Current/Future
Medium:	Soil
Exposure Medium:	Soil
Exposure Point:	SEAD-59

CAS Number	Chemical	Minimum Detected Concentration ¹ (mg/kg)	Q	Maximum Detected Concentration ¹ (mg/kg)	Q	Location of Maximum Concentration	Detection Frequency ¹	Range of Reporting Limits ¹ (mg/kg)			Concentration Used for Screening ² (mg/kg)	Background Value ³ (mg/kg)	Screening Value ⁴ (mg/kg)	Potential ARAR/TBC Value	Potential ARAR/TBC Source	Potential ARAR/TBC Value ⁵ (mg/kg)	COPC Flag	Rationale for Contaminant Deletion or Selection ⁶	
120-12-7	Anthracene	0.0084	J	4.395	J	FD-59-WS-07/WS-59-01-015-13	87 / 199	33	0.066	4000	8	4.395		22,000	50000	NYSDEC TAGM	50	NO	BSL
1912-24-9	Atrazine	0.12	J	0.12	J	CL-59-01-WN2	1 / 99	175	0.35	950	1.9	0.12		2.2				NO	BSL
100-52-7	Benzaldehyde	0.05	J	0.05	J	CL-59-01-WE4	1 / 99	175	0.35	950	1.9	0.05		6,100				NO	BSL
56-55-3	Benzo(a)anthracene	0.0038	J	8.9	J	FD-59-WS-07/WS-59-01-015-13	## / 199	34.5	0.069	4000	8	8.9		0.62	224	NYSDEC TAGM	0.224	YES	ASL
50-32-8	Benzo(a)pyrene	0.0036	J	8.05	J	FD-59-WS-07/WS-59-01-015-13	## / 199	34.5	0.069	4000	8	8.05		0.062	61	NYSDEC TAGM	0.061	YES	ASL
205-99-2	Benzo(b)fluoranthene	0.0038	J	6.8	J	FD-59-WS-07/WS-59-01-015-13	## / 199	39	0.078	4000	8	6.8		0.62	1100	NYSDEC TAGM	1.1	YES	ASL
191-24-2	Benzo(ghi)perylene	0.0063	J	5.2	J	FD-59-WS-07/WS-59-01-015-13	95 / 199	34.5	0.069	4000	8	5.2			50000	NYSDEC TAGM	50	NO	NSV
207-08-9	Benzo(k)fluoranthene	0.0037	J	7.35	J	FD-59-WS-07/WS-59-01-015-13	## / 199	34.5	0.069	4000	8	7.35		6.2	1100	NYSDEC TAGM	1.1	YES	ASL
117-81-7	Bis(2-Ethylhexyl)phthalate	0.007	J	0.52	J	SB59-1	49 / 199	175	0.35	4000	8	0.52		35	50000	NYSDEC TAGM	50	NO	BSL
85-68-7	Butylbenzylphthalate	0.0042	J	1	J	TP59-15-5	2 / 199	33	0.066	4000	8	1		12,000	50000	NYSDEC TAGM	50	NO	BSL
86-74-8	Carbazole	0.0066	J	1.5	J	TP59-2	31 / 129	34.5	0.069	4000	8	1.5		24				NO	BSL
218-01-9	Chrysene	0.0048	J	8.9	J	FD-59-WS-07/WS-59-01-015-13	## / 199	34.5	0.069	4000	8	8.9		62	400	NYSDEC TAGM	0.4	YES	CSG
53-70-3	Dibenz(a,h)anthracene	0.0047	J	1.665	J	FD-59-WS-07/WS-59-01-015-13	76 / 199	33	0.066	4000	8	1.665		0.062	14	NYSDEC TAGM	0.014	YES	ASL
132-64-9	Dibenzofuran	0.0056	J	1.875	J	FD-59-WS-07/WS-59-01-015-13	38 / 199	33	0.066	2000	4	1.875		150	6200	NYSDEC TAGM	6.2	NO	BSL
84-66-2	Diethylphthalate	0.0053	J	0.012	J	SB59-9	9 / 199	39	0.078	4000	8	0.012		49,000	7100	NYSDEC TAGM	7.1	NO	BSL
84-74-2	Di-n-butylphthalate	0.0048	J	0.49	J	SB59-1	13 / 199	38	0.076	4000	8	0.49		6,100	8100	NYSDEC TAGM	8.1	NO	BSL
117-84-0	Di-n-octylphthalate	0.0056	J	0.011	J	SB59-8	2 / 199	33	0.066	4000	8	0.011		2,400	50000	NYSDEC TAGM	50	NO	BSL
206-44-0	Fluoranthene	0.0048	J	23.5	J	FD-59-WS-07/WS-59-01-015-13	## / 199	34.5	0.069	4000	8	23.5		2,300	50000	NYSDEC TAGM	50	NO	BSL
86-73-7	Fluorene	0.0086	J	3	J	TP59-13A-1	60 / 199	33	0.066	2000	4	3		2,700	50000	NYSDEC TAGM	50	NO	BSL
193-39-5	Indeno(1,2,3-cd)pyrene	0.006	J	4.95	J	FD-59-WS-07/WS-59-01-015-13	97 / 199	34.5	0.069	4000	8	4.95		0.62	3200	NYSDEC TAGM	3.2	YES	ASL
91-20-3	Naphthalene	0.01	J	1.325	J	FD-59-WS-07/WS-59-01-015-13	44 / 199	33	0.066	4000	8	1.325		56	13000	NYSDEC TAGM	13	NO	BSL

**TABLE 6-2A
OCCURRENCE, DISTRIBUTION AND SELECTION OF CHEMICALS OF POTENTIAL CONCERN IN SEAD-59 SITE SOIL
SEAD-59 AND SEAD-71 PHASE II RI
Seneca Army Depot Activity**

Scenario Time frame:	Cuurent/Future
Medium:	Soil
Exposure Medium:	Soil
Exposure Point:	SEAD-59

CAS Number	Chemical	Minimum Detected Concentration ¹ (mg/kg)	Q	Maximum Detected Concentration ¹ (mg/kg)	Q	Location of Maximum Concentration	Detection Frequency ¹	Range of Reporting Limits ¹ (mg/kg)			Concentration Used for Screening ² (mg/kg)	Background Value ³ (mg/kg)	Screening Value ⁴ (mg/kg)	Potential ARAR/TBC Value	Potential ARAR/TBC Source	Potential ARAR / TBC Value ⁵ (mg/kg)	COPC Flag	Rationale for Contaminant Deletion or Selection ⁶	
86-30-6	N-Nitrosodiphenylamine	0.1	J	0.1	J	CL-59-01-WN2	1 / 129	33	0.066	4000	8	0.1		99			NO	BSL	
85-01-8	Phenanthrene	0.0046	J	21.3	J	FD-59-WS-07/WS-59-01-015-13	## / 199	34.5	0.069	230	0.46	21.3		50000	NYSDEC TAGM	50	NO	NSV	
108-95-2	Phenol	0.017	J	0.017	J	TP59-6-2	1 / 199	33	0.066	4000	8	0.017	18,000	30	NYSDEC TAGM	0.03	NO	BSL	
129-00-0	Pyrene	0.0051	J	19.2	J	FD-59-WS-07/WS-59-01-015-13	## / 198	34.5	0.069	4000	8	19.2	2,300	50000	NYSDEC TAGM	50	NO	BSL	
PCB																			
11096-82-5	Aroclor-1260	0.077		0.079	NJ	CL-59-OTHERC-WE2	2 / 199	17.5	0.035	210	0.42	0.079		0.22	10000	NYSDEC TAGM	10	NO	BSL
Pesticides																			
72-54-8	4,4'-DDD	0.0025	J	0.74	J	CL-59-01-WN2	55 / 199	1.7	0.003	49.5	0.099	0.74		2.4	2900	NYSDEC TAGM	2.9	NO	BSL
72-55-9	4,4'-DDE	0.0018	J	2.6	J	CL-59-01-WN2	75 / 199	1.7	0.003	49.5	0.099	2.6		1.7	2100	NYSDEC TAGM	2.1	YES	ASL
50-29-3	4,4'-DDT	0.0024	J	3.7	J	CL-59-01-WN2	66 / 199	1.7	0.003	49.5	0.099	3.7		1.7	2100	NYSDEC TAGM	2.1	YES	ASL
309-00-2	Aldrin	0.0012	J	0.0012	J	SB59-2	1 / 199	0.9	0.002	110	0.22	0.0012		0.029	41	NYSDEC TAGM	0.041	NO	BSL
319-84-6	Alpha-BHC	0.009		0.0099	J	MW59-4	2 / 199	0.9	0.002	110	0.22	0.0099		0.09	110	NYSDEC TAGM	0.11	NO	BSL
5103-71-9	Alpha-Chlordane	0.0011	J	0.034	J	WS-59-04-010-10	9 / 199	0.9	0.002	110	0.22	0.034		1.6			NO	BSL	
319-85-7	Beta-BHC	0.0024	J	0.0036	J	SB59-8	6 / 199	0.9	0.002	110	0.22	0.0036		0.32	200	NYSDEC TAGM	0.2	NO	BSL
319-86-8	Delta-BHC	0.00095	J	0.0014	J	SB59-8	4 / 199	0.9	0.002	110	0.22	0.0014		0.09	300	NYSDEC TAGM	0.3	NO	BSL
60-57-1	Dieldrin	0.0018	J	0.0018	J	TP59-8-2	1 / 199	1.7	0.003	215	0.43	0.0018		0.030	44	NYSDEC TAGM	0.044	NO	BSL
959-98-8	Endosulfan I	0.0041	J	0.016	J	SB59-2	2 / 199	0.9	0.002	110	0.22	0.016		370	900	NYSDEC TAGM	0.9	NO	BSL
33213-65-9	Endosulfan II	0.0071	J	0.0071	J	TP59-2	1 / 199	1.7	0.003	215	0.43	0.0071		370	900	NYSDEC TAGM	0.9	NO	BSL
1031-07-8	Endosulfan sulfate	0.0043	J	0.0062	J	CL-59-OTHERC-WE2	2 / 199	1.7	0.003	215	0.43	0.0062		370	1000	NYSDEC TAGM	1	NO	BSL
72-20-8	Endrin	0.0038	NJ	0.016	NJ	CL-59-04-FO1	4 / 199	1.7	0.003	215	0.43	0.016		18	100	NYSDEC TAGM	0.1	NO	BSL
7421-93-4	Endrin aldehyde	0.0035	J	0.0063	J	TP59-2	5 / 199	1.7	0.003	215	0.43	0.0063		18			NO	BSL	
53494-70-5	Endrin ketone	0.0033	J	0.038	J	WS-59-01-011-3	5 / 199	1.7	0.003	215	0.43	0.038		18			NO	BSL	
5103-74-2	Gamma-Chlordane	0.001	J	0.024	J	WS-59-04-010-10	16 / 199	0.9	0.002	110	0.22	0.024		1.6	540	NYSDEC TAGM	0.54	NO	BSL
1024-57-3	Heptachlor epoxide	0.001	J	0.0057	J	TP59-6-2	5 / 199	0.9	0.002	110	0.22	0.0057		0.053	20	NYSDEC TAGM	0.02	NO	BSL
Metals																			
7429-90-5	Aluminum	4,200		18,300	J	CL-59-01-F12	## / 199	0				18,300	20,500	76,000	19300	NYSDEC TAGM	19,300	NO	BSL
7440-36-0	Antimony	0.24	J	424	J	SB59-4	## / 199	0.07	0.14	3.615	3.62	424	6.55	31	5.9	NYSDEC TAGM	5.9	YES	ASL
7440-38-2	Arsenic	2.3	J	32.2	J	CL-59-01-WN2	## / 199	0				32.2	21.5	0.39	8.2	NYSDEC TAGM	8.2	YES	ASL

**TABLE 6-2A
OCCURRENCE, DISTRIBUTION AND SELECTION OF CHEMICALS OF POTENTIAL CONCERN IN SEAD-59 SITE SOIL
SEAD-59 AND SEAD-71 PHASE II RI**

Seneca Army Depot Activity

Scenario Time frame:	Cuurent/Future
Medium:	Soil
Exposure Medium:	Soil
Exposure Point:	SEAD-59

CAS Number	Chemical	Minimum Detected Concentration ¹ (mg/kg)	Q	Maximum Detected Concentration ¹ (mg/kg)	Q	Location of Maximum Concentration	Detection Frequency ¹	Range of Reporting Limits ¹ (mg/kg)			Concentration Used for Screening ² (mg/kg)	Background Value ³ (mg/kg)	Screening Value ⁴ (mg/kg)	Potential ARAR/TBC Value	Potential ARAR/TBC Source	Potential ARAR/TBC Value ⁵ (mg/kg)	COPC Flag	Rationale for Contaminant Deletion or Selection ⁶	
7440-39-3	Barium	21.1	J	304		SB59-4	## / 199				304	159	5,400	300	NYSDEC TAGM	300	NO	BSL	
7440-41-7	Beryllium	0.11	J	2.6		CL-59-01-WN2	## / 199	0.025	0.05 -	0.045	0.045	2.6	1.4	150	1.1	NYSDEC TAGM	1.1	NO	BSL
7440-43-9	Cadmium	0.1	J	3.2		SB59-4	## / 199	0.035	0.07 -	0.15	0.15	3.2	2.9	37	2.3	NYSDEC TAGM	2.3	NO	BSL
7440-70-2	Calcium	1,350	J	214,000		SB59-4	## / 199	0			214,000	293,000	2,500,000	121,000	NYSDEC TAGM	121,000	NO	NUT	
7440-47-3	Chromium	7.4	J	39.3	J	CL-59-01-WN2	## / 199	0			39.3	32.7	210	29.6	NYSDEC TAGM	29.6	NO	BSL	
7440-48-4	Cobalt	3.8	J	47.8		CL-59-01-WN2	## / 199	0			47.8	29.1	900	30	NYSDEC TAGM	30	NO	BSL	
7440-50-8	Copper	9.8	J	305		WS-59-01-013-5	## / 199	0			305	62.8	3,100	33	NYSDEC TAGM	33	NO	BSL	
7439-89-6	Iron	6,540	J	64,000	J	CL-59-01-WN2	## / 199	0			64,000	38,600	23,000	36,500	NYSDEC TAGM	36,500	YES	ASL	
7439-92-1	Lead	4.1	J	164		WS-59-01-006-8	## / 199	0			164	266	400	24.8	NYSDEC TAGM	24.8	NO	BSL	
7439-95-4	Magnesium	2,530	J	34,400		SB59-5	## / 199	0			34,400	29,100	400,000	21,500	NYSDEC TAGM	21,500	NO	NUT	
7439-96-5	Manganese	156	J	1290	J	CL-59-01-WS6	## / 199	0			1290	2380	1,800	1060	NYSDEC TAGM	1,060	NO	BSL	
7439-97-6	Mercury	0.02	J	0.95	J	WS-59-04-010-6	## / 198	0.01	0.02 -	0.03	0.03	0.95	0.13	23	0.1	NYSDEC TAGM	0.1	NO	BSL
7440-02-0	Nickel	9	J	88.3	J	CL-59-01-WN2	## / 199	0			88.3	62.3	1,600	49	NYSDEC TAGM	49	NO	BSL	
7440-09-7	Potassium	539	J	2,520	J	SB59-1	## / 199	0			2,520	3,160	5,000,000	2380	NYSDEC TAGM	2,380	NO	NUT	
7782-49-2	Selenium	0.28	J	1.5		SB59-21	21 / 199	0.06	0.12 -	0.575	0.58	1.5	1.7	390	2	NYSDEC TAGM	2	NO	BSL
7440-22-4	Silver	0.11	J	2.9		CL-59-OTHERA-WN1	88 / 199	0.04	0.08 -	0.305	0.31	2.9	0.87	390	0.75	NYSDEC TAGM	0.75	NO	BSL
7440-23-5	Sodium	33.3	J	4,060	J	CL-59-01-WE5	## / 199	41.55	83.1 -	57.5	57.5	4,060	269	1,125,000	172	NYSDEC TAGM	172	NO	NUT
7440-28-0	Thallium	0.11	J	1.8	J	CL-59-03-WS3	51 / 199	0.09	0.18 -	0.75	0.75	1.8	1.2	5.2	0.7	NYSDEC TAGM	0.7	NO	BSL
7440-62-2	Vanadium	8.4	J	28.5	J	CL-59-01-F12	## / 199	0			28.5	32.7	78	150	NYSDEC TAGM	150	NO	BSL	
7440-66-6	Zinc	19.6	J	341		SB59-4	## / 199	0			341	126	23,000	110	NYSDEC TAGM	110	NO	BSL	

Notes:

- Field duplicates were treated as discrete samples. Lab duplicates were not included in the assessment. Range of reporting limits were presented for nondetects only.
- The maximum detected concentration was used for screening.
- Background value is the maximum Seneca background concentrations.
- EPA Region 9 Preliminary Remediation Goals (PRGs) for residential soil. On-line resources available at <http://www.epa.gov/region09/waste/sfund/prg/files/prgtable2004.xls>. Last updated October 2004. Target Cancer Risk = 1E-6; Target Hazard Quotient =1. Direct contact exposure (ingestion and dermal contact) is evaluated to derive the PRGs. PRG for xylenes was used as screening value for meta/para xylenes and ortho xylene. EPA Region III Risk Based Concentration (RBC) for residential soil was used as screening value for 2-methylnaphthalene as no Region 9 PRG is available. EPA Region III RBC, available on-line at <http://www.epa.gov/reg3hwmd/risk/human/rbc/rbc1004.XLS>, was calculated based on soil ingestion exposure and a target cancer risk of 1E-6 and a target hazard quotient of 1.

**TABLE 6-2A
OCCURRENCE, DISTRIBUTION AND SELECTION OF CHEMICALS OF POTENTIAL CONCERN IN SEAD-59 SITE SOIL
SEAD-59 AND SEAD-71 PHASE II RI
Seneca Army Depot Activity**

Scenario Time frame:	Current/Future
Medium:	Soil
Exposure Medium:	Soil
Exposure Point:	SEAD-59

CAS Number	Chemical	Minimum Detected Concentration ¹ (mg/kg)	Q	Maximum Detected Concentration ¹ (mg/kg)	Q	Location of Maximum Concentration	Detection Frequency ¹	Range of Reporting Limits ¹ (mg/kg)	Concentration Used for Screening ² (mg/kg)	Background Value ³ (mg/kg)	Screening Value ⁴ (mg/kg)	Potential ARAR/TBC Value	Potential ARAR/TBC Source	Potential ARAR / TBC Value ⁵ (mg/kg)	COPC Flag	Rationale for Contaminant Deletion or Selection ⁶
------------	----------	--	---	--	---	-----------------------------------	----------------------------------	---	--	--	---	--------------------------	---------------------------	--	-----------	--

PRG for Aroclor 1254 was used as screening value for Aroclor 1260.
 PRG for gamma-chlordane was used as screening value for alpha-chlordane.
 PRG for alpha-BHC was used as screening value for delta-BHC.
 PRG for endosulfan was used as screening value for endosulfan I, endosulfan II, and endosulfan sulfate.
 PRG for endrin was used as screening value for endrin aldehyde and endrin ketone.
 Screening values for calcium, magnesium, potassium, and sodium were calculated based on an assumption of 200 mg/day soil ingestion and recommended dietary allowances and adequate intakes for 1-3 yr children (500 mg/day and 80 mg/day for calcium and magnesium) and minimum requirements for 1 yr children (225 mg/day and 1000 mg/day for sodium and potassium) from Marilyn Wright (2001) Dietary Reference Intakes.
 PRG for total chromium (1:6 ratio Cr VI: Cr III) was used as screening value for chromium.
 PRG for nickel (soluble salts) was used as screening value for nickel.

5. Potential ARAR/TBC values are from NYSDEC Technical and Administrative Guidance Memorandum #4046 (on-line resources available at <http://www.dec.state.ny.us/website/der/tagms/prtg4046.html>)

6. Rationale codes

Selection Reason:	Above Screening Levels (ASL)
	Chemicals in the Same Group were retained as COPC (CSG)
Deletion Reason:	Essential Nutrient (NUT)
	Below Screening Level (BSL)
	No Screening Value or Toxicity Value (NSV)
	Individual Chemicals Evaluated (ICE)

Definitions:

COPC = Chemical of Potential Concern
 ARAR/TBC = Applicable or Relevant and Appropriate Requirement/To Be Considered
 Q = Qualifier
 J = Estimated Value
 NJ = Presence of the analyte has been "tentatively identified" and the associated numerical value represents its approximate concentration.

TABLE 6-2B
OCCURRENCE, DISTRIBUTION AND SELECTION OF CHEMICALS OF POTENTIAL CONCERN IN SEAD-71 SOIL
SEAD-59 AND SEAD-71 PHASE II RI
Seneca Army Depot Activity

Scenario Time frame:	Current/Future
Medium:	Soil
Exposure Medium:	Soil
Exposure Point:	SEAD-71

CAS Number	Chemical	Minimum Detected Concentration ¹ (mg/kg)	Q	Maximum Detected Concentration ¹ (mg/kg)	Q	Location of Maximum Concentration	Detection Frequency ¹	Range of Reporting Limits ¹ (mg/kg)	Concentration Used for Screening ² (mg/kg)	Background Value ³ (mg/kg)	Screening Value ⁴ (mg/kg)	Potential ARAR/TBC Value ⁵ (mg/kg)	COPC Flag	Rationale for Contaminant Deletion or Selection ⁶
VOC														
71-55-6	1,1,1-Trichloroethane	0.002	NJ	0.023		TP71-1	7 / 76	0.005 - 0.11	0.023		1,200	0.8	NO	BSL
67-64-1	Acetone	0.004	NJ	0.074		SS71-14	9 / 76	0.005 - 0.11	0.074		14,000	0.2	NO	BSL
71-43-2	Benzene	0.001	J	0.002	J	SS71-1	2 / 76	0.005 - 0.11	0.002		0.64	0.06	NO	BSL
75-15-0	Carbon disulfide	0.002	J	0.005	J	CL-71-B-WN1	3 / 76	0.005 - 0.11	0.005		360	2.7	NO	BSL
110-82-7	Cyclohexane	0.003	J	0.004	J	WS-71-A-009-9	2 / 23	0.005 - 0.006	0.004		140		NO	BSL
100-41-4	Ethyl benzene	0.004	J	0.004	J	SS71-13	2 / 76	0.005 - 0.11	0.004		400	5.5	NO	BSL
108-87-2	Methyl cyclohexane	0.003	J	0.006		WS-71-A-009-9	3 / 23	0.005 - 0.006	0.006		2,600		NO	BSL
75-09-2	Methylene chloride	0.001	J	0.011	J	TP71-2	12 / 76	0.005 - 0.11	0.011		9.1	0.1	NO	BSL
100-42-5	Styrene	0.001	J	0.001	J	SS71-20	1 / 55	0.005 - 0.11	0.001		1,700		NO	BSL
127-18-4	Tetrachloroethene	0.001	J	0.033		SS71-16	4 / 76	0.005 - 0.11	0.033		0.48	1.4	NO	BSL
108-88-3	Toluene	0.001	J	0.016		SS71-17	11 / 76	0.005 - 0.11	0.016		520	1.5	NO	BSL
	Total BTEX	3.05		11.6		TP71-3-1	4 / 4		11.6				NO	ICE
1330-20-7	Total Xylenes	0.002	J	0.096	J	TP71-3-2	6 / 52	0.005 - 0.015	0.096		270	1.2	NO	BSL
75-69-4	Trichlorofluoromethane	0.001	J	0.001	J	WS-71-B-009-6	1 / 23	0.005 - 0.006	0.001		390		NO	BSL
121-14-2	2,4-Dinitrotoluene	0.88	J	0.88	J	WS-71-D-009-13	1 / 77	0.066 - 72	0.88		120		NO	BSL
SVOC														
91-57-6	2-Methylnaphthalene	0.0086	J	31	J	TP71-3-2	17 / 77	0.078 - 39	31		310	36.4	NO	BSL
100-01-6	4-Nitroaniline	0.075	J	0.075	J	WS-71-B-009-6	1 / 55	0.16 - 180	0.075		23		NO	BSL
83-32-9	Acenaphthene	0.0055	J	42	J	SS71-13	34 / 77	0.078 - 5.5	42		3,700	50	NO	BSL
208-96-8	Acenaphthylene	0.02	J	1.8		CL-71-C-WN1	20 / 77	0.066 - 72	1.8			41	NO	NSV
120-12-7	Anthracene	0.012	J	100		SS71-11	46 / 77	0.078 - 5.5	100		22,000	50	NO	BSL
56-55-3	Benzo(a)anthracene	0.0039	J	150		SS71-11	60 / 77	0.078 - 1.9	150		0.62	0.224	YES	ASL
50-32-8	Benzo(a)pyrene	0.0039	J	120		SS71-11	60 / 77	0.066 - 1.9	120		0.062	0.061	YES	ASL
205-99-2	Benzo(b)fluoranthene	0.0044	J	88		SS71-11	61 / 77	0.066 - 1.9	88		0.62	1.1	YES	ASL
191-24-2	Benzo(ghi)perylene	0.012	J	62	J	SS71-11	54 / 77	0.066 - 1.9	62			50	NO	NSV
207-08-9	Benzo(k)fluoranthene	0.0046	J	130		SS71-11	49 / 77	0.066 - 1.9	130		6.2	1.1	YES	ASL

TABLE 6-2B
OCCURRENCE, DISTRIBUTION AND SELECTION OF CHEMICALS OF POTENTIAL CONCERN IN SEAD-71 SOIL
SEAD-59 AND SEAD-71 PHASE II RI
Seneca Army Depot Activity

Scenario Time frame:	Current/Future
Medium:	Soil
Exposure Medium:	Soil
Exposure Point:	SEAD-71

CAS Number	Chemical	Minimum Detected Concentration ¹ (mg/kg)	Q	Maximum Detected Concentration ¹ (mg/kg)	Q	Location of Maximum Concentration	Detection Frequency ¹	Range of Reporting Limits ¹ (mg/kg)	Concentration Used for Screening ² (mg/kg)	Background Value ³ (mg/kg)	Screening Value ⁴ (mg/kg)	Potential ARAR/TBC Value ⁵ (mg/kg)	COPC Flag	Rationale for Contaminant Deletion or Selection ⁶
117-81-7	Bis(2-Ethylhexyl)phthalate	0.0076	J	0.14	J	WS-71-D-009-13	9 / 77	0.066 - 72	0.14		35	50	NO	BSL
86-74-8	Carbazole	0.0042	J	77		SS71-13	33 / 55	0.078 - 1.5	77		24		YES	ASL
218-01-9	Chrysene	0.0046	J	150		SS71-11	63 / 77	0.078 - 1.9	150		62	0.4	YES	ASL
84-74-2	Di-n-butylphthalate	0.0064	J	0.14	J	SS71-19	4 / 77	0.066 - 72	0.14		6,100	8.1	NO	BSL
53-70-3	Dibenz(a,h)anthracene	0.0044	J	25	J	SS71-11	45 / 77	0.066 - 5.5	25		0.062	0.014	YES	ASL
132-64-9	Dibenzofuran	0.013	J	38	J	SS71-13	29 / 77	0.078 - 19	38		150	6.2	NO	BSL
206-44-0	Fluoranthene	0.0069	J	440		SS71-11	65 / 77	0.078 - 0.4	440		2,300	50	NO	BSL
86-73-7	Fluorene	0.0047	J	62	J	SS71-13	32 / 77	0.078 - 5.5	62		2,700	50	NO	BSL
193-39-5	Indeno(1,2,3-cd)pyrene	0.012	J	65	J	SS71-11	54 / 77	0.066 - 1.9	65		0.62	3.2	YES	ASL
91-20-3	Naphthalene	0.01	J	46	J	SS71-13	18 / 77	0.078 - 39	46		56	13	NO	BSL
85-01-8	Phenanthrene	0.024	J	290		SS71-13	60 / 77	0.078 - 1.9	290			50	NO	NSV
108-95-2	Phenol	0.0045	J	0.0045	J	TP71-3-1	1 / 77	0.078 - 72	0.0045		18,000	0.03	NO	BSL
129-00-0	Pyrene	0.006	J	280		SS71-11	63 / 77	0.078 - 1.9	280		2,300	50	NO	BSL
Pesticide														
72-54-8	4,4'-DDD	0.0028	J	0.24		SS71-17	18 / 77	0.0035 - 0.04	0.24		2.4	2.9	NO	BSL
72-55-9	4,4'-DDE	0.0031	J	0.81		SS71-17	31 / 77	0.0034 - 0.038	0.81		1.7	2.1	NO	BSL
50-29-3	4,4'-DDT	0.0027	J	1.3		SS71-16	38 / 77	0.0034 - 0.038	1.3		1.7	2.1	NO	BSL
319-84-6	Alpha-BHC	0.0012	J	0.018		TP71-6-1	8 / 77	0.0018 - 0.022	0.018		0.09	0.11	NO	BSL
5103-71-9	Alpha-Chlordane	0.002	J	0.074	J	TP71-1	2 / 77	0.0018 - 0.022	0.074		1.6		NO	BSL
319-85-7	Beta-BHC	0.0019		0.035		SS71-17	8 / 77	0.0018 - 0.022	0.035		0.32	0.2	NO	BSL
319-86-8	Delta-BHC	0.0018	J	0.0018	J	TP71-6-1	1 / 77	0.0018 - 0.022	0.0018		0.09	0.3	NO	BSL
60-57-1	Dieldrin	0.003	J	0.0035	J	TP71-1	3 / 77	0.0034 - 0.042	0.0035		0.03	0.044	NO	BSL
959-98-8	Endosulfan I	0.0015	J	0.2	J	TP71-1	11 / 77	0.0018 - 0.022	0.2		370	0.9	NO	BSL
33213-65-9	Endosulfan II	0.002	J	0.052		SS71-15	5 / 77	0.0034 - 0.042	0.052		370	0.9	NO	BSL
1031-07-8	Endosulfan sulfate	0.0022	J	0.11		SS71-13	11 / 77	0.0034 - 0.04	0.11		370	1	NO	BSL
72-20-8	Endrin	0.0024	J	0.12		SS71-16	12 / 77	0.0034 - 0.042	0.12		18	0.1	NO	BSL
7421-93-4	Endrin aldehyde	0.003	J	0.12		SS71-6	18 / 77	0.0034 - 0.04	0.12		18		NO	BSL

**TABLE 6-2B
OCCURRENCE, DISTRIBUTION AND SELECTION OF CHEMICALS OF POTENTIAL CONCERN IN SEAD-71 SOIL
SEAD-59 AND SEAD-71 PHASE II RI
Seneca Army Depot Activity**

Scenario Time frame:	Current/Future
Medium:	Soil
Exposure Medium:	Soil
Exposure Point:	SEAD-71

CAS Number	Chemical	Minimum Detected Concentration ¹ (mg/kg)	Q	Maximum Detected Concentration ¹ (mg/kg)	Q	Location of Maximum Concentration	Detection Frequency ¹	Range of Reporting Limits ¹ (mg/kg)	Concentration Used for Screening ² (mg/kg)	Background Value ³ (mg/kg)	Screening Value ⁴ (mg/kg)	Potential ARAR/TBC Value ⁵ (mg/kg)	COPC Flag	Rationale for Contaminant Deletion or Selection ⁶
53494-70-5	Endrin ketone	0.0022	J	0.18		SS71-17	16 / 77	0.0034 - 0.04	0.18		18		NO	BSL
58-89-9	Gamma-BHC/Lindane	0.004		0.004		TP71-6-1	1 / 77	0.0018 - 0.022	0.004		0.44	0.06	NO	BSL
5103-74-2	Gamma-Chlordane	0.0011	J	0.048		SS71-17	5 / 77	0.0018 - 0.022	0.048		1.6	0.54	NO	BSL
76-44-8	Heptachlor	0.0012	J	0.0012	J	TP71-1	1 / 77	0.0018 - 0.022	0.0012		0.11	0.1	NO	BSL
1024-57-3	Heptachlor epoxide	0.0015	J	0.18		SS71-17	13 / 77	0.0018 - 0.021	0.18		0.053	0.02	YES	ASL
72-43-5	Methoxychlor	0.011	J	0.52		SS71-5	12 / 77	0.018 - 0.22	0.52		310		NO	BSL
PCB														
11096-82-5	Aroclor-1260	0.08		0.2	J	CL-71-B-WE2	3 / 77	0.035 - 0.42	0.2		0.22	10	NO	BSL
Metals														
7429-90-5	Aluminum	1,710		18,000		TP71-2	77 / 77		18,000	20,500	76,000	19,300	NO	BSL
7440-36-0	Antimony	0.19	J	19.3	J	SS71-16	36 / 77	0.18 - 3.6	19.3	6.55	31	5.9	NO	BSL
7440-38-2	Arsenic	2.1		14.6		SS71-9	77 / 77		14.6	21.5	0.39	8.2	YES	ASL
7440-39-3	Barium	20.9	J	179	J	SS71-16	77 / 77		179	159	5,400	300	NO	BSL
7440-41-7	Beryllium	0.05		0.88	J	TP71-2	76 / 77	0.02 - 0.02	0.88	1.4	150	1.1	NO	BSL
7440-43-9	Cadmium	0.17	J	12.1	J	SS71-15	50 / 77	0.05 - 1.1	12.1	2.9	37	2.3	NO	BSL
7440-70-2	Calcium	4,260	J	295,000		SS71-14	77 / 77		295,000	293,000	2,500,000	121,000	NO	NUT
7440-47-3	Chromium	4.2	J	60.3	J	SS71-19	77 / 77		60.3	32.7	210	29.6	NO	BSL
7440-48-4	Cobalt	3.3		14.6		TP71-2	77 / 77		14.6	29.1	900	30	NO	BSL
7440-50-8	Copper	5.4	J	134	J	SS71-16	77 / 77		134	62.8	3,100	33	NO	BSL
7439-89-6	Iron	5,990		65,100		SS71-5	77 / 77		65,100	38,600	23,000	36,500	YES	ASL
7439-92-1	Lead	7.3		3,470	J	SS71-16	77 / 77		3,470	266	400	24.8	YES	ASL
7439-95-4	Magnesium	3,800		59,300		SS71-14	77 / 77		59,300	29,100	400,000	21,500	NO	NUT
7439-96-5	Manganese	202	J	1,330		CL-71-E3-WS1	77 / 77		1,330	2380	1,800	1,060	NO	BSL
7439-97-6	Mercury	0.02	J	2.7	J	SS71-16	59 / 77	0.05 - 0.07	2.7	0.13	23	0.1	NO	BSL
7440-02-0	Nickel	8.7		110		SS71-10	77 / 77		110	62.3	1,600	49	NO	BSL
7440-09-7	Potassium	671		2,940		TP71-4-2	77 / 77		2,940	3,160	5,000,000	2,380	NO	NUT
7782-49-2	Selenium	0.43	J	1.8	J	SS71-10	15 / 77	0.37 - 1.1	1.8	1.7	390	2	NO	BSL

TABLE 6-2B
OCCURRENCE, DISTRIBUTION AND SELECTION OF CHEMICALS OF POTENTIAL CONCERN IN SEAD-71 SOIL
SEAD-59 AND SEAD-71 PHASE II RI
Seneca Army Depot Activity

Scenario Time frame:	Current/Future
Medium:	Soil
Exposure Medium:	Soil
Exposure Point:	SEAD-71

CAS Number	Chemical	Minimum Detected Concentration ¹ (mg/kg)	Q	Maximum Detected Concentration ¹ (mg/kg)	Q	Location of Maximum Concentration	Detection Frequency ¹	Range of Reporting Limits ¹ (mg/kg)	Concentration Used for Screening ² (mg/kg)	Background Value ³ (mg/kg)	Screening Value ⁴ (mg/kg)	Potential ARAR/TBC Value ⁵ (mg/kg)	COPC Flag	Rationale for Contaminant Deletion or Selection ⁶
7440-22-4	Silver	0.32	J	2.2	J	SS71-11	27 / 77	0.06 - 0.67	2.2	0.87	390	0.75	NO	BSL
7440-23-5	Sodium	33.2	J	1,040		SS71-5	73 / 77	17.6 - 108	1,040	269	1,125,000	172	NO	NUT
7440-28-0	Thallium	0.57	J	2.3		SS71-9	18 / 77	0.19 - 1.7	2.3	1.2	5.2	0.7	NO	BSL
7440-62-2	Vanadium	6.9		29.2		TP71-2	77 / 77		29.2	32.7	78	150	NO	BSL
7440-66-6	Zinc	43.4	J	3,660	J	SS71-5	76 / 77	352 - 352	3,660	126	23,000	110	NO	BSL

Notes:

- Field duplicates were averaged and regarded as one sample entry. Lab duplicates were not included in the assessment.
Range of reporting limits were presented for nondetects only.
- The maximum detected concentration was used for screening.
- Background value is the maximum Seneca background concentrations.
- EPA Region 9 Preliminary Remediation Goals (PRGs) for residential soil. On-line resources available at <http://www.epa.gov/region09/waste/sfund/prg/files/prgtable2004.xls>. Last updated October 2004.
Target Cancer Risk = 1E-6; Target Hazard Quotient =1. Direct contact exposure (ingestion and dermal contact) is evaluated to derive the PRGs.
EPA Region III Risk Based Concentration (RBC) for residential soil was used as screening value for 2-methylnaphthalene as no Region 9 PRG is available. EPA Region III RBC, available on-line at <http://www.epa.gov/reg3hwmd/risk/human/rbc/rbc1004.XLS>, was calculated based on soil ingestion exposure and a target cancer risk of 1E-6 and a target hazard quotient of 1.
PRG for Aroclor 1254 was used as screening value for Aroclor 1260.
PRG for gamma-chlordane was used as screening value for alpha-chlordane.
PRG for alpha-BHC was used as screening value for delta-BHC.
PRG for endosulfan was used as screening value for endosulfan I, endosulfan II, and endosulfan sulfate.
PRG for endrin was used as screening value for endrin aldehyde and endrin ketone.
Screening values for calcium, magnesium, potassium, and sodium were calculated based on an assumption of 200 mg/day soil ingestion and recommended dietary allowances and adequate intakes for 1-3 yr children (500 mg/day and 80 mg/day for calcium and magnesium) and minimum requirements for 1 yr children (225 mg/day and 1000 mg/day for sodium and potassium) from Marilyn Wright (2001) Dietary Reference Intakes.
PRG for total chromium (1:6 ratio Cr VI: Cr III) was used as screening value for chromium.
PRG for nickel (soluble salts) was used as screening value for nickel.

TABLE 6-2B
OCCURRENCE, DISTRIBUTION AND SELECTION OF CHEMICALS OF POTENTIAL CONCERN IN SEAD-71 SOIL
SEAD-59 AND SEAD-71 PHASE II RI
Seneca Army Depot Activity

Scenario Time frame:	Current/Future
Medium:	Soil
Exposure Medium:	Soil
Exposure Point:	SEAD-71

CAS Number	Chemical	Minimum Detected Concentration ¹ (mg/kg)	Q	Maximum Detected Concentration ¹ (mg/kg)	Q	Location of Maximum Concentration	Detection Frequency ¹	Range of Reporting Limits ¹ (mg/kg)	Concentration Used for Screening ² (mg/kg)	Background Value ³ (mg/kg)	Screening Value ⁴ (mg/kg)	Potential ARAR/TBC Value ⁵ (mg/kg)	COPC Flag	Rationale for Contaminant Deletion or Selection ⁶
------------	----------	--	---	--	---	-----------------------------------	----------------------------------	---	--	--	---	--	-----------	--

5. Potential ARAR/TBC values are from NYSDEC Technical and Administrative Guidance Memorandum #4046
(on-line resources available at <http://www.dec.state.ny.us/website/der/tagms/prtg4046.html>)

6. Rationale codes
Selection Reason: Above Screening Levels (ASL)
Deletion Reason: Essential Nutrient (NUT)
Below Screening Level (BSL)
Individual Chemicals Evaluated (ICE)
No Screening Value or Toxicity Value (NSV)

Definitions:
COPC = Chemical of Potential Concern
ARAR/TBC = Applicable or Relevant and Appropriate Requirement/To Be Considered
Q = Qualifier
J = Estimated Value
NJ = Presence of the analyte has been "tentatively identified" and the associated numerical value represents its approximate concentration.

**TABLE 6-2C
OCCURRENCE, DISTRIBUTION AND SELECTION OF CHEMICALS OF POTENTIAL CONCERN IN SEAD-59 STOCKPILE SOIL
SEAD-59 AND SEAD-71 PHASE II RI
Seneca Army Depot Activity**

Scenario Time frame:	Current/Future
Medium:	Soil
Exposure Medium:	Soil
Exposure Point:	SEAD-59 Stockpile

CAS Number	Chemical	Minimum Detected Concentration ¹ (mg/kg)	Q	Maximum Detected Concentration ¹ (mg/kg)	Q	Location of Maximum Concentration	Detection Frequency ¹	Range of Reporting Limits ¹ (mg/kg)	Concentration Used for Screening ² (mg/kg)	Background Value ³ (mg/kg)	Screening Value ⁴ (mg/kg)	Potential ARAR /TBC Value ⁵ (mg/kg)	COPC Flag	Rationale for Contaminant Deletion or Selection ⁶
VOC														
76-13-1	1,1,2-Trichloro-1,2,2-Trifluoroethane	0.0015	J	0.0015	J	WS-59-01-016-13	1 / 53	0.005 - 0.006	0.0015		5,600		NO	BSL
75-35-4	1,1-Dichloroethene	0.001	J	0.001	J	WS-59-01-011-1	1 / 53	0.005 - 0.006	0.001		120	0.4	NO	BSL
67-64-1	Acetone	0.0048	J	0.069	NJ	WS-59-01-012-2	13 / 53	0.005 - 0.025	0.069		14,000	0.2	NO	BSL
	Meta/Para Xylene	0.0022	J	0.0023	J	WS-59-01-007-13	2 / 48	0.0055 - 0.006	0.0023		270		NO	BSL
78-93-3	Methyl ethyl ketone	0.0026	J	0.007	J	WS-59-01-012-2	5 / 53	0.005 - 0.012	0.007		22,000		NO	BSL
75-09-2	Methylene chloride	0.0021	J	0.0021	J	FD-59-WS-03/WS-59-01-006-12	1 / 53	0.005 - 0.006	0.0021		9.1	0.1	NO	BSL
95-47-6	Ortho Xylene	0.001	J	0.0019	J	WS-59-01-016-10	5 / 48	0.0055 - 0.006	0.0019		270		NO	BSL
127-18-4	Tetrachloroethene	0.0053	J	0.0067		WS-59-01-016-20	3 / 53	0.005 - 0.006	0.0067		0.48	1.4	NO	BSL
1330-20-7	Total Xylenes	0.003	J	0.003	J	WS-59-01-011-1	1 / 5	0.005 - 0.006	0.003		270		NO	BSL
79-01-6	Trichloroethene	0.0011	J	0.0028	J	FD-59-WS-03/WS-59-01-006-12	4 / 53	0.005 - 0.006	0.0028		0.053	0.7	NO	BSL
SVOC														
92-52-4	1,1'-Biphenyl	0.059	J	0.059	J	WS-59-01-012-2	1 / 5	0.37 - 1.9	0.059		3,000		NO	BSL
91-57-6	2-Methylnaphthalene	0.039	J	1.2	J	WS-59-01-007-1	27 / 53	0.37 - 3.8	1.2		310		NO	BSL
83-32-9	Acenaphthene	0.046	J	2.4		WS-59-01-016-9	46 / 53	0.37 - 1.9	2.4		3,700	50	NO	BSL
208-96-8	Acenaphthylene	0.097	J	3.5	J	WS-59-01-007-14	52 / 53	0.37 - 0.37	3.5			41	NO	NSV
120-12-7	Anthracene	0.11	J	6.6		WS-59-01-007-14	53 / 53		6.6		22,000	50	NO	BSL
56-55-3	Benzo(a)anthracene	0.086	NJ	14		WS-59-01-011-7	53 / 53		14		0.62	0.224	YES	ASL
50-32-8	Benzo(a)pyrene	0.085	J	16		WS-59-01-011-7	53 / 53		16		0.062	0.061	YES	ASL
205-99-2	Benzo(b)fluoranthene	0.11	J	11		WS-59-01-011-7	53 / 53		11		0.62	1.1	YES	ASL
191-24-2	Benzo(ghi)perylene	0.052	J	8		WS-59-01-011-7	53 / 53		8			50	NO	NSV
207-08-9	Benzo(k)fluoranthene	0.048	J	13		WS-59-01-011-7	53 / 53		13		6.2	1.1	YES	ASL
117-81-7	Bis(2-Ethylhexyl)phthalate	0.097	J	0.13	NJ	WS-59-01-012-2	3 / 53	0.38 - 3.8	0.13		35	50	NO	BSL
86-74-8	Carbazole	0.042	J	1.1	J	WS-59-01-011-1	4 / 5	0.37 - 0.37	1.1		24		NO	BSL
218-01-9	Chrysene	0.087	J	13		WS-59-01-007-14	53 / 53		13		62	0.4	YES	CSG
53-70-3	Dibenz(a,h)anthracene	0.073	J	2.9	J	WS-59-01-012-3	52 / 53	0.37 - 0.37	2.9		0.062	0.014	YES	ASL
132-64-9	Dibenzofuran	0.19	J	1.3	J	WS-59-01-016-9	33 / 53	0.37 - 3.8	1.3		150	6.2	NO	BSL
206-44-0	Fluoranthene	0.17	J	29		WS-59-01-007-14	53 / 53		29		2,300	50	NO	BSL
86-73-7	Fluorene	0.051	NJ	3.1		WS-59-01-016-9	47 / 53	0.37 - 1.9	3.1		2,700	50	NO	BSL
193-39-5	Indeno(1,2,3-cd)pyrene	0.055	J	8	J	WS-59-01-011-7	53 / 53		8		0.62	3.2	YES	ASL
91-20-3	Naphthalene	0.046	J	1.2	J	WS-59-01-007-13	33 / 53	0.37 - 3.8	1.2		56	13	NO	BSL

TABLE 6-2C
OCCURRENCE, DISTRIBUTION AND SELECTION OF CHEMICALS OF POTENTIAL CONCERN IN SEAD-59 STOCKPILE SOIL
SEAD-59 AND SEAD-71 PHASE II RI
Seneca Army Depot Activity

Scenario Time frame:	Current/Future
Medium:	Soil
Exposure Medium:	Soil
Exposure Point:	SEAD-59 Stockpile

CAS Number	Chemical	Minimum Detected Concentration ¹ (mg/kg)	Q	Maximum Detected Concentration ¹ (mg/kg)	Q	Location of Maximum Concentration	Detection Frequency ¹	Range of Reporting Limits ¹ (mg/kg)	Concentration Used for Screening ² (mg/kg)	Background Value ³ (mg/kg)	Screening Value ⁴ (mg/kg)	Potential ARAR /TBC Value ⁵ (mg/kg)	COPC Flag	Rationale for Contaminant Deletion or Selection ⁶	
87-86-5	Pentachlorophenol	0.66	J	0.66	J	WS-59-01-014-5	1 / 53	0.93 - 20	0.66		3.0	1	NO	BSL	
85-01-8	Phenanthrene	0.12	J	17		WS-59-01-007-14	53 / 53		17			50	NO	NSV	
129-00-0	Pyrene	0.16	J	22		WS-59-01-012-3	53 / 53		22		2,300	50	NO	BSL	
Pesticide															
72-54-8	4,4'-DDD	0.006		0.45		WS-59-01-015-14	33 / 53	0.019 - 0.098	0.45		2.4	2.9	NO	BSL	
72-55-9	4,4'-DDE	0.0024	J	0.23		WS-59-01-006-9	33 / 53	0.018 - 0.098	0.23		1.7	2.1	NO	BSL	
50-29-3	4,4'-DDT	0.0061	J	0.52		WS-59-01-015-14	37 / 53	0.019 - 0.098	0.52		1.7	2.1	NO	BSL	
319-84-6	Alpha-BHC	0.0044		0.0044		WS-59-01-011-2	1 / 53	0.0019 - 0.051	0.0044		0.09	0.11	NO	BSL	
5103-71-9	Alpha-Chlordane	0.0034		0.027	J	WS-59-01-011-8	6 / 53	0.002 - 0.051	0.027		1.6		NO	BSL	
319-85-7	Beta-BHC	0.013	NJ	0.013	NJ	WS-59-01-014-5	1 / 53	0.0019 - 0.051	0.013		0.32	0.2	NO	BSL	
53494-70-5	Endrin ketone	0.015	J	0.015	J	WS-59-01-011-2	1 / 53	0.0037 - 0.098	0.015		18		NO	BSL	
58-89-9	Gamma-Chlordane	0.0079		0.021	J	WS-59-01-005-5	5 / 53	0.0019 - 0.051	0.021		1.6	0.54	NO	BSL	
Metals															
7429-90-5	Aluminum	6,830	J	13,400		WS-59-01-005-5	53 / 53		13,400	20,500	76,000	19,300	NO	BSL	
7440-36-0	Antimony	0.96	J	43.9	J	WS-59-01-015-14	11 / 53	1.6 - 1.8	43.9	6.55	31	5.9	YES	ASL	
7440-38-2	Arsenic	3.6	J	7.3	J	WS-59-01-014-5	53 / 53		7.3	21.5	0.39	8.2	YES	ASL	
7440-39-3	Barium	53.6		135		WS-59-01-015-14	53 / 53		135	159	5,400	300	NO	BSL	
7440-41-7	Beryllium	0.14	J	0.69		WS-59-01-005-4	53 / 53		0.69	1.4	150	1.1	NO	BSL	
7440-43-9	Cadmium	0.29	J	1.2		WS-59-01-016-5	52 / 53	0.14 - 0.14	1.2	2.9	37	2.3	NO	BSL	
7440-70-2	Calcium	17,500		100,000		WS-59-01-016-20	53 / 53		100,000	293,000	2,500,000	121,000	NO	NUT	
7440-47-3	Chromium	11.4	J	35		WS-59-01-016-18	53 / 53		35	32.7	210	29.6	NO	BSL	
7440-48-4	Cobalt	6.1	J	13.9		WS-59-01-006-9	53 / 53		13.9	29.1	900	30	NO	BSL	
7440-50-8	Copper	18.4	J	51.8	J	WS-59-01-016-18	53 / 53		51.8	62.8	3,100	33	NO	BSL	
7439-89-6	Iron	14,900		26,500		WS-59-01-008-2	53 / 53		26,500	38,600	23,000	36,500	YES	ASL	
7439-92-1	Lead	15.4	J	1,440	J	WS-59-01-016-10	53 / 53		1,440	266	400	24.8	YES	ASL	
7439-95-4	Magnesium	4,890		26,600	J	WS-59-01-008-3	53 / 53		26,600	29,100	400,000	21,500	NO	NUT	
7439-96-5	Manganese	321	J	1,220		WS-59-01-016-5	53 / 53		1,220	2380	1,800	1,060	NO	BSL	
7439-97-6	Mercury	0.04	J	0.52	J	WS-59-04-010-8	53 / 53		0.52	0.13	23	0.1	NO	BSL	
7440-02-0	Nickel	19.1	J	56.6		WS-59-01-007-12	53 / 53		56.6	62.3	1,600	49	NO	BSL	
7440-09-7	Potassium	781		1,580	J	WS-59-01-011-1	53 / 53		1,580	3,160	5,000,000	2,380	NO	NUT	
7782-49-2	Selenium	0.69	J	0.72	J	WS-59-01-013-2	2 / 53	0.135 - 0.6	0.72	1.7	390	2	NO	BSL	
7440-22-4	Silver	0.56		4.7		WS-59-01-016-18	9 / 53	0.055 - 0.305	4.7	0.87	390	0.75	NO	BSL	
7440-23-5	Sodium	68.5		525		WS-59-01-016-4	53 / 53		525	269	1,125,000	172	NO	NUT	
7440-28-0	Thallium	0.56	J	0.99	J	WS-59-01-015-16	27 / 53	0.095 - 0.295	0.99	1.2	5.2	0.7	NO	BSL	
7440-62-2	Vanadium	13.4		35.4		WS-59-01-007-10	53 / 53		35.4	32.7	78	150	NO	BSL	
7440-66-6	Zinc	57	J	185	J	WS-59-01-006-9	53 / 53		185	126	23,000	110	NO	BSL	

TABLE 6-2C
OCCURRENCE, DISTRIBUTION AND SELECTION OF CHEMICALS OF POTENTIAL CONCERN IN SEAD-59 STOCKPILE SOIL
SEAD-59 AND SEAD-71 PHASE II RI
Seneca Army Depot Activity

Scenario Time frame:	Current/Future
Medium:	Soil
Exposure Medium:	Soil
Exposure Point:	SEAD-59 Stockpile

CAS Number	Chemical	Minimum Detected Concentration ¹ (mg/kg)	Q	Maximum Detected Concentration ¹ (mg/kg)	Q	Location of Maximum Concentration	Detection Frequency ¹	Range of Reporting Limits ¹ (mg/kg)	Concentration Used for Screening ² (mg/kg)	Background Value ³ (mg/kg)	Screening Value ⁴ (mg/kg)	Potential ARAR/TBC Value ⁵ (mg/kg)	COPC Flag	Rationale for Contaminant Deletion or Selection ⁶
------------	----------	---	---	---	---	-----------------------------------	----------------------------------	--	---	---------------------------------------	--------------------------------------	---	-----------	--

Notes:

- Field duplicates were averaged and regarded as one sample entry. Lab duplicates were not included in the assessment. Range of reporting limits were presented for nondetects only.
- The maximum detected concentration was used for screening.
- Background value is the maximum Seneca background concentrations.
- EPA Region 9 Preliminary Remediation Goals (PRGs) for residential soil. On-line resources available at <http://www.epa.gov/region09/waste/sfund/prg/files/prgtable2004.xls>. Last updated October 2004.
 Target Cancer Risk = 1E-6; Target Hazard Quotient = 1. Direct contact exposure (ingestion and dermal contact) is evaluated to derive the PRGs. EPA Region III Risk Based Concentration (RBC) for residential soil was used as screening value for 2-methylnaphthalene as no Region 9 PRG is available. EPA Region III RBC, available on-line at <http://www.epa.gov/reg3hwmd/risk/human/rbc/rbc1004.XLS>, was calculated based on soil ingestion exposure and a target cancer risk of 1E-6 and a target hazard quotient of 1.
 PRG for gamma-chlordane was used as screening value for alpha-chlordane.
 PRG for endrin was used as screening value for endrin ketone.
 Screening values for calcium, magnesium, potassium, and sodium were calculated based on an assumption of 200 mg/day soil ingestion and recommended dietary allowances and adequate intakes for 1-3 yr children (500 mg/day and 80 mg/day for calcium and magnesium) and minimum requirements for 1 yr children (225 mg/day and 1000 mg/day for sodium and potassium) from Marilyn Wright (2001) Dietary Reference Intakes.
 PRG for total chromium (1:6 ratio Cr VI: Cr III) was used as screening value for chromium.
 PRG for nickel (soluble salts) was used as screening value for nickel.
- Potential ARAR/TBC values are from NYSDEC Technical and Administrative Guidance Memorandum #4046 (on-line resources available at <http://www.dec.state.ny.us/website/der/tagms/prtg4046.html>)
- Rationale codes
 Selection Reason: Above Screening Levels (ASL)
 Chemicals in the Same Group were retained as COPC (CSG)
 Deletion Reason: Essential Nutrient (NUT)
 Below Screening Level (BSL)
 No Screening Value or Toxicity Value (NSV)

Definitions:

COPC = Chemical of Potential Concern
 ARAR/TBC = Applicable or Relevant and Appropriate Requirement/To Be Considered
 Q = Qualifier
 J = Estimated Value
 NJ = Presence of the analyte has been "tentatively identified" and the associated numerical value represents its approximate concentration.

**TABLE 6-3A
OCCURRENCE, DISTRIBUTION AND SELECTION OF CHEMICALS OF POTENTIAL CONCERN IN SEAD-59 SITE GROUNDWATER
SEAD-59 AND SEAD-71 PHASE II RI
SENECA ARMY DEPOT ACTIVITY**

Scenario Timeframe:	Current/Future
Medium:	Groundwater
Exposure Medium:	Groundwater
Exposure Point:	Aquifer -- Tap Water

CAS Number	Chemical	Minimum Detected Concentration ¹ (ug/L)	Q	Maximum Detected Concentration ¹ (ug/L)	Q	Location of Maximum Concentration	Detection Frequency ¹	Range of Reporting Limits ¹ (ug/L)	Concentration Used for Screening ² (ug/L)	Background Value ³ (ug/L)	Screening Value ⁴ (ug/L)	Potential ARAR /TBC Value (ug/L)	Potential ARAR/TBC Source	COPC Flag	Rationale for Contaminant Deletion or Selection ⁵
VOC															
71-55-6	1,1,1-Trichloroethane	0.45	J	0.45	J	MW59-3	1 / 13	0.5 - 10	0.45		3,200	5	GA	NO	BSL
108-88-3	Toluene	0.27	J	0.27	J	MW59-3	1 / 13	0.5 - 10	0.27		720	5	GA	NO	BSL
SVOC															
84-74-2	Di-n-butylphthalate	2.3	J	2.3	J	MW59-7	1 / 13	9.7 - 11	2.3		3,600	50	GA	NO	BSL
108-95-2	Phenol	1	J	2	J	MW59-2	2 / 13	9.7 - 10.8	2		11,000	1	GA	NO	BSL
Pesticides															
72-55-9	4,4'-DDE	0.008	J	0.008	J	MW59-1	2 / 10	0.04 - 0.04	0.008		0.20	0.2	GA	NO	BSL
50-29-3	4,4'-DDT	0.042	J	0.042	J	MW59-3	1 / 10	0.04 - 0.04	0.042		0.20	0.2	GA	NO	BSL
Metals															
7429-90-5	Aluminum	26.8	J	3,250		MW59-6	12 / 13	14.7 - 14.7	3,250	2,730	36,000	50	SEC	NO	BSL
7440-36-0	Antimony	5.49	J	8.6	J	MW59-3	4 / 13	0.99 - 10	8.6	8.2	15	3	GA	NO	BSL
7440-38-2	Arsenic	2	J	2	J	MW59-1	1 / 13	2 - 22.4	2	1.7	0.045	10	MCL	YES	ASL
7440-39-3	Barium	54.7		132		MW59-2	13 / 13		132	78.2	2,600	1,000	GA	NO	BSL
7440-43-9	Cadmium	0.335	J	0.9	J	MW59-3	4 / 13	0.1 - 5	0.9	0.5	18	5	GA	NO	BSL
7440-70-2	Calcium	102,000		169,000		MW59-3	13 / 13		169,000	116,000	250,000			NO	NUT
7440-47-3	Chromium	0.53	J	3.6	J	MW59-3	8 / 13	0.5 - 5	3.6	4.7	110	50	GA	NO	BSL
7440-48-4	Cobalt	0.68	J	3.5	J	MW59-1	7 / 13	0.54 - 5	3.5	3.7	730			NO	BSL
7440-50-8	Copper	1.42	J	4.65	J	MW59-6	6 / 13	0.5 - 5	4.65	3.3	1,500	200	GA	NO	BSL
7439-89-6	Iron	60.9	J	3,940	J	MW59-3	13 / 13		3,940	4,480	11,000	300	GA	NO	BSL
7439-92-1	Lead	1.5	J	4.4	J	MW59-7	6 / 13	0.9 - 5	4.4	2.5	15	15	MCL	NO	BSL
7439-95-4	Magnesium	12,800		29,200		MW59-2	13 / 13		29,200	28,600	40,000			NO	NUT
7439-96-5	Manganese	9.11		780		MW59-1	13 / 13		780	224	880	50	SEC	NO	BSL
7439-97-6	Mercury	0.05	J	0.06	J	MW59-3	2 / 13	0.03 - 0.2	0.06	0.04	11	0.7	GA	NO	BSL
7440-02-0	Nickel	0.812	J	7.6	J	MW59-1	10 / 13	0.69 - 5	7.6	7.3	730	100	GA	NO	BSL
7440-09-7	Potassium	817	J	4150	J	MW59-3	13 / 13		4,150	3,830	700,000			NO	NUT
7782-49-2	Selenium	4.2	J	4.2	J	MW59-8	1 / 10	1.7 - 5	4.2	1.5	180	10	GA	NO	BSL
7440-23-5	Sodium	22,000		304,000		MW59-3	13 / 13		304,000	14,600	1,200,000	20,000	GA	NO	NUT
7440-28-0	Thallium	2.8	J	4	J	MW59-2	2 / 13	1.6 - 20	4	1.5	2.4	2	MCL	YES	ASL
7440-62-2	Vanadium	1.1	J	5.26		MW59-6	5 / 13	0.61 - 5	5.26	5.2	36			NO	BSL
7440-66-6	Zinc	1.5	J	26.2		MW59-3	13 / 13		26.2	23.1	11,000	5,000	SEC	NO	BSL

**TABLE 6-3A
 OCCURRENCE, DISTRIBUTION AND SELECTION OF CHEMICALS OF POTENTIAL CONCERN IN SEAD-59 SITE GROUNDWATER
 SEAD-59 AND SEAD-71 PHASE II RI
 SENECA ARMY DEPOT ACTIVITY**

Notes:

1. Field duplicates were averaged and regarded as one sample entry. Lab duplicates were not included in the assessment
 Range of reporting limits were presented for nondetects only.
2. The maximum detected concentration was used for screening.
3. Background values are average concentrations of background sample results.
4. EPA Region 9 Preliminary Remediation Goals (PRGs) for tap water. On-line resources available at
<http://www.epa.gov/region09/waste/sfund/prg/files/prgtable2004.xls>. Last updated October 2004.
 Target Cancer Risk = 1E-6; Target Hazard Quotient =1. Ingestion from drinking and inhalation of volatiles during showering are evaluated to derive the PRGs
 MCL for lead was used as screening value for lead as no Region 9 PRG is available
 PRG for endrin was used as screening value for endrin ketone.
 Screening values for calcium, magnesium, potassium, and sodium were calculated based on an assumption of 2L/day water intake
 and recommended dietary allowances and adequate intakes for 1-3 yr children (500 mg/day and 80 mg/day for calcium and magnesium) and
 minimum requirements for 2-5 yr children (1400 mg/day for potassium) from Marilyn Wright (2001) Dietary Reference Intakes.
 For sodium, an upper limit intake of 2,400 mg/day (<http://www.mealformation.com/dailyval.html>) was used
 PRG for chromium (VI) was used as screening value for chromium

5. Rationale codes
- | | |
|-------------------|------------------------------|
| Selection Reason: | Above Screening Levels (ASL) |
| Deletion Reason: | Essential Nutrient (NUT) |
| | Below Screening Level (BSL) |

Definitions:

COPC = Chemical of Potential Concern
 ARAR/TBC = Applicable or Relevant and Appropriate Requirement/To Be Considered
 MCL = Federal Maximum Contaminant Level
 GA = New York State Class GA Groundwater Standard (TOGS 1.1.1, June 1998 with updates)
 SEC = USEPA Secondary Drinking Water Regulation, non-enforceable (EPA 822-B-00-001, Summer 2000)
 Q = Qualifier
 J = Estimated Value

**TABLE 6-3B
OCCURRENCE, DISTRIBUTION AND SELECTION OF CHEMICALS OF POTENTIAL CONCERN IN SEAD-71 GROUNDWATER
SEAD-59 AND SEAD-71 PHASE II RI
SENECA ARMY DEPOT ACTIVITY**

Scenario Timeframe:	Current/Future
Medium:	Groundwater
Exposure Medium:	Groundwater
Exposure Point:	Aquifer -- Tap Water

CAS #	Chemical	Minimum Detected Concentration ¹ (ug/L)	Q	Maximum Detected Concentration ¹ (ug/L)	Q	Location of Maximum Concentration	Detection Frequency ¹	Range of Reporting Limits ¹ (ug/L)	Concentration Used for Screening ² (ug/L)	Background Value ³ (ug/L)	Screening Value ⁴ (ug/L)	Potential ARAR /TBC Value (ug/L)	ARAR/ TBC Source	COPC Flag	Rationale for COPC Deletion or Selection ⁵
VOC															
71-55-6	1,1,1-Trichloroethane	2.5		3.1		MW71-4	2 / 8	0.5 - 10	3.1		3,200	5	GA	NO	BSL
SVOC															
100-01-6	4-Nitroaniline	8.7	J	8.7	J	MW71-2	1 / 8	9.6 - 32	8.7		3.2	5	GA	YES	ASL
117-81-7	Bis(2-Ethylhexyl)phthalate	1.6	J	1.6	J	MW71-3	1 / 8	9.6 - 16	1.6		4.8	5	GA	NO	BSL
Pesticides															
72-55-9	4,4'-DDE	0.006	J	0.013	J	MW71-4	2 / 6	0.0388 - 0.0408	0.013		0.20	0.2	GA	NO	BSL
50-29-3	4,4'-DDT	0.030	J	0.0437		MW71-4	3 / 6	0.0388 - 0.04	0.0437		0.20	0.2	GA	NO	BSL
53494-70-5	Endrin ketone	0.008	J	0.008	J	MW71-3	1 / 6	0.0375 - 0.0408	0.008		11	5	GA	NO	BSL
Metals															
7429-90-5	Aluminum	51.2	J	19,700		MW71-1	5 / 8	14.7 - 100	19,700	2,730	36,000	50	SEC	NO	BSL
7440-36-0	Antimony	6.28	J	6.52	J	MW71-1	2 / 8	1 - 10	6.52	8.2	15	3	GA	NO	BSL
7440-38-2	Arsenic	2.7	J	2.7	J	MW71-1	1 / 8	2 - 22.4	2.7	1.7	0.045	10	MCL	YES	ASL
7440-39-3	Barium	37.1		164	J	MW71-1	8 / 8		164	78.2	2,600	1,000	GA	NO	BSL
7440-41-7	Beryllium	0.819		0.88	J	MW71-1	2 / 8	0.1 - 5	0.88	0.21	73	4	MCL	NO	BSL
7440-43-9	Cadmium	0.33	J	0.33	J	MW71-1	1 / 8	0.2 - 5	0.33	0.5	18	5	GA	NO	BSL
7440-70-2	Calcium	97,800		218,000		MW71-1	8 / 8		218,000	116,000	250,000			NO	NUT
7440-47-3	Chromium	0.59	J	33.1		MW71-1	4 / 8	0.503 - 5	33.1	4.7	110	50	GA	NO	BSL
7440-48-4	Cobalt	0.631	J	22.1	J	MW71-1	4 / 8	0.541 - 5	22.1	3.7	730			NO	BSL
7440-50-8	Copper	0.75	J	16.1	J	MW71-1	4 / 8	1.39 - 5	16.1	3.3	1,500	200	GA	NO	BSL
7439-89-6	Iron	22.9	J	35,100		MW71-1	8 / 8		35,100	4,480	11,000	300	GA	YES	ASL
7439-92-1	Lead	2.1	J	17.2		MW71-1	3 / 8	0.89 - 5	17.2	2.5	15	15	MCL	YES	ASL
7439-95-4	Magnesium	12,500		32,400		MW71-1	8 / 8		32,400	28,600	40,000			NO	NUT
7439-96-5	Manganese	8.1		2,680		MW71-2	7 / 8	0.296 - 0.296	2,680	224	880	50	SEC	YES	ASL
7439-97-6	Mercury	0.05	J	0.069	J	MW71-3	3 / 8	0.047 - 0.2	0.069	0.04	11	0.7	GA	NO	BSL
7440-02-0	Nickel	0.74	J	49.4		MW71-1	6 / 8	0.69 - 0.69	49.4	7.3	730	100	GA	NO	BSL
7440-09-7	Potassium	765	J	4,910	J	MW71-3	8 / 8		4,910	3,830	700,000			NO	NUT
7440-23-5	Sodium	4,130	J	62,200		MW71-3	8 / 8		62,200	14,600	1,200,000	20,000	GA	NO	NUT
7440-28-0	Thallium	2.5	J	2.5	J	MW71-3	1 / 8	1.6 - 20	2.5	1.5	2.4	2	MCL	YES	ASL
7440-62-2	Vanadium	0.9	J	25.7	J	MW71-1	3 / 8	0.606 - 5	25.7	5.2	36			NO	BSL
7440-66-6	Zinc	1.6	J	97.3		MW71-1	8 / 8		97.3	23.1	11,000	5,000	SEC	NO	BSL

TABLE 6-3B
OCCURRENCE, DISTRIBUTION AND SELECTION OF CHEMICALS OF POTENTIAL CONCERN IN SEAD-71 GROUNDWATER
SEAD-59 AND SEAD-71 PHASE II RI
SENECA ARMY DEPOT ACTIVITY

Scenario Timeframe:	Current/Future
Medium:	Groundwater
Exposure Medium:	Groundwater
Exposure Point:	Aquifer -- Tap Water

CAS #	Chemical	Minimum Detected Concentration ¹ Q (ug/L)	Maximum Detected Concentration ¹ Q (ug/L)	Location of Maximum Concentration	Detection Frequency ¹	Range of Reporting Limits ¹ (ug/L)	Concentration Used for Screening ² (ug/L)	Background Value ³ (ug/L)	Screening Value ⁴ (ug/L)	Potential ARAR /TBC Value (ug/L)	ARAR/TBC Source	COPC Flag	Rationale for COPC Deletion or Selection ⁵
-------	----------	--	--	-----------------------------------	----------------------------------	---	--	--------------------------------------	-------------------------------------	----------------------------------	-----------------	-----------	---

Notes:

- Field duplicates were averaged and regarded as one sample entry. Lab duplicates were not included in the assessment. Range of reporting limits were presented for nondetects only.
 - The maximum detected concentration was used for screening.
 - Background values are average concentrations of background sample results.
 - EPA Region 9 Preliminary Remediation Goals (PRGs) for tap water. On-line resources available at <http://www.epa.gov/region09/waste/sfund/prg/files/prgtable2004.xls>. Last updated October 2004. Target Cancer Risk = 1E-6; Target Hazard Quotient =1. Ingestion from drinking and inhalation of volatiles during showering are evaluated to derive the PRGs. MCL for lead was used as screening value for lead as no Region 9 PRG is available. PRG for endrin was used as screening value for endrin ketone. Screening values for calcium, magnesium, potassium, and sodium were calculated based on an assumption of 2L/day water intake and recommended dietary allowances and adequate intakes for 1-3 yr children (500 mg/day and 80 mg/day for calcium and magnesium) and minimum requirements for 2-5 yr children (1400 mg/day for potassium) from Marilyn Wright (2001) Dietary Reference Intakes. For sodium, an upper limit intake of 2,400 mg/day (<http://www.mealformation.com/dailyval.html>) was used. PRG for chromium (VI) was used as screening value for chromium.
5. Rationale codes
- | | |
|-------------------|------------------------------|
| Selection Reason: | Above Screening Levels (ASL) |
| Deletion Reason: | Essential Nutrient (NUT) |
| | Below Screening Level (BSL) |

Definitions:

COPC = Chemical of Potential Concern
ARAR/TBC = Applicable or Relevant and Appropriate Requirement/To Be Considered
MCL = Federal Maximum Contaminant Level
GA = New York State Class GA Groundwater Standard (TOGS 1.1.1, June 1998 with updates)
SEC = USEPA Secondary Drinking Water Regulation, non-enforceable (EPA 822-B-00-001, Summer 2000)
Q = Qualifier
J = Estimated Value

TABLE 6-4A
SOIL EXPOSURE POINT CONCENTRATION SUMMARY - SURFACE SOIL FOR SEAD-59
SEAD-59 AND SEAD-71 PHASE II RI
SENECA ARMY DEPOT ACTIVITY

Scenario Timeframe:	Current/Future
Medium:	Soil
Exposure Medium:	Soil
Exposure Point:	SEAD-59

Chemical of Potential Concern	Units	Arithmetic Mean (1)	95% UCL of Normal Data (1)	Maximum Detected Concentration (1)	Q	EPC Units	Reasonable Maximum Exposure (2)			Central Tendency (2)		
							Medium EPC Value	Medium EPC Statistic	Medium EPC Rationale	Medium EPC Value	Medium EPC Statistic	Medium EPC Rationale
Surface Soil												
Benzo(a)anthracene	mg/kg	0.8	1.0	8.9	J	mg/kg	1.4	97.5 Chebyshev	Non-parametric, MH	1.4	97.5 Chebyshev	Non-parametric, MH
Benzo(a)pyrene	mg/kg	0.9	1.0	8.1	J	mg/kg	1.4	97.5 Chebyshev	Non-parametric, MH	1.4	97.5 Chebyshev	Non-parametric, MH
Benzo(b)fluoranthene	mg/kg	0.8	0.9	6.8	J	mg/kg	1.3	97.5 Chebyshev	Non-parametric, MH	1.3	97.5 Chebyshev	Non-parametric, MH
Benzo(k)fluoranthene	mg/kg	0.7	0.8	7.4	J	mg/kg	1.1	97.5 Chebyshev	Non-parametric, MH	1.1	97.5 Chebyshev	Non-parametric, MH
Chrysene	mg/kg	0.8	1.0	8.9	J	mg/kg	1.4	97.5 Chebyshev	Non-parametric, MH	1.4	97.5 Chebyshev	Non-parametric, MH
Dibenz(a,h)anthracene	mg/kg	0.3	0.3	1.7	J	mg/kg	0.35	95% Chebyshev	Non-parametric, MO	0.35	95% Chebyshev	Non-parametric, MO
Indeno(1,2,3-cd)pyrene	mg/kg	0.5	0.6	4.95	J	mg/kg	0.88	97.5% Chebyshev	Non-parametric, MH	0.88	97.5% Chebyshev	Non-parametric, MH
4,4'-DDE	mg/kg	0.04	0.06	2.6		mg/kg	0.13	97.5% Chebyshev	Non-parametric, MH	0.13	97.5% Chebyshev	Non-parametric, MH
4,4'-DDT	mg/kg	0.051	0.086	3.7		mg/kg	0.18	97.5% Chebyshev	Non-parametric, MH	0.18	97.5% Chebyshev	Non-parametric, MH
Antimony	mg/kg	4.0	7.7	424	J	mg/kg	13.9	95% Chebyshev	Non-parametric, MO	13.9	95% Chebyshev	Non-parametric, MO
Arsenic	mg/kg	5.4	5.7	32.2		mg/kg	5.8	95% modified t	Non-parametric, M	5.8	95% modified t	Non-parametric, M
Iron	mg/kg	21,212	21,830	64,000	J	mg/kg	21,844	95% modified t	Non-parametric, M	21,844	95% modified t	Non-parametric, M

Notes:

- Field duplicates were averaged and regarded as one sample entry. Lab duplicates were not included in the assessment. Nondetectes were assumed to be half reporting limits.
- The EPCs were calculated using the ProUCL (Version 3.00.02) and the EPCs were selected in accordance with the ProUCL Version 3.0 User Guide (USEPA, 2004) and the Calculating Upper Confidence Limits for Exposure Point Concentrations at Hazardous Waste Sites (USEPA, 2002).
 HE - highly skewed to extremely highly skewed (standard deviation of log-transformed data in the interval (2.0, 3.0] data set.
 MH - moderately to highly skewed (standard deviation of log-transformed data in the interval (1.0, 2.0] data set.
 MO - moderately skewed (standard deviation of log-transformed data in the interval (0.5,1] data set.
 M - mildly skewed (standard deviation of log-transformed data less than or equal to 0.5) data set.
 Q - qualifier
 J = Estimated Value

TABLE 6-4B
SOIL EXPOSURE POINT CONCENTRATION SUMMARY - SURFACE SOIL FOR SEAD-71
SEAD-59 AND SEAD-71 PHASE II RI
SENECA ARMY DEPOT ACTIVITY

Scenario Timeframe:	Current/Future
Medium:	Soil
Exposure Medium:	Soil
Exposure Point:	SEAD-71

Chemical of Potential Concern	Units	Arithmetic Mean (1)	95% UCL of Normal Data (1)	Maximum Detected Concentration (1)	Q	EPC Units	Reasonable Maximum Exposure (2)			Central Tendency (2)		
							Medium EPC Value	Medium EPC Statistic	Medium EPC Rationale	Medium EPC Value	Medium EPC Statistic	Medium EPC Rationale
Surface Soil												
Benzo(a)anthracene	mg/kg	9.1	14.7	150		mg/kg	42.6	99% Chebyshev	Non-parametric, HE	42.6	99% Chebyshev	Non-parametric, HE
Benzo(a)pyrene	mg/kg	7.7	12.2	120		mg/kg	34.8	99% Chebyshev	Non-parametric, HE	34.8	99% Chebyshev	Non-parametric, HE
Benzo(b)fluoranthene	mg/kg	6.5	10.1	88		mg/kg	28.2	99% Chebyshev	Non-parametric, HE	28.2	99% Chebyshev	Non-parametric, HE
Benzo(k)fluoranthene	mg/kg	7.8	12.4	130		mg/kg	35.7	99% Chebyshev	Non-parametric, HE	35.7	99% Chebyshev	Non-parametric, HE
Carbazole	mg/kg	4.7	8.2	77		mg/kg	25.5	99% Chebyshev	Non-parametric, HE	25.5	99% Chebyshev	Non-parametric, HE
Chrysene	mg/kg	9.2	14.6	150		mg/kg	41.6	99% Chebyshev	Non-parametric, HE	41.6	99% Chebyshev	Non-parametric, HE
Dibenz(a,h)anthracene	mg/kg	1.7	2.7	25	J	mg/kg	5.4	97.5% Chebyshev	Non-parametric, MH	5.4	97.5% Chebyshev	Non-parametric, MH
Indeno(1,2,3-cd)pyrene	mg/kg	4.1	6.4	65	J	mg/kg	12.8	97.5% Chebyshev	Non-parametric, MH	12.8	97.5% Chebyshev	Non-parametric, MH
Heptachlor epoxide	mg/kg	0.0068	0.011	0.18		mg/kg	0.024	97.5% Chebyshev	Non-parametric, MH	0.024	97.5% Chebyshev	Non-parametric, MH
Arsenic	mg/kg	6.0	6.4	14.6		mg/kg	6.3	95% H, 95% Approximate Gamma	Gamma Lognormal	6.3	95% H, 95% Approximate Gamma	Gamma Lognormal
Iron	mg/kg	23,117	24,756	65,100		mg/kg	24,790	95% modified t	Non-parametric, M	24,790	95% modified t	Non-parametric, M
Lead	mg/kg	166.3	N/A	3,470	J	mg/kg	166.3	Mean	Mean	166.3	Mean	Mean

Notes:

- Field duplicates were averaged and regarded as one sample entry. Lab duplicates were not included in the assessment. Nondetects were assumed to be half reporting limits.
- The EPCs were calculated using the ProUCL (Version 3.00.02) and the EPCs were selected in accordance with the ProUCL Version 3.0 User Guide (USEPA, 2004) and the Calculating Upper Confidence Limits for Exposure Point Concentrations at Hazardous Waste Sites (USEPA, 2002). The average lead concentration was used as the lead EPC in accordance with the User's Guide for the Integrated Exposure Uptake Biokinetic Model for Lead in Children (IEUBK) Windows® Version – 32 bit Version (USEPA, 2002).
 - HE - highly skewed to extremely highly skewed (standard deviation of log-transformed data in the interval (2.0, 3.0] data set.
 - MH - moderately to highly skewed (standard deviation of log-transformed data in the interval (1.0, 2.0] data set.
 - M - mildly skewed (standard deviation of log-transformed data less than or equal to 0.5) data set.
 - Q - qualifier
 - J = Estimated Value

TABLE 6-4C
SOIL EXPOSURE POINT CONCENTRATION SUMMARY - SEAD-59 STOCKPILE SOII
SEAD-59 AND SEAD-71 PHASE II RI
SENECA ARMY DEPOT ACTIVITY

Scenario Timeframe:	Current/Future
Medium:	Soil
Exposure Medium:	Soil
Exposure Point:	SEAD-59 Stockpile

Chemical of Potential Concern	Units	Arithmetic Mean (1)	95% UCL of Normal Data (1)	Maximum Detected Concentration (1)	Q	EPC Units	Reasonable Maximum Exposure (2)			Central Tendency (2)		
							Medium EPC Value	Medium EPC Statistic	Medium EPC Rationale	Medium EPC Value	Medium EPC Statistic	Medium EPC Rationale
Stockpile Soil												
Benzo(a)anthracene	mg/kg	5.0	5.7	14		mg/kg	6.8	95% Chebyshev	Non-parametric, MO	6.8	95% Chebyshev	Non-parametric, MO
Benzo(a)pyrene	mg/kg	5.7	6.5	16		mg/kg	7.9	95% Chebyshev	Non-parametric, MO	7.9	95% Chebyshev	Non-parametric, MO
Benzo(b)fluoranthene	mg/kg	4.3	4.9	11		mg/kg	5.1	95% Approximate Gamma	Approximate Gamma	5.1	95% Approximate Gamma	Approximate Gamma
Benzo(k)fluoranthene	mg/kg	4.2	4.9	13		mg/kg	6.7	97.5 Chebyshev	Non-parametric, MH	6.7	97.5 Chebyshev	Non-parametric, MH
Chrysene	mg/kg	5.0	5.7	13		mg/kg	6.8	95% Chebyshev	Non-parametric, MO	6.8	95% Chebyshev	Non-parametric, MO
Dibenz(a,h)anthracene	mg/kg	1.1	1.2	2.9	J	mg/kg	1.2	95% Student's t	Normal	1.2	95% Student's t	Normal
Indeno(1,2,3-cd)pyrene	mg/kg	3.0	3.5	8	J	mg/kg	3.5	95% Student's t	Normal	3.5	95% Student's t	Normal
Antimony	mg/kg	3.1	4.5	43.9	J	mg/kg	6.8	95% Chebyshev	Non-parametric, MO	6.8	95% Chebyshev	Non-parametric, MO
Arsenic	mg/kg	4.8	4.9	7.3	J	mg/kg	4.9	95% Approximate Gamma, H	Approximate Gamma, Lognormal	4.9	95% Approximate Gamma, H	Approximate Gamma, Lognormal
Iron	mg/kg	20,590	21,147	26,500	J	mg/kg	21,147	95% Student's t	Normal	21,147	95% Student's t	Normal
Lead	mg/kg	79	N/A	1,440	J	mg/kg	79	Mean	See Note	79	Mean	See Note

Notes:

- Field duplicates were averaged and regarded as one sample entry. Lab duplicates were not included in the assessment. Nondetects were assumed to be half reporting limits.
- The EPCs were calculated using the ProUCL (Version 3.00.02) and the EPCs were selected in accordance with the ProUCL Version 3.0 User Guide (USEPA, 2004) and the Calculating Upper Confidence Limits for Exposure Point Concentrations at Hazardous Waste Sites (USEPA, 2002). The average lead concentration was used as the lead EPC in accordance with the User's Guide for the Integrated Exposure Uptake Biokinetic Model for Lead in Children (IEUBK) Windows® Version – 32 bit Version (USEPA, 2002).
 - HE - highly skewed to extremely highly skewed (standard deviation of log-transformed data in the interval (2.0, 3.0] data set.
 - MH - moderately to highly skewed (standard deviation of log-transformed data in the interval (1.0, 2.0] data set.
 - MO - moderately skewed (standard deviation of log-transformed data in the interval (0.5,1] data set.
 - M - mildly skewed (standard deviation of log-transformed data less than or equal to 0.5) data set.
 - Q - qualifier
 - J = Estimated Value

TABLE 6-5A
SOIL EXPOSURE POINT CONCENTRATION SUMMARY - SURFACE AND SUBSURFACE SOIL FOR SEAD-59
SEAD-59 AND SEAD-71 PHASE II RI
SENECA ARMY DEPOT ACTIVITY

Scenario Timeframe:	Current/Future
Medium:	Soil
Exposure Medium:	Soil
Exposure Point:	SEAD-59

Chemical of Potential Concern	Units	Arithmetic Mean (1)	95% UCL of Normal Data (1)	Maximum Detected Concentration (1)	Q	EPC Units	Reasonable Maximum Exposure (2)			Central Tendency (2)		
							Medium EPC Value	Medium EPC Statistic	Medium EPC Rationale	Medium EPC Value	Medium EPC Statistic	Medium EPC Rationale
Surface and Subsurface Soil												
Benzo(a)anthracene	mg/kg	0.8	0.9	8.9	J	mg/kg	1.4	97.5 Chebyshev	Non-parametric, MH	1.4	97.5 Chebyshev	Non-parametric, MH
Benzo(a)pyrene	mg/kg	0.9	1.0	8.1	J	mg/kg	1.4	97.5 Chebyshev	Non-parametric, MH	1.4	97.5 Chebyshev	Non-parametric, MH
Benzo(b)fluoranthene	mg/kg	0.8	0.9	6.8	J	mg/kg	1.2	97.5 Chebyshev	Non-parametric, MH	1.2	97.5 Chebyshev	Non-parametric, MH
Benzo(k)fluoranthene	mg/kg	0.7	0.8	7.4	J	mg/kg	1.2	97.5 Chebyshev	Non-parametric, MH	1.2	97.5 Chebyshev	Non-parametric, MH
Chrysene	mg/kg	0.8	1.0	8.9	J	mg/kg	1.4	97.5 Chebyshev	Non-parametric, MH	1.4	97.5 Chebyshev	Non-parametric, MH
Dibenz(a,h)anthracene	mg/kg	0.3	0.3	1.7	J	mg/kg	0.40	95% Chebyshev	Non-parametric, MO	0.40	95% Chebyshev	Non-parametric, MO
Indeno(1,2,3-cd)pyrene	mg/kg	0.5	0.6	4.95	J	mg/kg	0.87	97.5% Chebyshev	Non-parametric, MH	0.87	97.5% Chebyshev	Non-parametric, MH
4,4'-DDE	mg/kg	0.04	0.06	2.6		mg/kg	0.12	97.5% Chebyshev	Non-parametric, MH	0.12	97.5% Chebyshev	Non-parametric, MH
4,4'-DDT	mg/kg	0.048	0.081	3.7		mg/kg	0.17	97.5% Chebyshev	Non-parametric, MH	0.17	97.5% Chebyshev	Non-parametric, MH
Antimony	mg/kg	3.7	7.2	424	J	mg/kg	13.0	95% Chebyshev	Non-parametric, MO	13.0	95% Chebyshev	Non-parametric, MO
Arsenic	mg/kg	5.4	5.6	32.2		mg/kg	5.7	95% modified t	Non-parametric, M	5.7	95% modified t	Non-parametric, M
Iron	mg/kg	21,152	21,741	64,000	J	mg/kg	21,753	95% modified t	Non-parametric, M	21,753	95% modified t	Non-parametric, M

Notes:

- Field duplicates were averaged and regarded as one sample entry. Lab duplicates were not included in the assessment. Nondetectes were assumed to be half reporting limits.
- The EPCs were calculated using the ProUCL (Version 3.00.02) and the EPCs were selected in accordance with the ProUCL Version 3.0 User Guide (USEPA, 2004) and the Calculating Upper Confidence Limits for Exposure Point Concentrations at Hazardous Waste Sites (USEPA, 2002).
 - HE - highly skewed to extremely highly skewed (standard deviation of log-transformed data in the interval (2.0, 3.0] data set.
 - MH - moderately to highly skewed (standard deviation of log-transformed data in the interval (1.0, 2.0] data set.
 - MO - moderately skewed (standard deviation of log-transformed data in the interval (0.5,1] data set.
 - M - mildly skewed (standard deviation of log-transformed data less than or equal to 0.5) data set.
 - Q - qualifier
 - J = Estimated Value

TABLE 6-5B
SOIL EXPOSURE POINT CONCENTRATION SUMMARY - SURFACE AND SUBSURFACE SOIL FOR SEAD-71
SEAD-59 AND SEAD-71 PHASE II RI
SENECA ARMY DEPOT ACTIVITY

Scenario Timeframe:	Current/Future
Medium:	Soil
Exposure Medium:	Soil
Exposure Point:	SEAD-71

Chemical of Potential Concern	Units	Arithmetic Mean (1)	95% UCL of Normal Data (1)	Maximum Detected Concentration (1)	Q	EPC Units	Reasonable Maximum Exposure (2)			Central Tendency (2)		
							Medium EPC Value	Medium EPC Statistic	Medium EPC Rationale	Medium EPC Value	Medium EPC Statistic	Medium EPC Rationale
Surface and Subsurface Soil												
Benzo(a)anthracene	mg/kg	8.7	13.7	150		mg/kg	39.1	99% Chebyshev	Non-parametric, HE	39.1	99% Chebyshev	Non-parametric, HE
Benzo(a)pyrene	mg/kg	7.2	11.3	120		mg/kg	31.6	99% Chebyshev	Non-parametric, HE	31.6	99% Chebyshev	Non-parametric, HE
Benzo(b)fluoranthene	mg/kg	6.2	9.5	88		mg/kg	25.9	99% Chebyshev	Non-parametric, HE	25.9	99% Chebyshev	Non-parametric, HE
Benzo(k)fluoranthene	mg/kg	7.2	11.4	130		mg/kg	32.3	99% Chebyshev	Non-parametric, HE	32.3	99% Chebyshev	Non-parametric, HE
Carbazole	mg/kg	4.2	7.2	77		mg/kg	22.1	99% Chebyshev	Non-parametric, HE	22.1	99% Chebyshev	Non-parametric, HE
Chrysene	mg/kg	8.7	13.6	150		mg/kg	38.1	99% Chebyshev	Non-parametric, HE	38.1	99% Chebyshev	Non-parametric, HE
Dibenz(a,h)anthracene	mg/kg	1.7	2.6	25	J	mg/kg	5.1	97.5% Chebyshev	Non-parametric, MH	5.1	97.5% Chebyshev	Non-parametric, MH
Indeno(1,2,3-cd)pyrene	mg/kg	3.8	5.9	65	J	mg/kg	11.7	97.5% Chebyshev	Non-parametric, MH	11.7	97.5% Chebyshev	Non-parametric, MH
Heptachlor epoxide	mg/kg	0.006	0.010	0.18		mg/kg	0.022	97.5% Chebyshev	Non-parametric, MH	0.022	97.5% Chebyshev	Non-parametric, MH
Arsenic	mg/kg	5.8	6.2	14.6		mg/kg	6.2	95% t, H, modified t	Lognormal	6.2	95% t, H, modified t	Lognormal
Iron	mg/kg	22,890	24,374	65,100		mg/kg	24,405	95% modified t	Non-parametric, M	24,405	95% modified t	Non-parametric, M
Lead	mg/kg	152.4	N/A	3,470	J	mg/kg	152.4	Mean	Mean	152.4	Mean	Mean

- Notes:
- Field duplicates were averaged and regarded as one sample entry. Lab duplicates were not included in the assessment. Nondetectes were assumed to be half reporting limits.
 - The EPCs were calculated using the ProUCL (Version 3.00.02) and the EPCs were selected in accordance with the ProUCL Version 3.0 User Guide (USEPA, 2004) and the Calculating Upper Confidence Limits for Exposure Point Concentrations at Hazardous Waste Sites (USEPA, 2002). The average lead concentration was used as the lead EPC in accordance with the User's Guide for the Integrated Exposure Uptake Biokinetic Model for Lead in Children (IEUBK) Windows® Version – 32 bit Version (USEPA, 2002)
 - HE - highly skewed to extremely highly skewed (standard deviation of log-transformed data in the interval (2.0, 3.0] data set.
 - MH - moderately to highly skewed (standard deviation of log-transformed data in the interval (1.0, 2.0] data set.
 - M - mildly skewed (standard deviation of log-transformed data less than or equal to 0.5) data set.
 - Q - qualifier
 - J = Estimated Value

TABLE 6-6A
GROUNDWATER EXPOSURE POINT CONCENTRATION SUMMARY - SEAD-59
SEAD-59 AND SEAD-71 PHASE II RI
SENECA ARMY DEPOT ACTIVITY

Scenario Timeframe:	Current/Future
Medium:	Groundwater
Exposure Medium:	Groundwater
Exposure Point:	Aquifer--Tap Water

Chemical of Potential Concern	Units	Arithmetic Mean	Maximum Detected Concentration mg/L	Maximum Qualifier	Reasonable Maximum Exposure			Central Tendency		
					Medium EPC Value (mg/L)	Medium EPC Statistic	Medium EPC Rationale	Medium EPC Value (mg/L)	Medium EPC Statistic	Medium EPC Rationale
Arsenic	mg/L	0.0033	0.002	J	0.002	MDC	See note	0.002	MDC	See note
Thallium	mg/L	0.0064	0.004	J	0.004	MDC	See note	0.004	MDC	See note

Notes:

- Field duplicates were averaged and regarded as one sample entry. Lab duplicates were not included in the assessment. Concentrations for nondetects were assumed to be half the detection limits.
 - The maximum detected concentration was used as EPC for the RME scenario. As residential use of groundwater has been based on the assumption that a single private well can be placed anywhere in the contaminated plume, the MDC across several rounds of monitoring was used as the EPC for groundwater as a conservative step for both the RME and CT scenarios.
 - The maximum detected concentration was used as EPC for the CT scenario.
- EPC = Exposure Point Concentration
MDC = Maximum Detected Concentration
RME = Reasonable Maximum Exposure
CT = Central Tendency

TABLE 6-6B
GROUNDWATER EXPOSURE POINT CONCENTRATION SUMMARY - SEAD-71
SEAD-59 AND SEAD-71 PHASE II RI
SENECA ARMY DEPOT ACTIVITY

Scenario Timeframe:	Current/Future
Medium:	Groundwater
Exposure Medium:	Groundwater
Exposure Point:	SEAD-71

Chemical of Potential Concern	Units	Arithmetic Mean (1)	Maximum Detected Concentration	Maximum Qualifier	EPC Units	RME (2)			CT (3)		
						Medium EPC Value	Medium EPC Statistic	Medium EPC Rationale	Medium EPC Value	Medium EPC Statistic	Medium EPC Rationale
4-Nitroaniline	ug/L	7.8	8.7	J	ug/L	8.7	MDC	See note	8.7	MDC	See note
Arsenic	ug/L	3.1	2.7	J	ug/L	2.7	MDC	See note	2.7	MDC	See note
Iron	ug/L	5,063	35,100		ug/L	35,100	MDC	See note	35,100	MDC	See note
Lead	ug/L	4.2	17.2		ug/L	17.2	MDC	See note	17.2	MDC	See note
Manganese	ug/L	633	2,680		ug/L	2,680	MDC	See note	2,680	MDC	See note
Thallium	ug/L	6.0	2.5	J	ug/L	2.5	MDC	See note	2.5	MDC	See note

Notes:

1. Field duplicates were averaged and regarded as one sample entry. Lab duplicates were not included in the assessment.

Concentrations for nondetects were assumed to be half the detection limits.

2. The maximum detected concentration was used as EPC for the RME scenario.

As residential use of groundwater has been based on the assumption that a single private well can be placed anywhere in the contaminated plume, the MDC across several rounds of monitoring was used as the EPC for groundwater as a conservative step for both the RME and CT scenarios.

3. The maximum detected concentration was used as EPC for the CT scenario.

EPC = Exposure Point Concentration

MDC = Maximum Detected Concentration

RME = Reasonable Maximum Exposure

TABLE 6-7A
 AMBIENT AIR EXPOSURE POINT CONCENTRATIONS - SURFACE SOIL FOR SEAD-59
 SEAD-59 AND SEAD-71 PHASE II RI
 Seneca Army Depot Activity

Scenario Timeframe:	Current/Future
Medium:	Soil
Exposure Medium:	Air
Exposure Point:	SEAD-59

Equation for Air EPC from Surface Soil (mg/m³) = CS_{surf} x PM10 x CF

Variables:
 CS_{surf} = Chemical Concentration in Surface Soil, from EPC data (mg/kg)
 PM10 = Average Measured PM10 Concentration = 17 ug/m³
 CF = Conversion Factor = 1E-9 kg/ug

Analyte	Reasonable Maximum Exposure		Central Tendency Exposure	
	EPC Data for Surface Soil (mg/kg)	Calculated Air EPC Surface Soil (mg/m ³)	EPC Data for Surface Soil (mg/kg)	Calculated Air EPC Surface Soil (mg/m ³)
Benzo(a)anthracene	1.4	2.3E-08	1.4	2.3E-08
Benzo(a)pyrene	1.4	2.4E-08	1.4	2.4E-08
Benzo(b)fluoranthene	1.3	2.1E-08	1.3	2.1E-08
Benzo(k)fluoranthene	1.1	1.9E-08	1.1	1.9E-08
Chrysene	1.4	2.4E-08	1.4	2.4E-08
Dibenz(a,h)anthracene	0.35	6.0E-09	0.35	6.0E-09
Indeno(1,2,3-cd)pyrene	0.88	1.5E-08	0.88	1.5E-08
4,4'-DDE	0.13	2.2E-09	0.13	2.2E-09
4,4'-DDT	0.18	3.1E-09	0.18	3.1E-09
Antimony	13.9	2.4E-07	13.9	2.4E-07
Arsenic	5.8	9.8E-08	5.8	9.8E-08
Iron	21,844	3.7E-04	21,844	3.7E-04

TABLE 6-7B
AMBIENT AIR EXPOSURE POINT CONCENTRATIONS - SURFACE SOIL FOR SEAD-71
SEAD-59 AND SEAD-71 PHASE II RI
Seneca Army Depot Activity

Scenario Timeframe:	Current/Future
Medium:	Soil
Exposure Medium:	Air
Exposure Point:	SEAD-71

Equation for Air EPC from Surface Soil (mg/m³) = CSsurf x PM10 x CF

Variables:
 CSsurf = Chemical Concentration in Surface Soil, from EPC data (mg/kg)
 PM10 = Average Measured PM10 Concentration = 17 ug/m³
 CF = Conversion Factor = 1E-9 kg/ug

Analyte	Reasonable Maximum Exposure		Central Tendency Exposure	
	EPC Data for Surface Soil (mg/kg)	Calculated Air EPC Surface Soil (mg/m ³)	EPC Data for Surface Soil (mg/kg)	Calculated Air EPC Surface Soil (mg/m ³)
Benzo(a)anthracene	42.6	7.2E-07	42.6	7.2E-07
Benzo(a)pyrene	34.8	5.9E-07	34.8	5.9E-07
Benzo(b)fluoranthene	28.2	4.8E-07	28.2	4.8E-07
Benzo(k)fluoranthene	35.7	6.1E-07	35.7	6.1E-07
Carbazole	25.5	4.3E-07	25.5	4.3E-07
Chrysene	41.6	7.1E-07	41.6	7.1E-07
Dibenz(a,h)anthracene	5.4	9.2E-08	5.4	9.2E-08
Indeno(1,2,3-cd)pyrene	12.8	2.2E-07	12.8	2.2E-07
Heptachlor epoxide	0.024	4.1E-10	0.024	4.1E-10
Arsenic	6.3	1.1E-07	6.3	1.1E-07
Iron	24790	4.2E-04	24790	4.2E-04
Lead	166.3	2.8E-06	166.3	2.8E-06

TABLE 6-7C
 AMBIENT AIR EXPOSURE POINT CONCENTRATIONS - SEAD-59 STOCKPILE SOIL
 SEAD-59 AND SEAD-71 PHASE II RI
 Seneca Army Depot Activity

Scenario Timeframe:	Current/Future
Medium:	Soil
Exposure Medium:	Air
Exposure Point:	SEAD-59 Stockpile

Equation for Air EPC from Stockpile Soil (mg/m³) = CS_{surf} x PM10 x CF

Variables:
 CS_{surf} = Chemical Concentration in Stockpile Soil, from EPC data (mg/kg)
 PM10 = Average Measured PM10 Concentration = 17 ug/m³
 CF = Conversion Factor = 1E-9 kg/ug

Analyte	Reasonable Maximum Exposure		Central Tendency Exposure	
	EPC Data for Stockpile Soil (mg/kg)	Calculated Air EPC Stockpile Soil (mg/m ³)	EPC Data for Stockpile Soil (mg/kg)	Calculated Air EPC Stockpile Soil (mg/m ³)
Benzo(a)anthracene	6.8	1.2E-07	6.8	1.2E-07
Benzo(a)pyrene	7.9	1.3E-07	7.9	1.3E-07
Benzo(b)fluoranthene	5.1	8.7E-08	5.1	8.7E-08
Benzo(k)fluoranthene	6.7	1.1E-07	6.7	1.1E-07
Chrysene	6.8	1.2E-07	6.8	1.2E-07
Dibenz(a,h)anthracene	1.2	2.0E-08	1.2	2.0E-08
Indeno(1,2,3-cd)pyrene	3.5	6.0E-08	3.5	6.0E-08
Antimony	6.8	1.2E-07	6.8	1.2E-07
Arsenic	4.9	8.3E-08	4.9	8.3E-08
Iron	21147	3.6E-04	21147	3.6E-04
Lead	79	1.3E-06	79	1.3E-06

TABLE 6-8A
 AMBIENT AIR EXPOSURE POINT CONCENTRATIONS - SURFACE AND SUBSURFACE SOIL FOR SEAD-59
 SEAD-59 AND SEAD-71 PHASE II RI
 Seneca Army Depot Activity

Scenario Timeframe:	Current/Future
Medium:	Soil
Exposure Medium:	Air
Exposure Point:	SEAD-59

Equation for Air EPC from Total Soils (mg/m³) = CStot x PM10 x CF

Variables:
 CStot = Chemical Concentration in Total Soils, from EPC data (mg/kg)
 PM10 = PM10 Concentration Calculated for Construction Worker= 954 ug/m³
 CF = Conversion Factor = 1E-9 kg/ug

Analyte	Reasonable Maximum Exposure		Central Tendency Exposure	
	EPC Data for Surface and Subsurface Soil (mg/kg)	Calculated Air EPC Surface and Subsurface Soil (mg/m ³)	EPC Data for Surface and Subsurface Soil (mg/kg)	Calculated Air EPC Surface and Subsurface Soil (mg/m ³)
Benzo(a)anthracene	1.4	1.3E-06	1.4	1.3E-06
Benzo(a)pyrene	1.4	1.3E-06	1.4	1.3E-06
Benzo(b)fluoranthene	1.2	1.1E-06	1.2	1.1E-06
Benzo(k)fluoranthene	1.2	1.1E-06	1.2	1.1E-06
Chrysene	1.4	1.3E-06	1.4	1.3E-06
Dibenz(a,h)anthracene	0.40	3.8E-07	0.40	3.8E-07
Indeno(1,2,3-cd)pyrene	0.87	8.3E-07	0.87	8.3E-07
4,4'-DDE	0.12	1.1E-07	0.12	1.1E-07
4,4'-DDT	0.17	1.6E-07	0.17	1.6E-07
Antimony	13.0	1.2E-05	13.0	1.2E-05
Arsenic	5.7	5.4E-06	5.7	5.4E-06
Iron	21,753	2.1E-02	21,753	2.1E-02

TABLE 6-8B
AMBIENT AIR EXPOSURE POINT CONCENTRATIONS - SURFACE AND SUBSURFACE SOIL FOR SEAD-71
SEAD-59 AND SEAD-71 PHASE II RI
Seneca Army Depot Activity

Scenario Timeframe:	Current/Future
Medium:	Soil
Exposure Medium:	Air
Exposure Point:	SEAD-71

Equation for Air EPC from Total Soils (mg/m³) = CStot x PM10 x CF

Variables:

CStot = Chemical Concentration in Total Soils, from EPC data (mg/kg)

PM10 = PM10 Concentration Calculated for Construction Worker= 954 ug/m³

CF = Conversion Factor = 1E-9 kg/ug

Analyte	Reasonable Maximum Exposure		Central Tendency Exposure	
	EPC Data for Surface and Subsurface Soil (mg/kg)	Calculated Air EPC Surface and Subsurface Soil (mg/m ³)	EPC Data for Surface and Subsurface Soil (mg/kg)	Calculated Air EPC Surface and Subsurface Soil (mg/m ³)
Benzo(a)anthracene	39.06	3.7E-05	39.06	3.7E-05
Benzo(a)pyrene	31.6	3.0E-05	31.6	3.0E-05
Benzo(b)fluoranthene	25.92	2.5E-05	25.92	2.5E-05
Benzo(k)fluoranthene	32.3	3.1E-05	32.3	3.1E-05
Carbazole	22.1	2.1E-05	22.1	2.1E-05
Chrysene	38.1	3.6E-05	38.1	3.6E-05
Dibenz(a,h)anthracene	5.1	4.9E-06	5.1	4.9E-06
Indeno(1,2,3-cd)pyrene	11.7	1.1E-05	11.7	1.1E-05
Heptachlor epoxide	0.022	2.1E-08	0.022	2.1E-08
Arsenic	6.2	5.9E-06	6.2	5.9E-06
Iron	24405	2.3E-02	24405	2.3E-02
Lead	152.4	1.5E-04	152.4	1.5E-04

**TABLE 6-9A
EXPOSURE FACTOR ASSUMPTIONS FOR SEAD-59 AND SEAD-71
SEAD-59 AND SEAD-71 PHASE II RI
Seneca Army Depot Activity**

Scenario Timeframe:	Current/Future
Medium:	Soil
Exposure Medium:	Soil
Exposure Point:	SEAD-59 and SEAD-71
Receptor Population:	Construction Worker
Receptor Age:	Adult

EXPOSURE ROUTE	PARAMETER CODE	PARAMETER DEFINITION	UNITS	RME VALUE	RME RATIONALE	RME REFERENCE	CT VALUE	CT RATIONALE	CT REFERENCE
Ingestion of Soil	EPC	Soil EPC	mg/kg		Surface and subsurface soil EPC.	Table 5-4C, 5-5A/B		Surface and subsurface soil EPC.	Table 5-4C, 5-5A/B
	BW	Body Weight	kg	70	Default value for construction worker.	USEPA, 2002.	70	Default value for construction worker.	USEPA, 2002.
	IR	Ingestion Rate	mg/day	330	Default value for construction worker.	USEPA, 2002.	100	Default value for outdoor worker.	USEPA, 2002.
	FI	Fraction Ingested	unitless	1	Assuming 100% ingestion from site.	BPJ.	1	Assuming 100% ingestion from site.	BPJ.
	EF	Exposure Frequency	days/yr	250	Default value for construction worker.	USEPA, 2002.	219	Default value for industrial worker.	USEPA, 2004.
	ED	Exposure Duration	year	1	Default value for construction worker.	USEPA, 2002.	1	Default value for construction worker.	USEPA, 2002.
	CF	Conversion Factor	kg/mg	1E-6			1E-6		
	AT(Nc) AT(Cair)	Averaging Time - Nc Averaging Time - Car	days days	365 25,550	1 year. 70 years, default value for construction worker.	USEPA, 2002.	365 25,550	1 year. 70 years, default value for construction worker.	USEPA, 2002.
Dermal Contact of Soil	EPC	Soil EPC	mg/kg		Surface and subsurface soil EPC.	Table 5-4C, 5-5A/B		Surface and subsurface soil EPC.	Table 5-4C, 5-5A/B
	BW	Body Weight	kg	70	Default value for construction worker.	USEPA, 2002.	70	Default value for construction worker.	USEPA, 2002.
	SA	Skin Contact Surface Area	cm ²	3,300	Default value for construction worker.	USEPA, 2002.	3,300	Default value for construction worker.	USEPA, 2002.
	AF	Soil/Skin Adherence Factor	mg/cm ² -event	0.3	Default value for construction worker.	USEPA, 2002.	0.3	Default value for construction worker.	USEPA, 2002.
	ABS	Dermal Absorption Fraction	unitless		Chemical-specific	USEPA, 2004.		Chemical-specific	USEPA, 2004.
	EV	Event Frequency	events/day	1	Default value for construction worker.	USEPA, 2002.	1	Default value for construction worker.	USEPA, 2002.
	EF	Exposure Frequency	days/yr	250	Default value for construction worker.	USEPA, 2002.	219	Default value for industrial worker.	USEPA, 2004.
	ED	Exposure Duration	year	1	Default value for construction worker.	USEPA, 2002.	1	Default value for construction worker.	USEPA, 2002.
	CF	Conversion Factor	kg/mg	1E-6			1E-6		
	AT(Nc)	Averaging Time - Nc	days	365	1 year.		365	1 year.	
	AT(Cair)	Averaging Time - Car	days	25,550	70 years, default value for construction worker.	USEPA, 2002.	25,550	70 years, default value for construction worker.	USEPA, 2002.

Source References:

- BPJ: Best Professional Judgement.
- USEPA, 2002: Supplemental Guidance For Developing Soil Screening Levels For Superfund Sites. December.
- USEPA, 2004: Risk Assessment Guidance for Superfund Volume I: Human Health Evaluation Manual (Part E, Supplemental Guidance for Dermal Risk Assessment) Final.

Intake Equations:

Ingestion Daily Intake (DI) (mg/kg-day) = EPC x IR x EF x ED x CF x FI / (BW x AT)
Dermal DI (mg/kg-day) = EPC x SA x AF x ABS x EV x EF x ED x CF/(BW x AT)

**TABLE 6-9A
EXPOSURE FACTOR ASSUMPTIONS FOR SEAD-59 AND SEAD-71
SEAD-59 AND SEAD-71 PHASE II RI
Seneca Army Depot Activity**

Scenario Timeframe:	Current/Future
Medium:	Soil
Exposure Medium:	Air
Exposure Point:	SEAD-59 and SEAD-71
Receptor Population:	Construction Worker
Receptor Age:	Adult

EXPOSURE ROUTE	PARAMETER CODE	PARAMETER DEFINITION	UNITS	RME VALUE	RME RATIONALE	RME REFERENCE	CT VALUE	CT RATIONALE	CT REFERENCE
Inhalation of Dust in Ambient Air	EPC	Air EPC	mg/m ³		Surface and subsurface soils.	Table 5-7C, 5-8A/B		Surface and subsurface soils.	Table 5-7C, 5-8A/B
	BW	Body Weight	kg	70	Default value for construction worker.	USEPA, 2002.	70	Default value for construction worker.	USEPA, 2002.
	IR	Inhalation Rate	m ³ /day	20	Default value for construction worker.	USEPA, 2002.	20	Default value for construction worker.	USEPA, 2002.
	EF	Exposure Frequency	days/yr	250	Default value for construction worker.	USEPA, 2002.	219	Default value for industrial worker.	USEPA, 2004.
	ED	Exposure Duration	year	1	Default value for construction worker.	USEPA, 2002.	1	Default value for construction worker.	USEPA, 2002.
	AT(Nc) AT(Cair)	Averaging Time - Nc Averaging Time - Car	days days	365 25,550	1 year. 70 years, default value for construction worker.	USEPA, 2002.	365 25,550	1 year. 70 years, default value for construction worker.	USEPA, 2002.

Source References:

- USEPA, 2002: Supplemental Guidance For Developing Soil Screening Levels For Superfund Sites. December.
- USEPA, 2004: Risk Assessment Guidance for Superfund Volume I: Human Health Evaluation Manual (Part E, Supplemental Guidance for Dermal Risk Assessment) Final.

Notes:

RME = Reasonable Maximum Exposure
CT = Central Tendency Exposure

Intake Equation:

Inhalation Daily Intake (DI) (mg/kg-day) = EPC x IR x EF x ED / (BW x AT)

**TABLE 6-9A
EXPOSURE FACTOR ASSUMPTIONS FOR SEAD-59 AND SEAD-71
SEAD-59 AND SEAD-71 PHASE II RI
Seneca Army Depot Activity**

Scenario Timeframe:	Current/Future
Medium:	Groundwater
Exposure Medium:	Groundwater
Exposure Point:	SEAD-59 and SEAD-71
Receptor Population:	Construction Worker
Receptor Age:	Adult

EXPOSURE ROUTE	PARAMETER CODE	PARAMETER DEFINITION	UNITS	RME VALUE	RME RATIONALE	RME REFERENCE	CT VALUE	CT RATIONALE	CT REFERENCE
Intake of Groundwater	EPC	Groundwater EPC	mg/L	70	Table 5-6A/B	Table 5-6A/B	70	Table 5-6A/B	Table 5-6A/B
	BW	Body Weight	kg	70	Default value for construction worker.	USEPA, 2002.	70	Default value for construction worker.	USEPA, 2002.
	IR	Intake Rate	L/day	1	Default intake rate for commercial/industrial worker.	USEPA, 1991.	0.7	Average adult tap water intake is 1.41 L/day, assuming half occurs at work.	USEPA, 1997 & BPJ.
	EF	Exposure Frequency	days/yr	250	Default value for construction worker.	USEPA, 2002.	219	Default value for industrial worker.	USEPA, 2004.
	ED	Exposure Duration	year	1	Default value for construction worker.	USEPA, 2002.	1	Default value for construction worker.	USEPA, 2002.
	AT(Nc) AT(Cair)	Averaging Time - Nc Averaging Time - Car	days days	365 25,550	1 year. 70 years, default value for construction worker.	USEPA, 2002.	365 25,550	1 year. 70 years, default value for construction worker.	USEPA, 2002.
Dermal of Groundwater	EPC	Groundwater EPC	mg/L	70	Table 5-6A/B	Table 5-6A/B	70	Table 5-6A/B	Table 5-6A/B
	BW	Body Weight	kg	70	Default value for construction worker.	USEPA, 2002.	70	Default value for construction worker.	USEPA, 2002.
	SA	Skin Surface Area	cm ²	2490	Maximum surface area for adult male (including hands and forearms).	USEPA, 1997	1980	Average surface area for adult male (including hands and forearms).	USEPA, 1997.
	ED	Exposure Duration	years	1	Default value for construction worker.	USEPA, 2002, 2004.	1	Default value for industrial worker.	USEPA, 2004.
	EF	Exposure Frequency	days/yr	100	Assumes contact with groundwater 2 workdays each week for 50 weeks.	BPJ.	100	Assumes contact with groundwater 2 workdays each week for 50 weeks.	USEPA, 2004.
	EV	Event Frequency	events/day	1	Assumption.	BPJ.	1	Assumption.	BPJ.
	t _{event}	Event duration (hr/event)	hr/event	0.5	Assumes half hour to assemble or disassemble a pumping system.	BPJ.	0.5	Assumes half hour to assemble or disassemble a pumping system.	BPJ.
	AT(Nc) AT(Cair)	Averaging Time - Nc Averaging Time - Car	days days	365 25,550	1 year. 70 years, default value for construction worker.	USEPA, 2002.	365 25,550	1 year. 70 years, default value for construction worker.	USEPA, 2002.

Source References:

- BPJ: Best Professional Judgement.
- USEPA, 1991: Human Health Evaluation Manual. OSWER Directive 9285.6-03. Jun 25.
- USEPA, 1997: Exposure Factors Handbook
- USEPA, 2002: Supplemental Guidance For Developing Soil Screening Levels For Superfund Sites. December.
- USEPA, 2004: Risk Assessment Guidance for Superfund Volume I: Human Health Evaluation Manual (Part E, Supplemental Guidance for Dermal Risk Assessment) Final.

Notes:

RME = Reasonable Maximum Exposure
CT = Central Tendency Exposure

Intake Equation:

Ingestion Daily Intake (DI) (mg/kg-day) = EPC x IR x EF x ED/(BW x AT)
Dermal Dermal Absorbed Dose (DAD) (mg/kg-day) = (DA_{event} x EV x ED x EF x SA) / (BW x AT)

For Inorganics, $DA_{event} = K_p \times EPC \times t_{event}$

For Organics, If $t_{event} \leq t^*$, then: $DA_{event} = 2 FA \times K_p \times EPC \left(\frac{6 \tau_{event} \times t_{event}}{\pi} \right)^{1/2}$

if $t_{event} > t^*$, then: $DA_{event} = FA \times K_p \times EPC \left[\left(\frac{t_{event}}{1+B} \right) + 2 \tau_{event} \left(\frac{1+3B+3B^2}{(1+B)^2} \right) \right]$

Where: $t^* = \text{Time to reach steady-state (hr)}$

$\tau_{event} = \text{Lag Time per event (hr/event)}$

B = Dimensionless ratio of the permeability coefficient of a compound through the stratum corneum relative to its permeability coefficient across the viable epidermis (ve) (dimensionless)
FA = Fraction absorbed water (dimensionless)

TABLE 6-9B
EXPOSURE FACTOR ASSUMPTIONS FOR SEAD-59 AND SEAD-71
SEAD-59 AND SEAD-71 PHASE II RI
Seneca Army Depot Activity

Scenario Timeframe:	Future
Medium:	Soil
Exposure Medium:	Soil
Exposure Point:	SEAD-59 and SEAD-71
Receptor Population:	Industrial Worker
Receptor Age:	Adult

EXPOSURE ROUTE	PARAMETER CODE	PARAMETER DEFINITION	UNITS	RME VALUE	RME RATIONALE	RME REFERENCE	CT VALUE	CT RATIONALE	CT REFERENCE
Ingestion of Soil	EPC	Soil EPC	mg/kg		Surface soils.	Table 5-4A/B/C		Surface soils.	Table 5-4A/B/C
	BW	Body Weight	kg	70	Default value for industrial worker.	USEPA, 2002.	70	Default value for industrial worker.	USEPA, 2002.
	IR	Ingestion Rate	mg/day	100	Default value for outdoor worker.	USEPA, 2002.	50	Mean adult soil ingestion rate.	USEPA, 1997.
	FI	Fraction Ingested	unitless	1	Assuming 100% ingestion from site.	BPJ.	1	Assuming 100% ingestion from site.	BPJ.
	EF	Exposure Frequency	days/yr	250	Default value for industrial worker.	USEPA, 2002, 2004.	219	Default value for industrial worker.	USEPA, 2004.
	ED	Exposure Duration	year	25	Default value for industrial worker.	USEPA, 2002, 2004.	9	Default value for industrial worker.	USEPA, 2004.
	CF	Conversion Factor	kg/mg	1E-6			1E-6		
	AT(Nc) AT(Cair)	Averaging Time - Nc Averaging Time - Car	days days	9,125 25,550	25 years. 70 years, default value for industrial worker.	USEPA, 2002.	3,285 25,550	9 years. 70 years, default value for industrial worker.	USEPA, 2002.
Dermal Contact of Soil	EPC	Soil EPC	mg/kg		Surface soils.	Table 5-4A/B/C		Surface soils.	Table 5-4A/B/C
	BW	Body Weight	kg	70	Default value for industrial worker.	USEPA, 2002.	70	Default value for industrial worker.	USEPA, 2002.
	SA	Skin Contact Surface Area	cm ²	3,300	Default value for industrial worker.	USEPA, 2002, 2004.	3,300	Default value for industrial worker.	USEPA, 2002, 2004.
	AF	Soil/Skin Adherence Factor	mg/cm ² -event	0.2	Default value for adherence factor.	USEPA, 2002, 2004.	0.02	Default value for adherence factor.	USEPA, 2004.
	ABS	Dermal Absorption Fraction	unitless		Chemical-specific	USEPA, 2004.		Chemical-specific	USEPA, 2004.
	EV	Event Frequency	events/day	1	Default value for industrial worker.	USEPA, 2004.	1	Default value for industrial worker.	USEPA, 2002, 2004.
	EF	Exposure Frequency	days/yr	250	Default value for industrial worker.	USEPA, 2002, 2004.	219	Default value for industrial worker.	USEPA, 2004.
	ED	Exposure Duration	year	25	Default value for industrial worker.	USEPA, 2002, 2004.	9	Default value for industrial worker.	USEPA, 2004.
	CF	Conversion Factor	kg/mg	1E-6			1E-6		
	AT(Nc)	Averaging Time - Nc	days	9,125	25 year.		3,285	9 years.	
	AT(Cair)	Averaging Time - Car	days	25,550	70 years, default value for industrial worker.	USEPA, 2002.	25,550	70 years, default value for industrial worker.	USEPA, 2002.

Source References:

- BPJ: Best Professional Judgement.
- USEPA, 1997: Exposure Factors Handbook
- USEPA, 2002: Supplemental Guidance For Developing Soil Screening Levels For Superfund Sites. December.
- USEPA, 2004: Risk Assessment Guidance for Superfund Volume I: Human Health Evaluation Manual (Part E, Supplemental Guidance for Dermal Risk Assessment) Final.

Notes:
RME = Reasonable Maximum Exposure
CT = Central Tendency Exposure

Intake Equations

Ingestion Daily Intake (DI) (mg/kg-day) = EPC x IR x EF x ED x CF x FI / (BW x AT)

Dermal DI (mg/kg-day) = EPC x SA x AF x ABS x EV x EF x ED x CF/(BW x AT)

**TABLE 6-9B
EXPOSURE FACTOR ASSUMPTIONS FOR SEAD-59 AND SEAD-71
SEAD-59 AND SEAD-71 PHASE II RI
Seneca Army Depot Activity**

Scenario Timeframe:	Future
Medium:	Soil
Exposure Medium:	Air
Exposure Point:	SEAD-59 and SEAD-71
Receptor Population:	Industrial Worker
Receptor Age:	Adult

EXPOSURE ROUTE	PARAMETER CODE	PARAMETER DEFINITION	UNITS	RME VALUE	RME RATIONALE	RME REFERENCE	CT VALUE	CT RATIONALE	CT REFERENCE
Inhalation of Dust in Ambient Air	EPC	Air EPC	mg/m ³	70	Surface soils.	Table 5-7A/B/C		Surface soils.	Table 5-7A/B/C
	BW	Body Weight	kg	70	Default value for industrial worker.	USEPA, 2002.	70	Default value for industrial worker.	USEPA, 2002.
	IR	Inhalation Rate	m ³ /day	20	Default value for industrial worker.	USEPA, 2002.	10.4	Assumes average inhalation rate of 1.3 m ³ /hr for outdoor worker for 8 hrs/day.	USEPA, 1997 & BPJ.
	EF	Exposure Frequency	days/yr	250	Default value for industrial worker.	USEPA, 2002, 2004.	219	Default value for industrial worker.	USEPA, 2004.
	ED	Exposure Duration	year	25	Default value for industrial worker.	USEPA, 2002, 2004.	9	Default value for industrial worker.	USEPA, 2004.
	AT(Nc) AT(Cair)	Averaging Time - Nc Averaging Time - Car	days days	9,125 25,550	25 years. 70 years, default value for industrial worker.	USEPA, 2002.	3,285 25,550	9 years. 70 years, default value for industrial worker.	USEPA, 2002.

Source References:

- BPJ: Best Professional Judgement.
- USEPA, 1997: Exposure Factors Handbook
- USEPA, 2002: Supplemental Guidance For Developing Soil Screening Levels For Superfund Sites. December.
- USEPA, 2004: Risk Assessment Guidance for Superfund Volume I: Human Health Evaluation Manual (Part E, Supplemental Guidance for Dermal Risk Assessment) Final.

Notes:
RME = Reasonable Maximum Exposure
CT = Central Tendency Exposure

Intake Equation

Inhalation Daily Intake (DI) (mg/kg-day) = EPC x IR x EF x ED / (BW x AT)

**TABLE 6-9B
EXPOSURE FACTOR ASSUMPTIONS FOR SEAD-59 AND SEAD-71
SEAD-59 AND SEAD-71 PHASE II RI
Seneca Army Depot Activity**

Scenario Timeframe:	Future
Medium:	Groundwater
Exposure Medium:	Groundwater
Exposure Point:	SEAD-59 and SEAD-71
Receptor Population:	Industrial Worker
Receptor Age:	Adult

EXPOSURE ROUTE	PARAMETER CODE	PARAMETER DEFINITION	UNITS	RME VALUE	RME RATIONALE	RME REFERENCE	CT VALUE	CT RATIONALE	CT REFERENCE
Intake of Groundwater	EPC	Groundwater EPC	mg/L		Table 5-6A/B	Table 5-6A/B		Table 5-6A/B	Table 5-6A/B
	BW	Body Weight	kg	70	Default value for industrial worker.	USEPA, 2002.	70	Default value for industrial worker.	USEPA, 2002.
	IR	Intake Rate	L/day	1	Default intake rate for commercial/industrial worker.	USEPA, 1991.	0.7	Average adult tap water intake is 1.41 L/day, assuming half occurs at work.	USEPA, 1997 & BPJ.
	EF	Exposure Frequency	days/yr	250	Default value for industrial worker.	USEPA, 2002, 2004.	219	Default value for industrial worker.	USEPA, 2004.
	ED	Exposure Duration	year	25	Default value for industrial worker.	USEPA, 2002, 2004.	9	Default value for industrial worker.	USEPA, 2004.
	AT(Nc)	Averaging Time - Nc	days	9,125	25 years.		3,285	9 years.	
	AT(Cair)	Averaging Time - Car	days	25,550	70 years, default value for industrial worker.	USEPA, 2002.	25,550	70 years, default value for industrial worker.	USEPA, 2002.

Source References:

- BPJ: Best Professional Judgement.
- USEPA, 1991: Human Health Evaluation Manual. OSWER Directive 9285.6-03. Jun 25.
- USEPA, 1997: Exposure Factors Handbook
- USEPA, 2002: Supplemental Guidance For Developing Soil Screening Levels For Superfund Sites. December.
- USEPA, 2004: Risk Assessment Guidance for Superfund Volume I: Human Health Evaluation Manual (Part E, Supplemental Guidance for Dermal Risk Assessment) Final.

Notes:

RME = Reasonable Maximum Exposure
CT = Central Tendency Exposure

Intake Equation:

Daily Intake (DI) (mg/kg-day) = EPC x IR x EF x ED/(BW x AT)

**TABLE 6-9C
EXPOSURE FACTOR ASSUMPTIONS FOR SEAD-59 AND SEAD-71
SEAD-59 AND SEAD-71 PHASE II RI
Seneca Army Depot Activity**

Scenario Timeframe:	Current/Future
Medium:	Soil
Exposure Medium:	Soil
Exposure Point:	SEAD-59 and SEAD-71
Receptor Population:	Child Trespasser / Child Visitor
Receptor Age:	Child (0-6 yr)

EXPOSURE ROUTE	PARAMETER CODE	PARAMETER DEFINITION	UNITS	RME VALUE	RME RATIONALE	RME REFERENCE	CT VALUE	CT RATIONALE	CT REFERENCE
Ingestion of Soil	EPC	Soil EPC	mg/kg		Surface soils.	Table 5-4A/B/C		Surface soils.	Table 5-4A/B/C
	BW	Body Weight	kg	15	Default value for child (ages 0-6yr).	USEPA, 2002.	15	Default value for child.	USEPA, 2002.
	IR	Ingestion Rate	mg/day	200	Default soil ingestion rate for child.	USEPA, 2002.	100	Mean soil ingestion rate for child.	USEPA, 1997.
	FI	Fraction Ingested	unitless	1	Assuming 100% ingestion from site.	BPJ.	1	Assuming 100% ingestion from site.	BPJ.
	EF	Exposure Frequency	days/yr	14	Assumes 2 weeks.	BPJ.	14	Assumes 2 weeks.	BPJ.
	ED	Exposure Duration	year	6	Default exposure duration.	USEPA, 2002.	6	Default exposure duration.	USEPA, 2002.
	CF	Conversion Factor	kg/mg	1E-6			1E-6		
	AT(Nc) AT(Cair)	Averaging Time - Nc Averaging Time - Car	days days	2,190 25,550	6 years. 70 years, default value for human life span.	USEPA, 2002.	2,190 25,550	6 years. 70 years, default value for human life span.	USEPA, 2002.
Dermal Contact of Soil	EPC	Soil EPC	mg/kg		Surface soils.	Table 5-4A/B/C		Surface soils.	Table 5-4A/B/C
	BW	Body Weight	kg	15	Default value for child.	USEPA, 2002.	15	Default value for child.	USEPA, 2002.
	SA	Skin Contact Surface Area	cm ²	2,800	Default RME value for child.	USEPA, 2004.	2,800	Default CT value for child.	USEPA, 2004.
	AF	Soil/Skin Adherence Factor	mg/cm ² -event	0.2	Default value for child.	USEPA, 2004.	0.04	Default value for child.	USEPA, 2004.
	ABS	Dermal Absorption Fraction	unitless		Chemical-specific	USEPA, 2004.		Chemical-specific	USEPA, 2004.
	EV	Event Frequency	events/day	1	Default value for residential child.	USEPA, 2004.	1	Default value for residential child.	USEPA, 2004.
	EF	Exposure Frequency	days/yr	14	Assumes 2 weeks.	BPJ.	14	Assumes 2 weeks.	BPJ.
	ED	Exposure Duration	year	6	Default exposure duration.	USEPA, 2002.	6	Default exposure duration.	USEPA, 2002.
	CF	Conversion Factor	kg/mg	1E-6			1E-6		
	AT(Nc) AT(Cair)	Averaging Time - Nc Averaging Time - Car	days days	2,190 25,550	6 years. 70 years, default value for human life span.	USEPA, 2002.	2,190 25,550	6 years. 70 years, default value for human life span.	USEPA, 2002.

Notes:
RME = Reasonable Maximum Exposure
CT = Central Tendency Exposure

Source References:
 - BPJ: Best Professional Judgement.
 - USEPA, 1997: Exposure Factors Handbook
 - USEPA, 2002: Supplemental Guidance For Developing Soil Screening Levels For Superfund Sites. December.
 - USEPA, 2004: Risk Assessment Guidance for Superfund Volume I: Human Health Evaluation Manual (Part E, Supplemental Guidance for Dermal Risk Assessment) Final.

Intake Equations:
 Ingestion Daily Intake (DI) (mg/kg-day) = EPC x IR x EF x ED x CF x FI / (BW x AT)
 Dermal DI (mg/kg-day) = EPC x SA x AF x ABS x EV x EF x ED x CF/(BW x AT)

**TABLE 6-9C
EXPOSURE FACTOR ASSUMPTIONS FOR SEAD-59 AND SEAD-71
SEAD-59 AND SEAD-71 PHASE II RI
Seneca Army Depot Activity**

Scenario Timeframe:	Current/Future
Medium:	Soil
Exposure Medium:	Air
Exposure Point:	SEAD-59 and SEAD-71
Receptor Population:	Child Trespasser / Child Visitor
Receptor Age:	Child (0-6 yr)

EXPOSURE ROUTE	PARAMETER CODE	PARAMETER DEFINITION	UNITS	RME VALUE	RME RATIONALE	RME REFERENCE	CT VALUE	CT RATIONALE	CT REFERENCE
Inhalation of Dust in Ambient Air	EPC	Air EPC	mg/m ³	15	Surface soils.	Table 5-7A/B/C		Surface soils.	Table 5-7A/B/C
	BW	Body Weight	kg		Default value for child (ages 0-6yr).	USEPA, 2002.	15	Default value for child ages 0-6yr.	USEPA, 2002.
	IR	Inhalation Rate	m ³ /day	12	Average long term inhalation rate for child ages 0-6 yr is 7.1 m ³ /day (Table 5-23). Assuming 8 hr/day exposure.	USEPA, 1997 & BPJ.	12	Average long term inhalation rate for child ages 0-6 yr is 7.1 m ³ /day (Table 5-23). Assuming 8 hr/day exposure.	USEPA, 1997 & BPJ.
	EF	Exposure Frequency	days/yr	14	Attends 5 days/wk and 10 days/yr vacation.	BPJ.	14	Default value for industrial worker.	USEPA, 2004.
	ED	Exposure Duration	year	6	Default value for exposure duration.	USEPA, 2002.	6	Default value for exposure duration.	USEPA, 2002.
	AT(Nc)	Averaging Time - Nc	days	2,190	6 years.		2,190	6 years.	
	AT(Cair)	Averaging Time - Car	days	25,550	70 years, default value for human life span.	USEPA, 2002.	25,550	70 years, default value for human life span.	USEPA, 2002.

Source References:

- BPJ: Best Professional Judgement.
- USEPA, 1997: Exposure Factors Handbook
- USEPA, 2002: Supplemental Guidance For Developing Soil Screening Levels For Superfund Sites. December.
- USEPA, 2004: Risk Assessment Guidance for Superfund Volume I: Human Health Evaluation Manual (Part E, Supplemental Guidance for Dermal Risk Assessment) Final.

Notes:

RME = Reasonable Maximum Exposure
CT = Central Tendency Exposure

Intake Equation:

Inhalation Daily Intake (DI) (mg/kg-day) = EPC x IR x EF x ED / (BW x AT)

**TABLE 6-9C
EXPOSURE FACTOR ASSUMPTIONS FOR SEAD-59 AND SEAD-71
SEAD-59 AND SEAD-71 PHASE II RI
Seneca Army Depot Activity**

Scenario Timeframe:	Current/Future
Medium:	Groundwater
Exposure Medium:	Groundwater
Exposure Point:	SEAD-59 and SEAD-71
Receptor Population:	Child Trespasser / Child Visitor
Receptor Age:	Child (0-6 yr)

EXPOSURE ROUTE	PARAMETER CODE	PARAMETER DEFINITION	UNITS	RME VALUE	RME RATIONALE	RME REFERENCE	CT VALUE	CT RATIONALE	CT REFERENCE
Intake of Groundwater	EPC	Groundwater EPC	mg/L		Table 5-6A/B	Table 5-6A/B		Table 5-6A/B	Table 5-6A/B
	BW	Body Weight	kg	15	Default value for child (ages 0-6r).	USEPA, 2002.	15	Default value for child ages (0-6yr).	USEPA, 2002.
	IR	Intake Rate	L/day	1.5	95th percentile for children ages 1-10 yr.	USEPA, 1997.	0.74	Average for children ages 1-10 yr.	USEPA, 1997.
	EF	Exposure Frequency	days/yr	14	Assumption.	BPJ	14	Assumption.	BPJ
	ED	Exposure Duration	year	6	Default exposure duration.	USEPA, 2002.	6	Default exposure duration.	USEPA, 2002.
	AT(Nc) AT(Cair)	Averaging Time - Nc Averaging Time - Car	days days	2,190 25,550	6 years. 70 years, default value for human life span.	USEPA, 2002.	2,190 25,550	6 years. 70 years, default value for human life span.	USEPA, 2002.

Source References:

- USEPA, 1997: Exposure Factors Handbook
- USEPA, 2002: Supplemental Guidance For Developing Soil Screening Levels For Superfund Sites. December.
- USEPA, 2004: Risk Assessment Guidance for Superfund Volume I: Human Health Evaluation Manual (Part E, Supplemental Guidance for Dermal Risk Assessment) Final.

Notes:

RME = Reasonable Maximum Exposure
CT = Central Tendency Exposure

Intake Equations:

Intake Daily Intake (DI) (mg/kg-day) = EPC x IR x EF x ED/(BW x AT)

TABLE 6-10
SUSPENDED PARTICULATE CONCENTRATIONS MEASURED AT SEDA
SEAD-59 AND SEAD-71 PHASE II RI
Seneca Army Depot Activity

PARTICULATE DATA	SITE #1 PM 10	SITE #2 PM 10	SITE #3 PM 10	SITE #4 PM 10
Peak Concentration (ug/m3)	37 on 23 July 95	37 on 23 July 95	37 on 5 July 95	37 on 5 July 95
Arithmetic Mean (ug/m3)	16.9	16.6	16.4	15.8
Standard Deviation	21.4	21.1	23.0	23.0
Geometric Mean (ug/m3)	15.1	14.8	14.8	14.2
No. of 24-hr. Avgs. Above 150 ug/m3	0	0	0	0
Number of Valid Samples	29	32	29	31
Percent Data Recovery	90.6	100.0	90.6	96.9

Cumulative Summary for April 1, 1995 through July 31, 1995

**TABLE 6-11A
NON-CANCER TOXICITY DATA -- ORAL/DERMAL
SEAD-59 AND SEAD-71**

Chemical of Potential Concern	Chronic/ Subchronic	Oral RfD Value	Oral RfD Units	Oral to Dermal Adjustment Factor (1)	Adjusted Dermal RfD (2)	Units	Primary Target Organ	Combined Uncertainty/Modifying Factors	Sources of RfD: Target Organ	Dates of RfD: Target Organ (3) (MM/DD/YY)
4-nitroaniline	Chronic	3.00E-03	mg/kg-day	1	3.00E-03	mg/kg-day	N/A	N/A	PPRTV	10/8/2004
Benzo(a)anthracene	N/A	N/A	N/A	1	N/A	N/A	N/A	N/A	N/A	N/A
Benzo(a)pyrene	N/A	N/A	N/A	1	N/A	N/A	N/A	N/A	N/A	N/A
Benzo(b)fluoranthene	N/A	N/A	N/A	1	N/A	N/A	N/A	N/A	N/A	N/A
Benzo(k)fluoranthene	N/A	N/A	N/A	1	N/A	N/A	N/A	N/A	N/A	N/A
Carbazole	N/A	N/A	N/A	1	N/A	N/A	N/A	N/A	N/A	N/A
Chrysene	N/A	N/A	N/A	1	N/A	N/A	N/A	N/A	N/A	N/A
Dibenz(a,h)anthracene	N/A	N/A	N/A	1	N/A	N/A	N/A	N/A	N/A	N/A
Indeno(1,2,3-cd)pyrene	N/A	N/A	N/A	1	N/A	N/A	N/A	N/A	N/A	N/A
4,4'-DDE	N/A	N/A	N/A	1	N/A	N/A	N/A	N/A	N/A	N/A
4,4'-DDT	Chronic	5E-04	mg/kg-day	1	5E-04	mg/kg-day	Liver	100	IRIS	12/03/2004
Heptachlor epoxide	Chronic	1.3E-05	mg/kg-day	1	1.3E-05	mg/kg-day	Liver	1000	IRIS	12/03/2004
Antimony	Chronic	4E-04	mg/kg-day	0.15	6E-05	mg/kg-day	Whole Body Blood	1000	IRIS	12/03/2004
Arsenic	Chronic	3E-04	mg/kg-day	1	3E-04	mg/kg-day	Skin	3	IRIS	12/03/2004
Iron	Chronic	3E-01	mg/kg-day	1	3E-01	mg/kg-day	N/A	1	NCEA	07/23/96
Manganese (4)	Chronic	2.3E-02	mg/kg-day	0.04	9E-04	mg/kg-day	Central Nervous	3	IRIS	12/23/2004
Thallium (5)	Chronic	6E-04	mg/kg-day	1	6E-04	mg/kg-day	Liver, Blood, Hair	3000	IRIS	12/23/2004

N/A = Not Applicable

NCEA = National Center for Environmental Assessment

IRIS = Integrated Risk Information System

PPRTV = EPA's Provisional Peer Reviewed Toxicity Values

(1) Source: Supplemental Guidance for Dermal Risk Assessment, Part E of Risk Assessment Guidance for Superfund, Human Health Evaluation Manual (Volume I). Final. USEPA. 2004.

A default value of 1 was used if no value was available in the USEPA (2004) document.

(2) Dermal RfD = Oral RfD x Adjustment Factor

(3) For IRIS values, the date was the last time IRIS was checked.

For NCEA values, the date was the date of the article provided by NCEA.

For PPRTV values, the date was the date of the Region III RBC table, where the PPRTV was cited from.

(4) The chronic oral RfD for manganese was adjusted by using a modifying factor of 3 in accordance with the IRIS recommendation.

In addition, dietary exposure (assumed 5 mg/day) was subtracted. Thus, the RfD used in this risk assessment is 1/6 of the value listed in the IRIS.

(5) The chronic oral RfD for thallium was based on the chronic oral RfD of thallium sulfate adjusted for molecular weight differences.

**TABLE 6-11B
NON-CANCER TOXICITY DATA -- INHALATION
SEAD-59 AND SEAD-71**

Chemical of Potential Concern	Chronic/ Subchronic	Value Inhalation RfC	Units	Adjusted Inhalation RfD (1)	Units	Primary Target Organ	Combined Uncertainty/Modifyin Factors	Sources of RfC:RfD: Target Organ	Dates (2) (MM/DD/YY)
4-nitroaniline	Chronic	N/A	N/A	1.00E-03	mg/kg-day	N/A	N/A	PPRTV	10/8/2004
Benzo(a)anthracene	N/A	N/A	N/A	N/A	N/A	N/A	N/A	N/A	N/A
Benzo(a)pyrene	N/A	N/A	N/A	N/A	N/A	N/A	N/A	N/A	N/A
Benzo(b)fluoranthene	N/A	N/A	N/A	N/A	N/A	N/A	N/A	N/A	N/A
Benzo(k)fluoranthene	N/A	N/A	N/A	N/A	N/A	N/A	N/A	N/A	N/A
Carbazole	N/A	N/A	N/A	N/A	N/A	N/A	N/A	N/A	N/A
Chrysene	N/A	N/A	N/A	N/A	N/A	N/A	N/A	N/A	N/A
Dibenz(a,h)anthracene	N/A	N/A	N/A	N/A	N/A	N/A	N/A	N/A	N/A
Indeno(1,2,3-cd)pyrene	N/A	N/A	N/A	N/A	N/A	N/A	N/A	N/A	N/A
4,4'-DDE	N/A	N/A	N/A	N/A	N/A	N/A	N/A	N/A	N/A
4,4'-DDT	N/A	N/A	N/A	N/A	N/A	N/A	N/A	N/A	N/A
Heptachlor epoxide	N/A	N/A	N/A	N/A	N/A	N/A	N/A	N/A	N/A
Antimony	N/A	N/A	N/A	N/A	N/A	N/A	N/A	N/A	N/A
Arsenic	N/A	N/A	N/A	N/A	N/A	N/A	N/A	N/A	N/A
Iron	N/A	N/A	N/A	N/A	N/A	N/A	N/A	N/A	N/A
Manganese	Chronic	5E-05	mg/m ³	1E-05	mg/kg-day	Central Nervous System	1000	IRIS	12/23/04
Thallium	N/A	N/A	N/A	N/A	N/A	N/A	N/A	N/A	N/A

Notes:

(1) Inhalation RfD was adjusted based on the assumption of 70 kg body weight and 20 m³/day inhalation rate.

(2) For IRIS values, the date was the last time IRIS was checked.

For PPRTV values, the date was the date of the Region III RBC table, where the PPRTV was cited from.

N/A = Not Applicable

IRIS = Integrated Risk Information System

PPRTV = EPA's Provisional Peer Reviewed Toxicity Values

**TABLE 6-11C
CANCER TOXICITY DATA -- ORAL/DERMAL
SEAD-59 AND SEAD-71**

Chemical of Potential Concern	Oral Cancer Slope Factor	Oral Cancer Slope Factor Source	Oral to Dermal Adjustment Factor (1)	Adjusted Dermal Cancer Slope Factor (2)	Units	Weight of Evidence/ Cancer Guideline Description	Weight of Evidence Source	Date (3) (MM/DD/YY)
4-nitroaniline	2.00E-02	PPRTV	1	2.00E-02	(mg/kg-day) ⁻¹	N/A	N/A	10/8/2004
Benzo(a)anthracene	0.73	NCEA	1	0.73	(mg/kg-day) ⁻¹	B2	IRIS	10/8/2004
Benzo(a)pyrene	7.3	IRIS	1	7.3	(mg/kg-day) ⁻¹	B2	IRIS	12/03/2004
Benzo(b)fluoranthene	0.73	NCEA	1	0.73	(mg/kg-day) ⁻¹	B2	IRIS	10/8/2004
Benzo(k)fluoranthene	0.073	NCEA	1	0.073	(mg/kg-day) ⁻¹	B2	IRIS	10/8/2004
Carbazole	0.02	HEAST, 1997	1	0.02	(mg/kg-day) ⁻¹	N/A	N/A	N/A
Chrysene	0.0073	NCEA	1	0.0073	(mg/kg-day) ⁻¹	B2	IRIS	10/8/2004
Dibenz(a,h)anthracene	7.3	NCEA	1	7.3	(mg/kg-day) ⁻¹	B2	IRIS	10/8/2004
Indeno(1,2,3-cd)pyrene	0.73	NCEA	1	0.73	(mg/kg-day) ⁻¹	B2	IRIS	10/8/2004
4,4'-DDE	0.34	IRIS	1	0.34	(mg/kg-day) ⁻¹	B2	IRIS	12/03/2004
4,4'-DDT	0.34	IRIS	1	0.34	(mg/kg-day) ⁻¹	B2	IRIS	12/03/2004
Heptachlor epoxide	9.1	IRIS	1	9.1	(mg/kg-day) ⁻¹	B2	IRIS	12/03/2004
Antimony	N/A	N/A	0.15	N/A	N/A	N/A	N/A	N/A
Arsenic	1.5	IRIS	1	1.5	(mg/kg-day) ⁻¹	A	IRIS	12/03/2004
Iron	N/A	N/A	1	N/A	N/A	N/A	N/A	N/A
Manganese	N/A	N/A	0.04	N/A	N/A	D	N/A	N/A
Thallium	N/A	N/A	1	N/A	N/A	D	N/A	N/A

IRIS = Integrated Risk Information System

HEAST= Health Effects Assessment Summary Tables

NCEA = National Center for Environmental Assessment

PPRTV = EPA's Provisional Peer Reviewed Toxicity Values

EPA Group:

A - Human carcinogen

B1 - Probable human carcinogen - indicates that limited human data are available

B2 - Probable human carcinogen - indicates sufficient evidence in animals and inadequate or no evidence in humans

C - Possible human carcinogen

D - Not classifiable as a human carcinogen

E - Evidence of noncarcinogenicity

Notes:

(1) Source: USEPA (2004) Supplemental Guidance for Dermal Risk Assessment. Part E of Risk Assessment Guidance for Superfund, Human Health Evaluation Manual (Volume I). Final. A default value of 1 was used if no value was available in the USEPA (2004) document.

(2) Dermal Cancer Slope Factor = Oral Cancer Slope Factor/Adjustment Factor

(3) For IRIS values, the date was the last time IRIS was checked.

For PPRTV and NCEA values, the date was the date of the Region III RBC table, where the PPRTV and NCEA values were cited from.

**TABLE 6 -11D
CANCER TOXICITY DATA -- INHALATION
SEAD-59 AND SEAD-71**

Chemical of Potential Concern	Unit Risk	Units	Unit Risk Source	Adjustment (1)	Inhalation Cancer Slope Factor	Units	Weight of Evidence/ Cancer Guideline Description	Weight of Evidence Source	Date (2) (MM/DD/YY)
4-nitroaniline	N/A	N/A	N/A	N/A	N/A	N/A	N/A	N/A	N/A
Benzo(a)anthracene	N/A	N/A	N/A	N/A	N/A	N/A	B2	IRIS	12/03/2004
Benzo(a)pyrene	8.9E-04	(ug/m ³) ⁻¹	NCEA	3500	3.1	(mg/kg-day) ⁻¹	B2	IRIS	10/8/2004
Benzo(b)fluoranthene	N/A	N/A	N/A	N/A	N/A	N/A	B2	IRIS	12/03/2004
Benzo(k)fluoranthene	N/A	N/A	N/A	N/A	N/A	N/A	B2	IRIS	12/03/2004
Carbazole	N/A	N/A	N/A	N/A	N/A	N/A	N/A	N/A	N/A
Chrysene	N/A	N/A	N/A	N/A	N/A	N/A	B2	IRIS	12/03/2004
Dibenz(a,h)anthracene	N/A	N/A	N/A	N/A	N/A	N/A	B2	IRIS	12/03/2004
Indeno(1,2,3-cd)pyrene	N/A	N/A	N/A	N/A	N/A	N/A	B2	IRIS	12/03/2004
4,4'-DDE	N/A	N/A	N/A	N/A	N/A	N/A	B2	IRIS	12/03/2004
4,4'-DDT	9.7E-05	(ug/m ³) ⁻¹	IRIS	3500	3.4E-01	(mg/kg-day) ⁻¹	B2	IRIS	12/03/2004
Heptachlor epoxide	2.6E-03	(ug/m ³) ⁻¹	IRIS	3500	9.1E+00	(mg/kg-day) ⁻¹	B2	IRIS	12/03/2004
Antimony	N/A	N/A	N/A	N/A	N/A	N/A	N/A	N/A	N/A
Arsenic	4.3E-03	(ug/m ³) ⁻¹	IRIS	3500	1.5E+01	(mg/kg-day) ⁻¹	A	IRIS	12/03/2004
Iron	N/A	N/A	N/A	N/A	N/A	N/A	N/A	N/A	N/A
Manganese	N/A	N/A	N/A	N/A	N/A	N/A	D	IRIS	12/23/2004
Thallium	N/A	N/A	N/A	N/A	N/A	N/A	D	IRIS	12/23/2004

IRIS = Integrated Risk Information System
HEAST= Health Effects Assessment Summary Tables
NCEA = National Center for Environmental Assessment

EPA Group:
A - Human carcinogen
B1 - Probable human carcinogen - indicates that limited human data are available
B2 - Probable human carcinogen - indicates sufficient evidence in animals and inadequate or no evidence in humans
C - Possible human carcinogen
D - Not classifiable as a human carcinogen
E - Evidence of noncarcinogenicity

Notes:

(1) The adjustment was based on an assumption of 70 kg body weight and 20 m³/day inhalation rate.

(2) For IRIS values, the date was the last time IRIS was checked.

For NCEA values, the date was the date of the Region III RBC, where the NCEA was cited from.

TABLE 6-12A
 CALCULATION OF TOTAL NON-CARCINOGENIC AND CARCINOGENIC RISKS - SEAD-59
 REASONABLE MAXIMUM EXPOSURE (RME) AND CENTRAL TENDENCY (CT)
 SEAD-59 AND SEAD-71 PHASE II RI
 Seneca Army Depot Activity

RECEPTOR	EXPOSURE ROUTE	REASONABLE MAXIMUM EXPOSURE (RME)				CENTRAL TENDENCY (CT)			
		HAZARD INDEX		CANCER RISK		HAZARD INDEX		CANCER RISK	
		Hazard Index	Percent Contribution	Cancer Risk	Percent Contribution	Hazard Index	Percent Contribution	Cancer Risk	Percent Contribution
<u>INDUSTRIAL WORKER</u>	Inhalation of Dust in Ambient Air	NQ	0%	1E-07	1%	NQ	0%	2E-08	1%
	Ingestion of Soil	1E-01	49%	5E-06	23%	5E-02	41%	7E-07	23%
	Dermal Contact to Soil	6E-03	2%	5E-06	26%	5E-04	0%	2E-07	5%
	Intake of Groundwater	1E-01	49%	1E-05	51%	8E-02	58%	2E-06	72%
	<i>TOTAL RECEPTOR RISK (Nc & Car)</i>	<u>3E-01</u>	100%	<u>2E-05</u>	100%	<u>1E-01</u>	100%	<u>3E-06</u>	100%
<u>CONSTRUCTION WORKER</u>	Inhalation of Dust in Ambient Air	NQ	0%	2E-07	15%	NQ	0%	2E-07	23%
	Ingestion of Soil	4E-01	75%	6E-07	38%	1E-01	56%	2E-07	18%
	Dermal Contact to Soil	8E-03	2%	3E-07	20%	7E-03	4%	3E-07	31%
	Dermal Contact to Groundwater	6E-05	0%	2E-10	0%	5E-05	0%	2E-10	0%
	Intake of Groundwater	1E-01	23%	4E-07	26%	8E-02	40%	3E-07	28%
<i>TOTAL RECEPTOR RISK (Nc & Car)</i>	<u>5E-01</u>	100%	<u>2E-06</u>	100%	<u>2E-01</u>	100%	<u>9E-07</u>	100%	
<u>CHILD TRESPASSER</u>	Inhalation of Dust in Ambient Air	NQ	0%	4E-09	0%	NQ	0%	4E-09	0%
	Ingestion of Soil	6E-02	56%	6E-07	31%	3E-02	57%	3E-07	35%
	Dermal Contact to Soil	1E-03	1%	3E-07	15%	3E-04	0%	6E-08	7%
	Intake of Groundwater	5E-02	43%	1E-06	53%	2E-02	43%	5E-07	58%
	<i>TOTAL RECEPTOR RISK (Nc & Car)</i>	<u>1E-01</u>	100%	<u>2E-06</u>	100%	<u>6E-02</u>	100%	<u>8E-07</u>	100%

NQ= Not Quantified due to lack of toxicity data.

TABLE 6-12B
 CALCULATION OF TOTAL NON-CARCINOGENIC AND CARCINOGENIC RISKS - SEAD-71
 REASONABLE MAXIMUM EXPOSURE (RME) AND CENTRAL TENDENCY (CT)
 SEAD-59 AND SEAD-71 PHASE II RI
 Seneca Army Depot Activity

RECEPTOR	EXPOSURE ROUTE	REASONABLE MAXIMUM EXPOSURE (RME)				CENTRAL TENDENCY (CT)			
		HAZARD INDEX		CANCER RISK		HAZARD INDEX		CANCER RISK	
		Hazard Index	Percent Contribution	Cancer Risk	Percent Contribution	Hazard Index	Percent Contribution	Cancer Risk	Percent Contribution
<u>INDUSTRIAL WORKER</u>	Inhalation of Dust in Ambient Air	NQ	0%	2E-07	0%	NQ	0%	4E-08	0%
	Ingestion of Soil	1E-01	4%	4E-05	24%	5E-02	3%	6E-06	48%
	Dermal Contact to Soil	6E-03	0%	1E-04	66%	5E-04	0%	3E-06	26%
	Intake of Groundwater	2E+00	96%	1E-05	9%	1E+00	97%	3E-06	25%
	<i>TOTAL RECEPTOR RISK (Nc & Car)</i>	<i>3E+00</i>	<i>100%</i>	<i>2E-04</i>	<i>100%</i>	<i>2E+00</i>	<i>100%</i>	<i>1E-05</i>	<i>100%</i>
<u>CONSTRUCTION WORKER</u>	Inhalation of Dust in Ambient Air	NQ	0%	5E-07	4%	NQ	0%	4E-07	6%
	Ingestion of Soil	3E-01	12%	5E-06	41%	9E-02	6%	1E-06	18%
	Dermal Contact to Soil	8E-03	0%	6E-06	50%	7E-03	0%	5E-06	71%
	Dermal Contact to Groundwater	1E-03	0%	4E-10	0%	1E-03	0%	3E-10	0%
	Intake of Groundwater	2E+00	88%	6E-07	5%	1E+00	94%	4E-07	5%
<i>TOTAL RECEPTOR RISK (Nc & Car)</i>	<i>3E+00</i>	<i>100%</i>	<i>1E-05</i>	<i>100%</i>	<i>2E+00</i>	<i>100%</i>	<i>7E-06</i>	<i>100%</i>	
<u>CHILD TRESPASSER</u>	Inhalation of Dust in Ambient Air	NQ	0%	9E-09	0%	NQ	0%	9E-09	0%
	Ingestion of Soil	5E-02	5%	5E-06	41%	3E-02	5%	2E-06	58%
	Dermal Contact to Soil	1E-03	0%	6E-06	47%	3E-04	0%	1E-06	26%
	Intake of Groundwater	9E-01	95%	1E-06	11%	5E-01	95%	7E-07	16%
	<i>TOTAL RECEPTOR RISK (Nc & Car)</i>	<i>1E+00</i>	<i>100%</i>	<i>1E-05</i>	<i>100%</i>	<i>5E-01</i>	<i>100%</i>	<i>4E-06</i>	<i>100%</i>

NQ= Not Quantified due to lack of toxicity data.

TABLE 6-12C
 CALCULATION OF TOTAL NON-CARCINOGENIC AND CARCINOGENIC RISKS - SEAD-59 STOCKPILE SOIL
 REASONABLE MAXIMUM EXPOSURE (RME) AND CENTRAL TENDENCY (CT)
 SEAD-59 AND SEAD-71 PHASE II RI
 Seneca Army Depot Activity

RECEPTOR	EXPOSURE ROUTE	REASONABLE MAXIMUM EXPOSURE (RME)				CENTRAL TENDENCY (CT)			
		HAZARD INDEX		CANCER RISK		HAZARD INDEX		CANCER RISK	
		Hazard Index	Percent Contribution	Cancer Risk	Percent Contribution	Hazard Index	Percent Contribution	Cancer Risk	Percent Contribution
<u>INDUSTRIAL WORKER</u>	Inhalation of Dust in Ambient Air	NQ	0%	1E-07	0%	NQ	0%	2E-08	0%
	Ingestion of Soil	1E-01	44%	1E-05	23%	4E-02	36%	2E-06	35%
	Dermal Contact to Soil	4E-03	2%	2E-05	53%	4E-04	0%	8E-07	16%
	Intake of Groundwater	1E-01	54%	1E-05	23%	8E-02	63%	2E-06	49%
	<i>TOTAL RECEPTOR RISK (Nc & Car)</i>	<u>2E-01</u>	100%	<u>5E-05</u>	100%	<u>1E-01</u>	100%	<u>5E-06</u>	100%
<u>CONSTRUCTION WORKER</u>	Inhalation of Dust in Ambient Air	NQ	0%	5E-09	0%	NQ	0%	4E-09	0%
	Ingestion of Soil	3E-01	72%	1E-06	43%	9E-02	52%	4E-07	19%
	Dermal Contact to Soil	7E-03	1%	1E-06	44%	6E-03	3%	1E-06	67%
	Dermal Contact to Groundwater	6E-05	0%	2E-10	0%	5E-05	0%	2E-10	0%
	Intake of Groundwater	1E-01	27%	4E-07	13%	8E-02	45%	3E-07	14%
<i>TOTAL RECEPTOR RISK (Nc & Car)</i>	<u>5E-01</u>	100%	<u>3E-06</u>	100%	<u>2E-01</u>	100%	<u>2E-06</u>	100%	
<u>CHILD TRESPASSER</u>	Inhalation of Dust in Ambient Air	NQ	0%	4E-09	0%	NQ	0%	4E-09	0%
	Ingestion of Soil	5E-02	51%	1E-06	37%	3E-02	52%	7E-07	47%
	Dermal Contact to Soil	1E-03	1%	1E-06	36%	2E-04	0%	3E-07	18%
	Intake of Groundwater	5E-02	48%	1E-06	28%	2E-02	48%	5E-07	35%
	<i>TOTAL RECEPTOR RISK (Nc & Car)</i>	<u>1E-01</u>	100%	<u>4E-06</u>	100%	<u>5E-02</u>	100%	<u>1E-06</u>	100%

NQ= Not Quantified due to lack of toxicity data.

TABLE 6-12D
 CALCULATION OF TOTAL NON-CARCINOGENIC AND CARCINOGENIC RISKS - SEAD-71 (FENCED AREA EXCLUDED)
 REASONABLE MAXIMUM EXPOSURE (RME) AND CENTRAL TENDENCY (CT)
 SEAD-59 AND SEAD-71 PHASE II RI
 Seneca Army Depot Activity

RECEPTOR	EXPOSURE ROUTE	REASONABLE MAXIMUM EXPOSURE (RME)				CENTRAL TENDENCY (CT)			
		HAZARD INDEX		CANCER RISK		HAZARD INDEX		CANCER RISK	
		Hazard Index	Percent Contribution	Cancer Risk	Percent Contribution	Hazard Index	Percent Contribution	Cancer Risk	Percent Contribution
<u>INDUSTRIAL WORKER</u>	Inhalation of Dust in Ambient Air	NQ	0%	1E-07	0%	NQ	0%	2E-08	0%
	Ingestion of Soil	1E-01	4%	6E-06	21%	4E-02	3%	1E-06	22%
	Dermal Contact to Soil	5E-03	0%	1E-05	31%	4E-04	0%	3E-07	7%
	Intake of Groundwater	2E+00	96%	1E-05	48%	1E+00	97%	3E-06	71%
	<i>TOTAL RECEPTOR RISK (Nc & Car)</i>	<u>3E+00</u>	100%	<u>3E-05</u>	100%	<u>2E+00</u>	100%	<u>5E-06</u>	100%
<u>CONSTRUCTION WORKER</u>	Inhalation of Dust in Ambient Air	NQ	0%	3E-07	10%	NQ	0%	2E-07	15%
	Ingestion of Soil	3E-01	12%	1E-06	37%	9E-02	5%	3E-07	17%
	Dermal Contact to Soil	7E-03	0%	9E-07	31%	6E-03	0%	8E-07	46%
	Dermal Contact to Groundwater	1E-03	0%	3E-10	0%	9E-04	0%	2E-10	0%
	Intake of Groundwater	2E+00	88%	6E-07	21%	1E+00	94%	4E-07	22%
<i>TOTAL RECEPTOR RISK (Nc & Car)</i>	<u>3E+00</u>	100%	<u>3E-06</u>	100%	<u>2E+00</u>	100%	<u>2E-06</u>	100%	
<u>CHILD TRESPASSER</u>	Inhalation of Dust in Ambient Air	NQ	0%	5E-09	0%	NQ	0%	5E-09	0%
	Ingestion of Soil	5E-02	5%	8E-07	29%	3E-02	5%	4E-07	33%
	Dermal Contact to Soil	1E-03	0%	5E-07	19%	2E-04	0%	1E-07	9%
	Intake of Groundwater	9E-01	95%	1E-06	52%	5E-01	95%	7E-07	58%
	<i>TOTAL RECEPTOR RISK (Nc & Car)</i>	<u>1E+00</u>	100%	<u>3E-06</u>	100%	<u>5E-01</u>	100%	<u>1E-06</u>	100%

NQ= Not Quantified due to lack of toxicity data.

TABLE 6-13A
TOTAL NON-CARCINOGENIC AND CARCINOGENIC RISKS FOR UNCERTAINTY ANALYSIS - SEAD-59
REASONABLE MAXIMUM EXPOSURE (RME)
SEAD-59 AND SEAD-71 PHASE II RI
Seneca Army Depot Activity

RECEPTOR	EXPOSURE ROUTE	REASONABLE MAXIMUM EXPOSURE (RME)			
		HAZARD INDEX		CANCER RISK	
		Hazard Index	Percent Contribution	Cancer Risk	Percent Contribution
<u>INDUSTRIAL WORKER</u>	Inhalation of Dust in Ambient Air	1E-01	11%	1E-07	0%
	Ingestion of Soil	2E-01	15%	8E-06	35%
	Dermal Contact to Soil	1E-02	1%	5E-06	22%
	Intake of Groundwater	8E-01	72%	1E-05	43%
	<i>TOTAL RECEPTOR RISK (Nc & Car)</i>	<u>1E+00</u>	100%	<u>2E-05</u>	100%
<u>CONSTRUCTION WORKER</u>	Inhalation of Dust in Ambient Air	7E+00	84%	2E-07	11%
	Ingestion of Soil	6E-01	6%	1E-06	53%
	Dermal Contact to Soil	2E-02	0%	3E-07	15%
	Dermal Contact to Groundwater	4E-04	0%	2E-10	0%
	Intake of Groundwater	8E-01	9%	4E-07	20%
<i>TOTAL RECEPTOR RISK (Nc & Car)</i>	<u>9E+00</u>	100%	<u>2E-06</u>	100%	
<u>ADOLESCENT TRESPASSER</u> <u>(Ages 11-16 yr)</u>	Inhalation of Dust in Ambient Air	8E-04	1%	1E-10	0%
	Ingestion of Soil	1E-02	9%	1E-07	26%
	Dermal Contact to Soil	7E-04	0%	5E-08	10%
	Intake of Groundwater	1E-01	90%	3E-07	64%
	<i>TOTAL RECEPTOR RISK (Nc & Car)</i>	<u>1E-01</u>	100%	<u>5E-07</u>	100%

TABLE 6-13B
TOTAL NON-CARCINOGENIC AND CARCINOGENIC RISKS FOR UNCERTAINTY ANALYSIS - SEAD-59 STOCKPILES
REASONABLE MAXIMUM EXPOSURE (RME)
SEAD-59 AND SEAD-71 PHASE II RI
Seneca Army Depot Activity

RECEPTOR	EXPOSURE ROUTE	REASONABLE MAXIMUM EXPOSURE (RME)			
		HAZARD INDEX		CANCER RISK	
		Hazard Index	Percent Contribution	Cancer Risk	Percent Contribution
<u>INDUSTRIAL WORKER</u>	Inhalation of Dust in Ambient Air	1E-01	12%	1E-07	0%
	Ingestion of Soil	2E-01	13%	3E-05	46%
	Dermal Contact to Soil	1E-02	1%	2E-05	37%
	Intake of Groundwater	8E-01	73%	1E-05	16%
	<i>TOTAL RECEPTOR RISK (Nc & Car)</i>	<u>1E+00</u>	100%	<u>6E-05</u>	100%
<u>CONSTRUCTION WORKER</u>	Inhalation of Dust in Ambient Air	1E-01	9%	5E-09	0%
	Ingestion of Soil	5E-01	33%	4E-06	68%
	Dermal Contact to Soil	2E-02	1%	1E-06	25%
	Dermal Contact to Groundwater	4E-04	0%	2E-10	0%
	Intake of Groundwater	8E-01	56%	4E-07	7%
<i>TOTAL RECEPTOR RISK (Nc & Car)</i>	<u>2E+00</u>	100%	<u>6E-06</u>	100%	
<u>ADOLESCENT TRESPASSER</u> <u>(Ages 11-16 yr)</u>	Inhalation of Dust in Ambient Air	9E-04	1%	1E-10	0%
	Ingestion of Soil	1E-02	8%	5E-07	45%
	Dermal Contact to Soil	6E-04	0%	2E-07	23%
	Intake of Groundwater	1E-01	91%	3E-07	32%
	<i>TOTAL RECEPTOR RISK (Nc & Car)</i>	<u>1E-01</u>	100%	<u>1E-06</u>	100%

TABLE 6-13C
TOTAL NON-CARCINOGENIC AND CARCINOGENIC RISKS FOR UNCERTAINTY ANALYSIS - SEAD-71 (FENCED AREA EXCLUDED)
REASONABLE MAXIMUM EXPOSURE (RME)
SEAD-59 AND SEAD-71 PHASE II RI
Seneca Army Depot Activity

RECEPTOR	EXPOSURE ROUTE	REASONABLE MAXIMUM EXPOSURE (RME)			
		HAZARD INDEX		CANCER RISK	
		Hazard Index	Percent Contribution	Cancer Risk	Percent Contribution
<u>INDUSTRIAL WORKER</u>	Inhalation of Dust in Ambient Air	2E-01	5%	1E-07	0%
	Ingestion of Soil	2E-01	5%	1E-05	36%
	Dermal Contact to Soil	1E-02	0%	1E-05	25%
	Intake of Groundwater	3E+00	91%	1E-05	39%
	<i>TOTAL RECEPTOR RISK (Nc & Car)</i>	<u>3E+00</u>	100%	<u>4E-05</u>	100%
<u>CONSTRUCTION WORKER</u>	Inhalation of Dust in Ambient Air	9E+00	68%	3E-07	6%
	Ingestion of Soil	5E-01	4%	3E-06	60%
	Dermal Contact to Soil	2E-02	0%	9E-07	20%
	Dermal Contact to Groundwater	4E-01	4%	7E-10	0%
	Intake of Groundwater	3E+00	25%	6E-07	14%
<i>TOTAL RECEPTOR RISK (Nc & Car)</i>	<u>1E+01</u>	100%	<u>4E-06</u>	100%	
<u>ADOLESCENT TRESPASSER</u> <u>(Ages 11-16 yr)</u>	Inhalation of Dust in Ambient Air	1E-03	0%	2E-10	0%
	Ingestion of Soil	1E-02	2%	2E-07	28%
	Dermal Contact to Soil	7E-04	0%	9E-08	12%
	Intake of Groundwater	5E-01	97%	5E-07	60%
	<i>TOTAL RECEPTOR RISK (Nc & Car)</i>	<u>5E-01</u>	100%	<u>8E-07</u>	100%

TABLE 6-14
Comparison of Site Aluminum and Manganese Concentrations with Background
SEAD-59 and SEAD-71 Phase II RI
Seneca Army Depot Activity

Preliminary COC	SEAD-59 Surface and Subsurface Soil Concentration (mg/kg)			SEAD-71 Surface and Subsurface Soil Outside Fenced Area Concentration (mg/kg)			Seneca Background (mg/kg)		
	Maximum	Average	95% UCL ¹	Maximum	Average	95% UCL ¹	Maximum	Average	95% UCL ²
Aluminum	18,300	10,895	10,900	15,900	11,493	12,150	20,500	13,206	14,315
Manganese	1,290	503	462	1,330	570	539	2,380	609	701

1. 95% UCL calculated in accordance with the ProUCL Version 3.0 User Guide (USEPA, 2004c).

2. Based on normal distribution.

TABLE 6-15
TOTAL NON-CARCINOGENIC AND CARCINOGENIC RISKS FOR ADOLESCENT TRESPASSER - UNCERTAINTY ANALYSIS
REASONABLE MAXIMUM EXPOSURE (RME)
SEAD-59 AND SEAD-71 PHASE II RI
Seneca Army Depot Activity

Site	EXPOSURE ROUTE	REASONABLE MAXIMUM EXPOSURE (RME)			
		HAZARD INDEX		CANCER RISK	
		Hazard Index	Percent Contribution	Cancer Risk	Percent Contribution
<u>SEAD-59</u>	Inhalation of Dust in Ambient Air	3E-03	1%	5E-10	0%
	Ingestion of Soil	5E-02	9%	5E-07	26%
	Dermal Contact to Soil	2E-03	0%	2E-07	10%
	Intake of Groundwater	5E-01	90%	1E-06	64%
	<i>TOTAL RECEPTOR RISK (Nc & Car)</i>	<u>5E-01</u>	100%	<u>2E-06</u>	100%
<u>SEAD-59 Stockpile</u>	Inhalation of Dust in Ambient Air	3E-03	1%	5E-10	0%
	Ingestion of Soil	4E-02	8%	2E-06	45%
	Dermal Contact to Soil	2E-03	0%	8E-07	23%
	Intake of Groundwater	5E-01	91%	1E-06	32%
	<i>TOTAL RECEPTOR RISK (Nc & Car)</i>	<u>5E-01</u>	100%	<u>4E-06</u>	100%
<u>SEAD-71 Outside Fenced Area</u>	Inhalation of Dust in Ambient Air	3E-03	0%	5E-10	0%
	Ingestion of Soil	4E-02	2%	8E-07	28%
	Dermal Contact to Soil	2E-03	0%	3E-07	12%
	Intake of Groundwater	2E+00	97%	2E-06	60%
	<i>TOTAL RECEPTOR RISK (Nc & Car)</i>	<u>2E+00</u>	100%	<u>3E-06</u>	100%

A 50 days/year exposure frequency was assumed for the adolescent trespasser (11-16 yr).

TABLE 6-16
TOTAL NON-CARCINOGENIC AND CARCINOGENIC RISKS ASSOCIATED WITH SEAD-59 STOCKPILES FOR FUTURE RESIDENTIAL USE SCENARIO
Reasonable Maximum Exposure (RME) and Central Tendency
SEAD-59 and SEAD-71 Phase II RI
Seneca Army Depot Activity

RECEPTOR	EXPOSURE ROUTE	RME				CT			
		HAZARD INDEX		CANCER RISK		HAZARD INDEX		CANCER RISK	
		Hazard Index	Percent Contribution	Cancer Risk	Percent Contribution	Hazard Index	Percent Contribution	Cancer Risk	Percent Contribution
<u>RESIDENT (ADULT)</u>	Inhalation of Dust in Ambient Air	2E-01	8%	2E-07	0%	1E-01	8%	4E-08	0%
	Ingestion of Soil	2E-01	9%	4E-05	46%	1E-01	7%	8E-06	47%
	Dermal Contact to Soil	1E-02	0%	2E-05	22%	2E-03	0%	1E-06	6%
	Intake of Groundwater	2E+00	75%	3E-05	32%	1E+00	80%	7E-06	46%
	Dermal Contact with Groundwater	2E-01	7%	1E-07	0%	7E-02	5%	2E-08	0%
	Inhalation of Groundwater	NQ ¹		NQ ¹		NQ ¹		NQ ¹	
TOTAL RECEPTOR RISK (Nc & Car)		2E+00	100%	9E-05	100%	2E+00	100%	2E-05	100%
<u>RESIDENT (CHILD)</u>	Inhalation of Dust in Ambient Air	3E-01	4%	6E-08	0%	3E-01	7%	6E-08	0%
	Ingestion of Soil	2E+00	22%	9E-05	62%	1E+00	22%	5E-05	72%
	Dermal Contact to Soil	7E-02	1%	3E-05	21%	1E-02	0%	6E-06	10%
	Ingestion of Groundwater	6E+00	68%	2E-05	16%	3E+00	67%	1E-05	19%
	Dermal Contact with Groundwater	5E-01	6%	1E-07	0%	2E-01	4%	4E-08	0%
	Intake of Groundwater	NQ ¹		NQ ¹		NQ ¹		NQ ¹	
TOTAL RECEPTOR RISK (Nc & Car)		9E+00	100%	2E-04	100%	5E+00	100%	7E-05	100%
<u>RESIDENT (TOTAL)</u>	Inhalation of Dust in Ambient Air			2E-07	0%			1E-07	0%
	Ingestion of Soil			1E-04	56%			5E-05	67%
	Dermal Contact to Soil			5E-05	22%			7E-06	9%
	Intake of Groundwater			5E-05	22%			2E-05	24%
	Dermal Contact with Groundwater			3E-07	0%			6E-08	0%
	Inhalation of Groundwater			NQ ¹				NQ ¹	
TOTAL RECEPTOR RISK (Nc & Car)				2E-04	100%			8E-05	100%

Note:

1. All COPCs identified in groundwater are metals; therefore, inhalation of groundwater exposure pathway was assumed negligible and not quantitatively evaluated.

Table 7-1
Policy Goals, Ecological Assessment And Measurement Endpoints, And Decision Rules
SEAD-59 and SEAD-71 Phase II RI Report

Policy Goals	Assessment Endpoint	Measurement Endpoint	Decision Rule
<p>Policy Goal: The protection of ecological species in undeveloped areas capable of sustaining wildlife populations in the vicinity of the sites.</p>	<p>Assessment Endpoint: Survival and reproduction of terrestrial populations in the area of the sites. Three mammalian receptors (deer mouse, short-tailed shrew, and red fox) and one avian receptor (American robin) were selected to represent terrestrial populations at the sites.</p>	<p>Measurement Endpoint: Chronic no-observed-adverse-effect-level (NOAEL) of COPCs on survival and reproduction of identified receptors.</p>	<p>Decision Rule for Assessment Endpoint: If ratios of estimated exposure concentrations predicted from COPC EPCs in soil to NOAEL toxicity reference values for adverse effects on identified receptors (HQs) are <1, then Assessment Endpoint is met and ecological species are not at risk. If ratios are > 1, the COPC is retained as a preliminary COC for further evaluation in the uncertainty section. Final COCs are recommended based on an evaluation of the available weight of evidence.</p>

COPC = Constituent of potential concern
COC = Constituent of concern
EPC = Exposure point concentration
HQ = Hazard quotient
NOAEL = No observed adverse effect level

Table 7-2A
INDEX OF SUBSURFACE SOIL SAMPLES (2-4 ft.)
SEAD-59
SEAD-59 and SEAD-71 Phase II RI Report
Seneca Army Depot Activity

List of SEAD-59 Soil Samples between 2-4 feet bgs

<u>Location ID</u>	<u>Sample ID</u>
MW59-4	59055
SB59-1	SB59-1-06
SB59-11	59132
SB59-15	59061
SB59-17	59068/59131*
SB59-18	59127
SB59-2	SB59-2-04
SB59-21	59067
SB59-5	SB59-5-06
SB59-8	59057
SB59-9	59059
SB59-9	59085/59089*
TP59-11A-2	59026
TP59-13A-1	59010
TP59-13C-1	59015
TP59-15-5	59035
TP59-16-1	59036
TP59-5	TP59-5
TP59-8-2	59050

* - Indicates sample duplicate pair

Table 7-2B
INDEX OF SUBSURFACE SOIL SAMPLES (2-4 ft.)
SEAD-71
SEAD-59 and SEAD-71 Phase II RI Report
Seneca Army Depot Activity

List of SEAD-71 Soil Samples between 2-4 feet bgs

<u>Location ID</u>	<u>Sample ID</u>
TP71-1	TP71-1-1
TP71-1	TP71-1-2
TP71-1	TP71-1-3
TP71-1	TP71-1-4

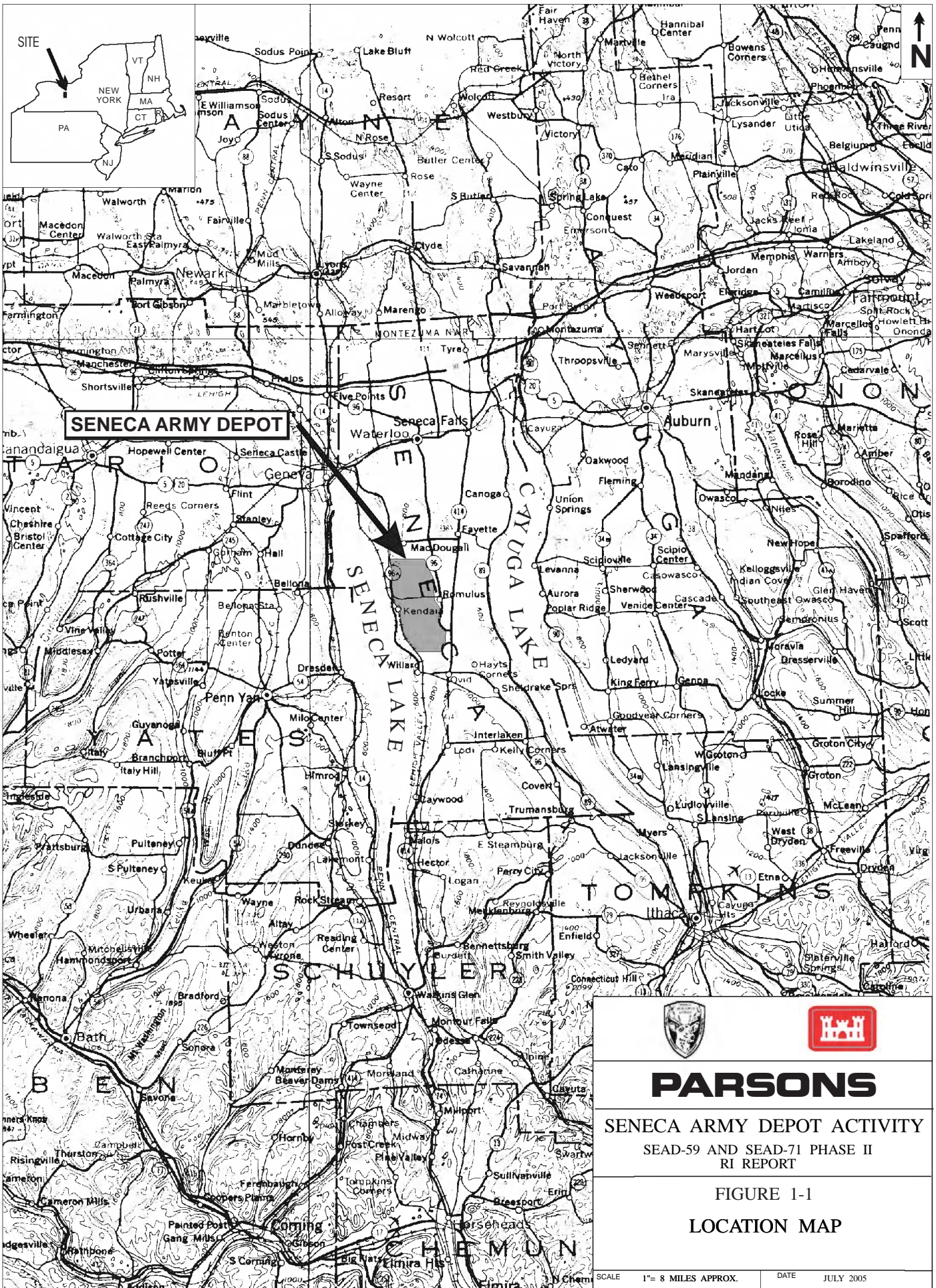

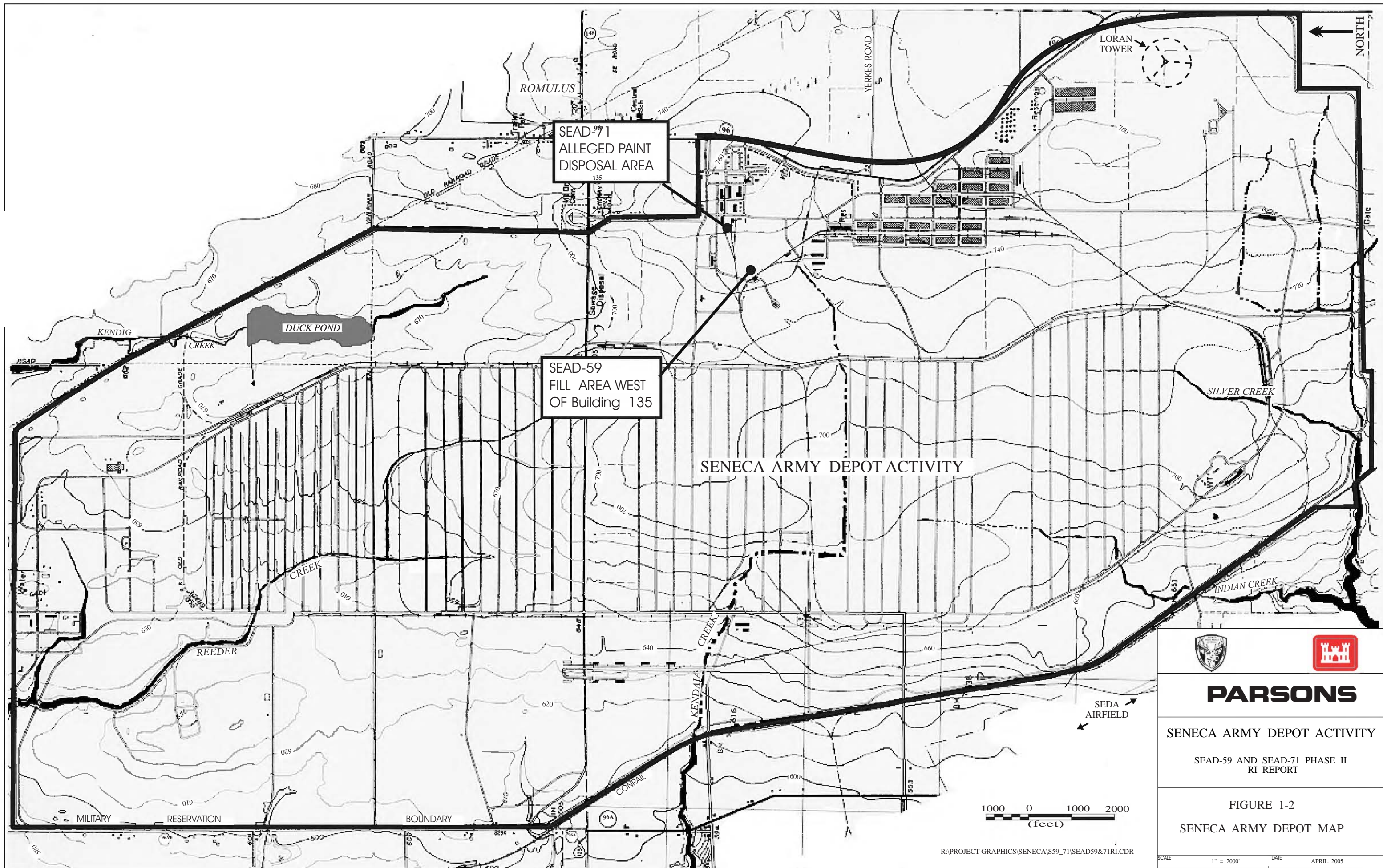

PARSONS

SENECA ARMY DEPOT ACTIVITY

SEAD-59 AND SEAD-71 PHASE II RI REPORT

FIGURE 1-2
SENECA ARMY DEPOT MAP



R:\PROJECT-GRAPHICS\SENECA\S59_71\SEAD59&71RI.CDR

SCALE 1" = 2000' DATE APRIL 2005

path: P:\PIT\Projects\Huntsville HTW\TO #13 SEAD-59_71\RI Report\Pre-Draft\Figures\fig1-3.dwg

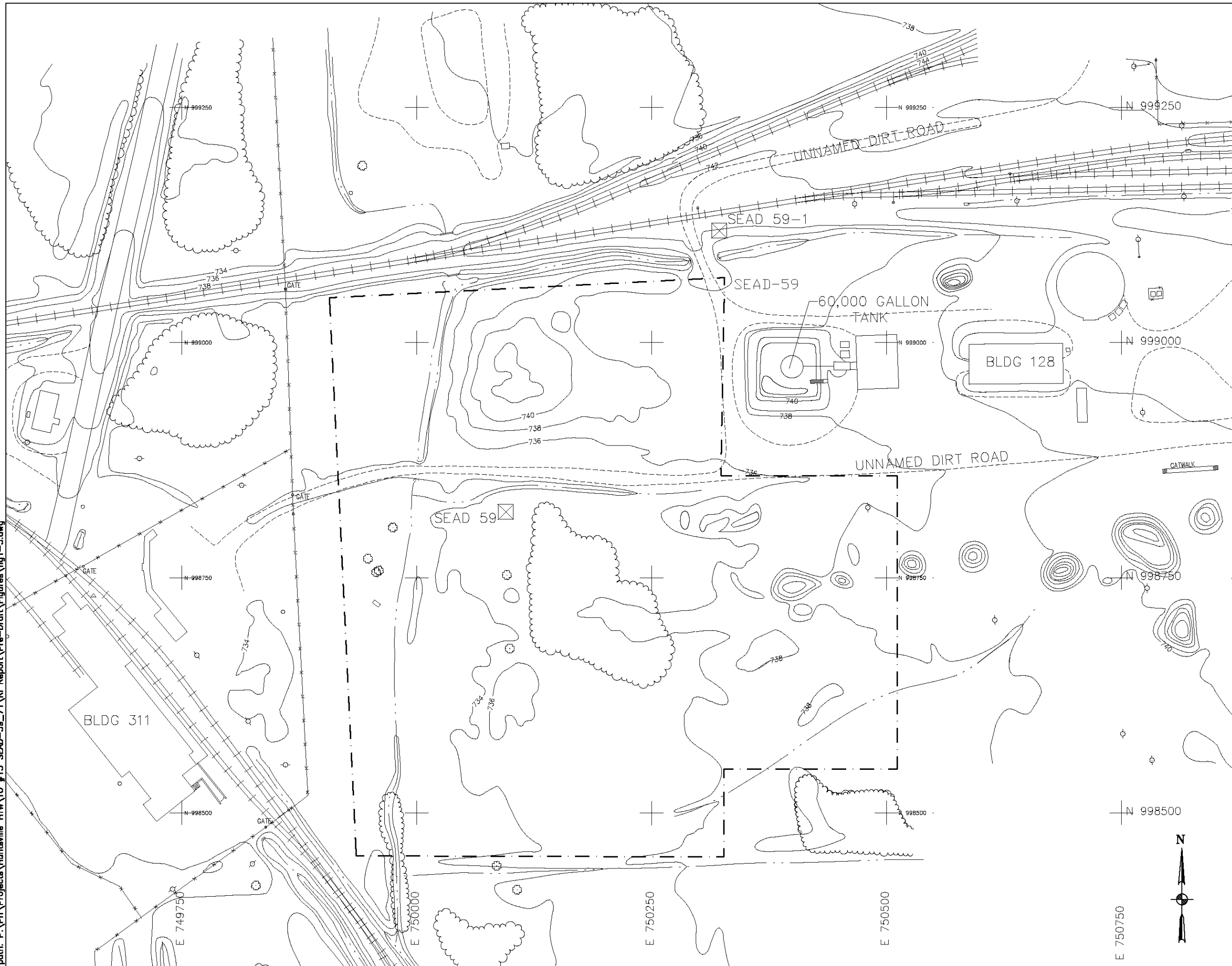

LEGEND

	MINOR WATERWAY		MAJOR WATERWAY
	FENCE		BRUSH LINE
	UNPAVED ROAD		LANDFILL EXTENTS
	RAILROAD		GROUND SURFACE ELEVATION CONTOUR
	ROAD SIGN		DECIDUOUS TREE
	GUIDE POST		MANHOLE
	FIRE HYDRANT		POLE
	OVERHEAD UTILITY POLE		UTILITY BOX
	GUIDE POST		MAILBOX/RR SIGNAL
	COORDINATE GRID (250' GRID)		SURVEY MONUMENT
	APPROXIMATE EXTENT OF AOC		

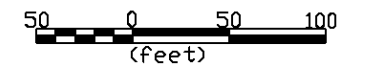

PARSONS

SENECA ARMY DEPOT ACTIVITY
SEAD-59 AND SEAD-71
PHASE II RI REPORT

FIGURE 1-3

SEAD-59
SITE PLAN

April 2005

743519-03000

path: P:\PIT\Projects\Huntsville HTW\TO #13 SEAD-59-71\RI Report\Pre-Draft\Figures\Fig1-4.dwg

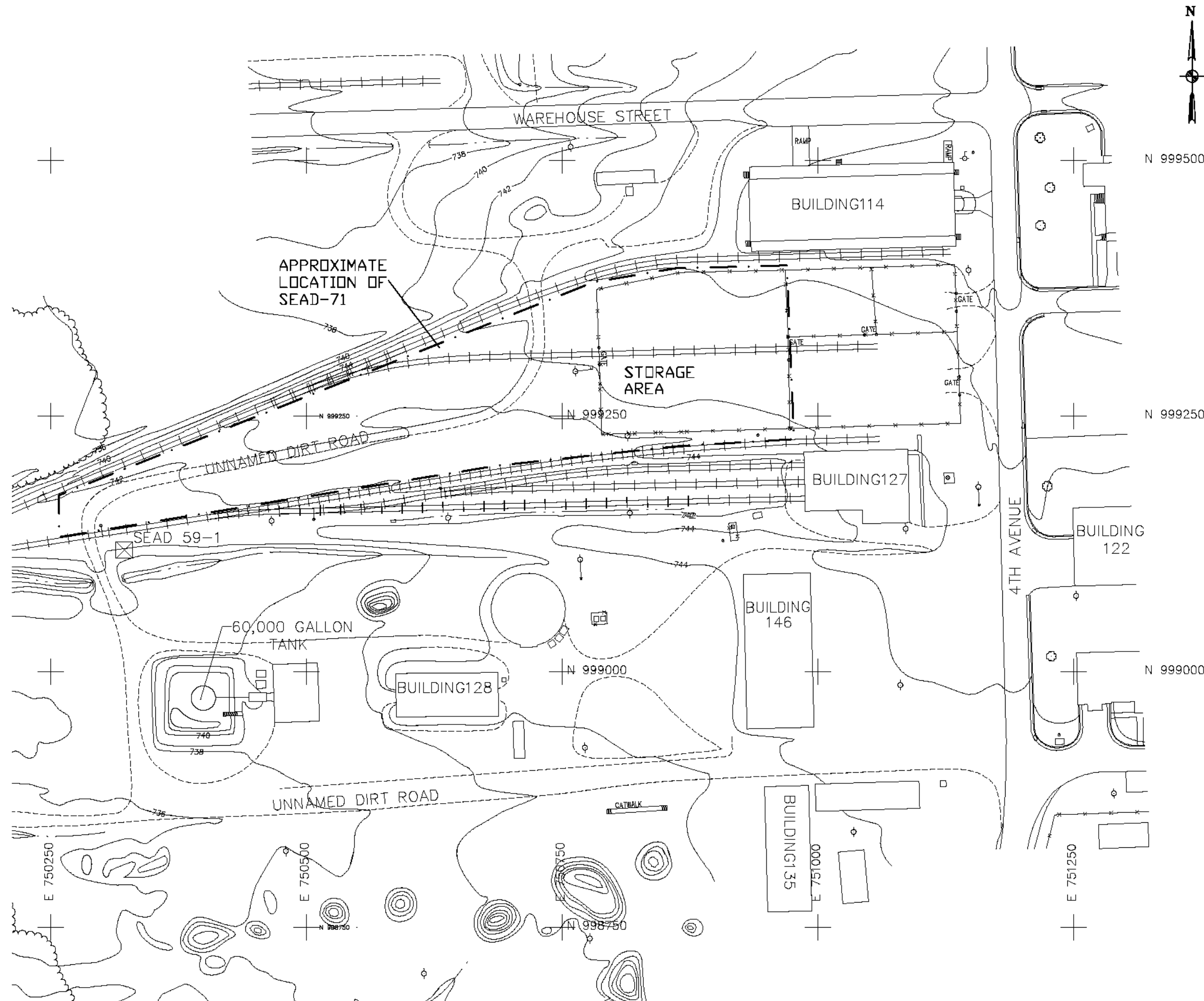

LEGEND

- MINOR WATERWAY
- MAJOR WATERWAY
- FENCE
- UNPAVED ROAD
- BRUSH LINE
- LANDFILL EXTENTS
- RAILROAD
- GROUND SURFACE ELEVATION CONTOUR
- ROAD SIGN
- DECIDUOUS TREE
- GUIDE POST
- FIRE HYDRANT
- MANHOLE
- CORONATE GRID (250' GRID)
- POLE
- UTILITY BOX
- OVERHEAD UTILITY POLE
- MAILBOX/RR SIGNAL
- APPROXIMATE EXTENT OF ADC



PARSONS

SENECA ARMY DEPOT ACTIVITY
SEAD-59 AND SEAD-71
PHASE II RI REPORT

FIGURE 1-4

SEAD-71
SITE PLAN

April 2005

743518-03000

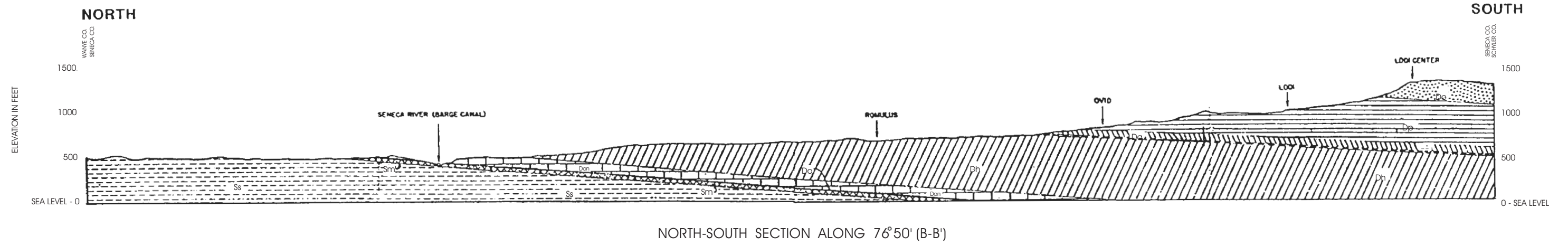
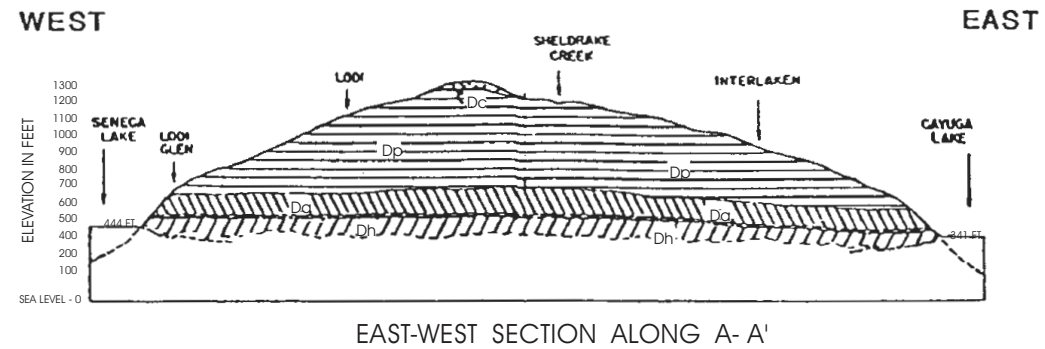

LEGEND

UPPER DEVONIAN	Dc	WISCOY SHALE NUNDA SANDSTONE WEST HILL FORMATION GRIMES SANDSTONE	DEVONIAN
	Dp	HATCH SHALE CASHAQUA SHALE	
	Da	WEST RIVER SHALE GENESEO SHALE	
MIDDLE DEVONIAN	Dh	TULLY LIMESTONE	
MIDDLE OR LOWER DEVONIAN	Don	MOSCOW SHALE LUDLOWVILLE SHALE SKANEATELES SHALE MARCELLUS SHALE	DEVONIAN
LOWER DEVONIAN	Do	ONONDAGA LIMESTONE	
	Sm	ORISKANY SANDSTONE MANLIUS AND RONDOUT LIMESTONES AND COBLESKILL DOLOMITE	
SILURIAN (UPPER)	Ss	SALINA FORMATION INCLUDING BERTIE LIMESTONE MEMBER AND CAMILLUSSHALE MEMBER	
			SILURIAN

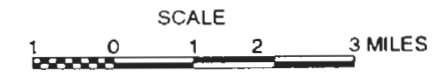

SOURCE: MODIFIED FROM THE GROUND WATER RESOURCES OF SENECA COUNTY, NEW YORK; MOZOLA, A.J., BULLETIN GW-26, ALBANY, NY, 1951

PARSONS

SENECA ARMY DEPOT ACTIVITY
SEAD-59 AND SEAD-71 PHASE II
RI REPORT

FIGURE 1-5
REGIONAL GEOLOGIC
CROSS SECTIONS

SCALE AS NOTED DATE April 2005

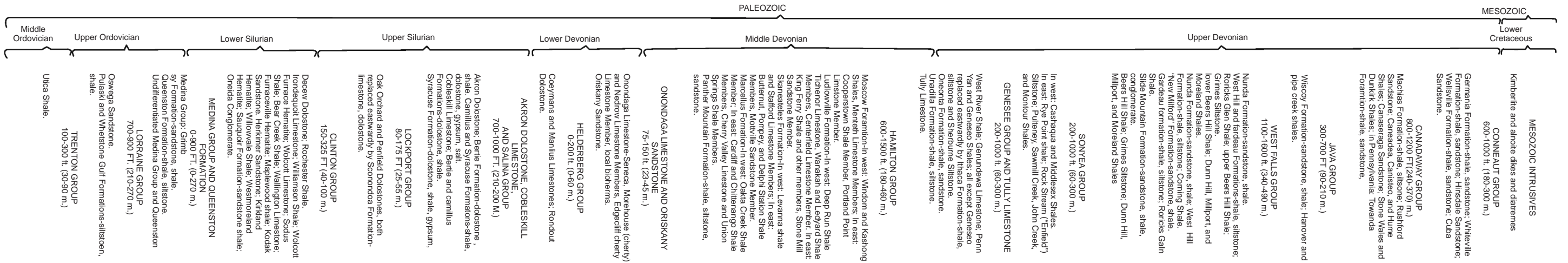

Hamilton group

MOSCOW SHALE	140±	Lower two-thirds of section is a fossiliferous, soft gray calcareous shale; upper third highly friable but less calcareous and fossiliferous. Staining by iron oxide very common. Concretions present in greater abundance in lower beds, but irregular calcareous masses occur throughout section. Joints parallel, tightly sealed, trending N.
LUDLOWVILLE SHALE	140±	Lower beds are thinly laminated, light-colored, fossiliferous, shaly passage beds; overlain by hard calcareous black shales 5 to 12 inches thick and rich in corals and brachiopods; hard layers responsible for falls and cascades. Middle beds are less fossiliferous; soft gray arenaceous shales, rich in concretions, calcareous lenses, and occasional thin sandstone layers. Upper beds (Tichenor limestone member) are thin, irregularly bedded ray shales, becoming light blue gray upon exposure; calcareous, coarsely textured, and fossiliferous. Joints parallel; 2 to 20 inches apart, well sealed.
SKANEAETELES SHALE	185±	Basal beds composed of dark fissile shale. Upper shale more calcareous, grayish to bluish impure limestone layers. Joint pattern N. 75° E. and N. 30° W.; diagonal joints N. 50° E. Joints sealed, parallel and spaced 6 inches to 4 feet apart.
MARCELLUS SHALE	50	Black, slate-like, bituminous shale with occasional limestone layers in sequence, containing zones rich in iron sulfides or calcareous concretions, often with septarian structures; very fissile, iron-stained and gray when weathered. Joint pattern N. 25° W., N. 65° E.; 1 inch



PARSONS

SENECA ARMY DEPOT ACTIVITY
SEAD-59 AND SEAD-71 PHASE II
RI REPORT

FIGURE 1 - 6





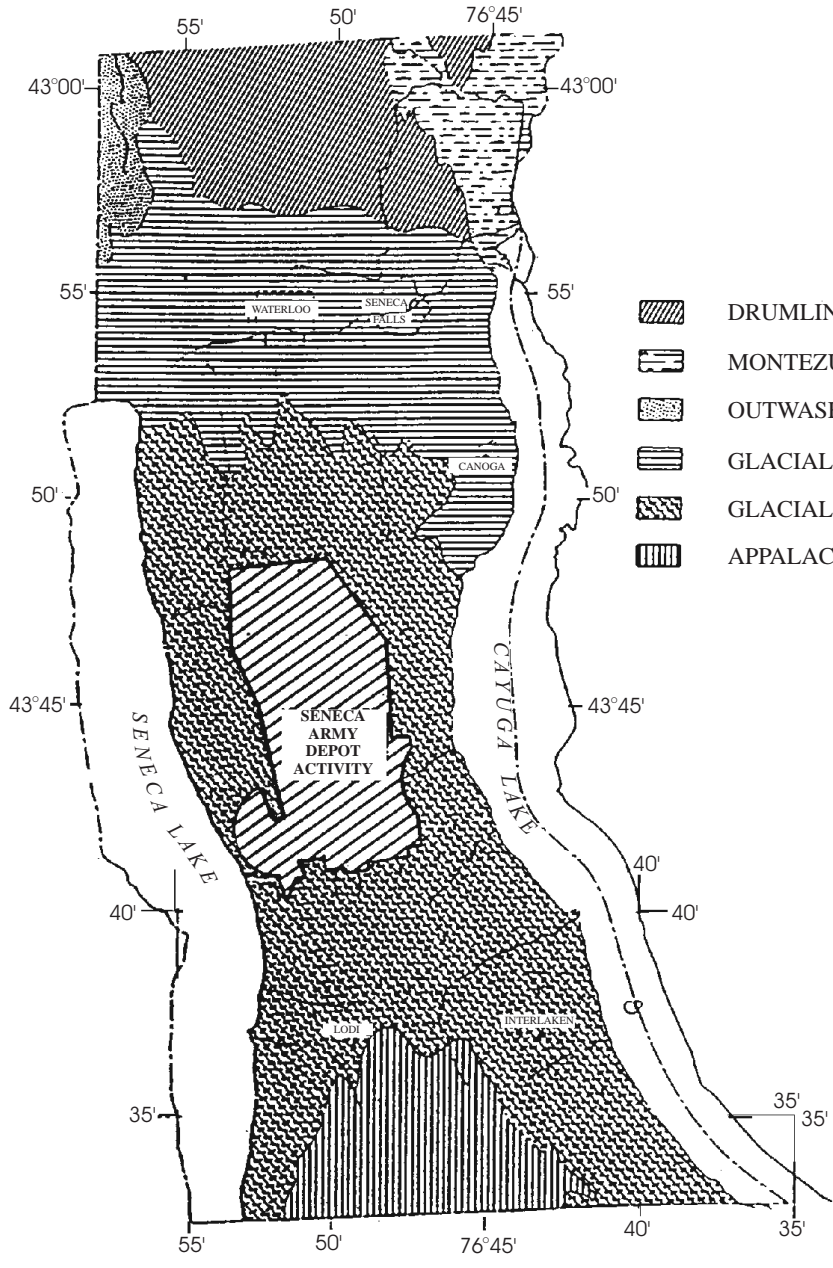

**BEDROCK STRATIGRAPHIC
COLUMN**

April 2005



APARSONS0000



LEGEND

-  DRUMLINS AND DRUMLINOID HILLS
-  MONTEZUMA MARSH AREA
-  OUTWASH PLAINS AND GRAVEL HILLS
-  GLACIAL LAKE PLAIN
-  GLACIAL TILL PLAIN
-  APPALACHIAN PLATEAU

SOURCE: MODIFIED FROM THE GROUND WATER RESOURCES OF SENECA COUNTY, NEW YORK: MOZOLA, A.J., BULLETIN GW-26, ALBANY, NY, 1951

	
PARSONS	
SENECA ARMY DEPOT ACTIVITY SEAD-59 AND SEAD-71 PHASE II RI REPORT	
FIGURE 1-7 PHYSIOGRAPHIC MAP OF SENECA COUNTY	
SCALE	1" = 5 MILES
APRIL 2005	

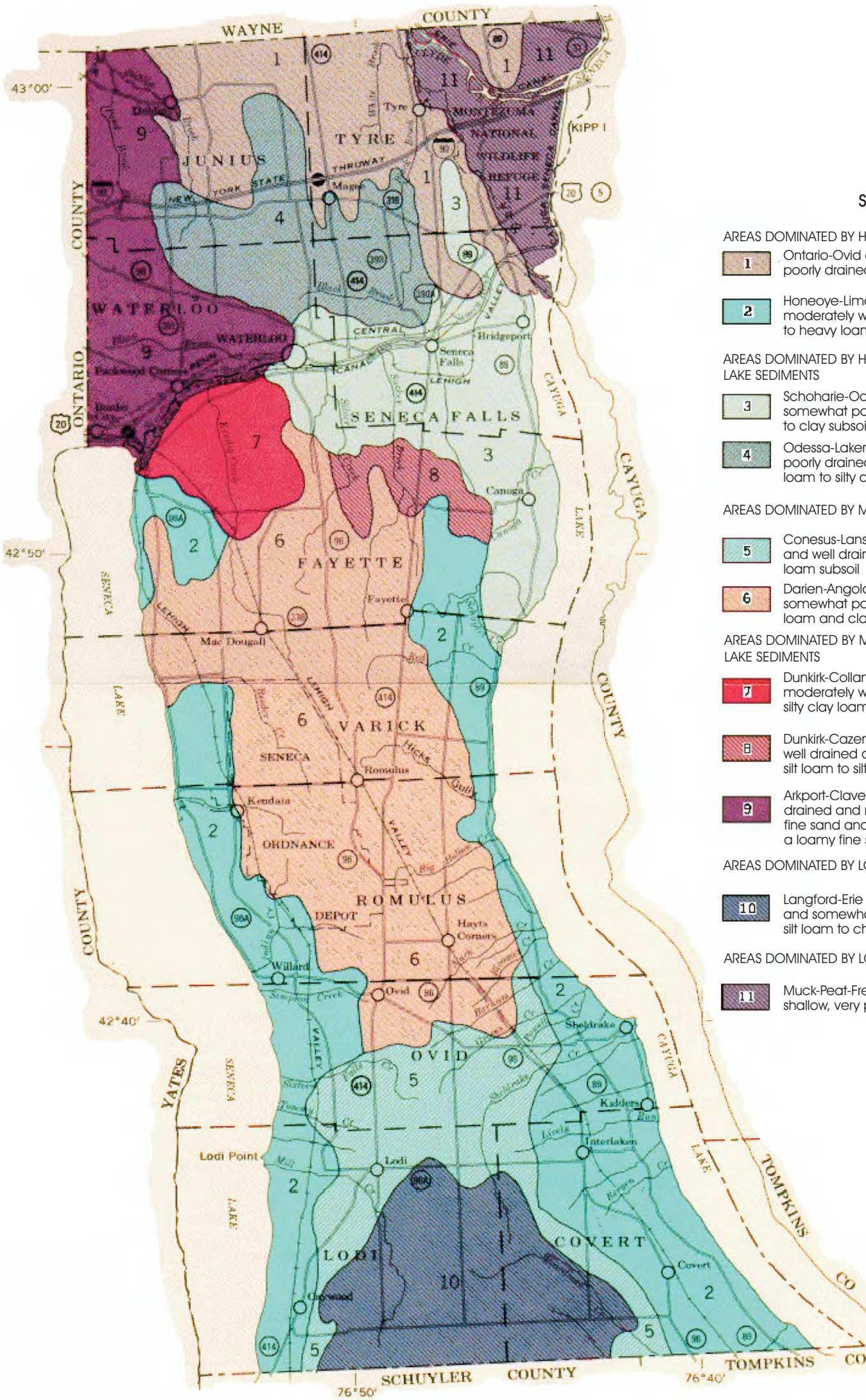
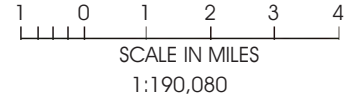

SOIL ASSOCIATIONS

- AREAS DOMINATED BY HIGH-LIME SOILS DEVELOPED IN GLACIAL TILL**
- 1** Ontario-Ovid association: Deep, well-drained to somewhat poorly drained soils that have a loam to silty clay loam subsoil
 - 2** Honeoye-Lima association: Deep, well-drained and moderately well drained soils that have a heavy silt loam to heavy loam subsoil
- AREAS DOMINATED BY HIGH-LIME SOILS DEVELOPED IN GLACIAL LAKE SEDIMENTS**
- 3** Schoharie-Odessa association: Deep, well-drained to somewhat poorly drained soils that have a silty clay loam to clay subsoil
 - 4** Odessa-Lakemont association: Deep, dominantly somewhat poorly drained and poorly drained soils that have a silty clay loam to silty clay subsoil
- AREAS DOMINATED BY MEDIUM-LIME SOILS DEVELOPED IN GLACIAL TILL**
- 5** Conesus-Lansing association: Deep, moderately well drained and well drained soils that have a heavy silt loam to heavy loam subsoil
 - 6** Darien-Angola association: Deep and moderately deep, somewhat poorly drained soils that have a silty clay loam and clay loam subsoil
- AREAS DOMINATED BY MEDIUM-LIME SOILS DEVELOPED IN GLACIAL LAKE SEDIMENTS**
- 7** Dunkirk-Collamer association: Deep well drained and moderately well drained soils that have a silt loam to silty clay loam subsoil
 - 8** Dunkirk-Cazenovia association: Moderately deep and deep, well drained and moderately well drained soils that have a silt loam to silty clay loam subsoil that overlies limestone
 - 9** Arkport-Claverack association: Deep, dominantly well drained and moderately well drained soils that are loamy fine sand and fine sandy loam throughout or that have a loamy fine sand subsoil over silty clay or clay
- AREAS DOMINATED BY LOW-LIME SOILS DEVELOPED IN GLACIAL TILL**
- 10** Langford-Erie association: Deep, moderately well drained and somewhat poorly drained soils that have a channery silt loam to channery loam fragipan
- AREAS DOMINATED BY LOW-LIME SOILS DEVELOPED IN ORGANIC MATERIAL**
- 11** Muck-Peat-Fresh Water Marsh association: Deep to shallow, very poorly drained organic soils

FEBRUARY 1971

SOURCE: U.S. DEPARTMENT OF AGRICULTURE
SOIL CONSERVATION SERVICE
CORNELL UNIVERSITY AGRICULTURAL EXPERIMENT STATION

PARSONS	
SENECA ARMY DEPOT ACTIVITY	
SEAD-59 AND SEAD-71 PHASE II RI REPORT	
FIGURE 1-8	
GENERAL SOIL MAP SENECA COUNTY, NEW YORK	
SCALE 1" = 2000'	DATE APRIL 2005

path: P:\PIT\Projects\Huntsville\HW\TO #13 SEAD-59-71\RI Report\Pre-Draft\Figures\Fig1-9.dwg

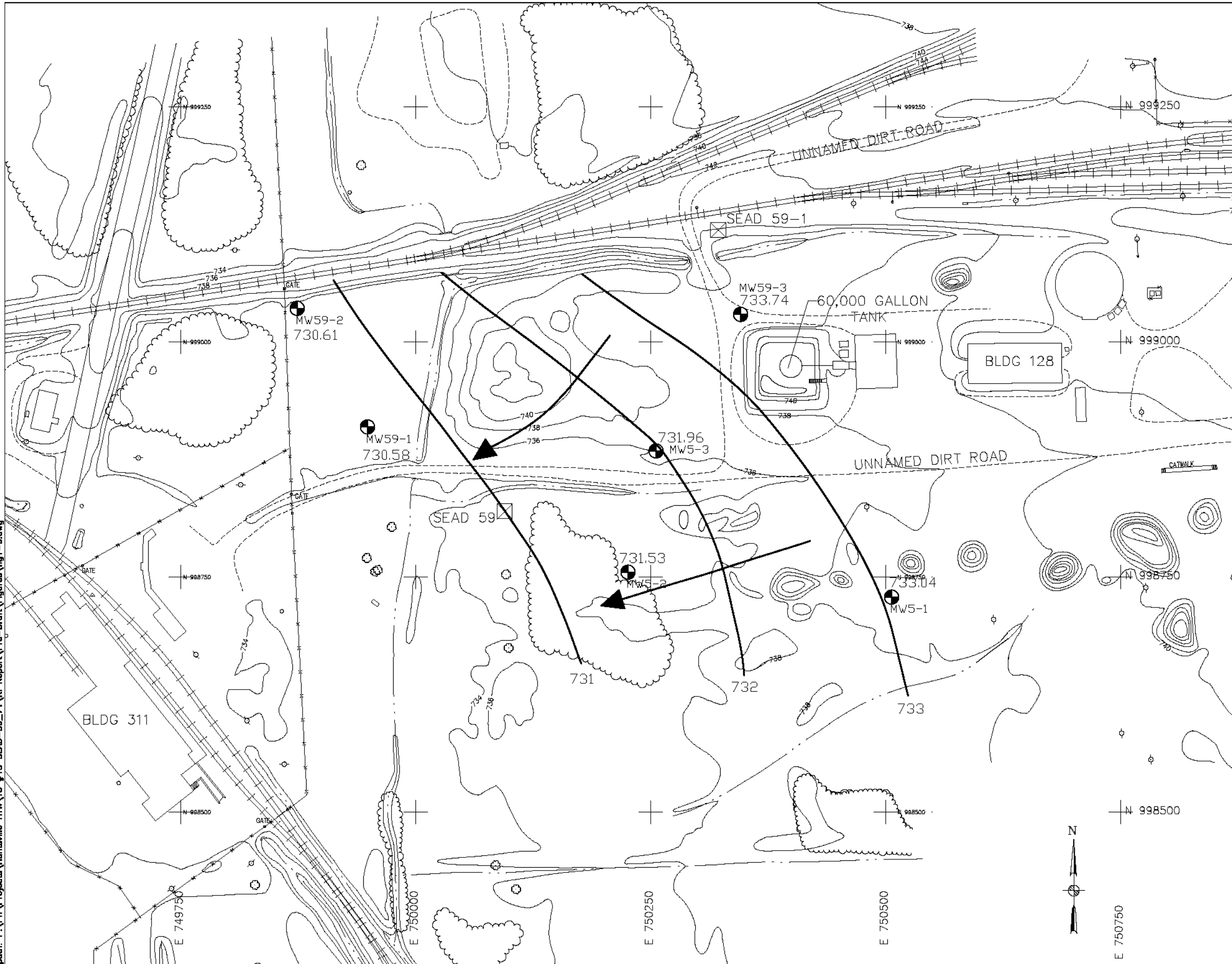

LEGEND

- MINOR WATERWAY
- MAJOR WATERWAY
- FENCE
- UNPAVED ROAD
- BRUSH LINE
- LANDFILL EXTENTS
- RAILROAD
- 760 — GROUND SURFACE ELEVATION CONTOUR
- ☐ ROAD SIGN
- ⊕ DECIDUOUS TREE
- △ GUIDE POST
- ⊕ FIRE HYDRANT
- ⊗ MANHOLE
- ⊕ COORDINATE GRID (250' GRID)
- POLE
- UTILITY BOX
- OVERHEAD UTILITY POLE
- MAILBOX/RR SIGNAL

LEGEND

- MW59-1
730.61
● MONITORING WELL WITH WATER TABLE ELEVATION
- 731
↘ GROUNDWATER ELEVATION CONTOUR (ARROW INDICATES DIRECTION OF FLOW)
- GROUNDWATER LEVEL MEASUREMENTS MADE ON 7/6/94

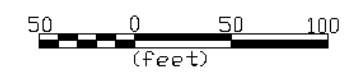

PARSONS

SENECA ARMY DEPOT ACTIVITY
SEAD-59 AND SEAD-71
PHASE II RI REPORT

FIGURE 1-9

SEAD-59
ESI GROUNDWATER ELEVATION MAP





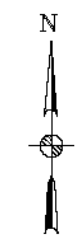

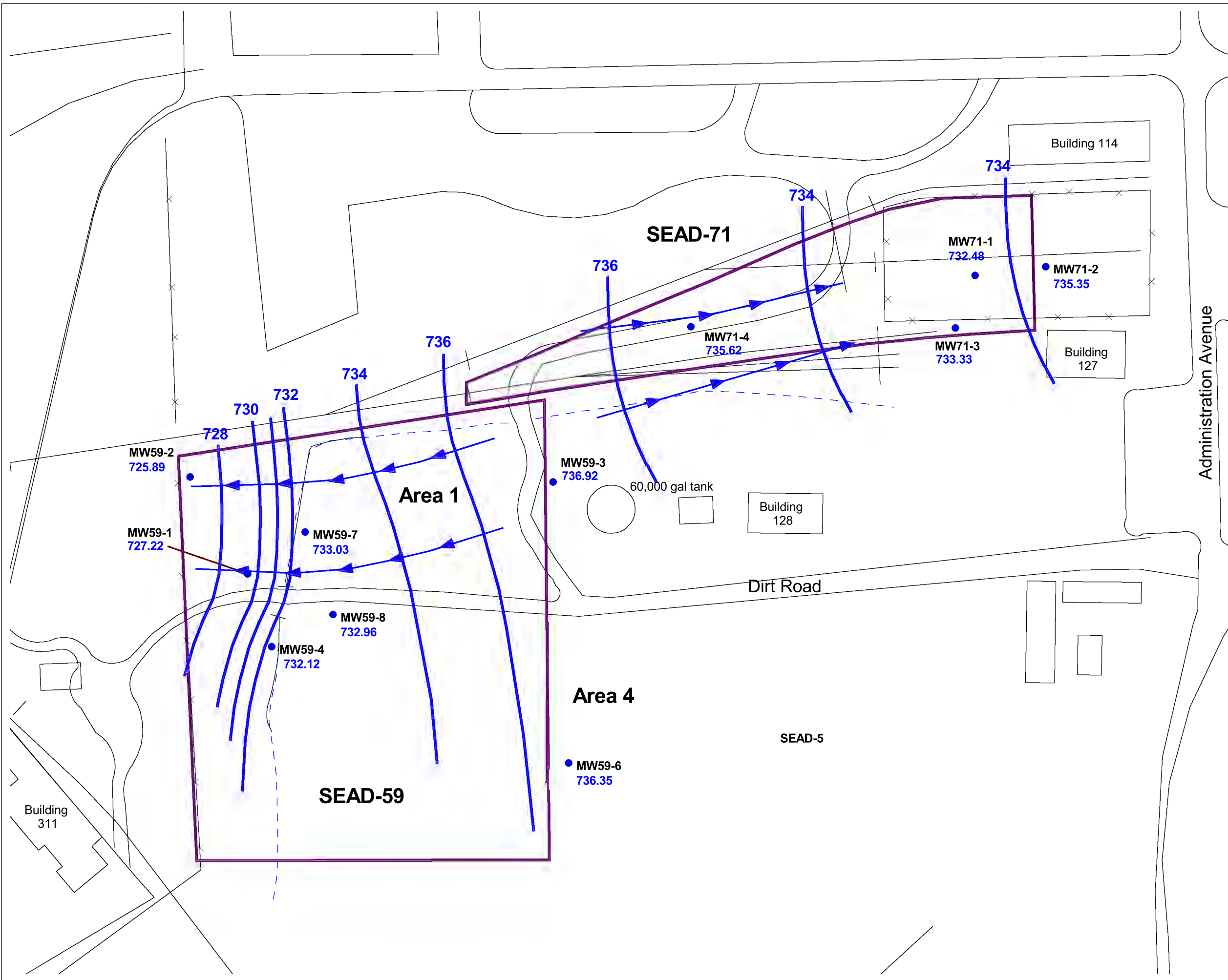
April 2005

743518-03000





LEGEND

-  Existing Monitoring Well
-  Groundwater Contour
-  Direction of Groundwater Flow
-  Stream
-  Fence
-  Railroad Tracks
-  Approximate SEAD Boundary

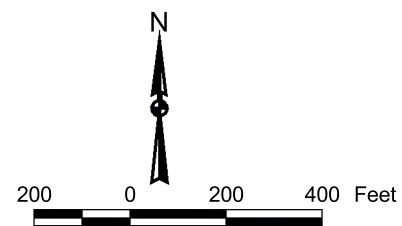

PARSONS

**SENECA ARMY DEPOT ACTIVITY
SEAD-59 and SEAD-71 Phase II
RI Report**

**FIGURE 1-9A
SEAD 59/71
GROUNDWATER ELEVATION MAP**

path: P:\PIT\Projects\Huntsville HTW\TO #13 SEAD-59-71\RI Report\Pre-Draft\Figures\Fig1-10.dwg

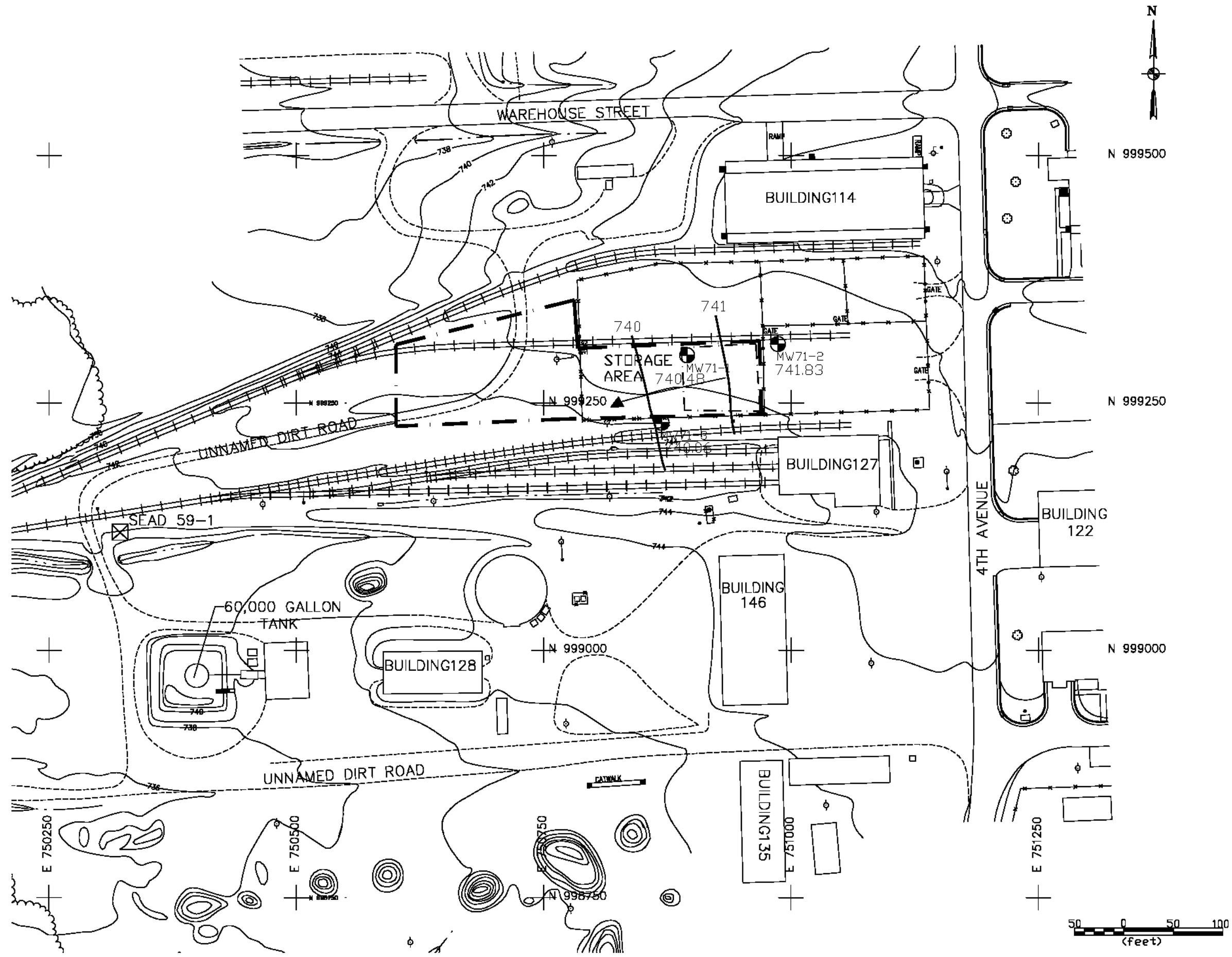

LEGEND

- MINOR WATERWAY
 - MAJOR WATERWAY
 - FENCE
 - UNPAVED ROAD
 - BRUSH LINE
 - APPROXIMATE LANDFILL EXTENT
 - ===== RAILROAD
 - 750 --- GROUND SURFACE ELEVATION CONTOUR
 - ELECTRIC UTILITY LINE
 - UNDERGROUND WATER UTILITY LINE
 - ⊕ ROAD SIGN
 - ⊗ DECIDUOUS TREE
 - △ GUIDE POST
 - ⊕ FIRE HYDRANT
 - ⊗ MANHOLE
 - + COORDINATE GRID (250' GRID)
 - POLE
 - UTILITY BOX
 - MAILBOX/RR SIGNAL
 - OVERHEAD UTILITY POLE
 - ⊗ SURVEY MONUMENT
- (NOT ALL SYMBOLS MAY APPEAR ON MAP)

- APPROXIMATE AOC EXTENT
- AOC EXTENT FROM THE 15 SWMU ESI WORK PLAN
- MW71-1
⊕
740.48
MONITORING WELL WITH WATER TABLE ELEVATION
- 740
▲
GROUNDWATER ELEVATION CONTOUR (ARROW INDICATES DIRECTION OF FLOW)
- GROUNDWATER LEVEL MEASUREMENTS MADE ON 7/6/94



PARSONS

SENECA ARMY DEPOT ACTIVITY
SEAD-59 AND SEAD-71
PHASE II RI REPORT

FIGURE 1-10

SEAD-71
ESI GROUNDWATER ELEVATION MAP

April 2005

743518-03000



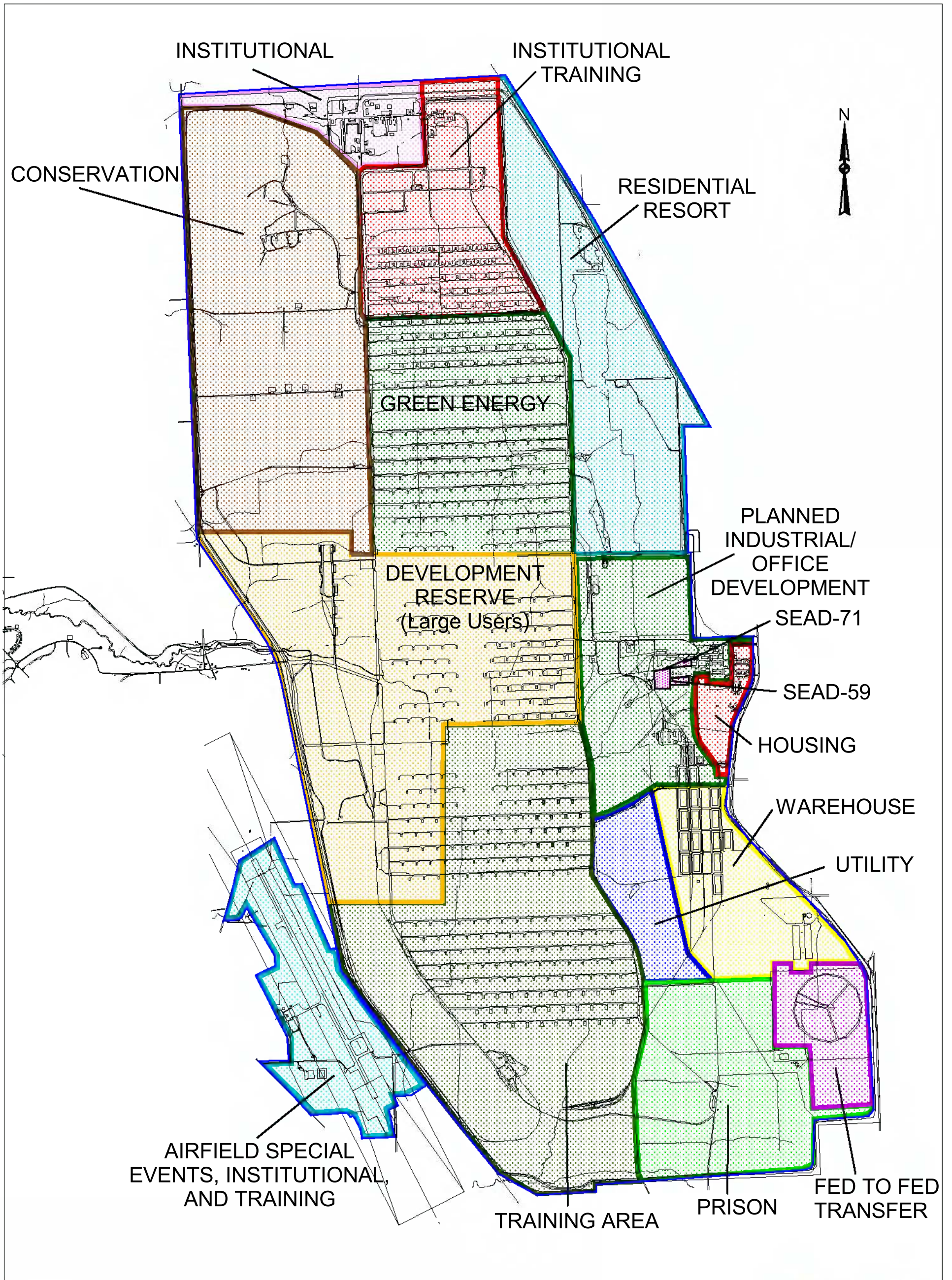

LEGEND

 SEAD Boundary

5000 0 5000 10000 Feet



PARSONS

SENECA ARMY DEPOT ACTIVITY
SEAD-59 AND SEAD-71 PHASE II
RI REPORT

FIGURE 1-11
FUTURE LAND USE

April 2006 JOB NUMBER: 743519-03000

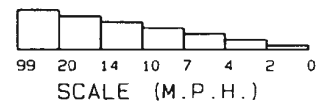
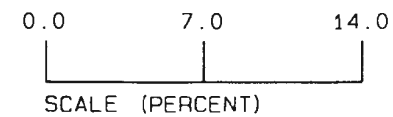
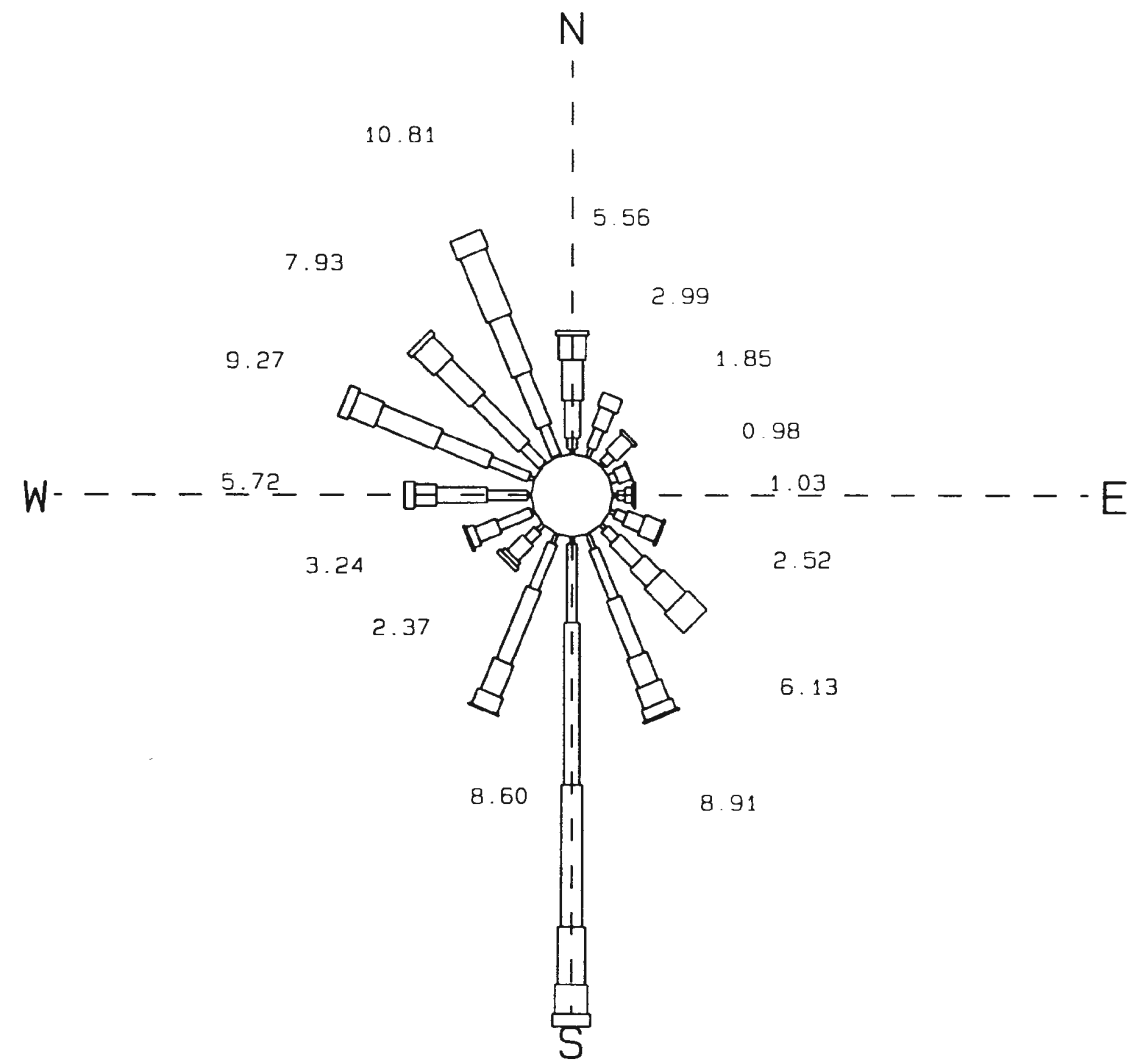

TOTAL HOURS: 2928
PERCENT CALM: 0.00

**SENECA ARMY DEPOT
SENECA 10-M MET. TOWER
SEASONAL WIND ROSE
10 METER LEVEL APRIL 24 - JULY 14 1995**

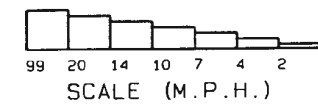
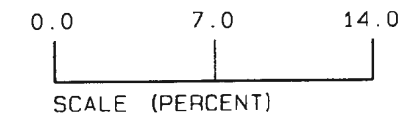
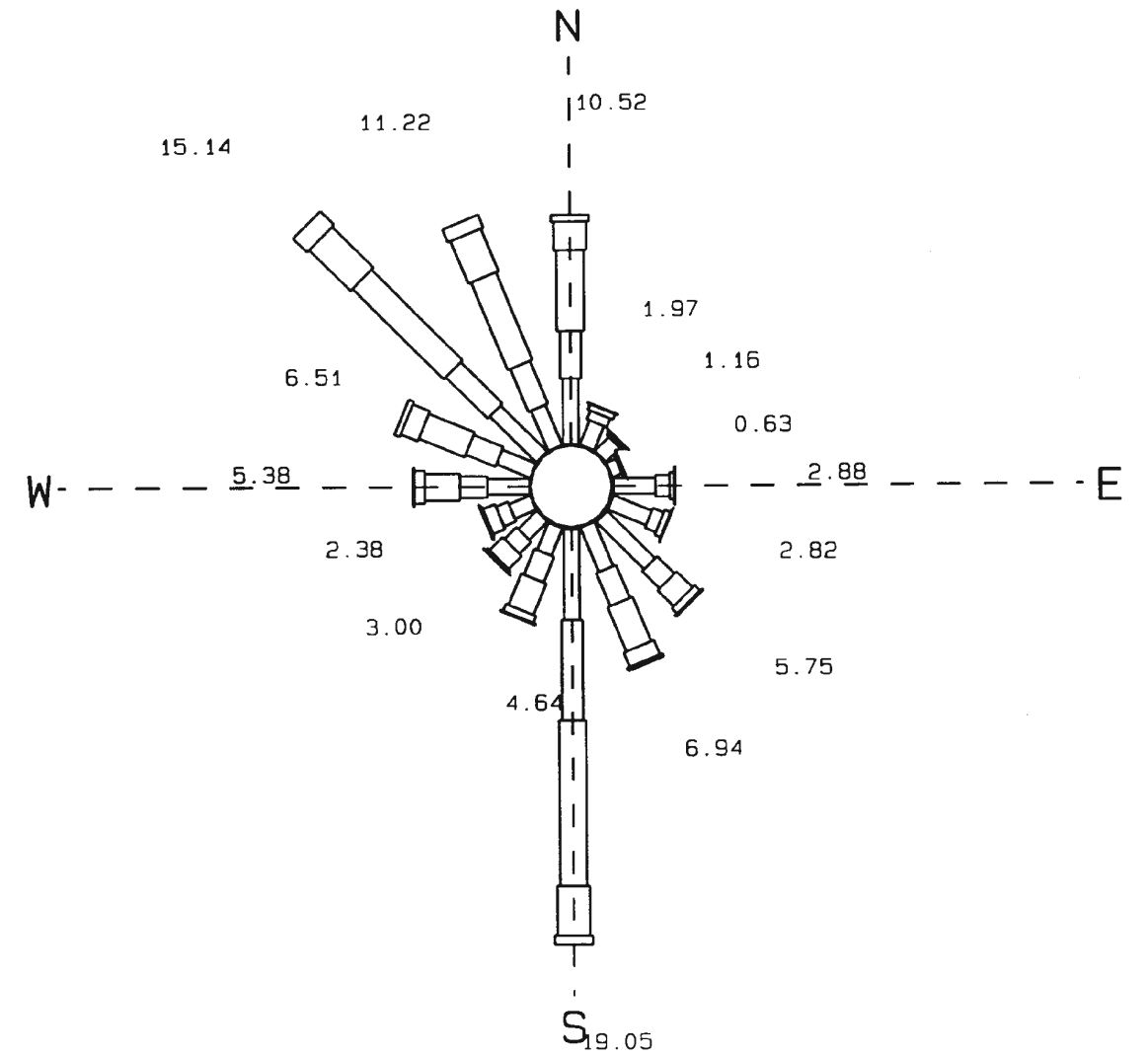

TOTAL HOURS: 29307
PERCENT CALM: 14.29
PERCENT MISSING: 0.00

**SENECA ARMY DEPOT
ITHACA AIRPORT
ANNUAL WIND ROSE
20 FOOT LEVEL FOR: 1989-1993**



PARSONS

SENECA ARMY DEPOT ACTIVITY
SEAD-59 AND SEAD-71PHASE II
RI REPORT

FIGURE 1-12
WIND ROSES

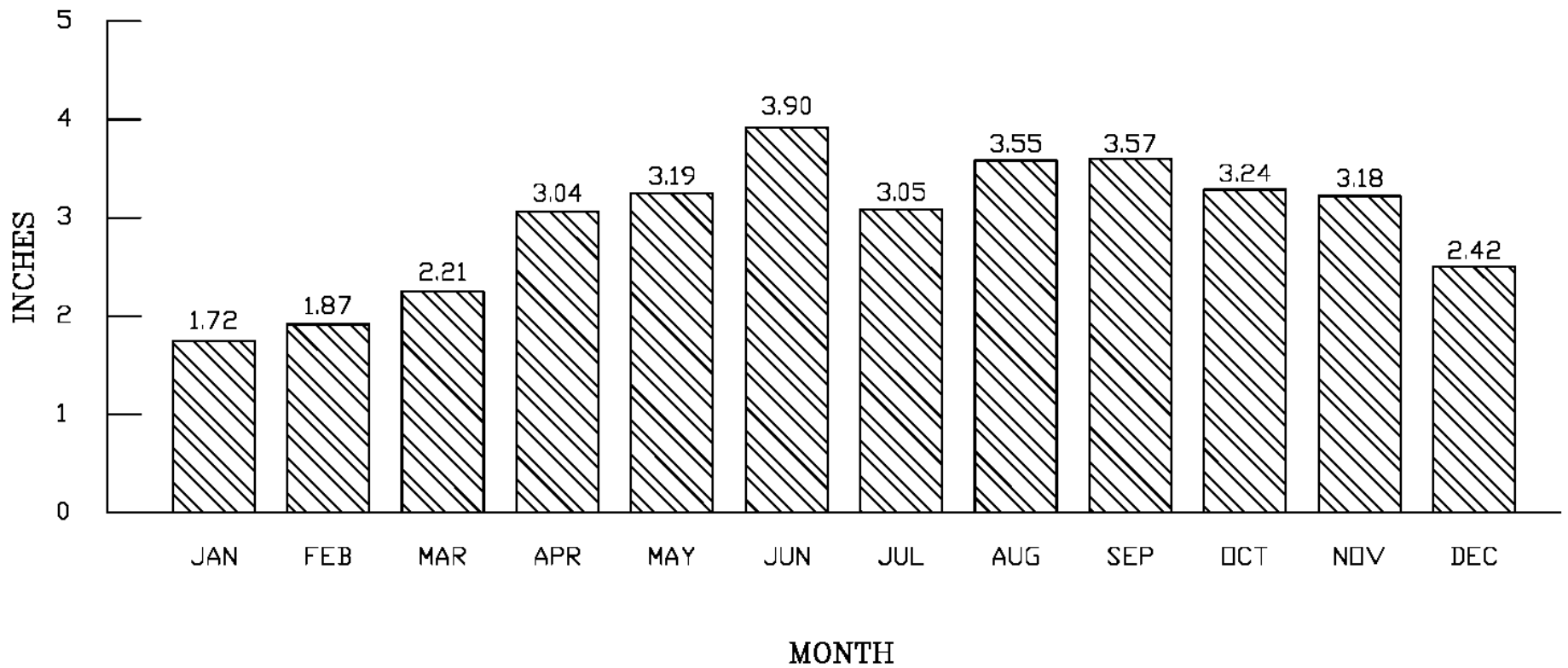

DATA IS FROM THE NORTHEAST REGIONAL CLIMATE CENTER, CORNELL UNIVERSITY, ITHACA, NY AND IS GIVEN A MONTHLY AVERAGE PRECIPITATION AVERAGED OVER THE YEARS 1957 THROUGH 1991.



PARSONS

SENECA ARMY DEPOT ACTIVITY

**SEAD-69 AND SEAD-71
PHASE II III REPORT**

**FIGURE 1-13
AVERAGE MONTHLY PRECIPITATION
IN PROXIMITY OF
SENECA ARMY DEPOT ACTIVITY**

April 2005

743518-03000

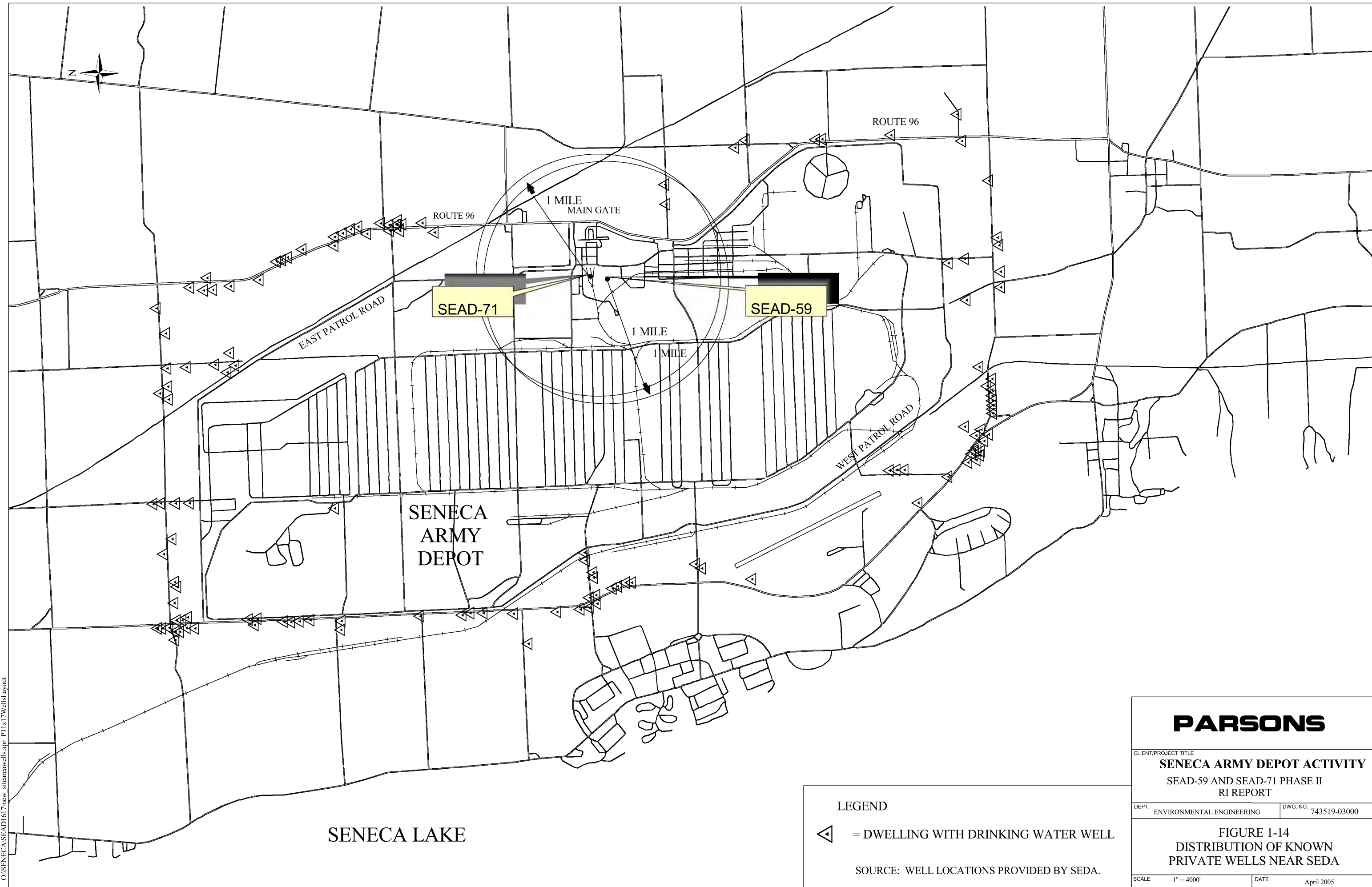

O:\SENECA\SEAD\1617\new_sitenearewells.apr P1\1617WellsLayout

PARSONS

CLIENT/PROJECT TITLE
SENECA ARMY DEPOT ACTIVITY
 SEAD-59 AND SEAD-71 PHASE II
 RI REPORT

DEPT. ENVIRONMENTAL ENGINEERING DWG. NO. 743519-03000

FIGURE 1-14
 DISTRIBUTION OF KNOWN
 PRIVATE WELLS NEAR SEDA

SCALE 1" = 4000' DATE April 2005

path: P:\PIT\Projects\Huntsville HTW\To #13 SEAD-59-71\RI Report\Pre-Draft\Figures\Fig2-1.dwg

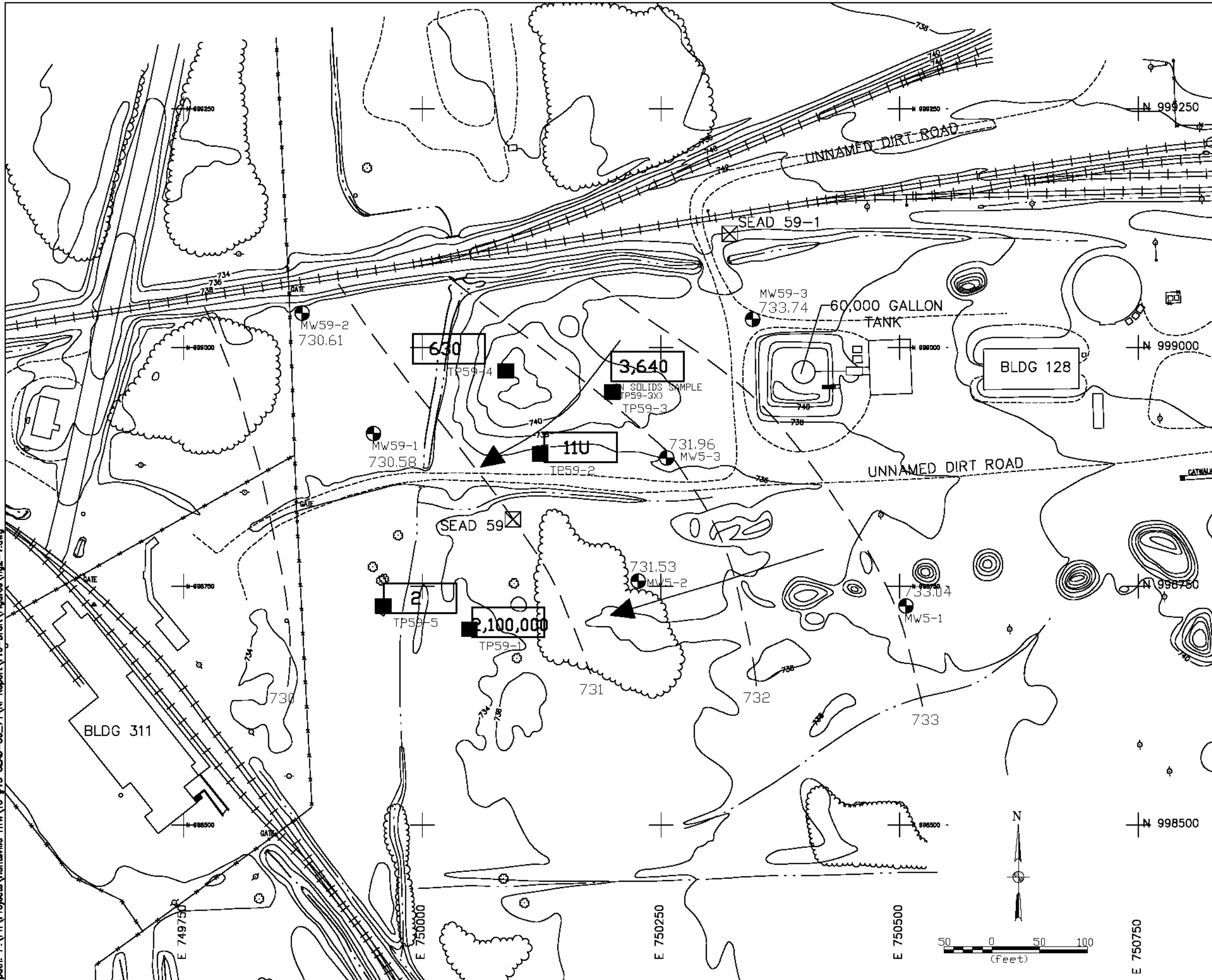

LEGEND

- MINOR WATERWAY
- MAJOR WATERWAY
- FENCE
- UNPAVED ROAD
- BRUSH LINE
- LANDFILL EXTENTS
- RAILROAD
- GROUND SURFACE ELEVATION CONTOUR
- ROAD SIGN
- DECIDUOUS TREE
- GUIDE POST
- FIRE HYDRANT
- MANHOLE
- COORDINATE GRID (250' GRID)
- POLE
- UTILITY BOX
- OVERHEAD UTILITY POLE
- MAILBOX/RR SIGNAL

LEGEND

- TEST PIT
 - 3,640** BTEX (ug/kg) IN SOIL/SOLIDS
 - MW59-1
733.74 MONITORING WELL WITH WATER TABLE ELEVATION
 - 733 GROUNDWATER ELEVATION CONTOUR (ARROW INDICATES DIRECTION OF FLOW)
- GROUNDWATER LEVEL MEASUREMENTS MADE ON 7/8/94



PARSONS

SENECA ARMY DEPOT ACTIVITY
SEAD-59 AND SEAD-71
PHASE II RI REPORT

FIGURE 2-1

SEAD-59 FILL AREA WEST OF BLDG.135
BTEX IN SOILS

April 2005

743519-03000

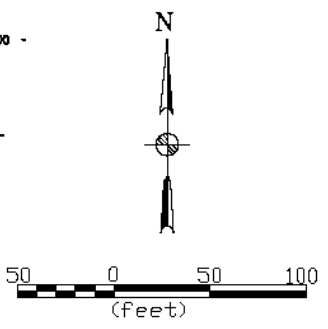

o:\seneca\sead63\sead5971\copy_sead59.apr SEAD-59 Sample Location

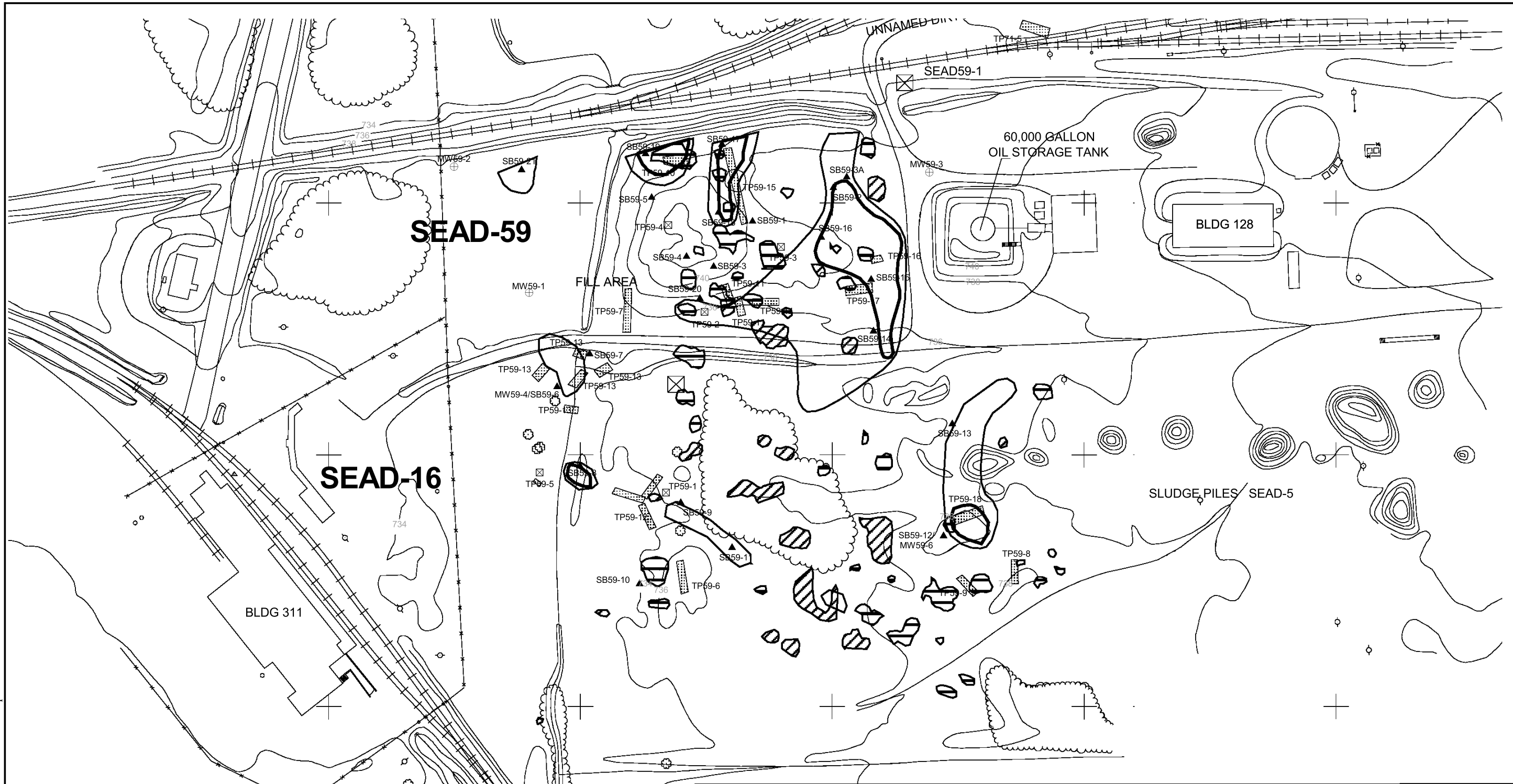

- Base Map Features
- Phase I RI Test Pit Locations
- ESI Test Pit Locations
- Monitoring Well Location
- Soil Boring Location

- Suspected Source of Geophysical Anomalies**
- Known Surface Debris
 - Unknown
- Soil Gas**
- 20 ppm or greater
 - 10 ppm - 20 ppm

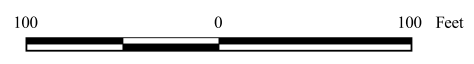

PARSONS

SENECA ARMY DEPOT ACTIVITY
SEAD-59 AND SEAD-71 PHASE II
RI REPORT

FIGURE 2-2
SENECA ARMY DEPOT ACTIVITY
SEAD-59 ESI and Phase I RI
Sample Locations

April 2005

743519-03000

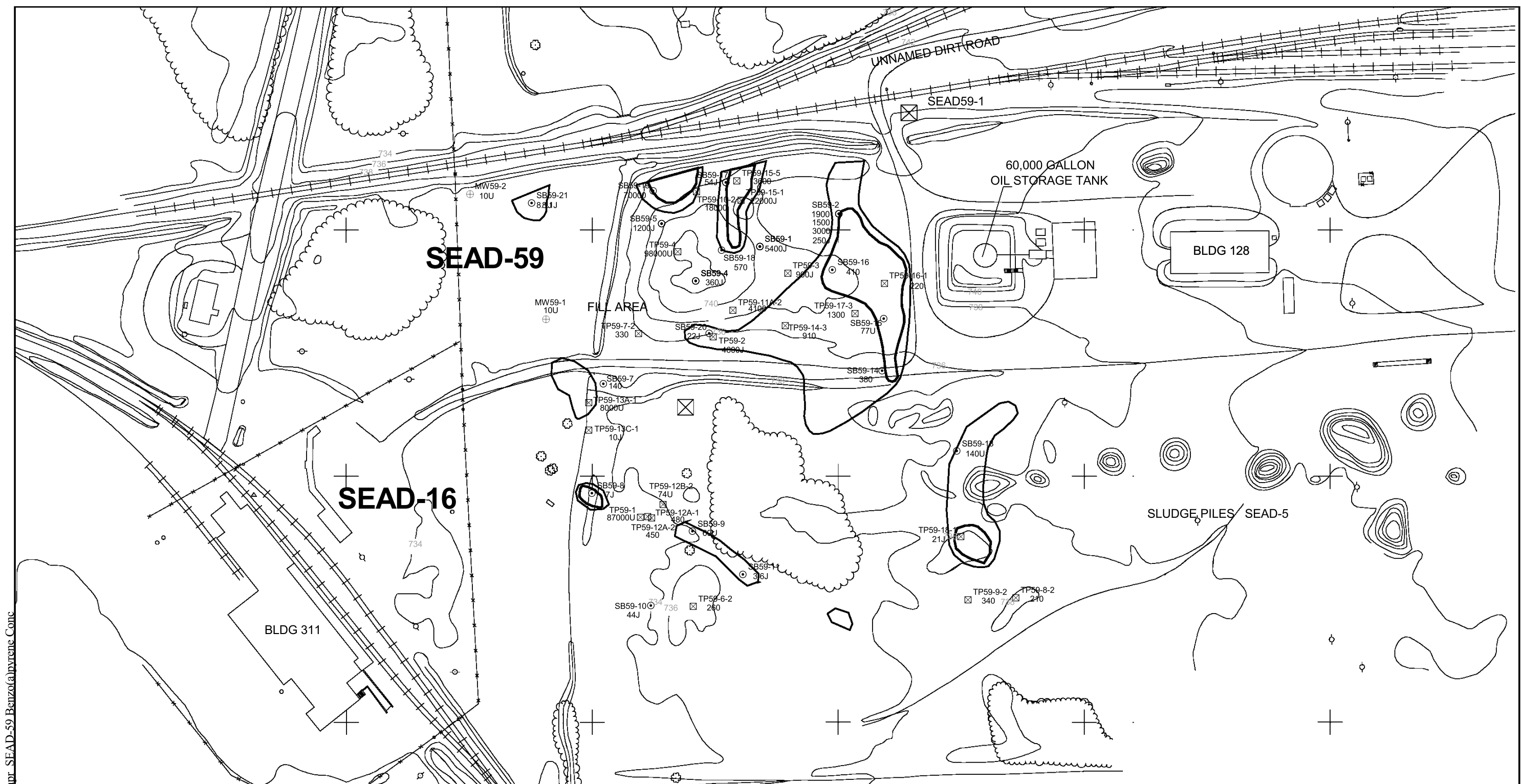

o:\seneca\sead63\sead5971\copy_sead59.apr_SEAD-59_Benzo[a]pyrene_Conc

	Base Map Features		Soil Gas 20 ppm or greater
	ESI Test Pit Locations with Loc Id and Benzo[a]pyrene conc (ug/Kg)		10 ppm - 20 ppm
	Monitoring Well Location with Loc Id and Benzo[a]pyrene conc (ug/Kg)		
	Soil Boring Location with Loc Id and Benzo[a]pyrene conc (ug/Kg)		

100 0 100 Feet

N

PARSONS
SENECA ARMY DEPOT ACTIVITY SEAD-59 AND SEAD-71 PHASE II RI REPORT
FIGURE 2-3 SEAD-59 PHASE I RI TOTAL BENZO[A]PYRENE CONCENTRATIONS IN SOIL
April 2005 743519-03000

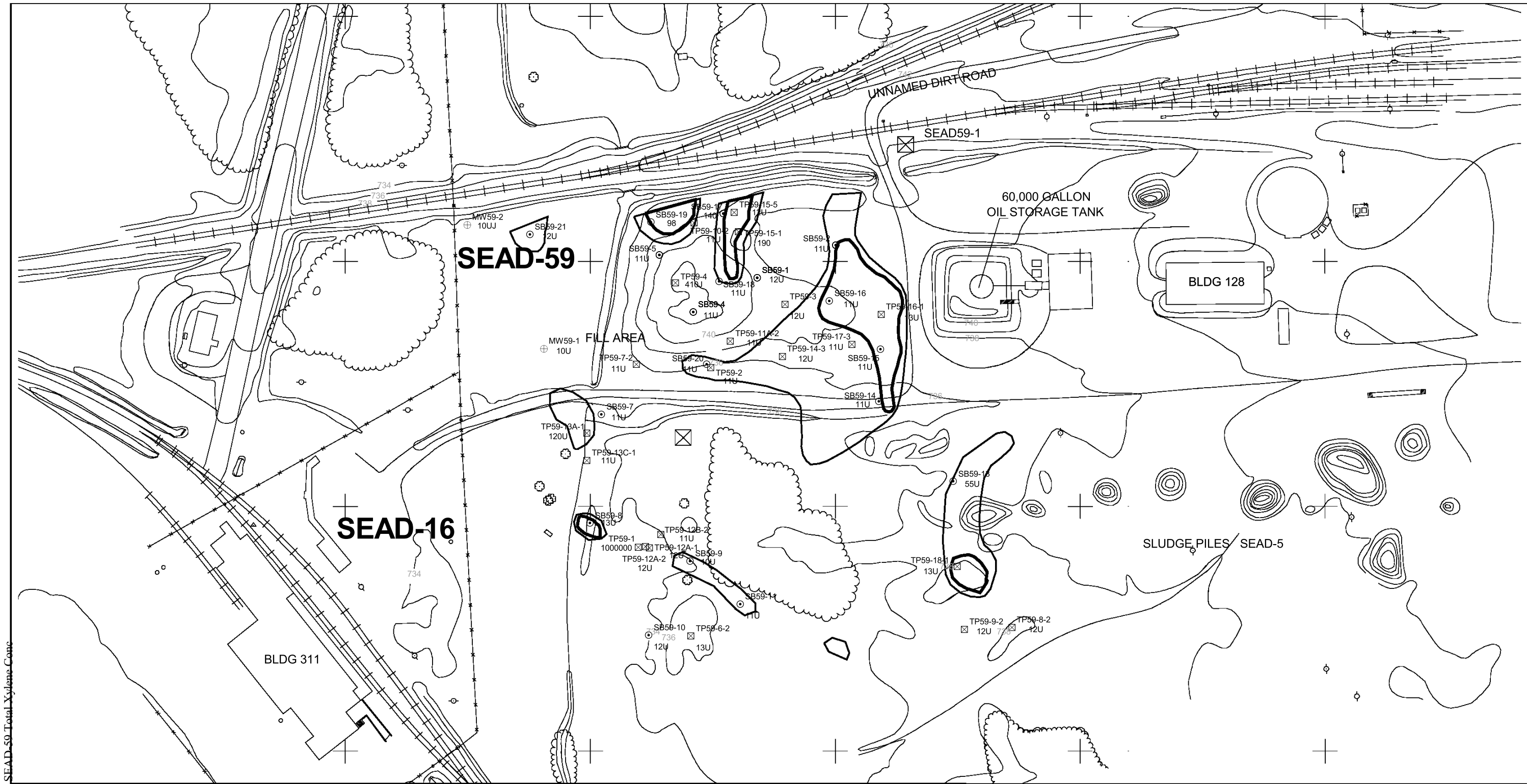

c:\seneca\sead63\sead5071\copy_sead59.apr SEAD_59_Total_Xylene Conc

Base Map Features

Soil Gas

- 20 ppm or greater
- 10 ppm - 20 ppm

- ESI Test Pit Locations
- Monitoring Well Location
- Soil Boring Location

100 0 100 200 Feet



Concentration of Xylene in Soil (ug/kg)







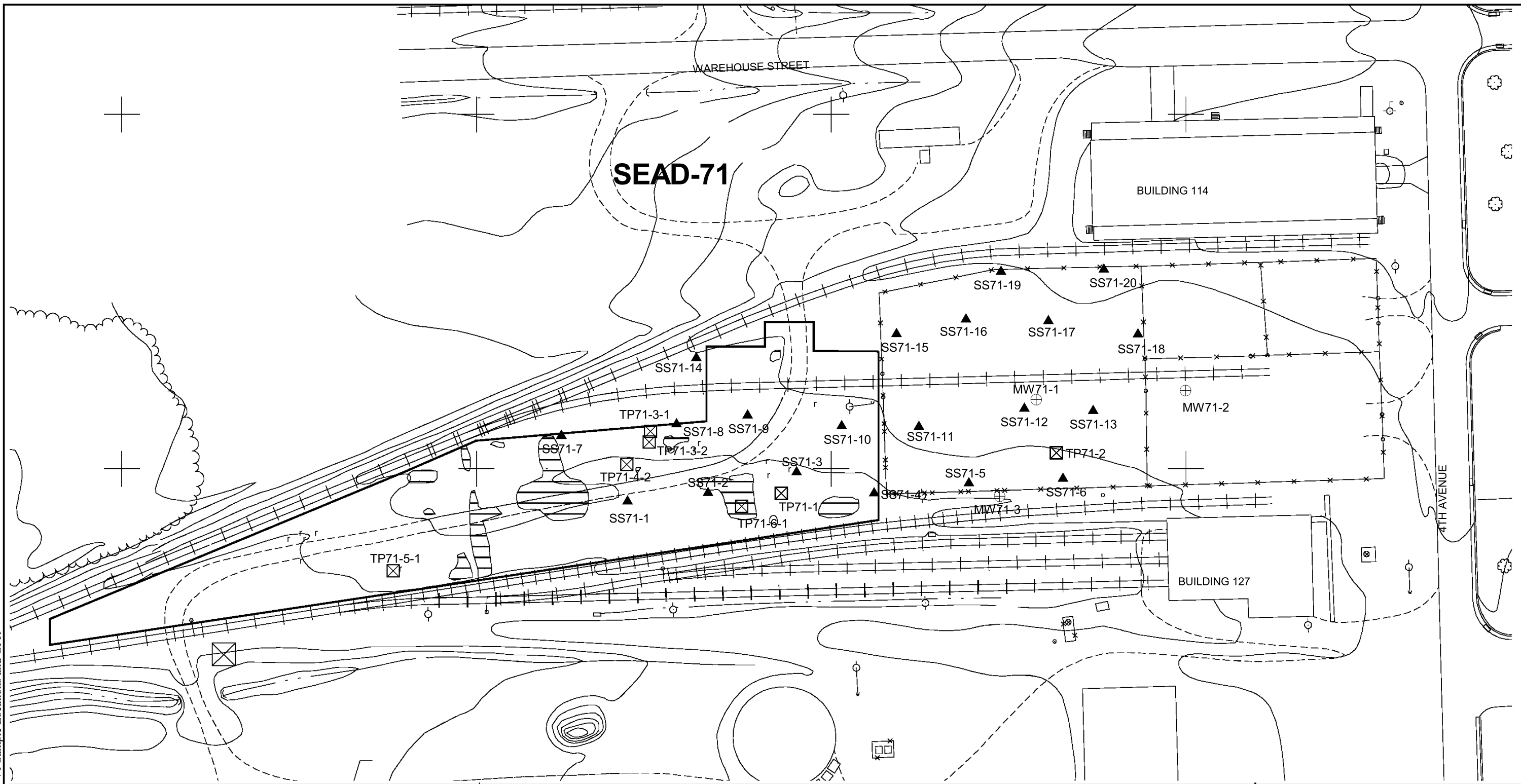

PARSONS

SENECA ARMY DEPOT ACTIVITY
SEAD-59 AND SEAD-71 PHASE II
RI REPORT

FIGURE 2-4
SEAD-59 PHASE I RI
TOTAL XYLENE CONCENTRATIONS
IN SOIL

o:\seneca\sead5971\copy_sead59.apr SEAD-71 Sample Locations and GPR



-  Base Map Features
-  Suspected Locations of GPR Anomalies
-  Approximate Extent of 1997 GPR Survey
-  Test Pit Locations
-  Monitoring Well Location (installed during ESI)
-  Soil Boring/Soil Sample Location

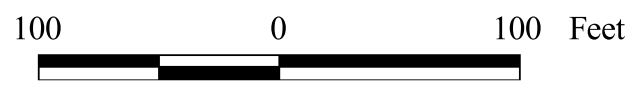

PARSONS

SENECA ARMY DEPOT ACTIVITY
SEAD-59 AND SEAD-71 PHASE II
RI REPORT

FIGURE 2-5
SEAD-71 PHASE I RI
SAMPLING LOCATIONS AND GPR RESULTS

April 2005

743519-03000

o:\seneca\sead5971\copy_sead59.apr SEAD-71 Benzo(a)pyrene Conc

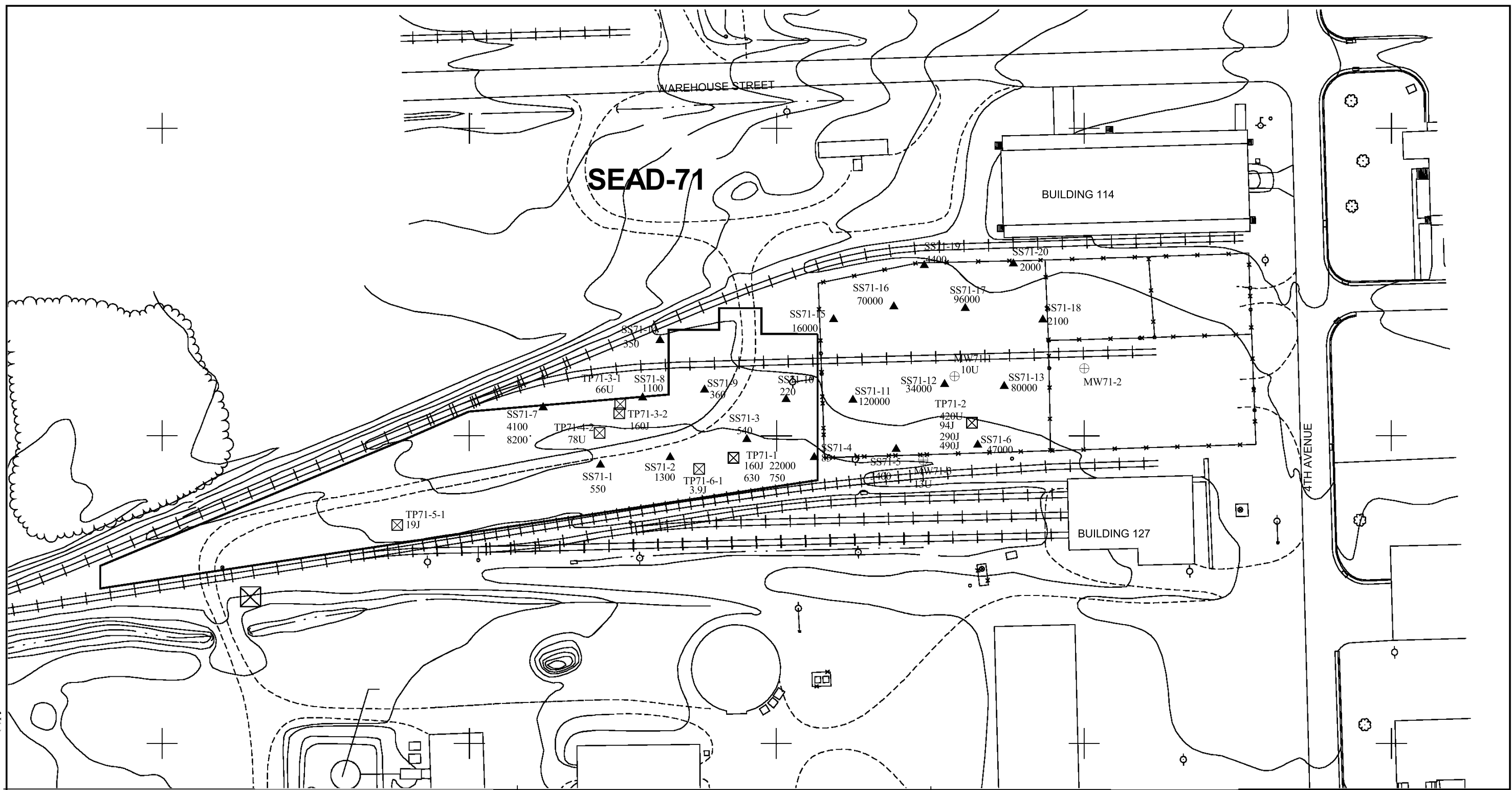

	Base Map Features
	Approximate Extent of 1997 GPR Survey
	ESI Test Pit Locations with Loc Id and Benzo[a]pyrene conc (ug/Kg)
	Monitoring Well Location with Loc Id and Benzo[a]pyrene conc (ug/Kg)
	Soil Boring/ Soil Sample Location with Loc Id and Benzo[a]pyrene conc (ug/Kg)

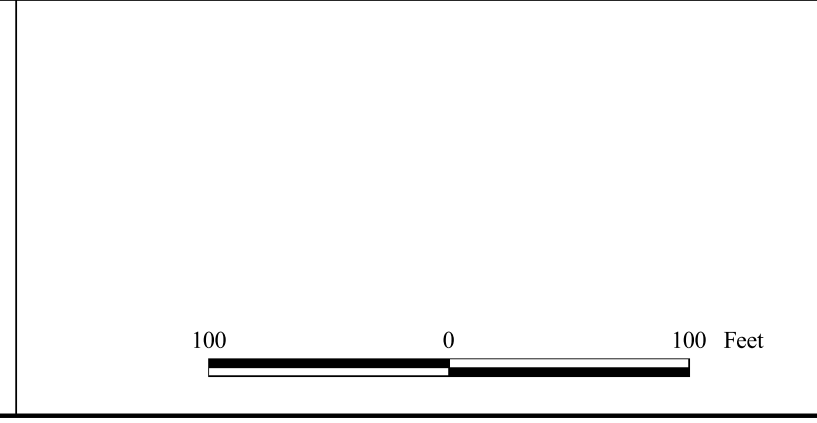

PARSONS	
SENECA ARMY DEPOT ACTIVITY SEAD-59 AND SEAD-71 PHASE II RI REPORT	
FIGURE 2-6 SEAD-71 PHASE I RI TOTAL BENZO[A]PYRENE CONCENTRATIONS IN SOIL	
April 2005	743519-03000

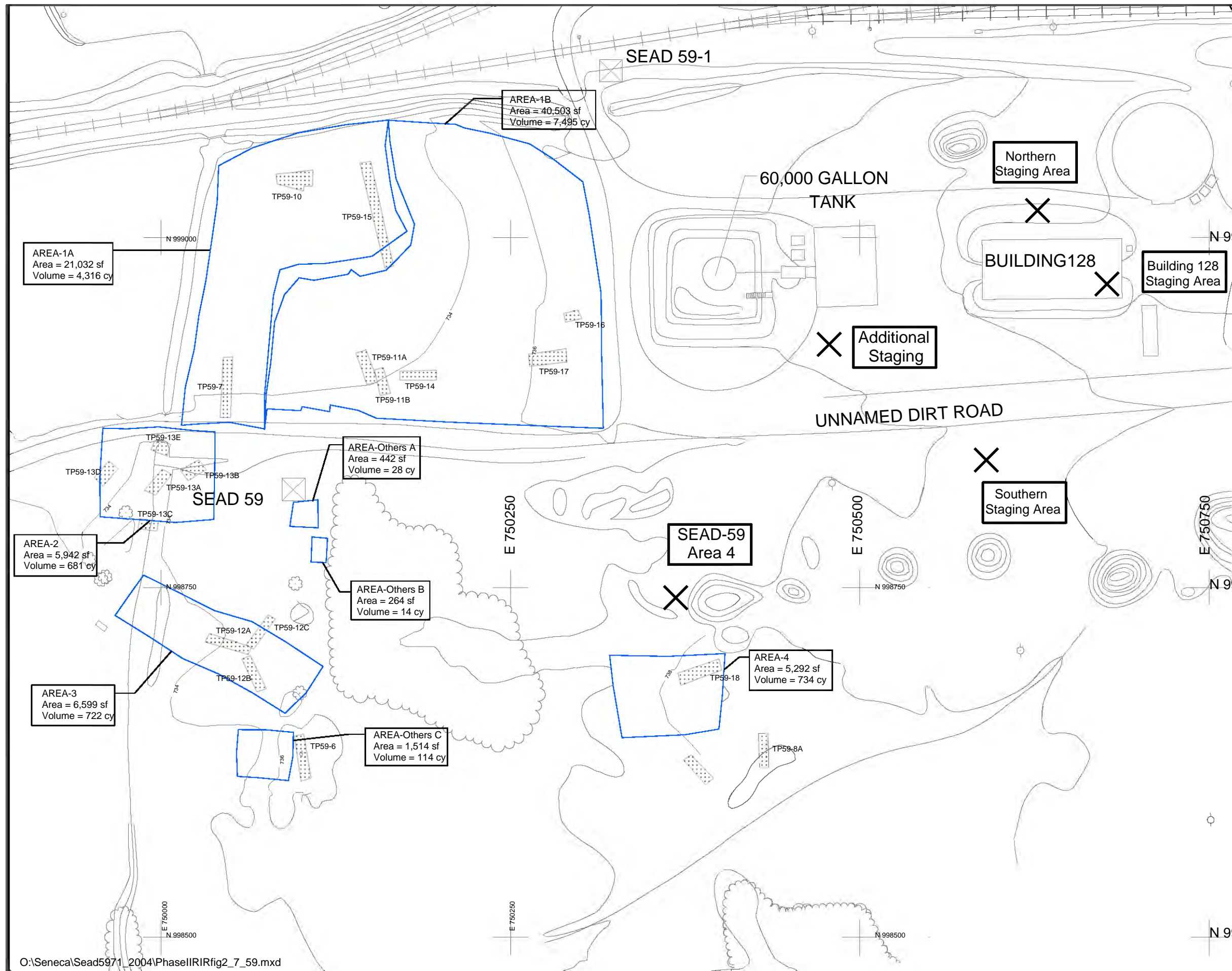

Legend:

- Base Map Feature
- Test Pit
- Test Pit Location
- Monitoring Well Location (installed during ESI)
- Monitoring Well Location (installed during TCRA)
- Soil Boring/Soil Sample Location
- Time-Critical Removal Action Confirmatory Sample Location
- TCRA Excavation Limit
- Contour
- Stockpile Staging Areas

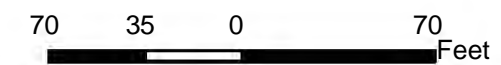

PARSONS

SENECA ARMY DEPOT ACTIVITY
SEAD-59 and SEAD-71 PHASE II
RI REPORT

FIGURE 2-7
SEAD-59
2002 TCRA EXCAVATED AREAS

April 2005

743519-03000

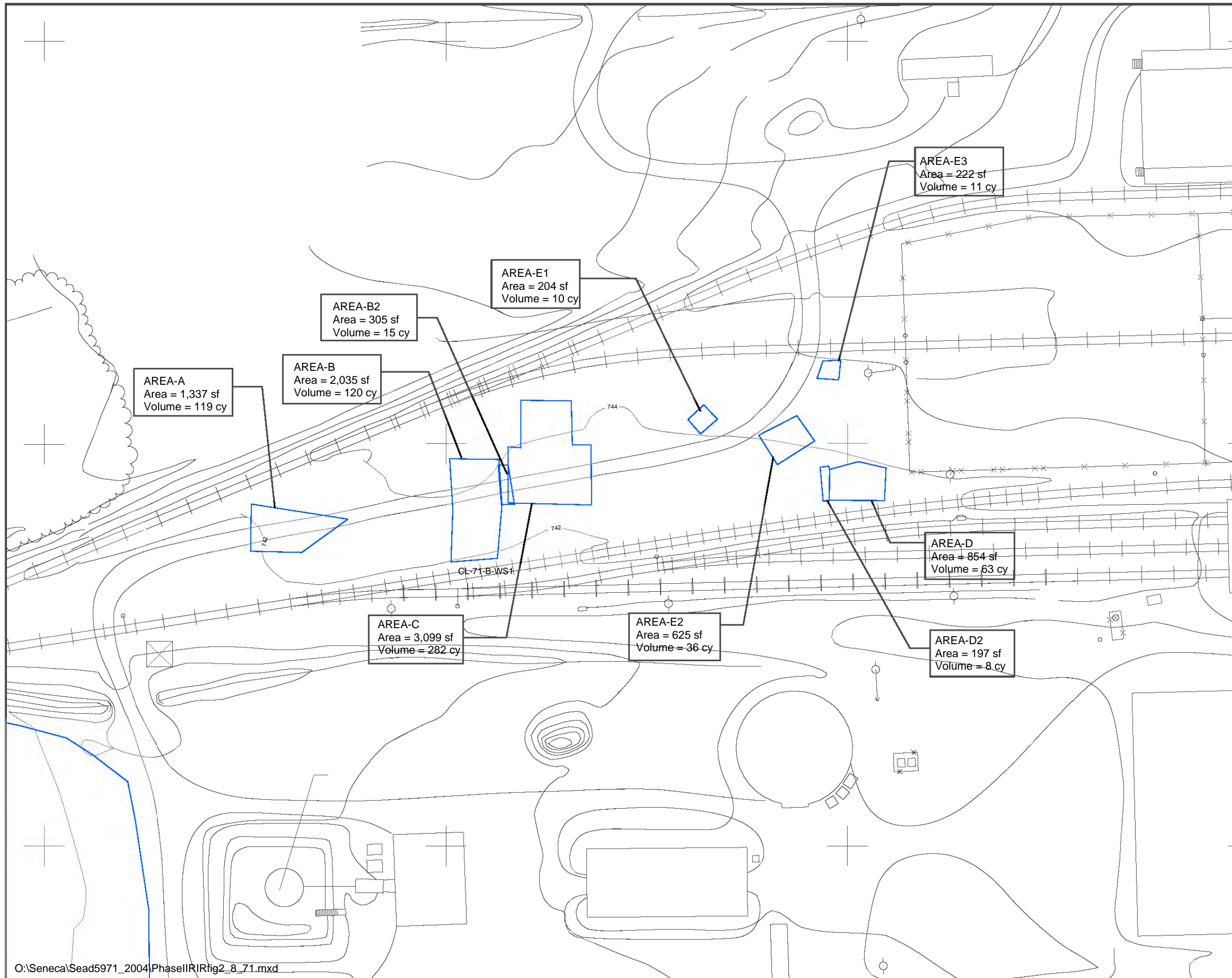

- Legend:**
- Base Map Feature
 - Test Pit Location
 - Monitoring Well Location (installed during ESI)
 - Monitoring Well Location (installed during TCRA)
 - Soil Boring/Soil Sample Location
 - TCRA Excavation Limit
 - Contour

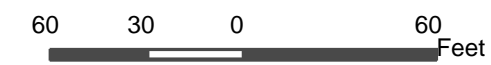





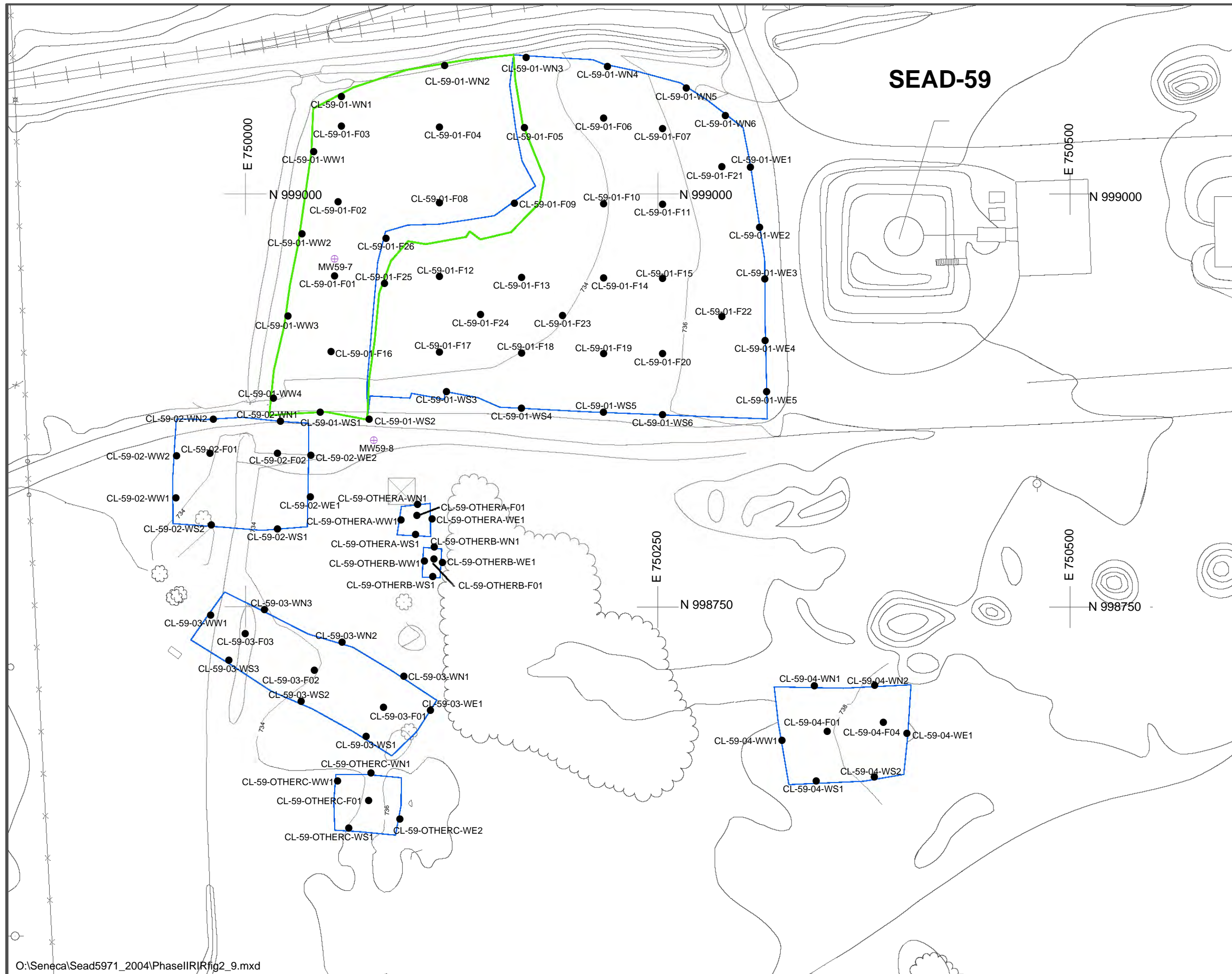

PARSONS

**SENECA ARMY DEPOT ACTIVITY
SEAD-59 AND SEAD-71 PHASE II
RI REPORT**

**FIGURE 2-8
SEAD-71
2002 TCRA EXCAVATED AREAS**



Legend:

-  Base Map Feature
-  Monitoring Well Location (installed during TCRA)
-  Time-Critical Removal Action Confirmatory Sample Location
-  TCRA Excavation Limit
-  TCRA Excavation Limit Area-1A
-  Contour

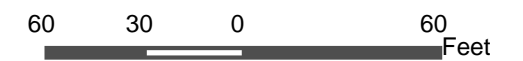

PARSONS

**SENECA ARMY DEPOT ACTIVITY
SEAD-59 AND SEAD-71 PHASE II
RI REPORT**

FIGURE 2-9



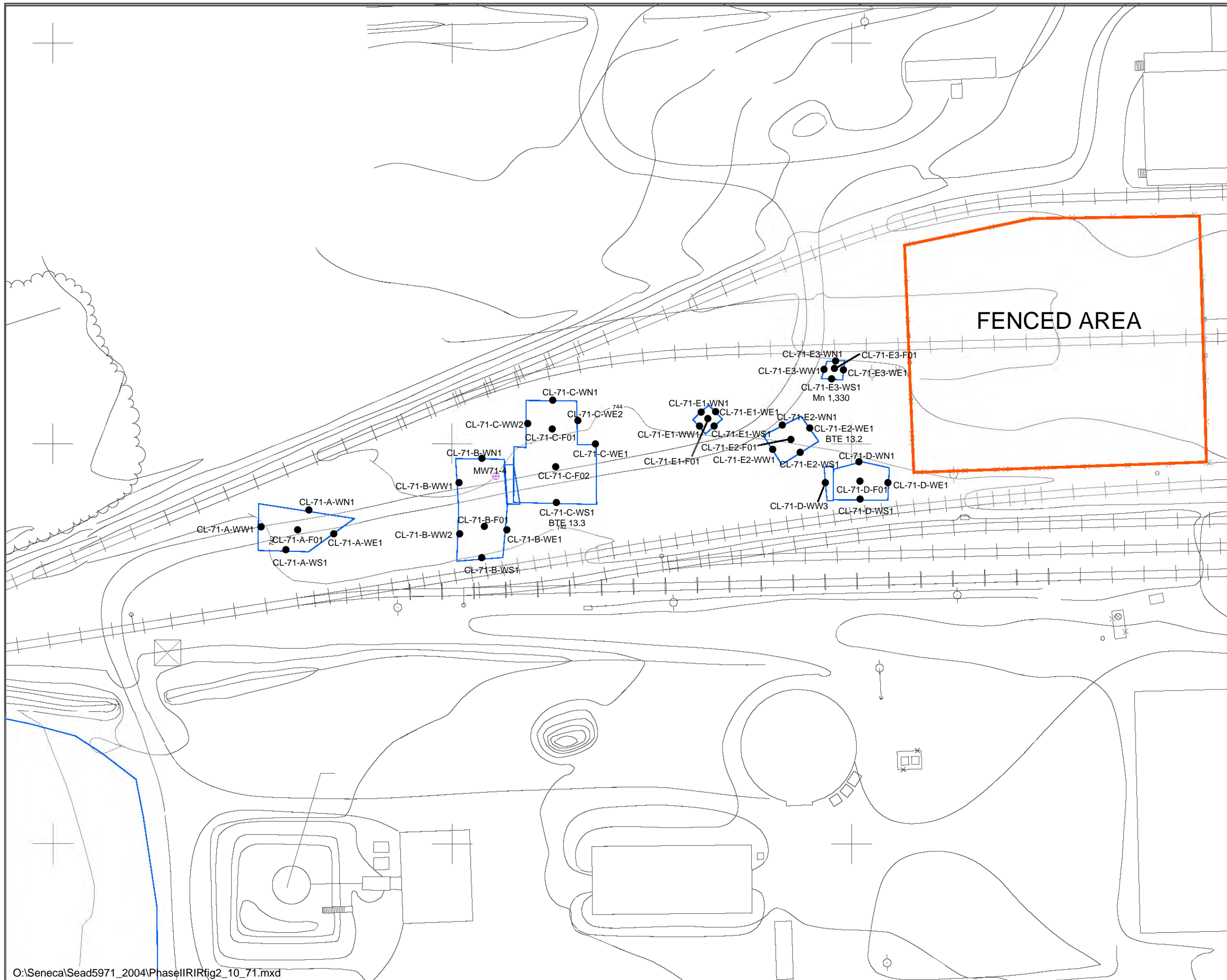

**SEAD-59
2002 TCRA CONFIRMATION SAMPLE
LOCATIONS**

April 2005

743519-03000



Legend:

-  Base Map Feature
-  Monitoring Well Location (installed during TCRA)
-  Time-Critical Removal Action Confirmatory Sample Location
-  TCRA Excavation Limit
-  Contour



PARSONS

**SENECA ARMY DEPOT ACTIVITY
SEAD-59 AND SEAD-71 PHASE II
RI REPORT
FIGURE 2-10**

**SEAD-71
2002 TCRA CONFIRMATORY
SAMPLE LOCATIONS**

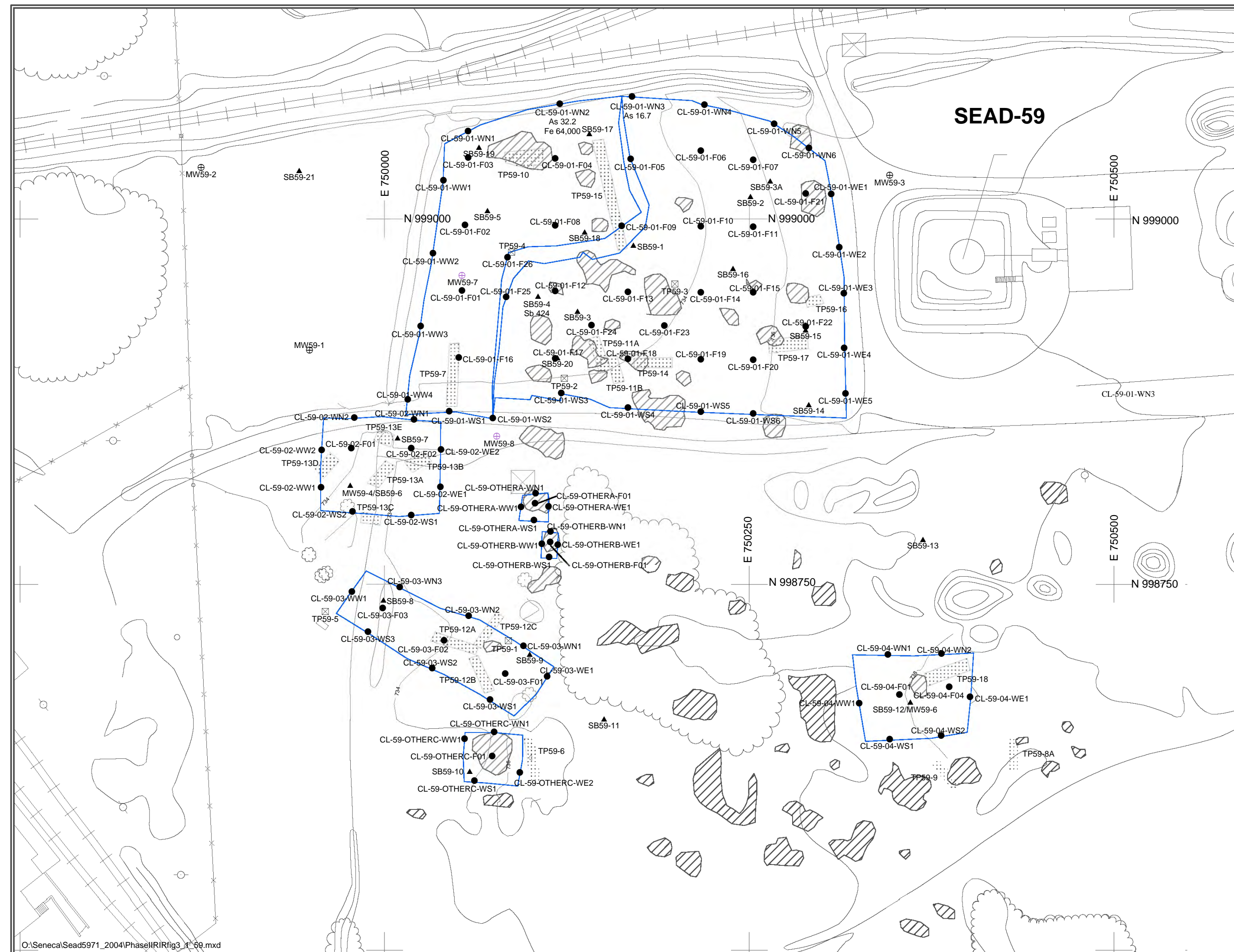

- Legend:**
- Base Map Feature
 - Test Pit
 - Test Pit Location
 - Monitoring Well Location (installed during ESI)
 - Monitoring Well Location (installed during TCRA)
 - Soil Boring/Soil Sample Location
 - Time-Critical Removal Action Confirmatory Sample Location
 - TCRA Excavation Limit
 - Contour

NOTE:
 1. Historical investigative sample locations and confirmatory sample locations excavated during the 2002 Time-Critical Removal Action are not shown in the figure.



PARSONS

**SENECA ARMY DEPOT ACTIVITY
 SEAD-59 AND SEAD-71 PHASE II
 RI REPORT**

**FIGURE 3-1
 CONFIRMATORY AND HISTORICAL
 SAMPLE LOCATIONS**

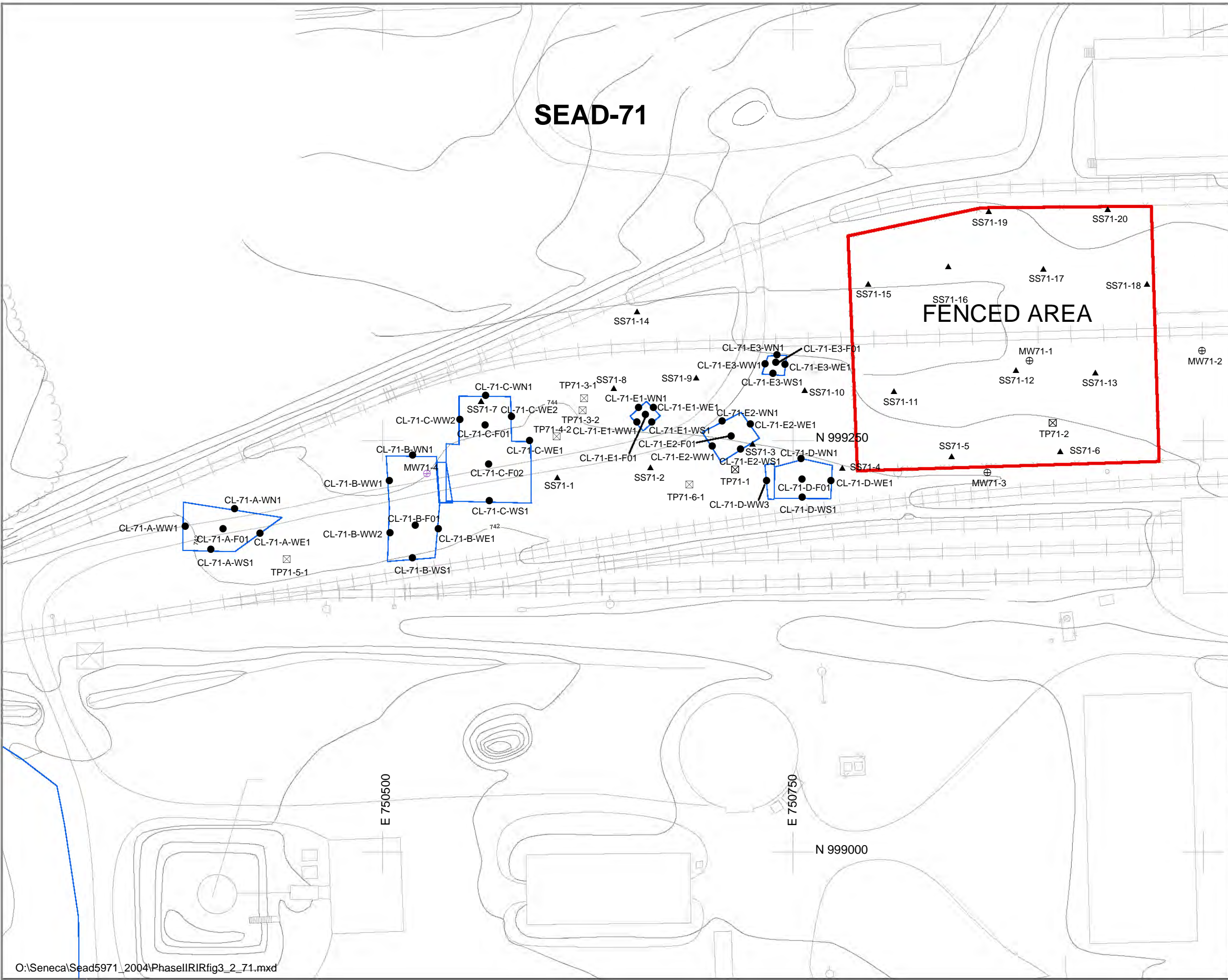

Legend:

- Base Map Feature
- Test Pit Location
- Monitoring Well Location (installed during ESI)
- Monitoring Well Location (installed during TCRA)
- Soil Boring/Soil Sample Location
- Time-Critical Removal Action Confirmatory Sample Location
- TCRA Excavation Limit
- Contour
- Fenced Area



NOTE:

1. Historical investigative sample locations and confirmatory sample locations excavated during the 2002 Time-Critical Removal Action are not shown in the figure.

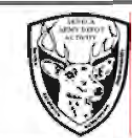
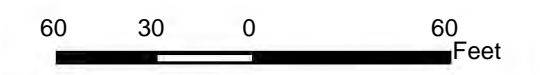

PARSONS

**SENECA ARMY DEPOT ACTIVITY
SEAD-59 AND SEAD-71 PHASE II
RI REPORT**

FIGURE 3-2

**SEAD-71
CONFIRMATORY AND HISTORICAL
SAMPLE LOCATIONS**

April 2005

743519-03000

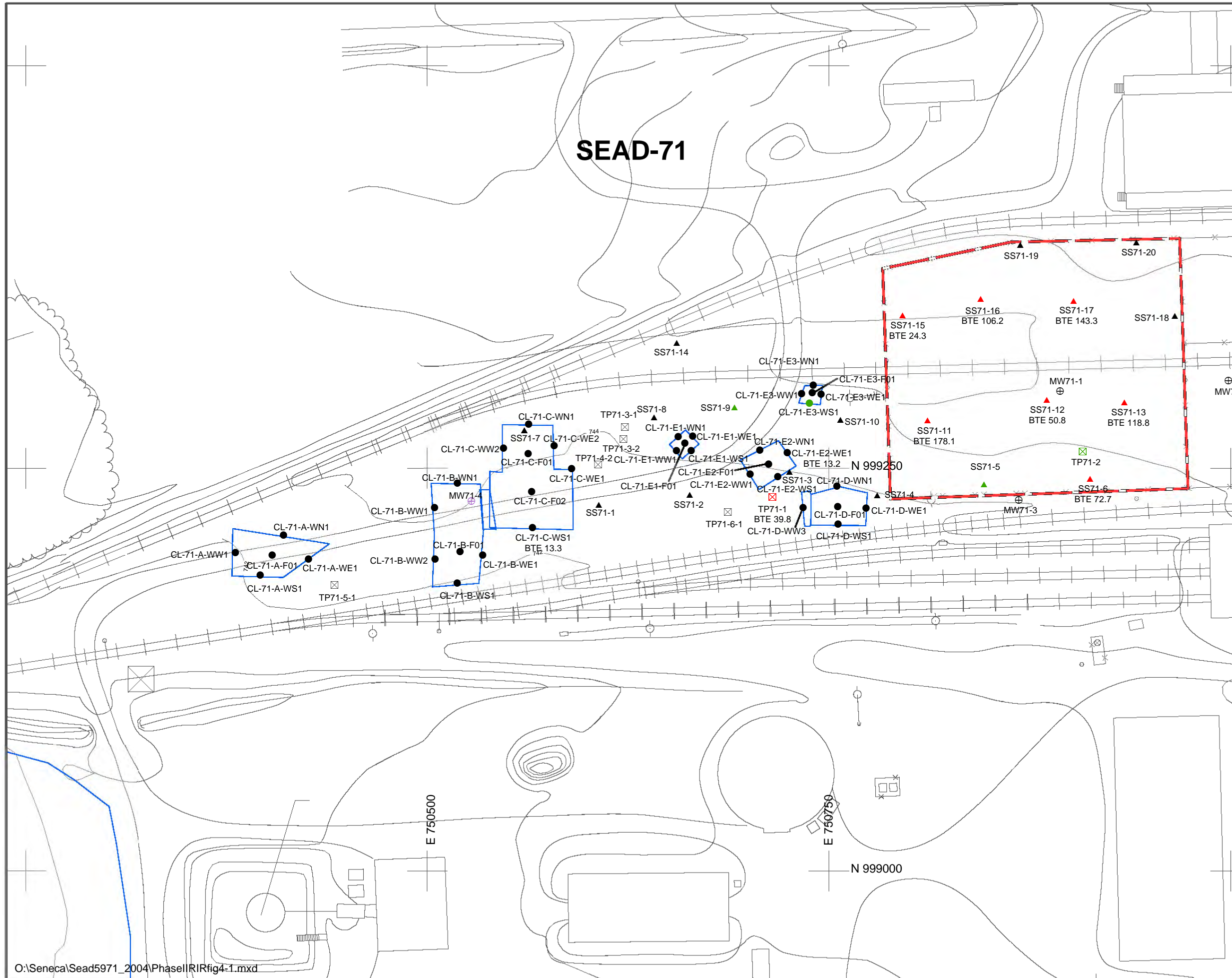

Legend:

- Base Map Feature
 - Test Pit Location
 - Monitoring Well Location (installed during ESI)
 - Monitoring Well Location (installed during TCRA)
 - Soil Boring/Soil Sample Location
 - Time-Critical Removal Action Confirmatory Sample Location
 - TCRA Excavation Limit
 - Contour
- Sample Location with Benz(a)pyrene Toxicity Equivalent Concentrations Greater Than 10 mg/kg BTE 178.1
- Benz(a)pyrene Toxicity Equivalent Concentrations (mg/kg)

NOTE:
 1. Historical investigative sample locations and confirmatory sample locations excavated during the 2002 Time-Critical Removal Action are not shown in the figure.

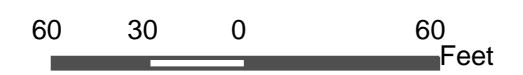

PARSONS

**SENECA ARMY DEPOT ACTIVITY
 SEAD-59 AND SEAD-71 PHASE II
 RI REPORT**

FIGURE 4-1

**SEAD-71
 BTE CONCENTRATIONS**

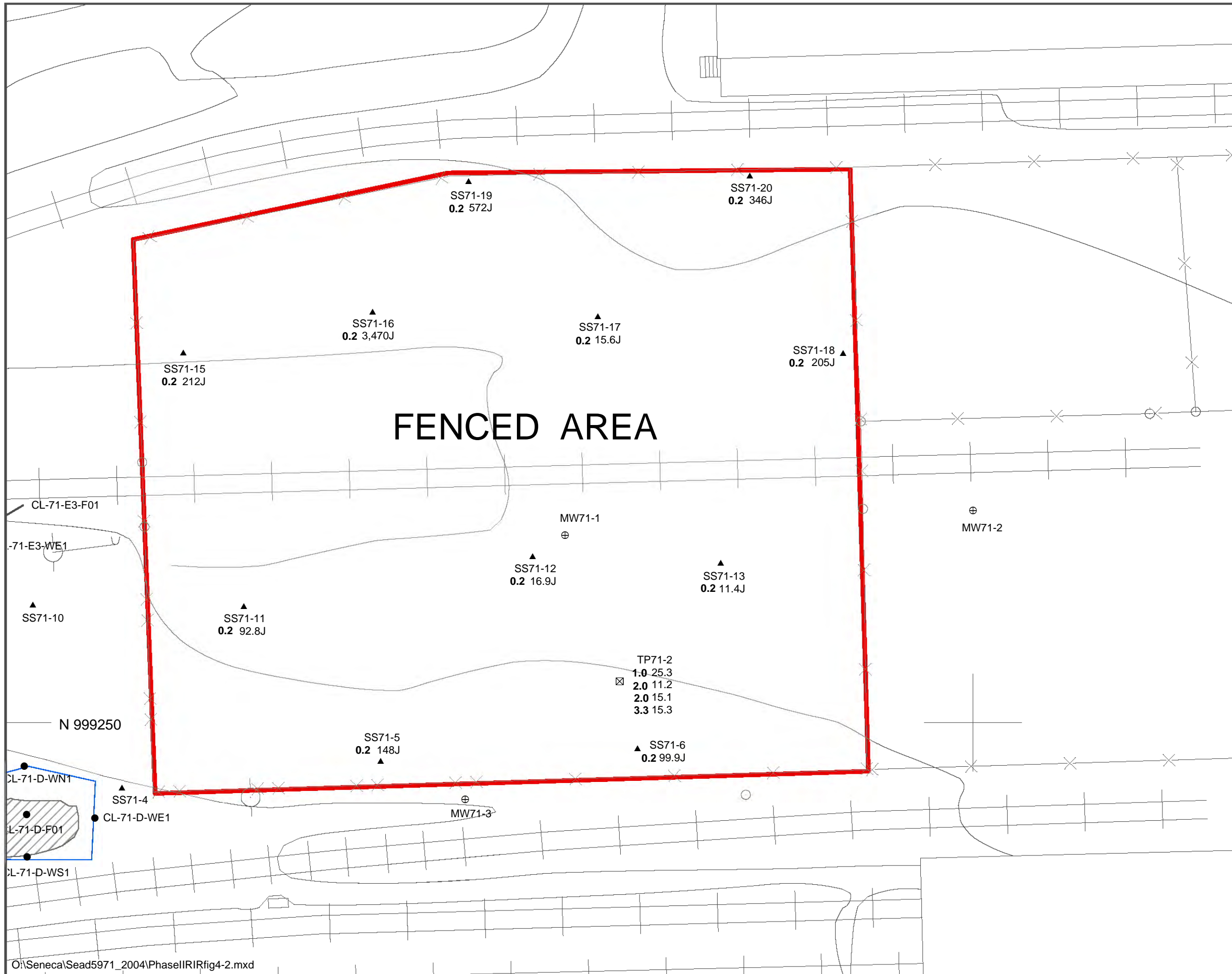

Legend:

- Base Map Feature
 - Test Pit Location
 - Monitoring Well Location (installed during ESI)
 - Monitoring Well Location (installed during TCRA)
 - Soil Boring/Soil Sample Location
 - Time-Critical Removal Action Confirmatory Sample Location
 - TCRA Excavation Limit
 - Contour
 - Suspected Location of GPR Anomaly
- } Sample Location and Lead Concentration
 SS71-5 }
 0.2 148J } Concentration (mg/kg)
 } Depth to Bottom of the Sample (ft)



NOTE:

- Historical investigative sample locations and confirmatory sample locations excavated during the 2002 Time-Critical Removal Action are not shown in the figure.



PARSONS

SENECA ARMY DEPOT ACTIVITY
SEAD-59 and SEAD-71
PHASE II RI REPORT

FIGURE 4-2

SEAD-71
FENCED AREA
LEAD CONCENTRATIONS

Figure 6-1
Conceptual Site Model for SEAD-59 and SEAD-71
SEAD-59 AND SEAD-71 PHASE II RI
Seneca Army Depot Activity

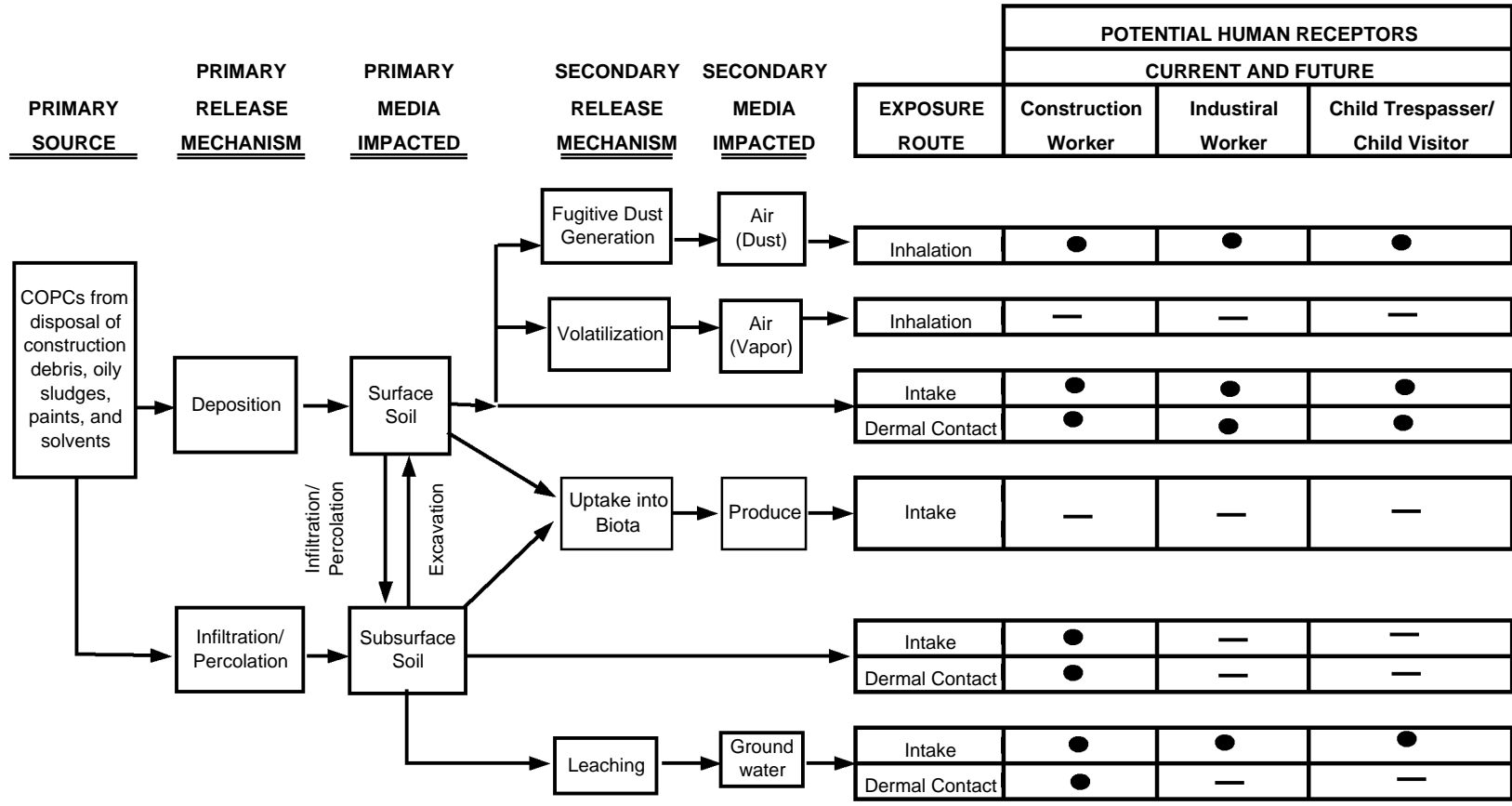

LEGEND
 → = Potential Pathways
 ● = Principal Pathways for quantitative evaluation
 — = Incomplete pathways

Figure 7-1 Screening Level Ecological Risk Assessment Process

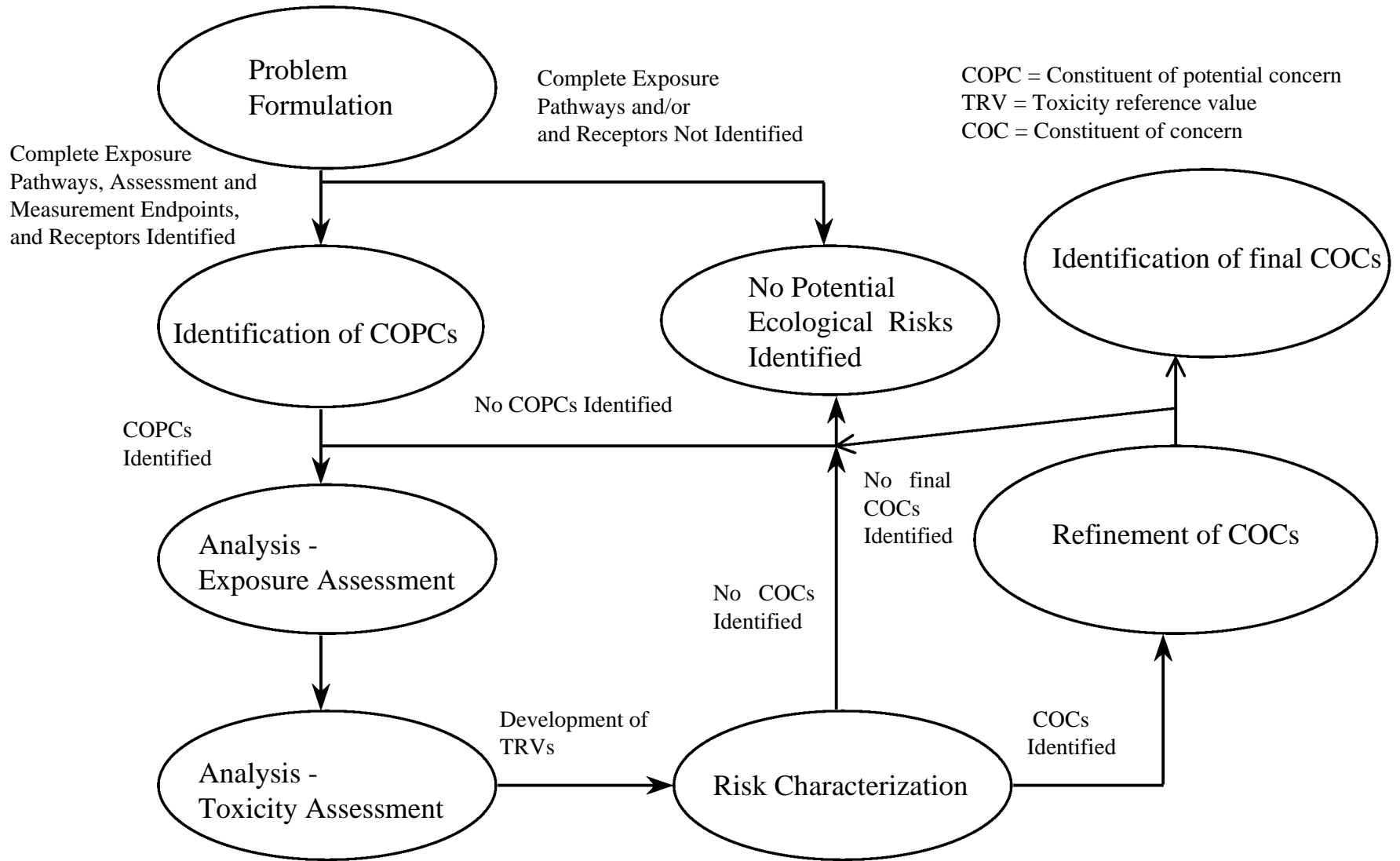
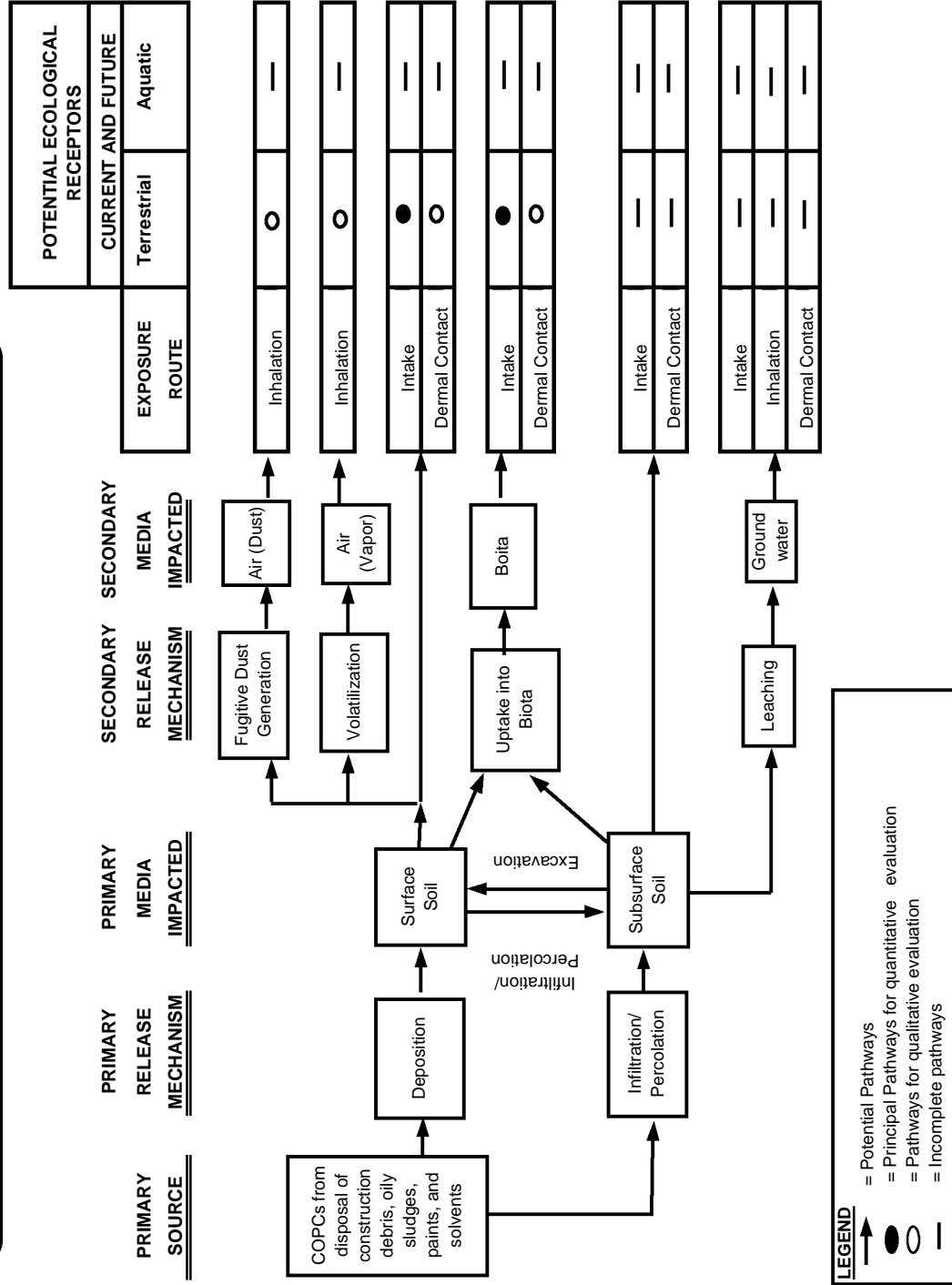

Figure 7-2
Conceptual Site Model for SEAD-59 and SEAD-71
SEAD-59 AND SEAD-71 PHASE II RI
Seneca Army Depot Activity



Appendix A

Analytical Data

A-1A	Sample Duplicate Merging Qualifiers
A-1B	SEAD-59 Soil Sample-Duplicate Merging Results
A-1C	SEAD-59 Stockpile Sample-Duplicate Merging Results
A-1D	SEAD-59 Groundwater Sample-Duplicate Merging Results
A-1E	SEAD-71 Groundwater Sample-Duplicate Merging Results
A-2A	SEAD-59 Surface Soil Sample Results (0-2 ft.)
A-2B	SEAD-59 Subsurface Soil Sample Results (2-15 ft.)
A-3	SEAD-59 Groundwater Sample Results
A-4A	SEAD-71 Surface Soil Sample Results (0-2 ft.)
A-4B	SEAD-71 Subsurface Soil Sample Results (2-15 ft.)
A-5	SEAD-71 Groundwater Sample Results
A-6	SEAD-59 Stockpile Soil Sample Results
A-7A	SEAD-59 Surface Soil (0-2 ft) Benzo(a)pyrene Toxicity Equivalency
A-7B	SEAD-59 Subsurface Soil (2-15 ft) Benzo(a)pyrene Toxicity Equivalency
A-8	SEAD-59 Stockpile Soil Benzo(a)pyrene Toxicity Equivalency
A-9A	SEAD-71 Surface Soil (0-2 ft) Benzo(a)pyrene Toxicity Equivalency
A-9B	SEAD-71 Subsurface Soil (2-15 ft) Benzo(a)pyrene Toxicity Equivalency
A-10A	SEAD-59 TCLP Soil Results
A-10B	SEAD-71 TCLP Soil Results
A-11A	SEAD-59 Soil TPH Data
A-11B	SEAD-71 Soil TPH Data
A-12	SEAD-59 ESI Groundwater TPH Data

Table A-1A
Sample Duplicate Merging of Qualifiers
SEAD-59 AND SEAD-71 PHASE II RI REPORT
Seneca Army Depot Activity

A Qualifier	B Qualifier		Averaged Qualifier
"NULL"	"NULL"		"NULL"
"NULL"	J		J
"NULL"	NJ		J
"NULL"	UJ		J
"NULL"	U		J
"NULL"	R		"NULL"
"NULL"	UR		"NULL"
"NULL"	JR		"NULL"
J	J		J
J	NJ		J
J	UJ		J
J	U		J
J	R		J
J	UR		J
J	JR		J
NJ	NJ		NJ
NJ	UJ		J
NJ	U		J
NJ	R		NJ
NJ	UR		NJ
NJ	JR		NJ
UJ	UJ		UJ
UJ	U		UJ
UJ	R		UJ
UJ	UR		UJ
UJ	JR		UJ
U	U		U
U	R		U
U	UR		U
U	JR		U
R	R		R
R	UR		R
R	JR		R
UR	UR		UR
UR	JR		JR
JR	JR		JR

List of Validated Qualifiers

- "NULL" detected concentration value
- J estimated detected concentration value
- NJ (JN) estimated detected concentration value but mass spectrum is less than 80% match
- UJ concentration detected at the detection limit and its presences is tentative
- U concentration not detected at or above this value; method detection limit
- R rejected value
- UR (RU) rejected value of concentration not detected, method detection limit
- JR (RJ) rejected estimated detected concentration

Comments

- J and NJ, J is assumed to be a conservative compared to NJ, which is an estimated detected concentration but the mass spectrum for the analyte is tentative and not a clear match.

Table A-1B
SEAD-59 Soil Sample-Duplicate Merged Results
SEAD-59 AND SEAD-71 PHASE II RI REPORT
Seneca Army Depot Activity

	Facility	SEAD-59	SEAD-59	SEAD-59	SEAD-59	SEAD-59	SEAD-59
	Location ID	FD-59-CL-01	CL-59-OTHERC-WN1	FD-59-CL-01/CL-59-OTHERC-WN1	FD-59-CL-02	CL-59-02-F02	FD-59-CL-02/CL-59-02-F02
	Maxtrix	SOIL	SOIL	SOIL	SOIL	SOIL	SOIL
	Sample ID	FD-59-CL-01	CL-59-OTHERC-WN1	FD-59-CL-01/CL-59-OTHERC-WN1	FD-59-CL-02	CL-59-02-F02	FD-59-CL-02/CL-59-02-F02
	Sample Date	5/6/2004	5/6/2004	5/6/2004	5/6/2004	5/6/2004	5/6/2004
	QC Code	SA	DU	SA/DU	SA	DU	SA/DU
	Study ID	ENSR IRM	ENSR IRM	ENSR IRM	ENSR IRM	ENSR IRM	ENSR IRM
Parameter	Units	Value (Q)	Value (Q)	Value (Q)	Value (Q)	Value (Q)	Value (Q)
Volatile Organic Compounds							
1,1,1-Trichloroethane	UG/KG	2.9 U	2.65 U	2.775 U	3 U	5 R	3 U
1,1,2,2-Tetrachloroethane	UG/KG	2.9 U	2.65 U	2.775 U	3 UJ	5 R	3 UJ
1,1,2-Trichloro-1,2,2-Trifluoroethane	UG/KG	2.9 U	2.65 U	2.775 U	3 U	5 R	3 U
1,1,2-Trichloroethane	UG/KG				3 U	5 R	3 U
1,1-Dichloroethane	UG/KG	2.9 U	2.65 U	2.775 U	3 U	5 R	3 U
1,1-Dichloroethene	UG/KG	2.9 U	2.65 U	2.775 U	3 U	5 R	3 U
1,2,3-Trichloropropane	UG/KG	2.9 U	2.65 U	2.775 U			
1,2,4-Trichlorobenzene	UG/KG	2.9 U	2.65 U	2.775 U	3 UJ	5 R	3 UJ
1,2-Dibromo-3-chloropropane	UG/KG				3 UJ	5 R	3 UJ
1,2-Dibromoethane	UG/KG				3 U	5 R	3 U
1,2-Dichlorobenzene	UG/KG	2.9 U	2.65 U	2.775 U	3 UJ	5 R	3 UJ
1,2-Dichloroethane	UG/KG	2.9 U	2.65 U	2.775 U	3 U	5 R	3 U
1,2-Dichloroethene (total)	UG/KG						
1,2-Dichloropropane	UG/KG				3 U	5 R	3 U
1,3-Dichlorobenzene	UG/KG	2.9 U	2.65 U	2.775 U	3 UJ	5 R	3 UJ
1,3-Dichloropropane	UG/KG	2.9 U	2.65 U	2.775 U			
1,4-Dichlorobenzene	UG/KG	2.9 U	2.65 U	2.775 U	3 UJ	5 R	3 UJ
Acetone	UG/KG	11.5 U	10.5 U	11 U	4.5 U	5 R	4.5 U
Benzene	UG/KG	2.9 U	2.65 U	2.775 U	3 U	5 R	3 U
Bromodichloromethane	UG/KG				3 U	5 R	3 U
Bromoform	UG/KG				3 UJ	5 R	3 UJ
Carbon disulfide	UG/KG	2.9 U	2.65 U	2.775 U	3 U	5 R	3 U
Carbon tetrachloride	UG/KG	2.9 U	2.65 U	2.775 U	3 U	5 R	3 U
Chlorobenzene	UG/KG	2.9 U	2.65 U	2.775 U	3 U	5 R	3 U
Chlorodibromomethane	UG/KG	2.9 U	2.65 U	2.775 U	3 U	5 R	3 U
Chloroethane	UG/KG	6 U	5.5 U	5.75 U	3 U	5 R	3 U
Chloroform	UG/KG	2.9 U	2.65 U	2.775 U	3 U	5 R	3 U
Cis-1,2-Dichloroethene	UG/KG				3 U	5 R	3 U
Cis-1,3-Dichloropropene	UG/KG				3 U	5 R	3 U
Cyclohexane	UG/KG				1 J	5 R	1 J
Dichlorodifluoromethane	UG/KG				3 U	5 R	3 U
Ethyl benzene	UG/KG	2.9 U	2.65 U	2.775 U	3 U	5 R	3 U
Isopropylbenzene	UG/KG				3 U	5 R	3 U
Meta/Para Xylene	UG/KG	2.9 U	2.65 U	2.775 U			
Methyl Acetate	UG/KG				3 U	5 R	3 U
Methyl Tertbutyl Ether	UG/KG				3 U	5 R	3 U
Methyl bromide	UG/KG				3 U	5 R	3 U
Methyl butyl ketone	UG/KG				3 U	5 R	3 U
Methyl chloride	UG/KG				3 U	5 R	3 U
Methyl cyclohexane	UG/KG				2 J	5 R	2 J
Methyl ethyl ketone	UG/KG	6 U	5.5 U	5.75 U	3 U	5 R	3 U
Methyl isobutyl ketone	UG/KG	6 U	5.5 U	5.75 U	3 U	5 R	3 U
Methylene chloride	UG/KG	2.9 U	2.65 U	2.775 U	3 U	5 R	3 U
Ortho Xylene	UG/KG	2.9 U	2.65 U	2.775 U			
Styrene	UG/KG				3 U	5 R	3 U
Tetrachloroethene	UG/KG	2.9 U	2.65 U	2.775 U	3 U	5 R	3 U
Toluene	UG/KG	2.9 U	2.65 U	2.775 U	1 J	5 R	1 J
Total BTEX	MG/KG						
Total Xylenes	UG/KG				1 J	5 R	1 J
Trans-1,2-Dichloroethene	UG/KG	2.9 U	2.65 U	2.775 U	3 U	5 R	3 U
Trans-1,3-Dichloropropene	UG/KG				3 U	5 R	3 U

Table A-1B
SEAD-59 Soil Sample-Duplicate Merged Results
SEAD-59 AND SEAD-71 PHASE II RI REPORT
Seneca Army Depot Activity

Parameter	Units	SEAD-59	SEAD-59	SEAD-59	SEAD-59	SEAD-59	SEAD-59
		Value (Q)	Value (Q)	Value (Q)	Value (Q)	Value (Q)	Value (Q)
Trichloroethene	UG/KG	2.9 U	2.65 U	2.775 U	3 U	5 R	3 U
Trichlorofluoromethane	UG/KG				3 U	5 R	3 U
Vinyl chloride	UG/KG	6 U	5.5 U	5.75 U	3 U	5 R	3 U
Semivolatile Organic Compounds							
1,1'-Biphenyl	UG/KG				185 U	190 U	187.5 U
1,2,4-Trichlorobenzene	UG/KG						
1,2-Dichlorobenzene	UG/KG						
1,3-Dichlorobenzene	UG/KG						
1,4-Dichlorobenzene	UG/KG						
2,2'-oxybis(1-Chloropropane)	UG/KG				185 U	190 U	187.5 U
2,4,5-Trichlorophenol	UG/KG	190 U	175 UJ	182.5 UJ	470 U	470 U	470 U
2,4,6-Trichlorophenol	UG/KG	190 U	175 UJ	182.5 UJ	185 U	190 U	187.5 U
2,4-Dichlorophenol	UG/KG	190 U	175 UJ	182.5 UJ	185 U	190 U	187.5 U
2,4-Dimethylphenol	UG/KG				185 U	190 U	187.5 U
2,4-Dinitrophenol	UG/KG	1000 U	900 UJ	950 UJ	470 UJ	470 UJ	470 UJ
2,4-Dinitrotoluene	UG/KG	190 U	175 UJ	182.5 UJ	185 U	190 U	187.5 U
2,6-Dinitrotoluene	UG/KG	190 U	175 UJ	182.5 UJ	185 U	190 U	187.5 U
2-Chloronaphthalene	UG/KG				185 U	190 U	187.5 U
2-Chlorophenol	UG/KG	190 U	175 UJ	182.5 UJ	185 U	190 U	187.5 U
2-Methylnaphthalene	UG/KG	190 U	175 UJ	182.5 UJ	185 U	190 U	187.5 U
2-Methylphenol	UG/KG	190 U	175 UJ	182.5 UJ	185 U	190 U	187.5 U
2-Nitroaniline	UG/KG	1000 U	900 UJ	950 UJ	470 U	470 U	470 U
2-Nitrophenol	UG/KG	190 U	175 UJ	182.5 UJ	185 U	190 U	187.5 U
3,3'-Dichlorobenzidine	UG/KG	190 U	175 UJ	182.5 UJ	185 U	190 U	187.5 U
3-Nitroaniline	UG/KG	1000 U	900 UJ	950 UJ	470 U	470 U	470 U
4,6-Dinitro-2-methylphenol	UG/KG				470 U	470 U	470 U
4-Bromophenyl phenyl ether	UG/KG				185 U	190 U	187.5 U
4-Chloro-3-methylphenol	UG/KG	190 U	175 UJ	182.5 UJ	185 U	190 U	187.5 U
4-Chloroaniline	UG/KG	190 U	175 UJ	182.5 UJ	185 UJ	190 UJ	187.5 UJ
4-Chlorophenyl phenyl ether	UG/KG				185 U	190 U	187.5 U
4-Methylphenol	UG/KG	190 U	175 UJ	182.5 UJ	185 U	190 U	187.5 U
4-Nitroaniline	UG/KG				470 UJ	470 UJ	470 UJ
4-Nitrophenol	UG/KG	1000 U	900 UJ	950 UJ	470 U	470 U	470 U
Acenaphthene	UG/KG	190 U	175 UJ	182.5 UJ	185 U	190 U	187.5 U
Acenaphthylene	UG/KG	43 J	175 UJ	109 J	185 U	190 U	187.5 U
Acetophenone	UG/KG				185 U	190 U	187.5 U
Aniline	UG/KG	190 U	175 UJ	182.5 UJ			
Anthracene	UG/KG	68 J	175 UJ	121.5 J	185 U	190 U	187.5 U
Atrazine	UG/KG				185 U	190 U	187.5 U
Benzaldehyde	UG/KG				185 UJ	190 UJ	187.5 UJ
Benzo(a)anthracene	UG/KG	190 J	130 J	160 J	185 U	190 U	187.5 U
Benzo(a)pyrene	UG/KG	180 J	130 J	155 J	185 U	190 U	187.5 U
Benzo(b)fluoranthene	UG/KG	160 J	120 J	140 J	185 U	190 U	187.5 U
Benzo(ghi)perylene	UG/KG	140 J	87 J	113.5 J	185 U	190 U	187.5 U
Benzo(k)fluoranthene	UG/KG	170 J	120 J	145 J	185 U	190 U	187.5 U
Benzoic Acid	UG/KG	1000 U	900 UJ	950 UJ			
Bis(2-Chloroethoxy)methane	UG/KG				185 U	190 U	187.5 U
Bis(2-Chloroethyl)ether	UG/KG				185 U	190 U	187.5 U
Bis(2-Chloroisopropyl)ether	UG/KG						
Bis(2-Ethylhexyl)phthalate	UG/KG	190 U	175 UJ	182.5 UJ	185 U	190 U	187.5 U
Butylbenzylphthalate	UG/KG	190 U	175 UJ	182.5 UJ	185 U	190 U	187.5 U
Caprolactam	UG/KG				185 U	190 U	187.5 U

Table A-1B
SEAD-59 Soil Sample-Duplicate Merged Results
SEAD-59 AND SEAD-71 PHASE II RI REPORT
Seneca Army Depot Activity

Parameter	Facility	SEAD-59	SEAD-59	SEAD-59	SEAD-59	SEAD-59	SEAD-59
	Location ID	FD-59-CL-01	CL-59-OTHERC-WN1	FD-59-CL-01/CL-59-OTHERC-WN1	FD-59-CL-02	CL-59-02-F02	FD-59-CL-02/CL-59-02-F02
	Matrix	SOIL	SOIL	SOIL	SOIL	SOIL	SOIL
	Sample ID	FD-59-CL-01	CL-59-OTHERC-WN1	FD-59-CL-01/CL-59-OTHERC-WN1	FD-59-CL-02	CL-59-02-F02	FD-59-CL-02/CL-59-02-F02
	Sample Date	5/6/2004	5/6/2004	5/6/2004	5/6/2004	5/6/2004	5/6/2004
	QC Code	SA	DU	SA/DU	SA	DU	SA/DU
	Study ID	ENSR IRM	ENSR IRM	ENSR IRM	ENSR IRM	ENSR IRM	ENSR IRM
	Units	Value (Q)	Value (Q)	Value (Q)	Value (Q)	Value (Q)	Value (Q)
Carbazole	UG/KG				185 U	190 U	187.5 U
Chrysene	UG/KG	210 J	170 J	190 J	185 U	190 U	187.5 U
Di-n-butylphthalate	UG/KG	190 U	175 UJ	182.5 UJ	185 U	190 U	187.5 U
Di-n-octylphthalate	UG/KG	190 U	175 UJ	182.5 UJ	185 U	190 U	187.5 U
Dibenz(a,h)anthracene	UG/KG	190 U	175 UJ	182.5 UJ	185 U	190 U	187.5 U
Dibenzofuran	UG/KG	190 U	175 UJ	182.5 UJ	185 U	190 U	187.5 U
Diethyl phthalate	UG/KG	190 U	175 UJ	182.5 UJ	185 U	190 U	187.5 U
Dimethylphthalate	UG/KG	190 U	175 UJ	182.5 UJ	185 U	190 U	187.5 U
Fluoranthene	UG/KG	350 J	140 J	245 J	185 U	190 U	187.5 U
Fluorene	UG/KG	190 U	175 UJ	182.5 UJ	185 U	190 U	187.5 U
Hexachlorobenzene	UG/KG	190 U	175 UJ	182.5 UJ	185 U	190 U	187.5 U
Hexachlorobutadiene	UG/KG	190 U	175 UJ	182.5 UJ	185 U	190 U	187.5 U
Hexachlorocyclopentadiene	UG/KG				185 U	190 U	187.5 U
Hexachloroethane	UG/KG	190 U	175 UJ	182.5 UJ	185 U	190 U	187.5 U
Indeno(1,2,3-cd)pyrene	UG/KG	130 J	75 J	102.5 J	185 U	190 U	187.5 U
Isophorone	UG/KG	190 U	175 UJ	182.5 UJ	185 U	190 U	187.5 U
N-Nitrosodiphenylamine	UG/KG				185 U	190 U	187.5 U
N-Nitrosodipropylamine	UG/KG				185 U	190 U	187.5 U
Naphthalene	UG/KG	190 U	175 UJ	182.5 UJ	185 U	190 U	187.5 U
Nitrobenzene	UG/KG	190 U	175 UJ	182.5 UJ	185 U	190 U	187.5 U
Pentachlorophenol	UG/KG	1000 U	900 UJ	950 UJ	470 U	470 U	470 U
Phenanthrene	UG/KG	180 J	58 J	119 J	185 U	190 U	187.5 U
Phenol	UG/KG	190 U	175 UJ	182.5 UJ	185 U	190 U	187.5 U
Pyrene	UG/KG	320 J	140 J	230 J	185 U	190 U	187.5 U
Pyridine	UG/KG	1000 U	900 UJ	950 UJ			
Total Unknown PAHs as SV	MG/KG						
Pesticides/PCBs							
4,4'-DDD	UG/KG	83 J	9 UJ	46 J	1.85 U	1.9 U	1.875 U
4,4'-DDE	UG/KG	35 J	9 U	22 J	1.85 U	1.9 U	1.875 U
4,4'-DDT	UG/KG	9.5 U	9 U	9.25 U	1.85 U	1.9 U	1.875 U
Aldrin	UG/KG	4.9 U	4.55 U	4.725 U	0.95 U	0.95 U	0.95 U
Alpha-BHC	UG/KG	4.9 U	4.55 U	4.725 U	0.95 U	0.95 U	0.95 U
Alpha-Chlordane	UG/KG	4.9 U	4.55 U	4.725 U	0.95 U	0.95 U	0.95 U
Beta-BHC	UG/KG	4.9 U	4.55 U	4.725 U	0.95 U	0.95 U	0.95 U
Delta-BHC	UG/KG	4.9 U	4.55 U	4.725 U	0.95 U	0.95 U	0.95 U
Dieldrin	UG/KG	9.5 U	9 U	9.25 U	1.85 U	1.9 U	1.875 U
Endosulfan I	UG/KG	4.9 U	4.55 U	4.725 U	0.95 U	0.95 U	0.95 U
Endosulfan II	UG/KG	9.5 U	9 U	9.25 U	1.85 U	1.9 U	1.875 U
Endosulfan sulfate	UG/KG	9.5 U	9 U	9.25 U	1.85 U	1.9 U	1.875 U
Endrin	UG/KG	9.5 U	9 U	9.25 U	1.85 U	1.9 U	1.875 U
Endrin aldehyde	UG/KG	9.5 U	9 U	9.25 U	1.85 U	1.9 U	1.875 U
Endrin ketone	UG/KG	9.5 U	9 U	9.25 U	1.85 U	1.9 U	1.875 U
Gamma-BHC/Lindane	UG/KG	4.9 U	4.55 U	4.725 U	0.95 U	0.95 U	0.95 U
Gamma-Chlordane	UG/KG	4.9 U	4.55 U	4.725 U	0.95 U	0.95 U	0.95 U
Heptachlor	UG/KG	4.9 U	4.55 U	4.725 U	0.95 U	0.95 U	0.95 U
Heptachlor epoxide	UG/KG	4.9 U	4.55 U	4.725 U	0.95 U	0.95 U	0.95 U
Methoxychlor	UG/KG	49 U	45.5 U	47.25 U	9.5 U	9.5 U	9.5 U
Toxaphene	UG/KG	95 U	90 U	92.5 U	95 UJ	95 UJ	95 UJ
Aroclor-1016	UG/KG	19 U	17.5 U	18.25 U	19 U	19 U	19 U
Aroclor-1221	UG/KG	19 U	17.5 U	18.25 U	19 U	19 U	19 U
Aroclor-1232	UG/KG	19 U	17.5 U	18.25 U	19 U	19 U	19 U
Aroclor-1242	UG/KG	19 U	17.5 U	18.25 U	19 U	19 U	19 U

Table A-1B
SEAD-59 Soil Sample-Duplicate Merged Results
SEAD-59 AND SEAD-71 PHASE II RI REPORT
Seneca Army Depot Activity

	Facility	SEAD-59	SEAD-59	SEAD-59	SEAD-59	SEAD-59	SEAD-59
	Location ID	FD-59-CL-01	CL-59-OTHERC-WN1	FD-59-CL-01/CL-59-OTHERC-WN1	FD-59-CL-02	CL-59-02-F02	FD-59-CL-02/CL-59-02-F02
	Maxtrix	SOIL	SOIL	SOIL	SOIL	SOIL	SOIL
	Sample ID	FD-59-CL-01	CL-59-OTHERC-WN1	FD-59-CL-01/CL-59-OTHERC-WN1	FD-59-CL-02	CL-59-02-F02	FD-59-CL-02/CL-59-02-F02
	Sample Date	5/6/2004	5/6/2004	5/6/2004	5/6/2004	5/6/2004	5/6/2004
	QC Code	SA	DU	SA/DU	SA	DU	SA/DU
	Study ID	ENSR IRM	ENSR IRM	ENSR IRM	ENSR IRM	ENSR IRM	ENSR IRM
Parameter	Units	Value (Q)	Value (Q)	Value (Q)	Value (Q)	Value (Q)	Value (Q)
Aroclor-1248	UG/KG	19 U	17.5 U	18.25 U	19 U	19 U	19 U
Aroclor-1254	UG/KG	19 U	17.5 U	18.25 U	19 U	19 U	19 U
Aroclor-1260	UG/KG	19 U	17.5 U	18.25 U	19 U	19 U	19 U
Metals and Cyanide							
Aluminum	MG/KG	12200	12900	12550	7650 J	7630 J	7640 J
Antimony	MG/KG	1.7 UJ	1.6 UJ	1.65 UJ	1.1 J	1.1 J	1.1 J
Arsenic	MG/KG	4.9	4.8	4.85	5.6 J	5.7 J	5.65 J
Barium	MG/KG	137	109	123	41.1 J	45.3 J	43.2 J
Beryllium	MG/KG	0.32	0.53	0.425	0.45	0.39	0.42
Cadmium	MG/KG	0.57	0.27 J	0.42 J	0.23 J	0.29	0.26 J
Calcium	MG/KG	10900	13100	12000	81400 J	31200 J	56300 J
Chromium	MG/KG	19	19.1	19.05	12.9 J	12.4 J	12.65 J
Cobalt	MG/KG	8.6	8.3	8.45	6.6 J	9.6 J	8.1 J
Copper	MG/KG	32 J	18.4 J	25.2 J	21.1 J	20.9 J	21 J
Cyanide	MG/KG						
Iron	MG/KG	21400 J	22200 J	21800 J	20800 J	18400 J	19600 J
Lead	MG/KG	69.1 J	23.1 J	46.1 J	9.4 J	10.9 J	10.15 J
Magnesium	MG/KG	4700	3880	4290	5190 J	13500 J	9345 J
Manganese	MG/KG	613 J	406 J	509.5 J	245 J	613 J	429 J
Mercury	MG/KG	0.16	0.1	0.13	0.44 J	0.06 J	0.25 J
Nickel	MG/KG	23	21.7	22.35	21.3 J	23.3 J	22.3 J
Potassium	MG/KG	1410	944	1177	908 J	863 J	885.5 J
Selenium	MG/KG	0.285 U	0.265 U	0.275 U	0.21 U	0.185 U	0.1975 U
Silver	MG/KG	0.285 U	0.265 U	0.275 U	0.56	1.4 J	0.98 J
Sodium	MG/KG	382 J	220 J	301 J	130 J	175 J	152.5 J
Thallium	MG/KG	0.63 J	0.62 J	0.625 J	0.105 U	0.09 U	0.0975 U
Vanadium	MG/KG	20.9	22.2	21.55	14.7 J	13.7 J	14.2 J
Zinc	MG/KG	181 J	71.7 J	126.35 J	70.5 J	76.6 J	73.55 J

Notes

- 1) Sample/Duplicate pairs were manually averaged.
- Averging Procedure below
- A - Non-Detects were half detection limit, R were ignored
- B - SA/DU chem values were then averaged
- C - SA/DU Qualifiers were selected to represent the discreet sample.
- D - SA/DU sample ID were combined and are marked with "SA/DU"

Table A-1B
SEAD-59 Soil Sample-Duplicate Merged Results
SEAD-59 AND SEAD-71 PHASE II RI REPORT
Seneca Army Depot Activity

	Facility Location ID	SEAD-59 FD-59-CL-05	SEAD-59 CL-59-01-WS1	SEAD-59 FD-59-CL-05/CL-59-01-WS1	SEAD-59 FD-59-CL-06	SEAD-59 CL-59-01-F10	SEAD-59 FD-59-CL-06/CL-59-01-F10	SEAD-59 FD-59-CL-3	SEAD-59 CL-59-01-WW4	SEAD-59 FD-59-CL-3/CL-59-01-WW4
	Maxitrix	SOIL	SOIL	SOIL	SOIL	SOIL	SOIL	SOIL	SOIL	SOIL
	Sample ID	FD-59-CL-05	CL-59-01-WS1	FD-59-CL-05/CL-59-01-WS1	FD-59-CL-06	CL-59-01-F10	FD-59-CL-06/CL-59-01-F10	FD-59-CL-3	CL-59-01-WW4	FD-59-CL-3/CL-59-01-WW4
	Sample Date	5/6/2004	5/6/2004	5/6/2004	5/6/2004	5/6/2004	5/6/2004	5/6/2004	5/6/2004	5/6/2004
	QC Code	SA	DU	SA/DU	SA	DU	SA/DU	SA	DU	SA/DU
	Study ID	ENSR IRM	ENSR IRM	ENSR IRM	ENSR IRM	ENSR IRM	ENSR IRM	ENSR IRM	ENSR IRM	ENSR IRM
Parameter	Units	Value (Q)	Value (Q)	Value (Q)	Value (Q)	Value (Q)	Value (Q)	Value (Q)	Value (Q)	Value (Q)
Volatile Organic Compounds										
1,1,1-Trichloroethane	UG/KG	3.1 U	2.95 U	3.025 U	2.5 U	6 R	2.5 U	2.5 U	2.5 U	2.5 U
1,1,2,2-Tetrachloroethane	UG/KG	3.1 U	2.95 U	3.025 U	2.5 U	6 R	2.5 U	2.5 UJ	5 R	2.5 UJ
1,1,2-Trichloro-1,2,2-Trifluoroethane	UG/KG	3.1 U	2.95 U	3.025 U	2.5 U	6 R	2.5 U	2.5 U	2.5 U	2.5 U
1,1,2-Trichloroethane	UG/KG				2.5 U	6 R	2.5 U	2.5 U	2.5 U	2.5 U
1,1-Dichloroethane	UG/KG	3.1 U	2.95 U	3.025 U	2.5 U	6 R	2.5 U	2.5 U	2.5 U	2.5 U
1,1-Dichloroethene	UG/KG	3.1 U	2.95 U	3.025 U	2.5 U	6 R	2.5 U	2.5 U	2.5 U	2.5 U
1,2,3-Trichloropropane	UG/KG	3.1 U	2.95 U	3.025 U						
1,2,4-Trichlorobenzene	UG/KG	3.1 U	2.95 U	3.025 U	2.5 U	6 R	2.5 U	2.5 UJ	5 R	2.5 UJ
1,2-Dibromo-3-chloropropane	UG/KG				2.5 U	6 R	2.5 U	2.5 UJ	5 R	2.5 UJ
1,2-Dibromoethane	UG/KG				2.5 U	6 R	2.5 U	2.5 U	2.5 UJ	2.5 UJ
1,2-Dichlorobenzene	UG/KG	3.1 U	2.95 U	3.025 U	2.5 U	6 R	2.5 U	2.5 UJ	5 R	2.5 UJ
1,2-Dichloroethane	UG/KG	3.1 U	2.95 U	3.025 U	2.5 U	6 R	2.5 U	2.5 U	2.5 U	2.5 U
1,2-Dichloroethene (total)	UG/KG				2.5 U	6 R	2.5 U	2.5 U	2.5 U	2.5 U
1,2-Dichloropropane	UG/KG				2.5 U	6 R	2.5 U	2.5 U	2.5 U	2.5 U
1,3-Dichlorobenzene	UG/KG	3.1 U	2.95 U	3.025 U	2.5 U	6 R	2.5 U	2.5 UJ	5 R	2.5 UJ
1,3-Dichloropropane	UG/KG	3.1 U	2.95 U	3.025 U						
1,4-Dichlorobenzene	UG/KG	3.1 U	2.95 U	3.025 U	2.5 U	6 R	2.5 U	2.5 UJ	5 R	2.5 UJ
Acetone	UG/KG	7.5 J	11.5 UJ	9.5 J	11 NJ	83 NJ	47 NJ	10	2.5 U	6.25 J
Benzene	UG/KG	3.1 U	2.95 U	3.025 U	2.5 U	6 R	2.5 U	2.5 U	2.5 U	2.5 U
Bromodichloromethane	UG/KG				2.5 U	6 R	2.5 U	2.5 U	2.5 U	2.5 U
Bromoform	UG/KG				2.5 U	6 R	2.5 U	2.5 U	2.5 UJ	2.5 UJ
Carbon disulfide	UG/KG	3.1 U	2.95 U	3.025 U	2.5 U	6 R	2.5 U	2.5 U	2.5 U	2.5 U
Carbon tetrachloride	UG/KG	3.1 U	2.95 U	3.025 U	2.5 U	6 R	2.5 U	2.5 U	2.5 U	2.5 U
Chlorobenzene	UG/KG	3.1 U	2.95 U	3.025 U	2.5 U	6 R	2.5 U	2.5 U	2.5 UJ	2.5 UJ
Chlorodibromomethane	UG/KG	3.1 U	2.95 U	3.025 U	2.5 U	6 R	2.5 U	2.5 U	2.5 UJ	2.5 UJ
Chloroethane	UG/KG	6 U	6 U	6 U	2.5 U	6 R	2.5 U	2.5 U	2.5 U	2.5 U
Chloroform	UG/KG	3.1 U	2.95 U	3.025 U	2.5 U	6 R	2.5 U	2.5 U	2.5 U	2.5 U
Cis-1,2-Dichloroethene	UG/KG				2.5 U	6 R	2.5 U	2.5 U	2.5 U	2.5 U
Cis-1,3-Dichloropropene	UG/KG				2.5 U	6 R	2.5 U	2.5 U	2.5 U	2.5 U
Cyclohexane	UG/KG				2.5 U	6 R	2.5 U	2.5 U	2.5 U	2.5 U
Dichlorodifluoromethane	UG/KG				2.5 U	6 R	2.5 U	2.5 U	2.5 UJ	2.5 UJ
Ethyl benzene	UG/KG	3.1 U	2.95 U	3.025 U	2.5 U	6 R	2.5 U	2.5 U	2.5 UJ	2.5 UJ
Isopropylbenzene	UG/KG				2.5 U	6 R	2.5 U	2.5 U	2.5 UJ	2.5 UJ
Meta/Para Xylene	UG/KG	3.1 U	2.95 U	3.025 U						
Methyl Acetate	UG/KG				2.5 U	6 R	2.5 U	2.5 U	2.5 U	2.5 U
Methyl Tertbutyl Ether	UG/KG				2.5 U	6 R	2.5 U	2.5 U	2.5 U	2.5 U
Methyl bromide	UG/KG				2.5 U	6 R	2.5 U	2.5 U	2.5 U	2.5 U
Methyl butyl ketone	UG/KG				2.5 U	6 R	2.5 U	2.5 U	2.5 UJ	2.5 UJ
Methyl chloride	UG/KG				2.5 U	6 R	2.5 U	2.5 U	2.5 U	2.5 U
Methyl cyclohexane	UG/KG				2.5 U	6 R	2.5 U	2.5 U	2.5 U	2.5 U
Methyl ethyl ketone	UG/KG	6 U	6 U	6 U	2.5 U	6 R	2.5 U	2.5 U	2.5 U	2.5 U
Methyl isobutyl ketone	UG/KG	6 U	6 U	6 U	2.5 U	6 R	2.5 U	2.5 U	2.5 U	2.5 U
Methylene chloride	UG/KG	3.1 U	2.95 U	3.025 U	2.5 U	3 U	2.75 U	2.5 U	3 U	2.75 U
Ortho Xylene	UG/KG	3.1 U	2.95 U	3.025 U						
Styrene	UG/KG				2.5 U	6 R	2.5 U	2.5 U	2.5 UJ	2.5 UJ
Tetrachloroethene	UG/KG	3.1 U	2.95 U	3.025 U	2.5 U	6 R	2.5 U	2.5 U	2.5 UJ	2.5 UJ
Toluene	UG/KG	3.1 U	2.95 U	3.025 U	2.5 U	6 R	2.5 U	2.5 U	2.5 U	2.5 U
Total BTEX	MG/KG									
Total Xylenes	UG/KG				2.5 U	6 R	2.5 U	2.5 UJ	5 R	2.5 UJ
Trans-1,2-Dichloroethene	UG/KG	3.1 U	2.95 U	3.025 U	2.5 U	6 R	2.5 U	2.5 U	2.5 U	2.5 U
Trans-1,3-Dichloropropene	UG/KG				2.5 U	6 R	2.5 U	2.5 U	2.5 U	2.5 U

Table A-1B
SEAD-59 Soil Sample-Duplicate Merged Results
SEAD-59 AND SEAD-71 PHASE II RI REPORT
Seneca Army Depot Activity

Facility Location ID	SEAD-59 FD-59-CL-05	SEAD-59 CL-59-01-WS1	SEAD-59 FD-59-CL-05/CL-59-01-WS1	SEAD-59 FD-59-CL-06	SEAD-59 CL-59-01-F10	SEAD-59 FD-59-CL-06/CL-59-01-F10	SEAD-59 FD-59-CL-3	SEAD-59 CL-59-01-WW4	SEAD-59 FD-59-CL-3/CL-59-01-WW4	
Matrix	SOIL	SOIL	SOIL	SOIL	SOIL	SOIL	SOIL	SOIL	SOIL	
Sample ID	FD-59-CL-05	CL-59-01-WS1	FD-59-CL-05/CL-59-01-WS1	FD-59-CL-06	CL-59-01-F10	FD-59-CL-06/CL-59-01-F10	FD-59-CL-3	CL-59-01-WW4	FD-59-CL-3/CL-59-01-WW4	
Sample Date	5/6/2004	5/6/2004	5/6/2004	5/6/2004	5/6/2004	5/6/2004	5/6/2004	5/6/2004	5/6/2004	
QC Code	SA	DU	SA/DU	SA	DU	SA/DU	SA	DU	SA/DU	
Study ID	ENSR IRM	ENSR IRM	ENSR IRM	ENSR IRM	ENSR IRM	ENSR IRM	ENSR IRM	ENSR IRM	ENSR IRM	
Parameter	Units	Value (Q)	Value (Q)	Value (Q)	Value (Q)	Value (Q)	Value (Q)	Value (Q)	Value (Q)	
Trichloroethene	UG/KG	3.1 U	2.95 U	3.025 U	2.5 U	6 R	2.5 U	2.5 U	2.5 U	
Trichlorofluoromethane	UG/KG				2.5 U	6 R	2.5 U	2.5 U	2.5 U	
Vinyl chloride	UG/KG	6 U	6 U	6 U	2.5 U	6 R	2.5 U	2.5 U	2.5 U	
Semivolatile Organic Compounds										
1,1'-Biphenyl	UG/KG				180 U	195 U	187.5 U	185 U	185 U	185 U
1,2,4-Trichlorobenzene	UG/KG									
1,2-Dichlorobenzene	UG/KG									
1,3-Dichlorobenzene	UG/KG									
1,4-Dichlorobenzene	UG/KG									
2,2'-oxybis(1-Chloropropane)	UG/KG				180 UJ	195 UJ	187.5 UJ	185 U	185 U	185 U
2,4,5-Trichlorophenol	UG/KG	205 U	195 U	200 U	455 U	485 U	470 U	460 U	460 U	460 U
2,4,6-Trichlorophenol	UG/KG	205 U	195 U	200 U	180 U	195 U	187.5 U	185 U	185 U	185 U
2,4-Dichlorophenol	UG/KG	205 U	195 U	200 U	180 U	195 U	187.5 U	185 U	185 U	185 U
2,4-Dimethylphenol	UG/KG				180 U	195 U	187.5 U	185 U	185 U	185 U
2,4-Dinitrophenol	UG/KG	1050 U	1000 U	1025 U	455 U	485 U	470 U	460 U	460 U	460 U
2,4-Dinitrotoluene	UG/KG	205 U	195 U	200 U	180 U	195 U	187.5 U	185 U	185 U	185 U
2,6-Dinitrotoluene	UG/KG	205 U	195 U	200 U	180 U	195 U	187.5 U	185 U	185 U	185 U
2-Chloronaphthalene	UG/KG				180 U	195 U	187.5 U	185 U	185 U	185 U
2-Chlorophenol	UG/KG	205 U	195 U	200 U	180 U	195 U	187.5 U	185 U	185 U	185 U
2-Methylnaphthalene	UG/KG	205 U	195 U	200 U	180 U	195 U	187.5 U	185 U	185 U	185 U
2-Methylphenol	UG/KG	205 U	195 U	200 U	180 U	195 U	187.5 U	185 U	185 U	185 U
2-Nitroaniline	UG/KG	1050 U	1000 U	1025 U	455 U	485 U	470 U	460 U	460 U	460 U
2-Nitrophenol	UG/KG	205 U	195 U	200 U	180 U	195 U	187.5 U	185 U	185 U	185 U
3,3'-Dichlorobenzidine	UG/KG	205 U	195 U	200 U	180 UJ	195 UJ	187.5 UJ	185 U	185 U	185 U
3-Nitroaniline	UG/KG	1050 U	1000 U	1025 U	455 U	485 U	470 U	460 U	460 U	460 U
4,6-Dinitro-2-methylphenol	UG/KG				455 U	485 U	470 U	460 U	460 U	460 U
4-Bromophenyl phenyl ether	UG/KG				180 U	195 U	187.5 U	185 U	185 U	185 U
4-Chloro-3-methylphenol	UG/KG	205 U	195 U	200 U	180 U	195 U	187.5 U	185 U	185 U	185 U
4-Chloroaniline	UG/KG	205 U	195 U	200 U	180 U	195 U	187.5 U	185 U	185 U	185 U
4-Chlorophenyl phenyl ether	UG/KG				180 U	195 U	187.5 U	185 U	185 U	185 U
4-Methylphenol	UG/KG	205 U	195 U	200 U	180 U	195 U	187.5 U	185 U	185 U	185 U
4-Nitroaniline	UG/KG				455 U	485 U	470 U	460 U	460 U	460 U
4-Nitrophenol	UG/KG	1050 U	1000 U	1025 U	455 U	485 U	470 U	460 U	460 U	460 U
Acenaphthene	UG/KG	205 U	195 U	200 U	180 U	195 U	187.5 U	185 U	185 U	185 U
Acenaphthylene	UG/KG	46 J	195 U	120.5 J	180 U	195 U	187.5 U	185 U	35 J	110 J
Acetophenone	UG/KG				180 U	195 U	187.5 U	185 U	185 U	185 U
Aniline	UG/KG	205 U	195 U	200 U						
Anthracene	UG/KG	205 U	195 U	200 U	180 U	195 U	187.5 U	185 U	92 J	138.5 J
Atrazine	UG/KG				180 U	195 U	187.5 U	185 U	185 U	185 U
Benzaldehyde	UG/KG				180 U	195 U	187.5 U	185 U	185 U	185 U
Benzo(a)anthracene	UG/KG	150 J	195 U	172.5 J	180 U	195 U	187.5 U	185 U	210 J	197.5 J
Benzo(a)pyrene	UG/KG	180 J	195 U	187.5 J	180 U	195 U	187.5 U	185 U	220 J	202.5 J
Benzo(b)fluoranthene	UG/KG	120 J	195 U	157.5 J	180 U	195 U	187.5 U	185 U	280 J	232.5 J
Benzo(ghi)perylene	UG/KG	110 J	195 U	152.5 J	180 U	195 U	187.5 U	185 U	130 J	157.5 J
Benzo(k)fluoranthene	UG/KG	130 J	195 U	162.5 J	180 U	195 U	187.5 U	185 U	100 J	142.5 J
Benzoic Acid	UG/KG	1050 U	1000 U	1025 U						
Bis(2-Chloroethoxy)methane	UG/KG				180 U	195 U	187.5 U	185 U	185 U	185 U
Bis(2-Chloroethyl)ether	UG/KG				180 U	195 U	187.5 U	185 U	185 U	185 U
Bis(2-Chloroisopropyl)ether	UG/KG									
Bis(2-Ethylhexyl)phthalate	UG/KG	205 U	195 U	200 U	180 U	195 U	187.5 U	19 J	185 U	102 J
Butylbenzylphthalate	UG/KG	205 U	195 U	200 U	180 U	195 U	187.5 U	185 U	185 U	185 U
Caprolactam	UG/KG				180 U	195 U	187.5 U	185 U	185 U	185 U

Table A-1B
SEAD-59 Soil Sample-Duplicate Merged Results
SEAD-59 AND SEAD-71 PHASE II RI REPORT
Seneca Army Depot Activity

Facility Location ID	SEAD-59 FD-59-CL-05	SEAD-59 CL-59-01-WS1	SEAD-59 FD-59-CL-05/CL-59-01-WS1	SEAD-59 FD-59-CL-06	SEAD-59 CL-59-01-F10	SEAD-59 FD-59-CL-06/CL-59-01-F10	SEAD-59 FD-59-CL-3	SEAD-59 CL-59-01-WW4	SEAD-59 FD-59-CL-3/CL-59-01-WW4	
Matrix	SOIL	SOIL	SOIL	SOIL	SOIL	SOIL	SOIL	SOIL	SOIL	
Sample ID	FD-59-CL-05	CL-59-01-WS1	FD-59-CL-05/CL-59-01-WS1	FD-59-CL-06	CL-59-01-F10	FD-59-CL-06/CL-59-01-F10	FD-59-CL-3	CL-59-01-WW4	FD-59-CL-3/CL-59-01-WW4	
Sample Date	5/6/2004	5/6/2004	5/6/2004	5/6/2004	5/6/2004	5/6/2004	5/6/2004	5/6/2004	5/6/2004	
QC Code	SA	DU	SA/DU	SA	DU	SA/DU	SA	DU	SA/DU	
Study ID	ENSR IRM	ENSR IRM	ENSR IRM	ENSR IRM	ENSR IRM	ENSR IRM	ENSR IRM	ENSR IRM	ENSR IRM	
Parameter	Units	Value (Q)	Value (Q)	Value (Q)	Value (Q)	Value (Q)	Value (Q)	Value (Q)	Value (Q)	
Carbazole	UG/KG			180 U	180 U	187.5 U	185 U	57 J	121 J	
Chrysene	UG/KG	150 J	195 U	172.5 J	180 U	187.5 U	185 U	230 NJ	207.5 NJ	
Di-n-butylphthalate	UG/KG		195 U	195 U	180 U	195 U	187.5 U	185 U	185 U	
Di-n-octylphthalate	UG/KG	205 U	195 U	200 U	180 U	195 U	187.5 U	185 U	185 U	
Dibenz(a,h)anthracene	UG/KG	44 J	195 U	119.5 J	180 U	195 U	187.5 U	185 U	32 NJ	
Dibenzofuran	UG/KG	205 U	195 U	200 U	180 U	195 U	187.5 U	185 U	185 U	
Diethyl phthalate	UG/KG	205 U	195 U	200 U	180 U	195 U	187.5 U	185 U	185 U	
Dimethylphthalate	UG/KG	205 U	195 U	200 U	180 U	195 U	187.5 U	185 U	185 U	
Fluoranthene	UG/KG	200 J	195 U	197.5 J	180 U	195 U	187.5 U	185 U	530	
Fluorene	UG/KG	205 U	195 U	200 U	180 U	195 U	187.5 U	185 U	30 J	
Hexachlorobenzene	UG/KG	205 U	195 U	200 U	180 U	195 U	187.5 U	185 U	185 U	
Hexachlorobutadiene	UG/KG	205 U	195 U	200 U	180 U	195 U	187.5 U	185 U	185 U	
Hexachlorocyclopentadiene	UG/KG			180 U	195 U	187.5 U	185 U	185 U	185 U	
Hexachloroethane	UG/KG	205 U	195 U	200 U	180 U	195 U	187.5 U	185 U	185 U	
Indeno(1,2,3-cd)pyrene	UG/KG	100 J	195 U	147.5 J	180 U	195 U	187.5 U	185 U	130 J	
Isophorone	UG/KG	205 U	195 U	200 U	180 U	195 U	187.5 U	185 U	185 U	
N-Nitrosodiphenylamine	UG/KG			180 U	195 U	187.5 U	185 U	185 U	185 U	
N-Nitrosodipropylamine	UG/KG			180 U	195 U	187.5 U	185 U	185 U	185 U	
Naphthalene	UG/KG	205 U	195 U	200 U	180 U	195 U	187.5 U	185 U	185 U	
Nitrobenzene	UG/KG	205 U	195 U	200 U	180 U	195 U	187.5 U	185 U	185 U	
Pentachlorophenol	UG/KG	1050 U	1000 U	1025 U	455 U	485 U	470 U	460 U	460 U	
Phenanthrene	UG/KG	79 J	195 U	137 J	180 U	195 U	187.5 U	185 U	370	
Phenol	UG/KG	205 U	195 U	200 U	180 U	195 U	187.5 U	185 U	185 U	
Pyrene	UG/KG	200 J	195 U	197.5 J	180 U	195 U	187.5 U	185 U	500	
Pyridine	UG/KG	1050 U	1000 U	1025 U	180 U	195 U	187.5 U		342.5 J	
Total Unknown PAHs as SV	MG/KG									
Pesticides/PCBs										
4,4'-DDD	UG/KG	10 U	9.5 U	9.75 U	1.8 U	1.9 U	1.85 U	1.85 U	1.85 U	
4,4'-DDE	UG/KG	10 U	9.5 U	9.75 U	1.8 U	1.9 U	1.85 U	1.85 UJ	16 NJ	
4,4'-DDT	UG/KG	10 U	9.5 U	9.75 U	1.8 U	1.9 U	1.85 U	1.85 U	10 J	
Aldrin	UG/KG	5 U	5 U	5 U	0.95 U	1 U	0.975 U	0.95 U	0.95 U	
Alpha-BHC	UG/KG	5 U	5 U	5 U	0.95 U	1 U	0.975 U	0.95 U	0.95 U	
Alpha-Chlordane	UG/KG	5 U	5 U	5 U	0.95 U	1 U	0.975 U	0.95 U	0.95 U	
Beta-BHC	UG/KG	5 U	5 U	5 U	0.95 U	1 U	0.975 U	0.95 U	0.95 U	
Delta-BHC	UG/KG	5 U	5 U	5 U	0.95 U	1 U	0.975 U	0.95 U	0.95 U	
Dieldrin	UG/KG	10 U	9.5 U	9.75 U	1.8 U	1.9 U	1.85 U	1.85 U	1.85 U	
Endosulfan I	UG/KG	5 U	5 U	5 U	0.95 U	1 U	0.975 U	0.95 U	0.95 U	
Endosulfan II	UG/KG	10 U	9.5 U	9.75 U	1.8 U	1.9 U	1.85 U	1.85 U	1.85 U	
Endosulfan sulfate	UG/KG	10 U	9.5 U	9.75 U	1.8 U	1.9 U	1.85 U	1.85 U	1.85 U	
Endrin	UG/KG	10 U	9.5 U	9.75 U	1.8 U	1.9 U	1.85 U	1.85 U	5.8 NJ	
Endrin aldehyde	UG/KG	10 U	9.5 U	9.75 U	1.8 U	1.9 U	1.85 U	1.85 U	1.85 U	
Endrin ketone	UG/KG	10 U	9.5 U	9.75 U	1.8 U	1.9 U	1.85 U	1.85 U	1.85 U	
Gamma-BHC/Lindane	UG/KG	5 U	5 U	5 U	0.95 U	1 U	0.975 U	0.95 U	0.95 U	
Gamma-Chlordane	UG/KG	5 U	5 U	5 U	0.95 UJ	1 UJ	0.975 UJ	0.95 U	0.95 U	
Heptachlor	UG/KG	5 U	5 U	5 U	0.95 U	1 U	0.975 U	0.95 U	0.95 U	
Heptachlor epoxide	UG/KG	5 U	5 U	5 U	0.95 U	1 U	0.975 U	0.95 U	0.95 U	
Methoxychlor	UG/KG	50 U	50 U	50 U	9.5 U	10 U	9.75 U	9.5 U	9.5 U	
Toxaphene	UG/KG	100 U	95 U	97.5 U	9.5 U	100 U	97.5 U	95 U	95 U	
Aroclor-1016	UG/KG	20.5 U	19.5 U	20 U	18.5 U	19 U	18.75 U	18.5 U	19 U	
Aroclor-1221	UG/KG	20.5 U	19.5 U	20 U	18.5 U	19 U	18.75 U	18.5 U	19 U	
Aroclor-1232	UG/KG	20.5 U	19.5 U	20 U	18.5 U	19 U	18.75 U	18.5 U	19 U	
Aroclor-1242	UG/KG	20.5 U	19.5 U	20 U	18.5 U	19 U	18.75 U	18.5 U	19 U	

Table A-1B
SEAD-59 Soil Sample-Duplicate Merged Results
SEAD-59 AND SEAD-71 PHASE II RI REPORT
Seneca Army Depot Activity

	Facility	SEAD-59	SEAD-59	SEAD-59	SEAD-59	SEAD-59	SEAD-59	SEAD-59	SEAD-59	SEAD-59
	Location ID	FD-59-CL-05	CL-59-01-WS1	FD-59-CL-05/CL-59-01-WS1	FD-59-CL-06	CL-59-01-F10	FD-59-CL-06/CL-59-01-F10	FD-59-CL-3	CL-59-01-WW4	FD-59-CL-3/CL-59-01-WW4
	Maxtrix	SOIL	SOIL	SOIL	SOIL	SOIL	SOIL	SOIL	SOIL	SOIL
	Sample ID	FD-59-CL-05	CL-59-01-WS1	FD-59-CL-05/CL-59-01-WS1	FD-59-CL-06	CL-59-01-F10	FD-59-CL-06/CL-59-01-F10	FD-59-CL-3	CL-59-01-WW4	FD-59-CL-3/CL-59-01-WW4
	Sample Date	5/6/2004	5/6/2004	5/6/2004	5/6/2004	5/6/2004	5/6/2004	5/6/2004	5/6/2004	5/6/2004
	QC Code	SA	DU	SA/DU	SA	DU	SA/DU	SA	DU	SA/DU
	Study ID	ENSR IRM	ENSR IRM	ENSR IRM	ENSR IRM	ENSR IRM	ENSR IRM	ENSR IRM	ENSR IRM	ENSR IRM
Parameter	Units	Value (Q)	Value (Q)	Value (Q)	Value (Q)	Value (Q)	Value (Q)	Value (Q)	Value (Q)	Value (Q)
Aroclor-1248	UG/KG	20.5 U	19.5 U	20 U	18.5 U	19 U	18.75 U	18.5 U	19 U	18.75 U
Aroclor-1254	UG/KG	20.5 U	19.5 U	20 U	18.5 U	19 U	18.75 U	18.5 U	19 U	18.75 U
Aroclor-1260	UG/KG	20.5 U	19.5 U	20 U	18.5 U	19 U	18.75 U	18.5 U	19 U	18.75 U
Metals and Cyanide										
Aluminum	MG/KG	11000	11400	11200	5850 J	10900 J	8375 J	11200 J	12900 J	12050 J
Antimony	MG/KG	1.8 UJ	1.75 UJ	1.775 UJ	1.3 J	1.8 J	1.55 J	1.2 J	2 J	1.6 J
Arsenic	MG/KG	4.1 J	5.7 J	4.9 J	2.7 J	5.9 J	4.3 J	6.5	6.4	6.45
Barium	MG/KG	109	149	129	50.8 J	80.8 J	65.8 J	118 J	117 J	117.5 J
Beryllium	MG/KG	0.22	0.3	0.26	0.3	0.53	0.415	0.58	0.69	0.635
Cadmium	MG/KG	0.15 U	0.145 U	0.1475 U	0.38 J	0.68 J	0.53 J	0.26 J	0.38	0.32 J
Calcium	MG/KG	9650 J	2920 J	6285 J	76500 J	7520 J	42010 J	3320	29800	16560
Chromium	MG/KG	16.4	18.8	17.6	9.1 J	17.8 J	13.45 J	17.4 J	18 J	17.7 J
Cobalt	MG/KG	9.1	13.6	11.35	5.5 J	10.7 J	8.1 J	9.3	7.7	8.5
Copper	MG/KG	19.2	16	17.6	16	20.8	18.4	21.3 J	31.3 J	26.3 J
Cyanide	MG/KG									
Iron	MG/KG	20900 J	25600 J	23250 J	13800	22500	18150	24000 J	20900 J	22450 J
Lead	MG/KG	16.7	12.9	14.8	6.7 J	12.3 J	9.5 J	12.6 J	50.9 J	31.75 J
Magnesium	MG/KG	4000	3890	3945	15500 J	7060 J	11280 J	4050 J	7080 J	5565 J
Manganese	MG/KG	479 J	844 J	661.5 J	282 J	738 J	510 J	453 J	360 J	406.5 J
Mercury	MG/KG	0.03 J	0.04	0.035 J	0.02 J	0.03 J	0.025 J	0.04 J	0.24 J	0.14 J
Nickel	MG/KG	24.6	29.7	27.15	16.4 J	32.5 J	24.45 J	25.1 J	24.3 J	24.7 J
Potassium	MG/KG	1130	1050	1090	908	1180	1044	988	1280	1134
Selenium	MG/KG	0.3 U	0.29 U	0.295 U	0.21 U	0.46 J	0.335 J	0.2 U	0.21 U	0.205 U
Silver	MG/KG	0.3 U	0.29 U	0.295 U	0.055 U	0.64	0.3475 J	1.5	1.2	1.35
Sodium	MG/KG	323 J	34.7 J	178.85 J	161	216	188.5	50.2	73.6	61.9
Thallium	MG/KG	0.3 U	0.86 J	0.58 J	0.105 U	0.115 U	0.11	0.1 U	0.105 U	0.1025 U
Vanadium	MG/KG	20.7	21.7	21.2	9.8 J	18.2 J	14 J	21.2 J	21.3 J	21.25 J
Zinc	MG/KG	90.9 J	70.4 J	80.65 J	33.9 J	77.6 J	55.75 J	71.9 J	84.5 J	78.2 J

Notes

- 1) Sample/Duplicate pairs were manually averaged, Averging Procedure below
- A - Non-Detects were half detection limit, R were ignored
- B - SA/DU chem values were then averaged
- C - SA/DU Qualifiers were selected to represent the discreet sample.
- D - SA/DU sample ID were combined and are marked with "SA/DU"

Table A-1B
SEAD-59 Soil Sample-Duplicate Merged Results
SEAD-59 AND SEAD-71 PHASE II RI REPORT
Seneca Army Depot Activity

Parameter	Facility	SEAD-59	SEAD-59	SEAD-59	SEAD-59	SEAD-59	SEAD-59	SEAD-59	SEAD-59	SEAD-59
	Location ID	FD-59-CL-7	CL-59-01-F23	FD-59-CL-7/CL-59-01-F23	FD-59-W5-6	WS-59-01-012-1	FD-59-W5-6/WS-59-01-012-1	FD-59-WS-01	WS-59-03-001-3	FD-59-WS-01/WS-59-03-001-3
	Matrix	SOIL	SOIL	SOIL	SOIL	SOIL	SOIL	SOIL	SOIL	SOIL
	Sample ID	FD-59-CL-7	CL-59-01-F23	FD-59-CL-7/CL-59-01-F23	FD-59-W5-6	WS-59-01-012-1	FD-59-W5-6/WS-59-01-012-1	FD-59-WS-01	WS-59-03-001-3	FD-59-WS-01/WS-59-03-001-3
	Sample Date	5/6/2004	5/6/2004	5/6/2004	5/6/2004	5/6/2004	5/6/2004	5/6/2004	5/6/2004	5/6/2004
	QC Code	SA	DU	SA/DU	SA	DU	SA/DU	SA	SA	SA/DU
	Study ID	ENSR IRM	ENSR IRM	ENSR IRM	ENSR IRM	ENSR IRM	ENSR IRM	ENSR IRM	ENSR IRM	ENSR IRM
	Units	Value (Q)	Value (Q)	Value (Q)	Value (Q)	Value (Q)	Value (Q)	Value (Q)	Value (Q)	Value (Q)
Volatile Organic Compounds										
1,1,1-Trichloroethane	UG/KG	3 U	2.5 U	2.75 U	3 U	3 U	3 U	2.85 U	2.9 U	2.875 U
1,1,2,2-Tetrachloroethane	UG/KG	3 U	2.5 U	2.75 U	3 U	3 U	3 U	2.85 U	2.9 U	2.875 U
1,1,2-Trichloro-1,2,2-Trifluoroethane	UG/KG	3 U	2.5 U	2.75 U	3 U	3 U	3 U	2.85 U	2.9 U	2.875 U
1,1,2-Trichloroethane	UG/KG	3 U	2.5 U	2.75 U	3 U	3 U	3 U			
1,1-Dichloroethane	UG/KG	3 U	2.5 U	2.75 U	3 U	3 U	3 U	2.85 U	2.9 U	2.875 U
1,1-Dichloroethene	UG/KG	3 U	2.5 U	2.75 U	3 U	3 U	3 U	2.85 U	2.9 U	2.875 U
1,2,3-Trichloropropane	UG/KG							2.85 U	2.9 U	2.875 U
1,2,4-Trichlorobenzene	UG/KG	3 U	2.5 U	2.75 U	3 U	3 U	3 U	2.85 U	2.9 U	2.875 U
1,2-Dibromo-3-chloropropane	UG/KG	3 U	2.5 U	2.75 U	3 U	3 U	3 U			
1,2-Dibromoethane	UG/KG	3 U	2.5 U	2.75 U	3 U	3 U	3 U			
1,2-Dichlorobenzene	UG/KG	3 U	2.5 U	2.75 U	3 U	3 U	3 U	2.85 U	2.9 U	2.875 U
1,2-Dichloroethane	UG/KG	3 U	2.5 U	2.75 U	3 U	3 U	3 U	2.85 U	2.9 U	2.875 U
1,2-Dichloroethene (total)	UG/KG									
1,2-Dichloropropane	UG/KG	3 U	2.5 U	2.75 U	3 U	3 U	3 U			
1,3-Dichlorobenzene	UG/KG	3 U	2.5 U	2.75 U	3 U	3 U	3 U	2.85 U	2.9 U	2.875 U
1,3-Dichloropropane	UG/KG									
1,4-Dichlorobenzene	UG/KG	3 U	2.5 U	2.75 U	3 U	3 U	3 U	2.85 U	2.9 U	2.875 U
Acetone	UG/KG	84 NJ	38 NJ	61 NJ	45 NJ	44 NJ	44.5 NJ	11.5 U	11.5 U	11.5 U
Benzene	UG/KG	3 U	2.5 U	2.75 U	3 U	3 U	3 U	2.85 U	2.9 U	2.875 U
Bromodichloromethane	UG/KG	3 U	2.5 U	2.75 U	3 U	3 U	3 U			
Bromoform	UG/KG	3 U	2.5 U	2.75 U	3 U	3 U	3 U			
Carbon disulfide	UG/KG	3 U	2.5 U	2.75 U	3 U	3 U	3 U	2.85 U	2.9 U	2.875 U
Carbon tetrachloride	UG/KG	3 U	2.5 U	2.75 U	3 U	3 U	3 U	2.85 U	2.9 U	2.875 U
Chlorobenzene	UG/KG	3 U	2.5 U	2.75 U	3 U	3 U	3 U	2.85 U	2.9 U	2.875 U
Chlorodibromomethane	UG/KG	3 U	2.5 U	2.75 U	3 U	3 U	3 U	2.85 U	2.9 U	2.875 U
Chloroethane	UG/KG	3 U	2.5 U	2.75 U	3 U	3 U	3 U	5.5 U	6 U	5.75 U
Chloroform	UG/KG	3 U	2.5 U	2.75 U	3 U	3 U	3 U	2.85 U	2.9 U	2.875 U
Cis-1,2-Dichloroethene	UG/KG	3 U	2.5 U	2.75 U	3 U	3 U	3 U			
Cis-1,3-Dichloropropene	UG/KG	3 U	2.5 U	2.75 U	3 U	3 U	3 U			
Cyclohexane	UG/KG	3 U	2.5 U	2.75 U	3 U	3 U	3 U			
Dichlorodifluoromethane	UG/KG	3 U	2.5 U	2.75 U	3 U	3 U	3 U			
Ethyl benzene	UG/KG	3 U	2.5 U	2.75 U	3 U	3 U	3 U	3.4 J	2.9 U	3.15 J
Isopropylbenzene	UG/KG	3 U	2.5 U	2.75 U	3 U	3 U	3 U			
Meta/Para Xylene	UG/KG							13 J	2.9 UJ	7.95 J
Methyl Acetate	UG/KG	3 U	2.5 U	2.75 U	3 U	3 U	3 U			
Methyl Tertbutyl Ether	UG/KG	3 UJ	2.5 UJ	2.75 UJ	3 U	3 U	3 U			
Methyl bromide	UG/KG	3 UJ	2.5 UJ	2.75 UJ	3 U	3 U	3 U			
Methyl butyl ketone	UG/KG	3 UJ	2.5 UJ	2.75 UJ	3 U	3 U	3 U			
Methyl chloride	UG/KG	3 U	2.5 U	2.75 U	3 U	3 U	3 U			
Methyl cyclohexane	UG/KG	3 U	2.5 U	2.75 U	3 U	3 U	3 U			
Methyl ethyl ketone	UG/KG	14 J	6 J	10 J	4 J	5 J	4.5 J	5.5 U	6 U	5.75 U
Methyl isobutyl ketone	UG/KG	3 UJ	2.5 UJ	2.75 UJ	3 U	3 U	3 U	5.5 U	6 U	5.75 U
Methylene chloride	UG/KG	3 UJ	2.5 UJ	2.75 UJ	3 U	3 U	3 U	1.5 J	1.5 J	1.5 J
Ortho Xylene	UG/KG							4.3 J	2.9 U	3.6 J
Styrene	UG/KG	3 U	2.5 U	2.75 U	3 U	3 U	3 U			
Tetrachloroethene	UG/KG	3 U	2.5 U	2.75 U	3 U	3 U	3 U	2.85 U	2.9 U	2.875 U
Toluene	UG/KG	3 U	2.5 U	2.75 U	3 U	3 U	3 U	5.6 J	2.9 U	4.25 J
Total BTEX	MG/KG									
Total Xylenes	UG/KG	3 U	2.5 U	2.75 U	3 U	3 U	3 U			
Trans-1,2-Dichloroethene	UG/KG	3 U	2.5 U	2.75 U	3 U	3 U	3 U	2.85 U	2.9 U	2.875 U
Trans-1,3-Dichloropropene	UG/KG	3 U	2.5 U	2.75 U	3 U	3 U	3 U			

Table A-1B
SEAD-59 Soil Sample-Duplicate Merged Results
SEAD-59 AND SEAD-71 PHASE II RI REPORT
Seneca Army Depot Activity

Parameter	Units	SEAD-59	SEAD-59	SEAD-59	SEAD-59	SEAD-59	SEAD-59	SEAD-59	SEAD-59	SEAD-59	SEAD-59
		Value (Q)	Value (Q)	Value (Q)	Value (Q)	Value (Q)	Value (Q)	Value (Q)	Value (Q)	Value (Q)	Value (Q)
Trichloroethene	UG/KG	3 U	2.5 U	2.75 U	3 U	3 U	3 U	3 U	2.85 U	2.9 U	2.875 U
Trichlorofluoromethane	UG/KG	3 U	2.5 U	2.75 U	3 U	3 U	3 U	3 U			
Vinyl chloride	UG/KG	3 U	2.5 U	2.75 U	3 U	3 U	3 U	3 U	5.5 U	6 U	5.75 U
Semivolatile Organic Compounds											
1,1'-Biphenyl	UG/KG	195 U	190 U	192.5 U	79 J	215 U		147 J			
1,2,4-Trichlorobenzene	UG/KG										
1,2-Dichlorobenzene	UG/KG										
1,3-Dichlorobenzene	UG/KG										
1,4-Dichlorobenzene	UG/KG										
2,2'-oxybis(1-Chloropropane)	UG/KG	195 U	190 U	192.5 U	185 U	215 U		200 U			
2,4,5-Trichlorophenol	UG/KG	485 U	475 U	480 U	460 U	550 U		505 U	190 U	190 U	190 U
2,4,6-Trichlorophenol	UG/KG	195 U	190 U	192.5 U	185 U	215 U		200 U	190 U	190 U	190 U
2,4-Dichlorophenol	UG/KG	195 U	190 U	192.5 U	185 U	215 U		200 U	190 U	190 U	190 U
2,4-Dimethylphenol	UG/KG	195 U	190 U	192.5 U	185 U	215 U		200 U			
2,4-Dinitrophenol	UG/KG	485 U	475 U	480 U	460 UJ	550 U		505 UJ	950 U	1000 U	975 U
2,4-Dinitrotoluene	UG/KG	195 U	190 U	192.5 U	185 U	215 U		200 U	190 U	190 U	190 U
2,6-Dinitrotoluene	UG/KG	195 U	190 U	192.5 U	185 U	215 U		200 U	190 U	190 U	190 U
2-Chloronaphthalene	UG/KG	195 U	190 U	192.5 U	185 U	215 U		200 U			
2-Chlorophenol	UG/KG	195 U	190 U	192.5 U	185 U	215 U		200 U	190 U	190 U	190 U
2-Methylnaphthalene	UG/KG	195 U	190 U	192.5 U	410	95 J		252.5 J	190 U	190 U	190 U
2-Methylphenol	UG/KG	195 U	190 U	192.5 U	185 U	215 U		200 U	190 U	190 U	190 U
2-Nitroaniline	UG/KG	485 U	475 U	480 U	460 U	550 U		505 U	950 U	1000 U	975 U
2-Nitrophenol	UG/KG	195 U	190 U	192.5 U	185 U	215 U		200 U	190 U	190 U	190 U
3,3'-Dichlorobenzidine	UG/KG	195 U	190 U	192.5 U	185 UJ	215 U		200 UJ	190 U	190 U	190 U
3-Nitroaniline	UG/KG	485 U	475 U	480 U	460 U	550 U		505 U	950 U	1000 U	975 U
4,6-Dinitro-2-methylphenol	UG/KG	485 U	475 U	480 U	460 U	550 U		505 U			
4-Bromophenyl phenyl ether	UG/KG	195 U	190 U	192.5 U	185 U	215 U		200 U			
4-Chloro-3-methylphenol	UG/KG	195 U	190 U	192.5 U	185 U	215 U		200 U	190 U	190 U	190 U
4-Chloroaniline	UG/KG	195 U	190 U	192.5 U	185 UJ	215 U		200 UJ	190 U	190 U	190 U
4-Chlorophenyl phenyl ether	UG/KG	195 U	190 U	192.5 U	185 U	215 U		200 U			
4-Methylphenol	UG/KG	195 U	190 U	192.5 U	185 U	215 U		200 U	190 U	190 U	190 U
4-Nitroaniline	UG/KG	485 U	475 U	480 U	460 U	550 U		505 U			
4-Nitrophenol	UG/KG	485 U	475 U	480 U	460 U	550 U		505 U	950 U	1000 U	975 U
Acenaphthene	UG/KG	195 U	190 U	192.5 U	730	160 J		445 J	190 U	190 U	190 U
Acenaphthylene	UG/KG	195 U	190 U	192.5 U	1000	360 J		680 J	190 U	190 U	190 U
Acetophenone	UG/KG	195 U	190 U	192.5 U	185 U	215 U		200 U			
Aniline	UG/KG								190 U	190 U	190 U
Anthracene	UG/KG	195 U	190 U	192.5 U	2500 J	660 J		1580 J	190 U	190 U	190 U
Atrazine	UG/KG	195 U	190 U	192.5 U	185 U	215 U		200 U			
Benzaldehyde	UG/KG	195 U	190 U	192.5 U	185 U	215 U		200 U			
Benzo(a)anthracene	UG/KG	195 U	190 U	192.5 U	7900 NJ	1800 NJ		4850 NJ	76 J	59 J	67.5 J
Benzo(a)pyrene	UG/KG	195 U	190 U	192.5 U	8400 J	2100 J		5250 J	82 J	61 J	71.5 J
Benzo(b)fluoranthene	UG/KG	195 U	190 U	192.5 U	8600 J	2300 J		5450 J	72 J	61 J	66.5 J
Benzo(ghi)perylene	UG/KG	195 U	190 U	192.5 U	2300 J	1100 J		1700 J	49 J	190 U	119.5 J
Benzo(k)fluoranthene	UG/KG	195 U	190 U	192.5 U	5300 J	980 J		3140 J	70 J	50 J	60 J
Benzoic Acid	UG/KG								950 U	1000 U	975 U
Bis(2-Chloroethoxy)methane	UG/KG	195 U	190 U	192.5 U	185 U	215 U		200 U			
Bis(2-Chloroethyl)ether	UG/KG	195 U	190 U	192.5 U	185 U	215 U		200 U			
Bis(2-Chloroisopropyl)ether	UG/KG										
Bis(2-Ethylhexyl)phthalate	UG/KG	195 U	190 U	192.5 U	150 NJ	215 U		182.5 NJ	190 U	190 U	190 U
Butylbenzylphthalate	UG/KG	195 U	190 U	192.5 U	185 UJ	215 U		200 UJ	190 U	190 U	190 U
Caprolactam	UG/KG	195 U	190 U	192.5 U	185 U	215 U		200 U			

Table A-1B
SEAD-59 Soil Sample-Duplicate Merged Results
SEAD-59 AND SEAD-71 PHASE II RI REPORT
Seneca Army Depot Activity

Parameter	Units	SEAD-59	SEAD-59	SEAD-59	SEAD-59	SEAD-59	SEAD-59	SEAD-59	SEAD-59	SEAD-59
		Value (Q)	Value (Q)	Value (Q)	Value (Q)	Value (Q)	Value (Q)	Value (Q)	Value (Q)	Value (Q)
Carbazole	UG/KG	195 U	190 U	192.5 U	380	110 J	245 J			
Chrysene	UG/KG	195 U	190 U	192.5 U	7700 J	1800 J	4750 J	90 J	69 J	79.5 J
Di-n-butylphthalate	UG/KG	195 U	190 U	192.5 U	185 U	215 U	200 U	190 U	190 U	190 U
Di-n-octylphthalate	UG/KG	195 U	190 U	192.5 U	185 UJ	215 U	200 UJ	190 U	190 U	190 U
Dibenz(a,h)anthracene	UG/KG	195 U	190 U	192.5 U	1100 J	320 J	710 J	190 U	190 U	190 U
Dibenzofuran	UG/KG	195 U	190 U	192.5 U	430	86 J	258 J	190 U	190 U	190 U
Diethyl phthalate	UG/KG	195 U	190 U	192.5 U	185 U	215 U	200 U	190 U	190 U	190 U
Dimethylphthalate	UG/KG	195 U	190 U	192.5 U	185 U	215 U	200 U	190 U	190 U	190 U
Fluoranthene	UG/KG	195 U	190 U	192.5 U	13000 J	3300 J	8150 J	170 J	110 J	140 J
Fluorene	UG/KG	195 U	190 U	192.5 U	1200 J	240 J	720 J	190 U	190 U	190 U
Hexachlorobenzene	UG/KG	195 U	190 U	192.5 U	185 U	215 U	200 U	190 U	190 U	190 U
Hexachlorobutadiene	UG/KG	195 U	190 U	192.5 U	185 U	215 U	200 U	190 U	190 U	190 U
Hexachlorocyclopentadiene	UG/KG	195 U	190 U	192.5 U	185 U	215 U	200 U			
Hexachloroethane	UG/KG	195 U	190 U	192.5 U	185 U	215 U	200 U	190 U	190 U	190 U
Indeno(1,2,3-cd)pyrene	UG/KG	195 U	190 U	192.5 U	2500 J	1200 J	1850 J	45 J	190 U	117.5 J
Isophorone	UG/KG	195 U	190 U	192.5 U	185 U	215 U	200 U	190 U	190 U	190 U
N-Nitrosodiphenylamine	UG/KG	195 U	190 U	192.5 U	185 U	215 U	200 U			
N-Nitrosodipropylamine	UG/KG	195 U	190 U	192.5 U	185 U	215 U	200 U			
Naphthalene	UG/KG	195 U	190 U	192.5 U	390	110 J	250 J	190 U	190 U	190 U
Nitrobenzene	UG/KG	195 U	190 U	192.5 U	185 U	215 U	200 U	190 U	190 U	190 U
Pentachlorophenol	UG/KG	485 U	475 U	480 U	460 U	550 U	505 U	950 U	1000 U	975 U
Phenanthrene	UG/KG	195 U	190 U	192.5 U	6900 J	1500 J	4200 J	98 J	73 J	85.5 J
Phenol	UG/KG	195 U	190 U	192.5 U	185 U	215 U	200 U	190 U	190 U	190 U
Pyrene	UG/KG	195 U	190 U	192.5 U	13000 J	3400 J	8200 J	140 J	100 J	120 J
Pyridine	UG/KG	195 U	190 U	192.5 U				950 U	1000 U	975 U
Total Unknown PAHs as SV	MG/KG									
Pesticides/PCBs										
4,4'-DDD	UG/KG	1.9 U	1.9 U	1.9 U	8.3 J	10 NJ	9.15 NJ	9.5 U	9.5 U	9.5 U
4,4'-DDE	UG/KG	1.9 U	1.9 U	1.9 U	43 J	11 NJ	27 NJ	9.5 U	9.5 U	9.5 U
4,4'-DDT	UG/KG	1.9 U	1.9 U	1.9 U	14 J	4.9 J	9.45 J	9.5 U	9.5 U	9.5 U
Aldrin	UG/KG	1 U	1 U	1 U	0.95 U	1.1 U	1.025 U	4.85 U	4.95 U	4.9 U
Alpha-BHC	UG/KG	1 U	1 U	1 U	0.95 U	1.1 U	1.025 U	4.85 U	4.95 U	4.9 U
Alpha-Chlordane	UG/KG	1 U	1 UJ	1 UJ	0.95 U	1.1 U	1.025 U	4.85 U	4.95 U	4.9 U
Beta-BHC	UG/KG	1 U	1 U	1 U	0.95 U	1.1 U	1.025 U	4.85 U	4.95 U	4.9 U
Delta-BHC	UG/KG	1 U	1 UJ	1 UJ	0.95 U	1.1 U	1.025 U	4.85 U	4.95 U	4.9 U
Dieldrin	UG/KG	1.9 U	1.9 U	1.9 U	1.85 U	2.15 U	2 U	9.5 U	9.5 U	9.5 U
Endosulfan I	UG/KG	1 U	1 U	1 U	0.95 U	1.1 U	1.025 U	4.85 U	4.95 U	4.9 U
Endosulfan II	UG/KG	1.9 U	1.9 U	1.9 U	1.85 U	2.15 U	2 U	9.5 U	9.5 U	9.5 U
Endosulfan sulfate	UG/KG	1.9 U	1.9 U	1.9 U	1.85 U	2.15 U	2 U	9.5 U	9.5 U	9.5 U
Endrin	UG/KG	1.9 U	1.9 U	1.9 U	1.85 U	2.15 U	2 U	9.5 U	9.5 U	9.5 U
Endrin aldehyde	UG/KG	1.9 U	1.9 U	1.9 U	5.5 NJ	2.15 U	3.825 NJ	9.5 U	9.5 U	9.5 U
Endrin ketone	UG/KG	1.9 U	1.9 U	1.9 U	12 J	2.15 U	7.075 J	9.5 U	9.5 U	9.5 U
Gamma-BHC/Lindane	UG/KG	1 U	1 U	1 U	0.95 U	1.1 U	1.025 U	4.85 U	4.95 U	4.9 U
Gamma-Chlordane	UG/KG	1 U	1 UJ	1 UJ	0.95 U	1.1 U	1.025 U	4.85 U	4.95 U	4.9 U
Heptachlor	UG/KG	1 U	1 U	1 U	0.95 U	1.1 U	1.025 U	4.85 U	4.95 U	4.9 U
Heptachlor epoxide	UG/KG	1 U	1 U	1 U	0.95 U	1.1 U	1.025 U	4.85 U	4.95 U	4.9 U
Methoxychlor	UG/KG	10 U	10 U	10 U	9.5 U	11 U	10.25 U	48.5 U	49.5 U	49 U
Toxaphene	UG/KG	100 U	100 U	100 U	95 U	110 U	102.5 U	95 U	95 U	95 U
Aroclor-1016	UG/KG	19.5 U	19 U	19.25 U	18.5 U	22 U	20.25 U	19 U	19 U	19 U
Aroclor-1221	UG/KG	19.5 U	19 U	19.25 U	18.5 U	22 U	20.25 U	19 U	19 U	19 U
Aroclor-1232	UG/KG	19.5 U	19 U	19.25 U	18.5 U	22 U	20.25 U	19 U	19 U	19 U
Aroclor-1242	UG/KG	19.5 U	19 U	19.25 U	18.5 U	22 U	20.25 U	19 U	19 U	19 U

Table A-1B
SEAD-59 Soil Sample-Duplicate Merged Results
SEAD-59 AND SEAD-71 PHASE II RI REPORT
Seneca Army Depot Activity

Parameter	Units	SEAD-59	SEAD-59	SEAD-59	SEAD-59	SEAD-59	SEAD-59	SEAD-59	SEAD-59	SEAD-59
		Value (Q)	Value (Q)	Value (Q)	Value (Q)	Value (Q)	Value (Q)	Value (Q)	Value (Q)	Value (Q)
Aroclor-1248	UG/KG	19.5 U	19 U	19.25 U	18.5 U	22 U	20.25 U	19 U	19 U	19 U
Aroclor-1254	UG/KG	19.5 U	19 U	19.25 U	18.5 U	22 U	20.25 U	19 U	19 U	19 U
Aroclor-1260	UG/KG	19.5 U	19 U	19.25 U	18.5 U	22 U	20.25 U	19 U	19 U	19 U
Metals and Cyanide										
Aluminum	MG/KG	11800 J	15600 J	13700 J	10700 J	12600 J	11650 J	10500	11000	10750
Antimony	MG/KG	2 J	2.2 J	2.1 J	1.7 J	1.8 J	1.75 J	1.7 UJ	1.7 UJ	1.7 UJ
Arsenic	MG/KG	3.9 J	7.3 J	5.6 J	5.8 J	6.5 J	6.15 J	4.5	4.9	4.7
Barium	MG/KG	71.2 J	84.8 J	78 J	84 J	112 J	98 J	94	94.7	94.35
Beryllium	MG/KG	0.56	0.88	0.72	0.55	0.67	0.61	0.22	0.29	0.255
Cadmium	MG/KG	0.34 J	0.64 J	0.49 J	0.49	0.53	0.51	0.14 U	0.14 U	0.14 U
Calcium	MG/KG	1370 J	4890 J	3130 J	66900 J	19900 J	43400 J	67600	50900	59250
Chromium	MG/KG	15.7 J	23.7 J	19.7 J	19 J	18.7 J	18.85 J	16.3	17.6	16.95
Cobalt	MG/KG	8 J	12.7 J	10.35 J	9.7 J	10.7 J	10.2 J	7.9	7.9	7.9
Copper	MG/KG	6.5 J	36.3 J	21.4 J	27 J	23.5 J	25.25 J	20.3	21.7	21
Cyanide	MG/KG									
Iron	MG/KG	19000 J	29000 J	24000 J	22000 J	22600 J	22300 J	19600	21800	20700
Lead	MG/KG	13.2 J	15.9 J	14.55 J	28.7 J	27.9 J	28.3 J	15.9 J	19.5 J	17.7 J
Magnesium	MG/KG	2750 J	6480 J	4615 J	6880 J	6490 J	6685 J	8290	9690	8990
Manganese	MG/KG	225 J	341 J	283 J	443 J	708 J	575.5 J	445	361	403
Mercury	MG/KG	0.04	0.05	0.045	0.06	0.07	0.065	0.06	0.05	0.055
Nickel	MG/KG	14.1 J	40.5 J	27.3 J	31.9 J	29.2 J	30.55 J	24.1	25.9	25
Potassium	MG/KG	608 J	959 J	783.5 J	1230 J	1340 J	1285 J	1030	1100	1065
Selenium	MG/KG	0.77 J	0.22 U	0.495 J	0.19 U	0.245 U	0.2175 U	0.28 U	0.285 U	0.2825 U
Silver	MG/KG	0.67	0.61	0.64	0.24 J	1.1	0.67 J	0.28 U	0.285 U	0.2825 U
Sodium	MG/KG	412 J	365 J	388.5 J	153 J	188 J	170.5 J	101	113	107
Thallium	MG/KG	0.11 U	0.11 U	0.11 U	0.095 U	0.125 U	0.11 U	0.28 U	0.6 J	0.44 J
Vanadium	MG/KG	21 J	23.2 J	22.1 J	18.8 J	21.9 J	20.35 J	17.3	18.8	18.05
Zinc	MG/KG	40.5 J	78.8 J	59.65 J	67.2 J	82 J	74.6 J	74.6 J	79.1 J	76.85 J

Notes
1) Sample/Duplicate pairs were manually averaged,
Averging Procedure below
A - Non-Detects were half detection
limit, R were ignored
B - SA/DU chem values were then averaged
C - SA/DU Qualifiers were selected to
represent the discreet sample.
D - SA/DU sample ID were combined and are
marked with "SA/DU"

Table A-1B
SEAD-59 Soil Sample-Duplicate Merged Results
SEAD-59 AND SEAD-71 PHASE II RI REPORT
Seneca Army Depot Activity

Parameter	Facility	SEAD-59	SEAD-59	SEAD-59	SEAD-59	SEAD-59	SEAD-59	SEAD-59	SEAD-59	SEAD-59	SEAD-59
	Location ID	FD-59-WS-05	WS-59-04-010-4	FD-59-WS-05/WS-59-04-010-4	FD-59-WS-07	WS-59-01-015-13	FD-59-WS-07/WS-59-01-015-13	FD-59-WS-8	WS-59-01-016-15	FD-59-WS-8/WS-59-01-016-15	
	Maxtrix	SOIL	SOIL	SOIL	SOIL	SOIL	SOIL	SOIL	SOIL	SOIL	
	Sample ID	FD-59-WS-05	WS-59-04-010-4	FD-59-WS-05/WS-59-04-010-4	FD-59-WS-07	WS-59-01-015-13	FD-59-WS-07/WS-59-01-015-13	FD-59-WS-8	WS-59-01-016-15	FD-59-WS-8/WS-59-01-016-15	
	Sample Date	5/6/2004	5/6/2004	5/6/2004	5/6/2004	5/6/2004	5/6/2004	5/6/2004	5/6/2004	5/6/2004	
	QC Code	SA	DU	SA/DU	SA	DU	SA/DU	SA	DU	SA/DU	
	Study ID	ENSR IRM	ENSR IRM	ENSR IRM	ENSR IRM	ENSR IRM	ENSR IRM	ENSR IRM	ENSR IRM	ENSR IRM	
	Units	Value (Q)	Value (Q)	Value (Q)	Value (Q)	Value (Q)	Value (Q)	Value (Q)	Value (Q)	Value (Q)	
Volatile Organic Compounds											
1,1,1-Trichloroethane	UG/KG	2.5 U	3 U	2.75 U	2.9 U	2.95 U	2.925 U	2.85 U	2.9 U	2.875 U	
1,1,2,2-Tetrachloroethane	UG/KG	2.5 U	3 UJ	2.75 UJ	2.9 U	2.95 U	2.925 U	2.85 U	2.9 UJ	2.875 UJ	
1,1,2-Trichloro-1,2,2-Trifluoroethane	UG/KG	2.5 UJ	3 UJ	2.75 UJ	2.9 U	2.95 U	2.925 U	2.85 U	2.9 UJ	2.875 UJ	
1,1,2-Trichloroethane	UG/KG	2.5 U	3 U	2.75 U							
1,1-Dichloroethane	UG/KG	2.5 U	3 U	2.75 U	2.9 U	2.95 U	2.925 U	2.85 U	2.9 U	2.875 U	
1,1-Dichloroethene	UG/KG	2.5 U	3 U	2.75 U	2.9 U	2.95 U	2.925 U	2.85 U	2.9 U	2.875 U	
1,2,3-Trichloropropane	UG/KG				2.9 U	2.95 U	2.925 U	2.85 U	2.9 U	2.875 U	
1,2,4-Trichlorobenzene	UG/KG	2.5 U	3 UJ	2.75 UJ	2.9 U	2.95 U	2.925 U	2.85 U	2.9 U	2.875 U	
1,2-Dibromo-3-chloropropane	UG/KG	2.5 U	3 UJ	2.75 UJ							
1,2-Dibromoethane	UG/KG	2.5 U	3 U	2.75 U							
1,2-Dichlorobenzene	UG/KG	2.5 U	3 UJ	2.75 UJ	2.9 U	2.95 U	2.925 U	2.85 U	2.9 U	2.875 U	
1,2-Dichloroethane	UG/KG	2.5 U	3 U	2.75 U	2.9 U	2.95 U	2.925 U	2.85 U	2.9 U	2.875 U	
1,2-Dichloroethene (total)	UG/KG										
1,2-Dichloropropane	UG/KG	2.5 U	3 U	2.75 U							
1,3-Dichlorobenzene	UG/KG	2.5 U	3 UJ	2.75 UJ	2.9 U	2.95 U	2.925 U	2.85 U	2.9 U	2.875 U	
1,3-Dichloropropane	UG/KG				2.9 U	2.95 U	2.925 U	2.85 U	2.9 U	2.875 U	
1,4-Dichlorobenzene	UG/KG	2.5 U	3 UJ	2.75 UJ	2.9 U	2.95 U	2.925 U	2.85 U	2.9 U	2.875 U	
Acetone	UG/KG	2.5 U	3 U	2.75 U	11.5 U	12 U	11.75 U	11.5 U	11.5 U	11.5 U	
Benzene	UG/KG	2.5 U	3 U	2.75 U	2.9 U	2.95 U	2.925 U	2.85 U	2.9 U	2.875 U	
Bromodichloromethane	UG/KG	2.5 U	3 U	2.75 U							
Bromoform	UG/KG	2.5 U	3 U	2.75 U							
Carbon disulfide	UG/KG	2.5 U	3 U	2.75 U	2.9 U	2.95 U	2.925 U	2.85 U	2.9 U	2.875 U	
Carbon tetrachloride	UG/KG	2.5 U	3 U	2.75 U	2.9 U	2.95 U	2.925 U	2.85 U	2.9 U	2.875 U	
Chlorobenzene	UG/KG	2.5 U	3 U	2.75 U	2.9 U	2.95 U	2.925 U	2.85 U	2.9 U	2.875 U	
Chlorodibromomethane	UG/KG	2.5 U	3 U	2.75 U	2.9 U	2.95 U	2.925 U	2.85 U	2.9 U	2.875 U	
Chloroethane	UG/KG	2.5 U	3 U	2.75 U	6 U	6 U	6 U	5.5 U	6 U	5.75 U	
Chloroform	UG/KG	2.5 U	3 U	2.75 U	2.9 U	2.95 U	2.925 U	2.85 U	2.9 U	2.875 U	
Cis-1,2-Dichloroethene	UG/KG	2.5 U	3 U	2.75 U							
Cis-1,3-Dichloropropene	UG/KG	2.5 U	3 U	2.75 U							
Cyclohexane	UG/KG	2.5 U	3 U	2.75 U							
Dichlorodifluoromethane	UG/KG	2.5 U	3 U	2.75 U							
Ethyl benzene	UG/KG	2.5 U	3 U	2.75 U	2.9 U	2.95 U	2.925 U	2.85 U	2.9 U	2.875 U	
Isopropylbenzene	UG/KG	2.5 U	3 U	2.75 U							
Meta/Para Xylene	UG/KG				2.9 U	2.95 U	2.925 U	2.85 U	2.9 U	2.875 U	
Methyl Acetate	UG/KG	2.5 U	3 U	2.75 U							
Methyl Tertbutyl Ether	UG/KG	2.5 U	3 U	2.75 U							
Methyl bromide	UG/KG	2.5 U	3 U	2.75 U							
Methyl butyl ketone	UG/KG	2.5 U	3 U	2.75 U							
Methyl chloride	UG/KG	2.5 U	3 U	2.75 U							
Methyl cyclohexane	UG/KG	2.5 U	3 U	2.75 U							
Methyl ethyl ketone	UG/KG	2.5 U	3 U	2.75 U	6 U	6 U	6 U	5.5 U	6 U	5.75 U	
Methyl isobutyl ketone	UG/KG	2.5 U	3 U	2.75 U	6 U	6 U	6 U	5.5 U	6 U	5.75 U	
Methylene chloride	UG/KG	2.5 U	3 U	2.75 U	2.9 U	2.95 U	2.925 U	2.85 U	2.9 U	2.875 U	
Ortho Xylene	UG/KG				2.9 U	2.95 U	2.925 U	2.85 U	2.9 U	2.875 U	
Styrene	UG/KG	2.5 U	3 U	2.75 U							
Tetrachloroethene	UG/KG	2.5 U	3 U	2.75 U	2.9 U	2.95 U	2.925 U	2.2 J	2.9 U	2.55 J	
Toluene	UG/KG	2.5 U	3 U	2.75 U	2.9 U	2.95 U	2.925 U	2.85 U	2.9 U	2.875 U	
Total BTEX	MG/KG										
Total Xylenes	UG/KG	2.5 U	3 UJ	2.75 UJ							
Trans-1,2-Dichloroethene	UG/KG	2.5 U	3 U	2.75 U	2.9 U	2.95 U	2.925 U	2.85 U	2.9 U	2.875 U	
Trans-1,3-Dichloropropene	UG/KG	2.5 U	3 U	2.75 U							

Table A-1B
SEAD-59 Soil Sample-Duplicate Merged Results
SEAD-59 AND SEAD-71 PHASE II RI REPORT
Seneca Army Depot Activity

Parameter	Facility	SEAD-59	SEAD-59	SEAD-59	SEAD-59	SEAD-59	SEAD-59	SEAD-59	SEAD-59	SEAD-59	SEAD-59
	Location ID	FD-59-WS-05	WS-59-04-010-4	FD-59-WS-05/WS-59-04-010-4	FD-59-WS-07	WS-59-01-015-13	FD-59-WS-07/WS-59-01-015-13	FD-59-WS-8	WS-59-01-016-15	FD-59-WS-8/WS-59-01-016-15	
Units	Maxitrix	SOIL	SOIL	SOIL	SOIL	SOIL	SOIL	SOIL	SOIL	SOIL	
Value (Q)	Sample ID	FD-59-WS-05	WS-59-04-010-4	FD-59-WS-05/WS-59-04-010-4	FD-59-WS-07	WS-59-01-015-13	FD-59-WS-07/WS-59-01-015-13	FD-59-WS-8	WS-59-01-016-15	FD-59-WS-8/WS-59-01-016-15	
Value (Q)	Sample Date	5/6/2004	5/6/2004	5/6/2004	5/6/2004	5/6/2004	5/6/2004	5/6/2004	5/6/2004	5/6/2004	
Value (Q)	QC Code	SA	DU	SA/DU	SA	DU	SA/DU	SA	DU	SA/DU	
Value (Q)	Study ID	ENSR IRM	ENSR IRM	ENSR IRM	ENSR IRM	ENSR IRM	ENSR IRM	ENSR IRM	ENSR IRM	ENSR IRM	
Trichloroethene	UG/KG	2.5 U	3 U	2.75 U	2.9 U	2.95 U	2.925 U	2.85 U	2.9 U	2.875 U	
Trichlorofluoromethane	UG/KG	2.5 U	3 U	2.75 U							
Vinyl chloride	UG/KG	2.5 U	3 U	2.75 U	6 U	6 U	6 U	5.5 U	6 U	5.75 U	
Semivolatile Organic Compounds											
1,1'-Biphenyl	UG/KG	170 U	180 U	175 U							
1,2,4-Trichlorobenzene	UG/KG										
1,2-Dichlorobenzene	UG/KG										
1,3-Dichlorobenzene	UG/KG										
1,4-Dichlorobenzene	UG/KG										
2,2'-oxybis(1-Chloropropane)	UG/KG	170 U	180 U	175 U							
2,4,5-Trichlorophenol	UG/KG	435 U	460 U	447.5 U	1950 U	950 U	1450 U	550 U	600 U	575 U	
2,4,6-Trichlorophenol	UG/KG	170 U	180 U	175 U	1950 U	950 U	1450 U	550 U	600 U	575 U	
2,4-Dichlorophenol	UG/KG	170 U	180 U	175 U	1950 U	950 U	1450 U	550 U	600 U	575 U	
2,4-Dimethylphenol	UG/KG	170 U	180 U	175 U							
2,4-Dinitrophenol	UG/KG	435 U	460 U	447.5 U	10000 U	5000 U	7500 U	2950 U	2950 UJ	2950 UJ	
2,4-Dinitrotoluene	UG/KG	170 U	180 U	175 U	1950 U	950 U	1450 U	550 U	600 U	575 U	
2,6-Dinitrotoluene	UG/KG	170 U	180 U	175 U	1950 U	950 U	1450 U	550 U	600 U	575 U	
2-Chloronaphthalene	UG/KG	170 U	180 U	175 U							
2-Chlorophenol	UG/KG	170 U	180 U	175 U	1950 U	950 U	1450 U	550 U	600 U	575 U	
2-Methylnaphthalene	UG/KG	170 U	110 J	140 J	690 J	950 U	820 J	150 J	600 U	375 J	
2-Methylphenol	UG/KG	170 U	180 U	175 U	1950 U	950 U	1450 U	550 U	600 U	575 U	
2-Nitroaniline	UG/KG	435 U	460 U	447.5 U	10000 U	5000 U	7500 U	2950 U	2950 U	2950 U	
2-Nitrophenol	UG/KG	170 U	180 U	175 U	1950 U	950 U	1450 U	550 U	600 U	575 U	
3,3'-Dichlorobenzidine	UG/KG	170 U	180 U	175 U	1950 U	950 U	1450 U	550 U	600 U	575 U	
3-Nitroaniline	UG/KG	435 U	460 U	447.5 U	10000 U	5000 U	7500 U	2950 U	2950 U	2950 U	
4,6-Dinitro-2-methylphenol	UG/KG	435 U	460 U	447.5 U							
4-Bromophenyl phenyl ether	UG/KG	170 U	180 U	175 U							
4-Chloro-3-methylphenol	UG/KG	170 U	180 U	175 U	1950 U	950 U	1450 U	550 U	600 U	575 U	
4-Chloroaniline	UG/KG	170 U	180 U	175 U	1950 U	950 U	1450 U	550 U	600 U	575 U	
4-Chlorophenyl phenyl ether	UG/KG	170 U	180 U	175 U							
4-Methylphenol	UG/KG	170 U	180 U	175 U	1950 U	950 U	1450 U	550 U	600 U	575 U	
4-Nitroaniline	UG/KG	435 U	460 U	447.5 U							
4-Nitrophenol	UG/KG	435 U	460 U	447.5 U	10000 U	5000 U	7500 U	2950 U	2950 U	2950 U	
Acenaphthene	UG/KG	170 U	310 J	240 J	5100 J	260 J	2680 J	210 J	600 U	405 J	
Acenaphthylene	UG/KG	170 U	91 J	130.5 J	520 J	590 J	555 J	680 J	230 J	455 J	
Acetophenone	UG/KG	170 U	180 U	175 U							
Aniline	UG/KG				1950 U	950 U	1450 U	550 U	600 U	575 U	
Anthracene	UG/KG	30 J	580	305 J	8200 J	590 J	4395 J	810 J	250 J	530 J	
Atrazine	UG/KG	170 U	180 U	175 U							
Benzaldehyde	UG/KG	170 U	180 U	175 U							
Benzo(a)anthracene	UG/KG	71 NJ	1100	585.5 NJ	16000 J	1800 J	8900 J	2500 J	780 J	1640 J	
Benzo(a)pyrene	UG/KG	65 J	990	527.5 J	14000 J	2100 J	8050 J	2600	870 J	1735 J	
Benzo(b)fluoranthene	UG/KG	86 J	1200	643 J	12000 J	1600 J	6800 J	2000	670 J	1335 J	
Benzo(ghi)perylene	UG/KG	34 NJ	480	257 NJ	9000 J	1400 J	5200 J	1800	590 J	1195 J	
Benzo(k)fluoranthene	UG/KG	30 J	470	250 J	13000 J	1700 J	7350 J	2100	720 J	1410 J	
Benzoic Acid	UG/KG				10000 UJ	5000 UJ	7500 UJ	2950 U	2950 U	2950 U	
Bis(2-Chloroethoxy)methane	UG/KG	170 U	180 U	175 U							
Bis(2-Chloroethyl)ether	UG/KG	170 U	180 U	175 U							
Bis(2-Chloroisopropyl)ether	UG/KG										
Bis(2-Ethylhexyl)phthalate	UG/KG	47 J	42 NJ	44.5 NJ	1950 U	950 U	1450 U	550 U	600 U	575 U	
Butylbenzylphthalate	UG/KG	170 U	180 U	175 U	1950 U	950 U	1450 U	550 U	600 U	575 U	
Caprolactam	UG/KG	170 U	180 U	175 U							

Table A-1B
SEAD-59 Soil Sample-Duplicate Merged Results
SEAD-59 AND SEAD-71 PHASE II RI REPORT
Seneca Army Depot Activity

Parameter	Units	SEAD-59	SEAD-59	SEAD-59	SEAD-59	SEAD-59	SEAD-59	SEAD-59	SEAD-59	SEAD-59
		Value (Q)	Value (Q)	Value (Q)	Value (Q)	Value (Q)	Value (Q)	Value (Q)	Value (Q)	Value (Q)
Carbazole	UG/KG	170 U	320 J	245 J						
Chrysene	UG/KG	66 J	990	528 J	16000 J	1800 J	8900 J	2400	860 J	1630 J
Di-n-butylphthalate	UG/KG	170 U	180 U	175 U	1950 U	950 U	1450 U	550 U	600 U	575 U
Di-n-octylphthalate	UG/KG	170 U	180 U	175 U	1950 U	950 U	1450 U	550 U	600 U	575 U
Dibenz(a,h)anthracene	UG/KG	170 U	140 J	155 J	2900 J	430 J	1665 J	570 J	150 NJ	360 NJ
Dibenzofuran	UG/KG	170 U	200 J	185 J	2800 J	950 U	1875 J	160 J	600 U	380 J
Diethyl phthalate	UG/KG	170 U	180 U	175 U	1950 U	950 U	1450 U	550 U	600 U	575 U
Dimethylphthalate	UG/KG	170 U	180 U	175 U	1950 U	950 U	1450 U	550 U	600 U	575 U
Fluoranthene	UG/KG	130 J	2200	1165 J	44000 J	3000 J	23500 J	4700	1600	3150
Fluorene	UG/KG	170 U	300 J	235 J	5000 J	280 J	2640 J	320 J	600 U	460 J
Hexachlorobenzene	UG/KG	170 U	180 U	175 U	1950 U	950 U	1450 U	550 U	600 U	575 U
Hexachlorobutadiene	UG/KG	170 U	180 U	175 U	1950 U	950 U	1450 U	550 U	600 U	575 U
Hexachlorocyclopentadiene	UG/KG	170 U	180 U	175 U						
Hexachloroethane	UG/KG	170 U	180 U	175 U	1950 U	950 U	1450 U	550 U	600 U	575 U
Indeno(1,2,3-cd)pyrene	UG/KG	36 J	530	283 J	8700 J	1200 J	4950 J	1600 J	530 J	1065 J
Isophorone	UG/KG	170 U	180 U	175 U	1950 U	950 U	1450 U	550 U	600 U	575 U
N-Nitrosodiphenylamine	UG/KG	170 U	180 U	175 U						
N-Nitrosodipropylamine	UG/KG	170 U	180 U	175 U						
Naphthalene	UG/KG	170 U	420	295 J	1700 J	950 U	1325 J	210 J	600 U	405 J
Nitrobenzene	UG/KG	170 U	180 U	175 U	1950 U	950 U	1450 U	550 U	600 U	575 U
Pentachlorophenol	UG/KG	435 U	460 U	447.5 U	10000 U	5000 U	7500 U	2950 U	2950 U	2950 U
Phenanthrene	UG/KG	99 J	2100	1099.5 J	41000 J	1600 J	21300 J	2500	640 J	1570 J
Phenol	UG/KG	170 U	180 U	175 U	1950 U	950 U	1450 U	550 U	600 U	575 U
Pyrene	UG/KG	120 J	1900	1010 J	35000 J	3400 J	19200 J	4000 J	1200 J	2600 J
Pyridine	UG/KG				10000 U	5000 U	7500 U	2950 U	2950 U	2950 U
Total Unknown PAHs as SV	MG/KG									
Pesticides/PCBs										
4,4'-DDD	UG/KG	1.7 UJ	1.85 U	1.775 UJ	51 J	9.5 UJ	30.25 J	47.5 U	48 U	47.75 U
4,4'-DDE	UG/KG	1.7 UJ	10 J	5.85 J	29 J	20	24.5 J	47.5 U	48 U	47.75 U
4,4'-DDT	UG/KG	1.7 UJ	19	10.35 J	55 J	20 J	37.5 J	47.5 U	48 U	47.75 U
Aldrin	UG/KG	0.9 U	0.95 U	0.925 U	5 U	5 U	5 U	24.5 U	24.5 U	24.5 U
Alpha-BHC	UG/KG	0.9 U	0.95 U	0.925 U	5 U	5 U	5 U	24.5 U	24.5 U	24.5 U
Alpha-Chlordane	UG/KG	0.9 UJ	0.95 U	0.925 UJ	5 U	5 U	5 U	24.5 U	24.5 U	24.5 U
Beta-BHC	UG/KG	0.9 U	0.95 U	0.925 U	5 U	5 U	5 U	24.5 U	24.5 U	24.5 U
Delta-BHC	UG/KG	0.9 U	0.95 U	0.925 U	5 U	5 U	5 U	24.5 U	24.5 U	24.5 U
Dieldrin	UG/KG	1.7 U	1.85 U	1.775 U	9.5 U	9.5 U	9.5 U	47.5 U	48 U	47.75 U
Endosulfan I	UG/KG	0.9 U	0.95 U	0.925 U	5 U	5 U	5 U	24.5 U	24.5 U	24.5 U
Endosulfan II	UG/KG	1.7 U	1.85 U	1.775 U	9.5 U	9.5 U	9.5 U	47.5 U	48 U	47.75 U
Endosulfan sulfate	UG/KG	1.7 U	1.85 U	1.775 U	9.5 U	9.5 U	9.5 U	47.5 U	48 U	47.75 U
Endrin	UG/KG	1.7 U	1.85 U	1.775 U	9.5 U	9.5 U	9.5 U	47.5 U	48 U	47.75 U
Endrin aldehyde	UG/KG	1.7 U	1.85 U	1.775 U	9.5 U	9.5 U	9.5 U	47.5 U	48 U	47.75 U
Endrin ketone	UG/KG	1.7 U	1.85 U	1.775 U	9.5 U	9.5 U	9.5 U	47.5 U	48 U	47.75 U
Gamma-BHC/Lindane	UG/KG	0.9 U	0.95 U	0.925 U	5 U	5 U	5 U	24.5 U	24.5 U	24.5 U
Gamma-Chlordane	UG/KG	0.9 UJ	0.95 U	0.925 UJ	5 U	5 U	5 U	24.5 U	24.5 U	24.5 U
Heptachlor	UG/KG	0.9 U	0.95 U	0.925 U	5 U	5 U	5 U	24.5 U	24.5 U	24.5 U
Heptachlor epoxide	UG/KG	0.9 U	0.95 U	0.925 U	5 U	5 U	5 U	24.5 U	24.5 U	24.5 U
Methoxychlor	UG/KG	9 UJ	9.5 U	9.25 UJ	49.5 U	50 U	49.75 U	245 U	245 U	245 U
Toxaphene	UG/KG	90 U	95 U	92.5 U	95 U	95 U	95 U	475 U	480 U	477.5 U
Aroclor-1016	UG/KG	17.5 U	18.5 U	18 U	19.5 U	19.5 U	19.5 U	19 U	19 U	19 U
Aroclor-1221	UG/KG	17.5 U	18.5 U	18 U	19.5 U	19.5 U	19.5 U	19 U	19 U	19 U
Aroclor-1232	UG/KG	17.5 U	18.5 U	18 U	19.5 U	19.5 U	19.5 U	19 U	19 U	19 U
Aroclor-1242	UG/KG	17.5 U	18.5 U	18 U	19.5 U	19.5 U	19.5 U	19 U	19 U	19 U

Table A-1B
SEAD-59 Soil Sample-Duplicate Merged Results
SEAD-59 AND SEAD-71 PHASE II RI REPORT
Seneca Army Depot Activity

Parameter	Facility	SEAD-59	SEAD-59	SEAD-59	SEAD-59	SEAD-59	SEAD-59	SEAD-59	SEAD-59	SEAD-59	SEAD-59
	Location ID	FD-59-WS-05	WS-59-04-010-4	FD-59-WS-05/WS-59-04-010-4	FD-59-WS-07	WS-59-01-015-13	FD-59-WS-07/WS-59-01-015-13	FD-59-WS-8	WS-59-01-016-15	FD-59-WS-8/WS-59-01-016-15	FD-59-WS-8/WS-59-01-016-15
Units	Maxtrix	SOIL	SOIL	SOIL	SOIL	SOIL	SOIL	SOIL	SOIL	SOIL	SOIL
Value (Q)	Sample ID	FD-59-WS-05	WS-59-04-010-4	FD-59-WS-05/WS-59-04-010-4	FD-59-WS-07	WS-59-01-015-13	FD-59-WS-07/WS-59-01-015-13	FD-59-WS-8	WS-59-01-016-15	FD-59-WS-8/WS-59-01-016-15	FD-59-WS-8/WS-59-01-016-15
	Sample Date	5/6/2004	5/6/2004	5/6/2004	5/6/2004	5/6/2004	5/6/2004	5/6/2004	5/6/2004	5/6/2004	5/6/2004
	QC Code	SA	DU	SA/DU	SA	DU	SA/DU	SA	DU	SA/DU	SA/DU
	Study ID	ENSR IRM	ENSR IRM	ENSR IRM	ENSR IRM	ENSR IRM	ENSR IRM	ENSR IRM	ENSR IRM	ENSR IRM	ENSR IRM
Aroclor-1248	UG/KG	17.5 U	18.5 U	18 U	19.5 U	19.5 U	19.5 U	19 U	19 U	19 U	19 U
Aroclor-1254	UG/KG	17.5 U	18.5 U	18 U	19.5 U	19.5 U	19.5 U	19 U	19 U	19 U	19 U
Aroclor-1260	UG/KG	17.5 U	18.5 U	18 U	19.5 U	19.5 U	19.5 U	19 U	19 U	19 U	19 U
Metals and Cyanide											
Aluminum	MG/KG	7790 J	11400 J	9595 J	10600	10900	10750	10800	10200	10500	10500
Antimony	MG/KG	1.2 J	2.2 J	1.7 J	1.75 UJ	14.3 J	8.025 J	1.7 UJ	1.75 UJ	1.725 UJ	1.725 UJ
Arsenic	MG/KG	4.6 J	6.5 J	5.55 J	4.4 J	5.8 J	5.1 J	4	4.6	4.3	4.3
Barium	MG/KG	45.8 J	81.6 J	63.7 J	97.8	109	103.4	83.3	83	83.15	83.15
Beryllium	MG/KG	0.38	0.59	0.485	0.36	0.5	0.43	0.28	0.29	0.285	0.285
Cadmium	MG/KG	0.25 J	0.38	0.315 J	0.36 J	0.41 J	0.385 J	0.69	0.59	0.64	0.64
Calcium	MG/KG	56300 J	57700	57000 J	29700	48800	39250	48000 J	81300 J	64650 J	64650 J
Chromium	MG/KG	12.4 J	16.9 J	14.65 J	17.8 J	20.7 J	19.25 J	17.1	16.8	16.95	16.95
Cobalt	MG/KG	7.4 J	9.9 J	8.65 J	9.1	11.5	10.3	9.6	9.2	9.4	9.4
Copper	MG/KG	20.2 J	25.5 J	22.85 J	23.6 J	42.1 J	32.85 J	24.3 J	22.2 J	23.25 J	23.25 J
Cyanide	MG/KG										
Iron	MG/KG	18500	23600	21050	20000	24200	22100	19200	18900	19050	19050
Lead	MG/KG	8.5 J	22.3 J	15.4 J	41.3 J	52.4 J	46.85 J	54 J	26 J	40 J	40 J
Magnesium	MG/KG	11000 J	7840 J	9420 J	5530 J	9820 J	7675 J	8600	7810	8205	8205
Manganese	MG/KG	370 J	529 J	449.5 J	390 J	1010 J	700 J	472	459	465.5	465.5
Mercury	MG/KG	0.05 J	0.27 J	0.16 J	0.05	0.06	0.055	0.09	0.06	0.075	0.075
Nickel	MG/KG	20.4 J	27 J	23.7 J	24.4 J	35.7 J	30.05 J	23.8	25.8	24.8	24.8
Potassium	MG/KG	843 J	1640 J	1241.5 J	1150	1140	1145	1110	1230	1170	1170
Selenium	MG/KG	0.18 U	0.225 U	0.2025 U	0.6 UJ	0.55 UJ	0.575 UJ	0.28 U	0.29 U	0.285 U	0.285 U
Silver	MG/KG	0.43 J	0.8	0.615 J	0.285 U	0.285 U	0.285 U	0.28 U	0.64 J	0.46 J	0.46 J
Sodium	MG/KG	133 J	119 J	126 J	142 J	240 J	191 J	182 J	414 J	298 J	298 J
Thallium	MG/KG	0.09 U	0.11 U	0.1 U	0.9 J	0.93 J	0.915 J	0.57 J	0.61 J	0.59 J	0.59 J
Vanadium	MG/KG	12.9 J	20.4 J	16.65 J	18.3	19.3	18.8	20.1	18.5	19.3	19.3
Zinc	MG/KG	51.2 J	75 J	63.1 J	145 J	137 J	141 J	74.3 J	64 J	69.15 J	69.15 J

Notes
1) Sample/Duplicate pairs were manually averaged,
Averging Procedure below
A - Non-Detects were half detection
limit, R were ignored
B - SA/DU chem values were then averaged
C - SA/DU Qualifiers were selected to
represent the discreet sample.
D - SA/DU sample ID were combined and are
marked with "SA/DU"

Table A-1B
SEAD-59 Soil Sample-Duplicate Merged Results
SEAD-59 AND SEAD-71 PHASE II RI REPORT
Seneca Army Depot Activity

Parameter	Facility	SEAD-59	SEAD-59	SEAD-59	SEAD-59	SEAD-59	SEAD-59	SEAD-59	SEAD-59	SEAD-59	SEAD-59
	Location ID	FD-71-CL-04	CL-59-01-F01	FD-71-CL-04/CL-59-01-F01	SB59-1	SB59-1	SB59-1	TP59-9-2	TP59-9-2	TP59-9-2	TP59-9-2
	Matrix	SOIL	SOIL	SOIL	SOIL	SOIL	SOIL	SOIL	SOIL	SOIL	SOIL
	Sample ID	FD-71-CL-04	CL-59-01-F01	FD-71-CL-04/CL-59-01-F01	SB59-1-08	SB59-1-04	SB59-1-08/SB59-1-04	59053	59052	59052/59053	59052
	Sample Date	5/6/2004	5/6/2004	5/6/2004	2/20/1994	2/20/1994	2/20/1994	10/13/1997	10/13/1997	10/13/1997	10/13/1997
	QC Code	SA	DU	SA/DU	DU	SA	SA/DU	DU	SA	SA/DU	SA/DU
	Study ID	ENSR IRM	ENSR IRM	ENSR IRM	ESI	ESI	ESI	RI PHASE 1 STEP 1	RI PHASE 1 STEP 1	RI PHASE 1 STEP 1	RI PHAS
	Units	Value (Q)	Value (Q)	Value (Q)	Value (Q)	Value (Q)	Value (Q)	Value (Q)	Value (Q)	Value (Q)	Value (Q)
Volatile Organic Compounds											
1,1,1-Trichloroethane	UG/KG	2.5 U	2.5 UJ	2.5 UJ		6.5 U	6.5 U		6 U		6 U
1,1,2,2-Tetrachloroethane	UG/KG	2.5 UJ	2.5 UJ	2.5 UJ		6.5 U	6.5 U		6 U		6 U
1,1,2-Trichloro-1,2,2-Trifluoroethane	UG/KG	2.5 UJ	2.5 UJ	2.5 UJ							
1,1,2-Trichloroethane	UG/KG	2.5 U	2.5 UJ	2.5 UJ		6.5 U	6.5 U		6 U		6 U
1,1-Dichloroethane	UG/KG	2.5 U	2.5 UJ	2.5 UJ		6.5 U	6.5 U		6 U		6 U
1,1-Dichloroethene	UG/KG	2.5 U	2.5 UJ	2.5 UJ		6.5 U	6.5 U		6 U		6 U
1,2,3-Trichloropropane	UG/KG										
1,2,4-Trichlorobenzene	UG/KG	2.5 UJ	2.5 UJ	2.5 UJ							
1,2-Dibromo-3-chloropropane	UG/KG	2.5 UJ	2.5 UJ	2.5 UJ							
1,2-Dibromoethane	UG/KG	2.5 U	2.5 UJ	2.5 UJ							
1,2-Dichlorobenzene	UG/KG	2.5 UJ	2.5 UJ	2.5 UJ							
1,2-Dichloroethane	UG/KG	2.5 U	2.5 UJ	2.5 UJ		6.5 U	6.5 U		6 U		6 U
1,2-Dichloroethene (total)	UG/KG					6.5 U	6.5 U		6 U		6 U
1,2-Dichloropropane	UG/KG	2.5 U	2.5 UJ	2.5 UJ		6.5 U	6.5 U		6 U		6 U
1,3-Dichlorobenzene	UG/KG	2.5 UJ	2.5 UJ	2.5 UJ							
1,3-Dichloropropane	UG/KG										
1,4-Dichlorobenzene	UG/KG	2.5 UJ	2.5 UJ	2.5 UJ							
Acetone	UG/KG	2.5 U	50 J	26.25 J		23.5 U	23.5 U		6 U		6 U
Benzene	UG/KG	2.5 U	1 J	1.75 J		6.5 U	6.5 U		6 U		6 U
Bromodichloromethane	UG/KG	2.5 U	2.5 UJ	2.5 UJ		6.5 U	6.5 U		6 U		6 U
Bromoform	UG/KG	2.5 U	2.5 UJ	2.5 UJ		6.5 U	6.5 U		6 U		6 U
Carbon disulfide	UG/KG	2.5 U	2.5 UJ	2.5 UJ		6.5 U	6.5 U		6 U		6 U
Carbon tetrachloride	UG/KG	2.5 U	2.5 UJ	2.5 UJ		6.5 U	6.5 U		6 U		6 U
Chlorobenzene	UG/KG	2.5 U	2.5 UJ	2.5 UJ		6.5 U	6.5 U		6 U		6 U
Chlorodibromomethane	UG/KG	2.5 U	2.5 UJ	2.5 UJ		6.5 U	6.5 U		6 U		6 U
Chloroethane	UG/KG	2.5 U	2.5 UJ	2.5 UJ		6.5 U	6.5 U		6 U		6 U
Chloroform	UG/KG	2.5 U	2.5 UJ	2.5 UJ		6.5 U	6.5 U		6 U		6 U
Cis-1,2-Dichloroethene	UG/KG	2.5 U	2.5 UJ	2.5 UJ							
Cis-1,3-Dichloropropene	UG/KG	2.5 U	2.5 UJ	2.5 UJ		6.5 U	6.5 U		6 U		6 U
Cyclohexane	UG/KG	2.5 U	2.5 UJ	2.5 UJ							
Dichlorodifluoromethane	UG/KG	2.5 UJ	2.5 UJ	2.5 UJ							
Ethyl benzene	UG/KG	2.5 U	2.5 UJ	2.5 UJ		6.5 U	6.5 U		6 U		6 U
Isopropylbenzene	UG/KG	2.5 U	2.5 UJ	2.5 UJ							
Meta/Para Xylene	UG/KG										
Methyl Acetate	UG/KG	2.5 U	2.5 UJ	2.5 UJ							
Methyl Tertbutyl Ether	UG/KG	2.5 U	2.5 UJ	2.5 UJ							
Methyl bromide	UG/KG	2.5 U	2.5 UJ	2.5 UJ		6.5 U	6.5 U		6 U		6 U
Methyl butyl ketone	UG/KG	2.5 U	2.5 UJ	2.5 UJ		6.5 U	6.5 U		6 U		6 U
Methyl chloride	UG/KG	2.5 U	2.5 UJ	2.5 UJ		6.5 U	6.5 U		6 U		6 U
Methyl cyclohexane	UG/KG	2.5 U	4 J	3.25 J							
Methyl ethyl ketone	UG/KG	2.5 U	2.5 UJ	2.5 UJ		7 U	7 U		6 U		6 U
Methyl isobutyl ketone	UG/KG	2.5 U	2.5 UJ	2.5 UJ		6.5 U	6.5 U		6 U		6 U
Methylene chloride	UG/KG	2.5 U	4 UJ	3.25 UJ		6.5 U	6.5 U		6 U		6 U
Ortho Xylene	UG/KG										
Styrene	UG/KG	2.5 U	2.5 UJ	2.5 UJ		6.5 U	6.5 U		6 U		6 U
Tetrachloroethene	UG/KG	2.5 U	2.5 UJ	2.5 UJ		6.5 U	6.5 U		6 U		6 U
Toluene	UG/KG	2.5 U	2 J	2.25 J		6.5 U	6.5 U		6 U		6 U
Total BTEX	MG/KG							1.25 U	1.25 U		1.25 U
Total Xylenes	UG/KG	2.5 UJ	2.5 UJ	2.5 UJ		6.5 U	6.5 U		6 U		6 U
Trans-1,2-Dichloroethene	UG/KG	2.5 U	2.5 UJ	2.5 UJ							
Trans-1,3-Dichloropropene	UG/KG	2.5 U	2.5 UJ	2.5 UJ		6.5 U	6.5 U		6 U		6 U

Table A-1B
SEAD-59 Soil Sample-Duplicate Merged Results
SEAD-59 AND SEAD-71 PHASE II RI REPORT
Seneca Army Depot Activity

Parameter	Units	Facility	SEAD-59	SEAD-59	SEAD-59	SEAD-59	SEAD-59	SEAD-59	SEAD-59	SEAD-59	SEAD-59	SEAD-59
		Location ID	FD-71-CL-04	CL-59-01-F01	FD-71-CL-04/CL-59-01-F01	SB59-1	SB59-1	SB59-1	TP59-9-2	TP59-9-2	TP59-9-2	
		Maxtrix	SOIL	SOIL	SOIL	SOIL	SOIL	SOIL	SOIL	SOIL	SOIL	SOIL
		Sample ID	FD-71-CL-04	CL-59-01-F01	FD-71-CL-04/CL-59-01-F01	SB59-1-08	SB59-1-04	SB59-1-08/SB59-1-04	59053	59052	59052/59053	59053
		Sample Date	5/6/2004	5/6/2004	5/6/2004	2/20/1994	2/20/1994	2/20/1994	10/13/1997	10/13/1997	10/13/1997	10/13/1997
		QC Code	SA	DU	SA/DU	DU	SA	SA/DU	DU	SA	SA/DU	SA/DU
		Study ID	ENSR IRM	ENSR IRM	ENSR IRM	ESI	ESI	ESI	RI PHASE 1 STEP 1	RI PHASE 1 STEP 1	RI PHASE 1 STEP 1	RI PHAS
		Value (Q)	Value (Q)	Value (Q)	Value (Q)	Value (Q)	Value (Q)	Value (Q)	Value (Q)	Value (Q)	Value (Q)	Value (Q)
Trichloroethene	UG/KG	2.5 U	2.5 UJ	2.5 UJ	2.5 UJ			6.5 U			6 U	
Trichlorofluoromethane	UG/KG	2.5 UJ	2.5 UJ	2.5 UJ	2.5 UJ							
Vinyl chloride	UG/KG	2.5 U	2.5 UJ	2.5 UJ	2.5 UJ		6.5 U	6.5 U		6 U		6 U
Semivolatile Organic Compounds												
1,1'-Biphenyl	UG/KG	180 U	180 U	180 U	180 U							
1,2,4-Trichlorobenzene	UG/KG					950 U	210 U	580 U		75 U		75 U
1,2-Dichlorobenzene	UG/KG					950 U	210 U	580 U		75 U		75 U
1,3-Dichlorobenzene	UG/KG					950 U	210 U	580 U		75 U		75 U
1,4-Dichlorobenzene	UG/KG					950 U	210 U	580 U		75 U		75 U
2,2'-oxybis(1-Chloropropane)	UG/KG	180 U	180 U	180 U	180 U	950 U	210 U	580 U				
2,4,5-Trichlorophenol	UG/KG	450 U	455 U	452.5 U	452.5 U	2350 U	500 U	1425 U		185 U		185 U
2,4,6-Trichlorophenol	UG/KG	180 U	180 U	180 U	180 U	950 U	210 U	580 U		75 U		75 U
2,4-Dichlorophenol	UG/KG	180 U	180 U	180 U	180 U	950 U	210 U	580 U		75 U		75 U
2,4-Dimethylphenol	UG/KG	180 U	180 U	180 U	180 U	950 U	210 U	580 U		75 U		75 U
2,4-Dinitrophenol	UG/KG	450 UJ	455 U	452.5 UJ	452.5 UJ	2350 U	500 U	1425 U		185 U		185 U
2,4-Dinitrotoluene	UG/KG	180 U	180 U	180 U	180 U	950 U	210 U	580 U		75 U		75 U
2,6-Dinitrotoluene	UG/KG	180 U	180 U	180 U	180 U	950 U	210 U	580 U		75 U		75 U
2-Chloronaphthalene	UG/KG	180 U	180 U	180 U	180 U	950 U	210 U	580 U		75 U		75 U
2-Chlorophenol	UG/KG	180 U	180 U	180 U	180 U	950 U	210 U	580 U		75 U		75 U
2-Methylnaphthalene	UG/KG	180 U	180 U	180 U	180 U	150 J	110 J	130 J		10 J		10 J
2-Methylphenol	UG/KG	180 U	180 U	180 U	180 U	950 U	210 U	580 U		75 U		75 U
2-Nitroaniline	UG/KG	450 U	455 U	452.5 U	452.5 U	2350 U	500 U	1425 U		185 U		185 U
2-Nitrophenol	UG/KG	180 U	180 U	180 U	180 U	950 U	210 U	580 U		75 U		75 U
3,3'-Dichlorobenzidine	UG/KG	180 U	180 U	180 U	180 U	950 U	210 U	580 U		75 U		75 U
3-Nitroaniline	UG/KG	450 U	455 U	452.5 U	452.5 U	2350 U	500 U	1425 U		185 U		185 U
4,6-Dinitro-2-methylphenol	UG/KG	450 UJ	455 U	452.5 UJ	452.5 UJ	2350 U	500 U	1425 U		185 U		185 U
4-Bromophenyl phenyl ether	UG/KG	180 U	180 U	180 U	180 U	950 U	210 U	580 U		75 U		75 U
4-Chloro-3-methylphenol	UG/KG	180 U	180 U	180 U	180 U	950 U	210 U	580 U		75 U		75 U
4-Chloroaniline	UG/KG	180 U	180 U	180 U	180 U	950 U	210 U	580 U		75 U		75 U
4-Chlorophenyl phenyl ether	UG/KG	180 U	180 U	180 U	180 U	950 U	210 U	580 U		75 U		75 U
4-Methylphenol	UG/KG	180 U	180 U	180 U	180 U	950 U	210 U	580 U		75 U		75 U
4-Nitroaniline	UG/KG	450 U	455 U	452.5 U	452.5 U	2350 U	500 U	1425 U		185 U		185 U
4-Nitrophenol	UG/KG	450 U	455 U	452.5 U	452.5 U	2350 U	500 U	1425 U		185 U		185 U
Acenaphthene	UG/KG	49 J	180 U	114.5 J	114.5 J	390 J	160 J	275 J		44 J		44 J
Acenaphthylene	UG/KG	180 U	180 U	180 U	180 U	640 J	120 J	380 J		7.9 J		7.9 J
Acetophenone	UG/KG	180 U	180 U	180 U	180 U							
Aniline	UG/KG											
Anthracene	UG/KG	59 J	180 U	119.5 J	119.5 J	1400 J	270 J	835 J		88 J		88 J
Atrazine	UG/KG	180 U	180 U	180 U	180 U							
Benzaldehyde	UG/KG	180 U	180 U	180 U	180 U							
Benzo(a)anthracene	UG/KG	140 J	180 U	160 J	160 J	5000	780	2890		320		320
Benzo(a)pyrene	UG/KG	110 J	180 U	145 J	145 J	5500 J	870	3185 J		340		340
Benzo(b)fluoranthene	UG/KG	130 J	180 U	155 J	155 J	5100 J	730	2915 J		320		320
Benzo(ghi)perylene	UG/KG	38 J	180 U	109 J	109 J	2400 J	430	1415 J		210		210
Benzo(k)fluoranthene	UG/KG	77 J	180 U	128.5 J	128.5 J	6100 J	800	3450 J		300		300
Benzoic Acid	UG/KG											
Bis(2-Chloroethoxy)methane	UG/KG	180 U	180 U	180 U	180 U	950 U	210 U	580 U		75 U		75 U
Bis(2-Chloroethyl)ether	UG/KG	180 U	180 U	180 U	180 U	950 U	210 U	580 U		75 U		75 U
Bis(2-Chloroisopropyl)ether	UG/KG									75 U		75 U
Bis(2-Ethylhexyl)phthalate	UG/KG	180 U	180 U	180 U	180 U	950 U	80 J	515 J		41 J		41 J
Butylbenzylphthalate	UG/KG	180 U	180 U	180 U	180 U	950 U	210 U	580 U		75 U		75 U
Caprolactam	UG/KG	180 U	180 U	180 U	180 U							

Table A-1B
SEAD-59 Soil Sample-Duplicate Merged Results
SEAD-59 AND SEAD-71 PHASE II RI REPORT
Seneca Army Depot Activity

	Facility	SEAD-59	SEAD-59	SEAD-59	SEAD-59	SEAD-59	SEAD-59	SEAD-59	SEAD-59	SEAD-59	SEAD-59
	Location ID	FD-71-CL-04	CL-59-01-F01	FD-71-CL-04/CL-59-01-F01	SB59-1	SB59-1	SB59-1	TP59-9-2	TP59-9-2	TP59-9-2	TP59-9-2
	Maxtrix	SOIL	SOIL	SOIL	SOIL	SOIL	SOIL	SOIL	SOIL	SOIL	SOIL
	Sample ID	FD-71-CL-04	CL-59-01-F01	FD-71-CL-04/CL-59-01-F01	SB59-1-08	SB59-1-04	SB59-1-08/SB59-1-04	59053	59052	59052/59053	59052/59053
	Sample Date	5/6/2004	5/6/2004	5/6/2004	2/20/1994	2/20/1994	2/20/1994	10/13/1997	10/13/1997	10/13/1997	10/13/1997
	QC Code	SA	DU	SA/DU	DU	SA	SA/DU	DU	SA	SA/DU	SA/DU
	Study ID	ENSR IRM	ENSR IRM	ENSR IRM	ESI	ESI	ESI	RI PHASE 1 STEP 1	RI PHASE 1 STEP 1	RI PHASE 1 STEP 1	RI PHAS
Parameter	Units	Value (Q)	Value (Q)	Value (Q)	Value (Q)	Value (Q)	Value (Q)	Value (Q)	Value (Q)	Value (Q)	Value (Q)
Carbazole	UG/KG	180 U	180 U	180 U	180 U	1300 J	210 J	755 J	120 J	120 J	120 J
Chrysene	UG/KG	150 J	180 U	165 J	5100	930	3015		360	360	360
Di-n-butylphthalate	UG/KG	180 U	180 U	180 U	950 U	30 J	490 J		80 J	80 J	80 J
Di-n-octylphthalate	UG/KG	180 U	180 U	180 U	950 UJ	210 U	580 UJ		75 U	75 U	75 U
Dibenz(a,h)anthracene	UG/KG	180 U	180 U	180 U	950 UJ	210 U	580 UJ		84 J	84 J	84 J
Dibenzofuran	UG/KG	180 U	180 U	180 U	280 J	110 J	195 J		21 J	21 J	21 J
Diethyl phthalate	UG/KG	180 U	180 U	180 U	950 U	210 U	580 U		75 U	75 U	75 U
Dimethylphthalate	UG/KG	180 U	180 U	180 U	950 U	210 U	580 U		75 U	75 U	75 U
Fluoranthene	UG/KG	320 J	180 U	250 J	9900	1500	5700		790	790	790
Fluorene	UG/KG	180 U	180 U	180 U	730 J	200 J	465 J		46 J	46 J	46 J
Hexachlorobenzene	UG/KG	180 U	180 U	180 U	950 U	210 U	580 U		75 U	75 U	75 U
Hexachlorobutadiene	UG/KG	180 U	180 U	180 U	950 U	210 U	580 U		75 U	75 U	75 U
Hexachlorocyclopentadiene	UG/KG	180 U	180 U	180 U	950 U	210 U	580 U		75 U	75 U	75 U
Hexachloroethane	UG/KG	180 U	180 U	180 U	950 U	210 U	580 U		75 U	75 U	75 U
Indeno(1,2,3-cd)pyrene	UG/KG	43 J	180 U	111.5 J	2200 J	400 J	1300 J		200	200	200
Isophorone	UG/KG	180 U	180 U	180 U	950 U	210 U	580 U		75 U	75 U	75 U
N-Nitrosodiphenylamine	UG/KG	180 U	180 U	180 U	950 U	210 U	580 U		75 U	75 U	75 U
N-Nitrosodipropylamine	UG/KG	180 U	180 U	180 U	950 U	210 U	580 U		75 U	75 U	75 U
Naphthalene	UG/KG	180 U	180 U	180 U	140 J	160 J	150 J		12 J	12 J	12 J
Nitrobenzene	UG/KG	180 U	180 U	180 U	950 U	210 U	580 U		75 U	75 U	75 U
Pentachlorophenol	UG/KG	450 U	455 U	452.5 U	2350 U	500 U	1425 U		185 U	185 U	185 U
Phenanthrene	UG/KG	240 J	180 U	210 J	6200	980	3590		460	460	460
Phenol	UG/KG	180 U	180 U	180 U	950 U	210 U	580 U		75 U	75 U	75 U
Pyrene	UG/KG	280 J	180 U	230 J	13000	1400	7200		550	550	550
Pyridine	UG/KG										
Total Unknown PAHs as SV	MG/KG							4.8	22	13.4	
Pesticides/PCBs											
4,4'-DDD	UG/KG	1.8 U	1.8 U	1.8 U		36	36		3.4 J	3.4 J	3.4 J
4,4'-DDE	UG/KG	1.8 U	1.8 U	1.8 U		25	25		80	80	80
4,4'-DDT	UG/KG	1.8 U	1.8 U	1.8 U		25	25		36	36	36
Aldrin	UG/KG	0.95 U	0.95 U	0.95 U		1.1 U	1.1 U		1 U	1 U	1 U
Alpha-BHC	UG/KG	0.95 U	0.95 U	0.95 U		1.1 U	1.1 U		1 U	1 U	1 U
Alpha-Chlordane	UG/KG	0.95 U	0.95 U	0.95 U		1.1 U	1.1 U		1 U	1 U	1 U
Beta-BHC	UG/KG	0.95 U	0.95 U	0.95 U		1.1 U	1.1 U		1 U	1 U	1 U
Delta-BHC	UG/KG	0.95 U	0.95 U	0.95 U		1.1 U	1.1 U		1 U	1 U	1 U
Dieldrin	UG/KG	1.8 U	1.8 U	1.8 U		2.1 U	2.1 U		1.9 U	1.9 U	1.9 U
Endosulfan I	UG/KG	0.95 U	0.95 U	0.95 U		1.1 U	1.1 U		1 U	1 U	1 U
Endosulfan II	UG/KG	1.8 U	1.8 U	1.8 U		2.1 U	2.1 U		1.9 U	1.9 U	1.9 U
Endosulfan sulfate	UG/KG	1.8 U	1.8 U	1.8 U		2.1 U	2.1 U		1.9 U	1.9 U	1.9 U
Endrin	UG/KG	1.8 U	1.8 U	1.8 U		2.1 U	2.1 U		1.9 U	1.9 U	1.9 U
Endrin aldehyde	UG/KG	1.8 U	1.8 U	1.8 U		2.1 U	2.1 U		1.9 U	1.9 U	1.9 U
Endrin ketone	UG/KG	1.8 U	1.8 U	1.8 U		2.1 U	2.1 U		1.9 U	1.9 U	1.9 U
Gamma-BHC/Lindane	UG/KG	0.95 U	0.95 U	0.95 U		1.1 U	1.1 U		1 U	1 U	1 U
Gamma-Chlordane	UG/KG	0.95 U	0.95 U	0.95 U		1.1 U	1.1 U		1 U	1 U	1 U
Heptachlor	UG/KG	0.95 U	0.95 U	0.95 U		1.1 U	1.1 U		1 U	1 U	1 U
Heptachlor epoxide	UG/KG	0.95 U	0.95 U	0.95 U		1.1 U	1.1 U		3 J	3 J	3 J
Methoxychlor	UG/KG	9.5 U	9.5 U	9.5 U		11 U	11 U		10 U	10 U	10 U
Toxaphene	UG/KG	95 U	95 U	95 U		110 U	110 U		100 U	100 U	100 U
Aroclor-1016	UG/KG	18.5 U	18 U	18.25 U		21 U	21 U		19 U	19 U	19 U
Aroclor-1221	UG/KG	18.5 U	18 U	18.25 U		43 U	43 U		39 U	39 U	39 U
Aroclor-1232	UG/KG	18.5 U	18 U	18.25 U		21 U	21 U		19 U	19 U	19 U
Aroclor-1242	UG/KG	18.5 U	18 U	18.25 U		21 U	21 U		19 U	19 U	19 U

Table A-1B
SEAD-59 Soil Sample-Duplicate Merged Results
SEAD-59 AND SEAD-71 PHASE II RI REPORT
Seneca Army Depot Activity

Parameter	Facility	SEAD-59	SEAD-59	SEAD-59	SEAD-59	SEAD-59	SEAD-59	SEAD-59	SEAD-59	SEAD-59	SEAD-59
	Location ID	FD-71-CL-04	CL-59-01-F01	FD-71-CL-04/CL-59-01-F01	SB59-1	SB59-1	SB59-1	TP59-9-2	TP59-9-2	TP59-9-2	TP59-9-2
Units	Maxtrix	SOIL	SOIL	SOIL	SOIL	SOIL	SOIL	SOIL	SOIL	SOIL	SOIL
Value (Q)	Sample ID	FD-71-CL-04	CL-59-01-F01	FD-71-CL-04/CL-59-01-F01	SB59-1-08	SB59-1-04	SB59-1-08/SB59-1-04	59053	59052	59052/59053	59052
Value (Q)	Sample Date	5/6/2004	5/6/2004	5/6/2004	2/20/1994	2/20/1994	2/20/1994	10/13/1997	10/13/1997	10/13/1997	10/13/1997
Value (Q)	QC Code	SA	DU	SA/DU	DU	SA	SA/DU	DU	SA	SA/DU	SA/DU
Value (Q)	Study ID	ENSR IRM	ENSR IRM	ENSR IRM	ESI	ESI	ESI	RI PHASE 1 STEP 1	RI PHASE 1 STEP 1	RI PHASE 1 STEP 1	RI PHAS
UG/KG	Aroclor-1248	18.5 U	18 U	18.25 U	21 U	21 U	21 U	19 U	19 U	19 U	19 U
UG/KG	Aroclor-1254	18.5 U	18 U	18.25 U	21 U	21 U	21 U	19 U	19 U	19 U	19 U
UG/KG	Aroclor-1260	18.5 U	18 U	18.25 U	21 U	21 U	21 U	19 U	19 U	19 U	19 U
Metals and Cyanide											
MG/KG	Aluminum	7920 J	11900 J	9910 J	13000 J	13000 J	13000 J	10700 J	10700 J	10700 J	10700 J
MG/KG	Antimony	1.1 J	1.1 J	1.1 J	0.74 J	0.74 J	0.74 J	0.3 UJ	0.3 UJ	0.3 UJ	0.3 UJ
MG/KG	Arsenic	4.8	6.4	5.6	4.4 J	4.4 J	4.4 J	4.5	4.5	4.5	4.5
MG/KG	Barium	51 J	113 J	82 J	108 J	108 J	108 J	77.1	77.1	77.1	77.1
MG/KG	Beryllium	0.4	0.62	0.51	0.58 J	0.58 J	0.58 J	0.4	0.4	0.4	0.4
MG/KG	Cadmium	0.16 J	0.24 J	0.2 J	0.37 J	0.37 J	0.37 J	0.04 U	0.04 U	0.04 U	0.04 U
MG/KG	Calcium	51800 J	20200 J	36000 J	83700 J	83700 J	83700 J	25900	25900	25900	25900
MG/KG	Chromium	12.6 J	17.8 J	15.2 J	18.4 J	18.4 J	18.4 J	15.8	15.8	15.8	15.8
MG/KG	Cobalt	7.5 J	9.5 J	8.5 J	7.1 J	7.1 J	7.1 J	8.9	8.9	8.9	8.9
MG/KG	Copper	19.4 J	25 J	22.2 J	32.9 J	32.9 J	32.9 J	21.1	21.1	21.1	21.1
MG/KG	Cyanide				0.315 U	0.315 U	0.315 U	0.355 U	0.355 U	0.355 U	0.355 U
MG/KG	Iron	14600	23000	18800	18300 J	18300 J	18300 J	19500	19500	19500	19500
MG/KG	Lead	17.1 J	11 J	14.05 J	38.4 J	38.4 J	38.4 J	29.5 J	29.5 J	29.5 J	29.5 J
MG/KG	Magnesium	10700 J	5860 J	8280 J	8610 J	8610 J	8610 J	5940 J	5940 J	5940 J	5940 J
MG/KG	Manganese	405 J	509 J	457 J	418 J	418 J	418 J	422 J	422 J	422 J	422 J
MG/KG	Mercury	0.03	0.04	0.035	0.16 J	0.16 J	0.16 J	0.09	0.09	0.09	0.09
MG/KG	Nickel	21.4 J	26.8 J	24.1 J	23 J	23 J	23 J	23.1	23.1	23.1	23.1
MG/KG	Potassium	854	1170	1012	2290 J	2290 J	2290 J	1180	1180	1180	1180
MG/KG	Selenium	0.21 U	0.2 U	0.205 U	1 J	1 J	1 J	0.415 U	0.415 U	0.415 U	0.415 U
MG/KG	Silver	0.38 J	0.98	0.68 J	0.075 U	0.075 U	0.075 U	0.115 U	0.115 U	0.115 U	0.115 U
MG/KG	Sodium	113	113	113	353 J	353 J	353 J	44.8 U	44.8 U	44.8 U	44.8 U
MG/KG	Thallium	0.105 U	0.1 U	0.1025 U	0.135 U	0.135 U	0.135 U	0.6 U	0.6 U	0.6 U	0.6 U
MG/KG	Vanadium	12.6 J	21.8 J	17.2 J	24.8 J	24.8 J	24.8 J	17.3	17.3	17.3	17.3
MG/KG	Zinc	52.3	63.1	57.7	116 J	116 J	116 J	68.8 J	68.8 J	68.8 J	68.8 J

Notes

- 1) Sample/Duplicate pairs were manually averaged, Averging Procedure below
- A - Non-Detects were half detection limit, R were ignored
- B - SA/DU chem values were then averaged
- C - SA/DU Qualifiers were selected to represent the discreet sample.
- D - SA/DU sample ID were combined and are marked with "SA/DU"

Table A-1B
SEAD-59 Soil Sample-Duplicate Merged Results
SEAD-59 AND SEAD-71 PHASE II RI REPORT
Seneca Army Depot Activity

Parameter	Facility	SEAD-59	SEAD-59	SEAD-59	SEAD-59	SEAD-59	SEAD-59	SEAD-59	SEAD-59	SEAD-59
	Location ID	SB59-9	SB59-9	SB59-9	SB59-17	SB59-17	SB59-17	SB59-20	SB59-20	SB59-20
	Maxtrix	SOIL	SOIL	SOIL	SOIL	SOIL	SOIL	SOIL	SOIL	SOIL
	Sample ID	59085	59089	59085/59089	59131	59068	59068/59131	59107	59066	59066/59107
	Sample Date	10/22/1997	10/22/1997	10/22/1997	10/23/1997	10/23/1997	10/23/1997	10/22/1997	10/22/1997	10/22/1997
	QC Code	SA	DU	SA/DU	DU	SA	SA/DU	DU	SA	SA/DU
	Study ID	E 1 STEP 1	RI PHASE 1 STEP 1	RI PHASE 1 STEP 1	RI PHASE 1 STEP 1	RI PHASE 1 STEP 1	RI PHASE 1 STEP 1	RI PHASE 1 STEP 1	RI PHASE 1 STEP 1	RI PHASE 1 STEP 1
	Units	Value (Q)	Value (Q)	Value (Q)	Value (Q)	Value (Q)	Value (Q)	Value (Q)	Value (Q)	Value (Q)
Volatile Organic Compounds										
1,1,1-Trichloroethane	UG/KG				30 U	5.5 U	17.75 U		5.5 U	5.5 U
1,1,2,2-Tetrachloroethane	UG/KG				30 U	5.5 U	17.75 U		5.5 U	5.5 U
1,1,2-Trichloro-1,2,2-Trifluoroethane	UG/KG									
1,1,2-Trichloroethane	UG/KG				30 U	5.5 U	17.75 U		5.5 U	5.5 U
1,1-Dichloroethane	UG/KG				30 U	5.5 U	17.75 U		5.5 U	5.5 U
1,1-Dichloroethene	UG/KG				30 U	5.5 U	17.75 U		5.5 U	5.5 U
1,2,3-Trichloropropane	UG/KG									
1,2,4-Trichlorobenzene	UG/KG									
1,2-Dibromo-3-chloropropane	UG/KG									
1,2-Dibromoethane	UG/KG									
1,2-Dichlorobenzene	UG/KG									
1,2-Dichloroethane	UG/KG				30 U	5.5 U	17.75 U		5.5 U	5.5 U
1,2-Dichloroethene (total)	UG/KG				30 U	5.5 U	17.75 U		5.5 U	5.5 U
1,2-Dichloropropane	UG/KG				30 U	5.5 U	17.75 U		5.5 U	5.5 U
1,3-Dichlorobenzene	UG/KG									
1,3-Dichloropropane	UG/KG									
1,4-Dichlorobenzene	UG/KG									
Acetone	UG/KG				30 U	5.5 U	17.75 U		5.5 U	5.5 U
Benzene	UG/KG				6 J	5.5 U	5.75 J		5.5 U	5.5 U
Bromodichloromethane	UG/KG				30 U	5.5 U	17.75 U		5.5 U	5.5 U
Bromoform	UG/KG				30 U	5.5 U	17.75 U		5.5 U	5.5 U
Carbon disulfide	UG/KG				30 U	5.5 U	17.75 U		5.5 U	5.5 U
Carbon tetrachloride	UG/KG				30 U	5.5 U	17.75 U		5.5 U	5.5 U
Chlorobenzene	UG/KG				30 U	5.5 U	17.75 U		5.5 U	5.5 U
Chlorodibromomethane	UG/KG				30 U	5.5 U	17.75 U		5.5 U	5.5 U
Chloroethane	UG/KG				30 U	5.5 U	17.75 U		5.5 U	5.5 U
Chloroform	UG/KG				30 U	5.5 U	17.75 U		5.5 U	5.5 U
Cis-1,2-Dichloroethene	UG/KG									
Cis-1,3-Dichloropropene	UG/KG				30 U	5.5 U	17.75 U		5.5 U	5.5 U
Cyclohexane	UG/KG									
Dichlorodifluoromethane	UG/KG									
Ethyl benzene	UG/KG				14 J	5.5 U	9.75 J		5.5 U	5.5 U
Isopropylbenzene	UG/KG									
Meta/Para Xylene	UG/KG									
Methyl Acetate	UG/KG									
Methyl Tertbutyl Ether	UG/KG									
Methyl bromide	UG/KG				30 U	5.5 U	17.75 U		5.5 U	5.5 U
Methyl butyl ketone	UG/KG				30 U	5.5 U	17.75 U		5.5 U	5.5 U
Methyl chloride	UG/KG				30 U	5.5 U	17.75 U		5.5 U	5.5 U
Methyl cyclohexane	UG/KG									
Methyl ethyl ketone	UG/KG				30 U	5.5 U	17.75 U		5.5 U	5.5 U
Methyl isobutyl ketone	UG/KG				30 U	5.5 U	17.75 U		5.5 U	5.5 U
Methylene chloride	UG/KG				30 U	5.5 U	17.75 U		5.5 U	5.5 U
Ortho Xylene	UG/KG									
Styrene	UG/KG				30 U	5.5 U	17.75 U		5.5 U	5.5 U
Tetrachloroethene	UG/KG				30 U	5.5 U	17.75 U		5.5 U	5.5 U
Toluene	UG/KG				16 J	5.5 U	10.75 J		5.5 U	5.5 U
Total BTEX	MG/KG	1.25 U	4.1	2.675 J		5.2	5.2	1.25 U	4	2.625 J
Total Xylenes	UG/KG				140	5.5 U	72.75 J		5.5 U	5.5 U
Trans-1,2-Dichloroethene	UG/KG									
Trans-1,3-Dichloropropene	UG/KG				30 U	5.5 U	17.75 U		5.5 U	5.5 U

Table A-1B
SEAD-59 Soil Sample-Duplicate Merged Results
SEAD-59 AND SEAD-71 PHASE II RI REPORT
Seneca Army Depot Activity

Parameter	Units	SEAD-59	SEAD-59	SEAD-59	SEAD-59	SEAD-59	SEAD-59	SEAD-59	SEAD-59	SEAD-59
		SB59-9	SB59-9	SB59-9	SB59-17	SB59-17	SB59-17	SB59-20	SB59-20	SB59-20
Maxtrix	SOIL	SOIL	SOIL	SOIL	SOIL	SOIL	SOIL	SOIL	SOIL	SOIL
Sample ID	59085	59089	59085/59089	59131	59068	59068/59131	59107	59066	59066/59107	
Sample Date	10/22/1997	10/22/1997	10/22/1997	10/23/1997	10/23/1997	10/23/1997	10/22/1997	10/22/1997	10/22/1997	
QC Code	SA	DU	SA/DU	DU	SA	SA/DU	DU	SA	SA/DU	
Study ID	E 1 STEP 1	RI PHASE 1 STEP 1	RI PHASE 1 STEP 1	RI PHASE 1 STEP 1	RI PHASE 1 STEP 1	RI PHASE 1 STEP 1	RI PHASE 1 STEP 1	RI PHASE 1 STEP 1	RI PHASE 1 STEP 1	RI PHASE 1 STEP 1
Value (Q)	Value (Q)	Value (Q)	Value (Q)	Value (Q)	Value (Q)	Value (Q)	Value (Q)	Value (Q)	Value (Q)	Value (Q)
Trichloroethene	UG/KG				30 U	5.5 U			5.5 U	5.5 U
Trichlorofluoromethane	UG/KG									
Vinyl chloride	UG/KG				30 U	5.5 U		17.75 U		
Semivolatile Organic Compounds										
1,1'-Biphenyl	UG/KG									
1,2,4-Trichlorobenzene	UG/KG				37.5 U	37.5 U		37.5 U	33 U	33 U
1,2-Dichlorobenzene	UG/KG				37.5 U	37.5 U		37.5 U	33 U	33 U
1,3-Dichlorobenzene	UG/KG				37.5 U	37.5 U		37.5 U	33 U	33 U
1,4-Dichlorobenzene	UG/KG				37.5 U	37.5 U		37.5 U	33 U	33 U
2,2'-oxybis(1-Chloropropane)	UG/KG									
2,4,5-Trichlorophenol	UG/KG				90 U	90 U		90 U	80 U	80 U
2,4,6-Trichlorophenol	UG/KG				37.5 U	37.5 U		37.5 U	33 UJ	33 UJ
2,4-Dichlorophenol	UG/KG				37.5 U	37.5 U		37.5 U	33 U	33 U
2,4-Dimethylphenol	UG/KG				37.5 U	37.5 U		37.5 U	33 U	33 U
2,4-Dinitrophenol	UG/KG				90 U	90 U		90 U	80 UJ	80 UJ
2,4-Dinitrotoluene	UG/KG				37.5 U	37.5 U		37.5 U	33 U	33 U
2,6-Dinitrotoluene	UG/KG				37.5 U	37.5 U		37.5 U	33 U	33 U
2-Chloronaphthalene	UG/KG				37.5 U	37.5 U		37.5 U	33 U	33 U
2-Chlorophenol	UG/KG				37.5 U	37.5 U		37.5 U	33 U	33 U
2-Methylnaphthalene	UG/KG				18 J	22 J		20 J	14 J	14 J
2-Methylphenol	UG/KG				37.5 U	37.5 U		37.5 U	33 U	33 U
2-Nitroaniline	UG/KG				90 U	90 U		90 U	80 U	80 U
2-Nitrophenol	UG/KG				37.5 U	37.5 U		37.5 U	33 U	33 U
3,3'-Dichlorobenzidine	UG/KG				37.5 U	37.5 U		37.5 U	33 UJ	33 UJ
3-Nitroaniline	UG/KG				90 U	90 U		90 U	80 UJ	80 UJ
4,6-Dinitro-2-methylphenol	UG/KG				90 U	90 U		90 U	80 U	80 U
4-Bromophenyl phenyl ether	UG/KG				37.5 U	37.5 U		37.5 U	33 U	33 U
4-Chloro-3-methylphenol	UG/KG				37.5 U	37.5 U		37.5 U	33 U	33 U
4-Chloroaniline	UG/KG				37.5 U	37.5 U		37.5 U	33 UJ	33 UJ
4-Chlorophenyl phenyl ether	UG/KG				37.5 U	37.5 U		37.5 U	33 U	33 U
4-Methylphenol	UG/KG				37.5 U	37.5 U		37.5 U	33 U	33 U
4-Nitroaniline	UG/KG				90 U	90 U		90 U	80 U	80 U
4-Nitrophenol	UG/KG				90 U	90 U		90 U	80 U	80 U
Acenaphthene	UG/KG				11 J	16 J		13.5 J	6.1 J	6.1 J
Acenaphthylene	UG/KG				37.5 U	4.6 J		21.05 J	33 U	33 U
Acetophenone	UG/KG									
Aniline	UG/KG									
Anthracene	UG/KG				16 J	35 J		25.5 J	8.4 J	8.4 J
Atrazine	UG/KG									
Benzaldehyde	UG/KG									
Benzo(a)anthracene	UG/KG				23 J	71 J		47 J	20 J	20 J
Benzo(a)pyrene	UG/KG				18 J	54 J		36 J	22 J	22 J
Benzo(b)fluoranthene	UG/KG				20 J	56 J		38 J	19 J	19 J
Benzo(ghi)perylene	UG/KG				10 J	35 J		22.5 J	22 J	22 J
Benzo(k)fluoranthene	UG/KG				20 J	66 J		43 J	20 J	20 J
Benzoic Acid	UG/KG									
Bis(2-Chloroethoxy)methane	UG/KG				37.5 U	37.5 U		37.5 U	33 U	33 U
Bis(2-Chloroethyl)ether	UG/KG				37.5 U	37.5 U		37.5 U	33 U	33 U
Bis(2-Chloroisopropyl)ether	UG/KG				37.5 U	37.5 U		37.5 U	33 U	33 U
Bis(2-Ethylhexyl)phthalate	UG/KG				15 J	26 J		20.5 J	16 J	16 J
Butylbenzylphthalate	UG/KG				37.5 U	37.5 U		37.5 U	33 U	33 U
Caprolactam	UG/KG									

Table A-1B
SEAD-59 Soil Sample-Duplicate Merged Results
SEAD-59 AND SEAD-71 PHASE II RI REPORT
Seneca Army Depot Activity

	Facility	SEAD-59	SEAD-59	SEAD-59	SEAD-59	SEAD-59	SEAD-59	SEAD-59	SEAD-59	SEAD-59	SEAD-59
	Location ID	SB59-9	SB59-9	SB59-9	SB59-17	SB59-17	SB59-17	SB59-20	SB59-20	SB59-20	SB59-20
	Maxtrix	SOIL	SOIL	SOIL	SOIL	SOIL	SOIL	SOIL	SOIL	SOIL	SOIL
	Sample ID	59085	59089	59085/59089	59131	59068	59068/59131	59107	59066	59066/59107	
	Sample Date	10/22/1997	10/22/1997	10/22/1997	10/23/1997	10/23/1997	10/23/1997	10/22/1997	10/22/1997	10/22/1997	10/22/1997
	QC Code	SA	DU	SA/DU	DU	SA	SA/DU	DU	SA	SA/DU	
	Study ID	E 1 STEP 1	RI PHASE 1 STEP 1	RI PHASE 1 STEP 1	RI PHASE 1 STEP 1	RI PHASE 1 STEP 1	RI PHASE 1 STEP 1	RI PHASE 1 STEP 1	RI PHASE 1 STEP 1	RI PHASE 1 STEP 1	RI PHASE 1 STEP 1
Parameter	Units	Value (Q)	Value (Q)	Value (Q)	Value (Q)	Value (Q)	Value (Q)	Value (Q)	Value (Q)	Value (Q)	Value (Q)
Carbazole	UG/KG		14 J		29 J		21.5 J		11 J		11 J
Chrysene	UG/KG		22 J		72 J		47 J		25 J		25 J
Di-n-butylphthalate	UG/KG		5.1 J		5 J		5.05 J		5.5 J		5.5 J
Di-n-octylphthalate	UG/KG		37.5 U		37.5 U		37.5 U		33 U		33 U
Dibenz(a,h)anthracene	UG/KG		4.8 J		13 J		8.9 J		4.7 J		4.7 J
Dibenzofuran	UG/KG		9.1 J		16 J		12.55 J		5.6 J		5.6 J
Diethyl phthalate	UG/KG		6.8 J		8.5 J		7.65 J		10 J		10 J
Dimethylphthalate	UG/KG		37.5 U		37.5 U		37.5 U		33 U		33 U
Fluoranthene	UG/KG		55 J		170		112.5 J		54 J		54 J
Fluorene	UG/KG		15 J		34 J		24.5 J		8.6 J		8.6 J
Hexachlorobenzene	UG/KG		37.5 U		37.5 U		37.5 U		33 U		33 U
Hexachlorobutadiene	UG/KG		37.5 U		37.5 U		37.5 U		33 U		33 U
Hexachlorocyclopentadiene	UG/KG		37.5 U		37.5 U		37.5 U		33 U		33 U
Hexachloroethane	UG/KG		37.5 U		37.5 U		37.5 U		33 U		33 U
Indeno(1,2,3-cd)pyrene	UG/KG		10 J		33 J		21.5 J		14 J		14 J
Isophorone	UG/KG		37.5 U		37.5 U		37.5 U		33 U		33 U
N-Nitrosodiphenylamine	UG/KG		37.5 U		37.5 U		37.5 U		33 U		33 U
N-Nitrosodipropylamine	UG/KG		37.5 U		37.5 U		37.5 U		33 U		33 U
Naphthalene	UG/KG		23 J		20 J		21.5 J		19 J		19 J
Nitrobenzene	UG/KG		37.5 U		37.5 U		37.5 U		33 U		33 U
Pentachlorophenol	UG/KG		90 U		90 U		90 U		80 U		80 U
Phenanthrene	UG/KG		63 J		180		121.5 J		43 J		43 J
Phenol	UG/KG		37.5 U		37.5 U		37.5 U		33 U		33 U
Pyrene	UG/KG		53 J		170		111.5 J		48 J		48 J
Pyridine	UG/KG										
Total Unknown PAHs as SV	MG/KG	0.3 U	0.3 U	0.3 U		0.3 U	0.3 U	3	0.7		1.85
Pesticides/PCBs											
4,4'-DDD	UG/KG				1.9 U		1.9 U		1.85 U		1.85 U
4,4'-DDE	UG/KG				1.9 U		1.9 U		1.85 U		1.85 U
4,4'-DDT	UG/KG				1.9 U		1.9 U		1.85 U		1.85 U
Aldrin	UG/KG				0.95 U		0.95 U		0.95 U		0.95 U
Alpha-BHC	UG/KG				0.95 U		0.95 U		0.95 U		0.95 U
Alpha-Chlordane	UG/KG				0.95 U		0.95 U		0.95 U		0.95 U
Beta-BHC	UG/KG				0.95 U		0.95 U		0.95 U		0.95 U
Delta-BHC	UG/KG				0.95 U		0.95 U		0.95 U		0.95 U
Dieldrin	UG/KG				1.9 U		1.9 U		1.85 U		1.85 U
Endosulfan I	UG/KG				0.95 U		0.95 U		0.95 U		0.95 U
Endosulfan II	UG/KG				1.9 U		1.9 U		1.85 U		1.85 U
Endosulfan sulfate	UG/KG				1.9 U		1.9 U		1.85 U		1.85 U
Endrin	UG/KG				1.9 U		1.9 U		1.85 U		1.85 U
Endrin aldehyde	UG/KG				1.9 U		1.9 U		1.85 U		1.85 U
Endrin ketone	UG/KG				1.9 U		1.9 U		1.85 U		1.85 U
Gamma-BHC/Lindane	UG/KG				0.95 U		0.95 U		0.95 U		0.95 U
Gamma-Chlordane	UG/KG				0.95 U		0.95 U		0.95 U		0.95 U
Heptachlor	UG/KG				0.95 U		0.95 U		0.95 U		0.95 U
Heptachlor epoxide	UG/KG				0.95 U		0.95 U		0.95 U		0.95 U
Methoxychlor	UG/KG				9.5 U		9.5 U		9.5 U		9.5 U
Toxaphene	UG/KG				95 U		95 U		95 U		95 U
Aroclor-1016	UG/KG				19 U		19 U		18.5 U		18.5 U
Aroclor-1221	UG/KG				38 U		38 U		37.5 U		37.5 U
Aroclor-1232	UG/KG				19 U		19 U		18.5 U		18.5 U
Aroclor-1242	UG/KG				19 U		19 U		18.5 U		18.5 U

Table A-1B
SEAD-59 Soil Sample-Duplicate Merged Results
SEAD-59 AND SEAD-71 PHASE II RI REPORT
Seneca Army Depot Activity

Parameter	Units	SEAD-59	SEAD-59	SEAD-59	SEAD-59	SEAD-59	SEAD-59	SEAD-59	SEAD-59	SEAD-59
		SB59-9	SB59-9	SB59-9	SB59-17	SB59-17	SB59-17	SB59-20	SB59-20	SB59-20
		SOIL	SOIL	SOIL	SOIL	SOIL	SOIL	SOIL	SOIL	SOIL
		59085	59089	59085/59089	59131	59068	59068/59131	59107	59066	59066/59107
		10/22/1997	10/22/1997	10/22/1997	10/23/1997	10/23/1997	10/23/1997	10/22/1997	10/22/1997	10/22/1997
		SA	DU	SA/DU	DU	SA	SA/DU	DU	SA	SA/DU
		Study ID	E 1 STEP 1	RI PHASE 1 STEP 1	RI PHASE 1 STEP 1	RI PHASE 1 STEP 1	RI PHASE 1 STEP 1	RI PHASE 1 STEP 1	RI PHASE 1 STEP 1	RI PHASE 1 STEP 1
		Value (Q)	Value (Q)	Value (Q)	Value (Q)	Value (Q)	Value (Q)	Value (Q)	Value (Q)	Value (Q)
Aroclor-1248	UG/KG				19 U	19 U	19 U	18.5 U	18.5 U	18.5 U
Aroclor-1254	UG/KG				19 U	19 U	19 U	18.5 U	18.5 U	18.5 U
Aroclor-1260	UG/KG				19 U	19 U	19 U	18.5 U	18.5 U	18.5 U
Metals and Cyanide										
Aluminum	MG/KG				6390	5400	5895	10700	10700	10700
Antimony	MG/KG				0.31 UJ	0.275 UJ	0.2925 UJ	0.315 UJ	0.315 UJ	0.315 UJ
Arsenic	MG/KG				3.5	2.9	3.2	3.9	3.9	3.9
Barium	MG/KG				40	35.8	37.9	88.2	88.2	88.2
Beryllium	MG/KG				0.21	0.16	0.185	0.38	0.38	0.38
Cadmium	MG/KG				0.045 U	0.04 U	0.0425 U	0.045 U	0.045 U	0.045 U
Calcium	MG/KG				88800	101000	94900	44000	44000	44000
Chromium	MG/KG				10.2	9	9.6	15.7	15.7	15.7
Cobalt	MG/KG				7.3	5.9	6.6	8.3	8.3	8.3
Copper	MG/KG				17.6	17.4	17.5	17.5	17.5	17.5
Cyanide	MG/KG				0.295 UJ	0.305 UJ	0.3 UJ	0.315 UJ	0.315 UJ	0.315 UJ
Iron	MG/KG				14800	12300	13550	19100	19100	19100
Lead	MG/KG				6.6	5.9	6.25	9.3	9.3	9.3
Magnesium	MG/KG				14800	14200	14500	9770	9770	9770
Manganese	MG/KG				391	334	362.5	407	407	407
Mercury	MG/KG				0.025 U	0.025 U	0.025 U	0.025 U	0.025 U	0.025 U
Nickel	MG/KG				19.8	17.1	18.45	23.7	23.7	23.7
Potassium	MG/KG				1230	936	1083	1440	1440	1440
Selenium	MG/KG				0.43 U	0.38 U	0.405 U	0.435 U	0.435 U	0.435 U
Silver	MG/KG				0.12 U	0.105 U	0.1125 U	0.12 U	0.12 U	0.12 U
Sodium	MG/KG				165	152	158.5	696	696	696
Thallium	MG/KG				0.44 UJ	0.385 UJ	0.4125 UJ	0.445 UJ	0.445 UJ	0.445 UJ
Vanadium	MG/KG				12.3	9.9	11.1	18.8	18.8	18.8
Zinc	MG/KG				64.7	51.1	57.9	81.7	81.7	81.7

Notes
1) Sample/Duplicate pairs were manually averaged,
Averging Procedure below
A - Non-Detects were half detection
limit, R were ignored
B - SA/DU chem values were then averaged
C - SA/DU Qualifiers were selected to
represent the discreet sample.
D - SA/DU sample ID were combined and are
marked with "SA/DU"

Table A-1C
SEAD-59 Stockpile Sample-Duplicate Merged Results
SEAD-59 AND SEAD-71 PHASE II RI REPORT
Seneca Army Depot Activity

	Facility	SEAD-59	SEAD-59	SEAD-59
	Location ID	FD-59-WS-03	WS-59-01-006-12	FD-59-WS-03/WS-59-01-006-12
	Maxtrix	SOIL	SOIL	SOIL
	Sample ID	FD-59-WS-03	WS-59-01-006-12	FD-59-WS-03/WS-59-01-006-12
	Sample Date	5/6/2004	5/6/2004	5/6/2004
	QC Code	SA	SA	SA/DU
	Study ID	ENSR IRM	ENSR IRM	ENSR IRM
Parameter	Units	Value (Q)	Value (Q)	Value (Q)
Volatile Organic Compounds				
1,1,1-Trichloroethane	UG/KG	2.85 U	2.75 U	2.8 U
1,1,2,2-Tetrachloroethane	UG/KG	2.85 UJ	2.75 UJ	2.8 UJ
1,1,2-Trichloro-1,2,2-Trifluoroethane	UG/KG	2.85 U	2.75 U	2.8 U
1,1,2-Trichloroethane	UG/KG			
1,1-Dichloroethane	UG/KG	2.85 U	2.75 U	2.8 U
1,1-Dichloroethene	UG/KG	2.85 U	2.75 U	2.8 U
1,2,3-Trichloropropane	UG/KG	2.85 UJ	2.75 UJ	2.8 UJ
1,2,4-Trichlorobenzene	UG/KG	2.85 UJ	2.75 UJ	2.8 UJ
1,2-Dibromo-3-chloropropane	UG/KG			
1,2-Dibromoethane	UG/KG			
1,2-Dichlorobenzene	UG/KG	2.85 UJ	2.75 UJ	2.8 UJ
1,2-Dichloroethane	UG/KG	2.85 U	2.75 U	2.8 U
1,2-Dichloropropane	UG/KG			
1,3-Dichlorobenzene	UG/KG	2.85 UJ	2.75 UJ	2.8 UJ
1,3-Dichloropropane	UG/KG	2.85 U	2.75 U	2.8 U
1,4-Dichlorobenzene	UG/KG	2.85 UJ	2.75 UJ	2.8 UJ
Acetone	UG/KG	11.5 U	11 U	11.25 U
Benzene	UG/KG	2.85 U	2.75 U	2.8 U
Bromodichloromethane	UG/KG			
Bromoform	UG/KG			
Carbon disulfide	UG/KG	2.85 U	2.75 U	2.8 U
Carbon tetrachloride	UG/KG	2.85 U	2.75 U	2.8 U
Chlorobenzene	UG/KG	2.85 U	2.75 U	2.8 U
Chlorodibromomethane	UG/KG	2.85 U	2.75 U	2.8 U
Chloroethane	UG/KG	5.5 U	5.5 U	5.5 U
Chloroform	UG/KG	2.85 U	2.75 U	2.8 U
Cis-1,2-Dichloroethene	UG/KG			
Cis-1,3-Dichloropropene	UG/KG			
Cyclohexane	UG/KG			
Dichlorodifluoromethane	UG/KG			
Ethyl benzene	UG/KG	2.85 U	2.75 U	2.8 U
Isopropylbenzene	UG/KG			
Meta/Para Xylene	UG/KG	2.85 U	2.75 U	2.8 U
Methyl Acetate	UG/KG			
Methyl Tertbutyl Ether	UG/KG			
Methyl bromide	UG/KG			
Methyl butyl ketone	UG/KG			
Methyl chloride	UG/KG			
Methyl cyclohexane	UG/KG			
Methyl ethyl ketone	UG/KG	5.5 U	5.5 U	5.5 U
Methyl isobutyl ketone	UG/KG	5.5 U	5.5 U	5.5 U
Methylene chloride	UG/KG	1.4 J	2.75 U	2.075 J
Ortho Xylene	UG/KG	2.85 U	2.75 U	2.8 U
Styrene	UG/KG			
Tetrachloroethene	UG/KG	2.85 U	2.75 U	2.8 U
Toluene	UG/KG	2.85 U	2.75 U	2.8 U
Total Xylenes	UG/KG			
Trans-1,2-Dichloroethene	UG/KG	2.85 U	2.75 U	2.8 U
Trans-1,3-Dichloropropene	UG/KG			
Trichloroethene	UG/KG	2.85 U	2.7 J	2.775 J
Trichlorofluoromethane	UG/KG			
Vinyl chloride	UG/KG	5.5 U	5.5 U	5.5 U
Semivolatile Organic Compounds				
1,1'-Biphenyl	UG/KG			

Table A-1C
SEAD-59 Stockpile Sample-Duplicate Merged Results
SEAD-59 AND SEAD-71 PHASE II RI REPORT
Seneca Army Depot Activity

	Facility	SEAD-59	SEAD-59	SEAD-59
	Location ID	FD-59-WS-03	WS-59-01-006-12	FD-59-WS-03/WS-59-01-006-12
	Maxtrix	SOIL	SOIL	SOIL
	Sample ID	FD-59-WS-03	WS-59-01-006-12	FD-59-WS-03/WS-59-01-006-12
	Sample Date	5/6/2004	5/6/2004	5/6/2004
	QC Code	SA	SA	SA/DU
	Study ID	ENSR IRM	ENSR IRM	ENSR IRM
Parameter	Units	Value (Q)	Value (Q)	Value (Q)
2,2'-oxybis(1-Chloropropane)	UG/KG			
2,4,5-Trichlorophenol	UG/KG	950 U	900 U	925 U
2,4,6-Trichlorophenol	UG/KG	950 U	900 U	925 U
2,4-Dichlorophenol	UG/KG	950 U	900 U	925 U
2,4-Dimethylphenol	UG/KG			
2,4-Dinitrophenol	UG/KG	4800 U	4650 U	4725 U
2,4-Dinitrotoluene	UG/KG	950 U	900 U	925 U
2,6-Dinitrotoluene	UG/KG	950 U	900 U	925 U
2-Chloronaphthalene	UG/KG			
2-Chlorophenol	UG/KG	950 U	900 U	925 U
2-Methylnaphthalene	UG/KG	950 U	900 U	925 U
2-Methylphenol	UG/KG	950 U	900 U	925 U
2-Nitroaniline	UG/KG	4800 U	4650 U	4725 U
2-Nitrophenol	UG/KG	950 U	900 U	925 U
3,3'-Dichlorobenzidine	UG/KG	950 U	900 U	925 U
3-Nitroaniline	UG/KG	4800 U	4650 U	4725 U
4,6-Dinitro-2-methylphenol	UG/KG			
4-Bromophenyl phenyl ether	UG/KG			
4-Chloro-3-methylphenol	UG/KG	950 U	900 U	925 U
4-Chloroaniline	UG/KG	950 U	900 U	925 U
4-Chlorophenyl phenyl ether	UG/KG			
4-Methylphenol	UG/KG	950 U	900 U	925 U
4-Nitroaniline	UG/KG			
4-Nitrophenol	UG/KG	4800 U	4650 U	4725 U
Acenaphthene	UG/KG	200 J	330 J	265 J
Acenaphthylene	UG/KG	1300 J	3300	2300 J
Acetophenone	UG/KG			
Aniline	UG/KG	950 U	900 U	925 U
Anthracene	UG/KG	1000 J	2400	1700 J
Atrazine	UG/KG			
Benzaldehyde	UG/KG			
Benzo(a)anthracene	UG/KG	2000	5300	3650
Benzo(a)pyrene	UG/KG	2400 J	6400 J	4400 J
Benzo(b)fluoranthene	UG/KG	1600 J	4300	2950 J
Benzo(ghi)perylene	UG/KG	1800 J	4500	3150 J
Benzo(k)fluoranthene	UG/KG	1600 J	4100	2850 J
Benzoic Acid	UG/KG	4800 UJ	4650 UJ	4725 UJ
Bis(2-Chloroethoxy)methane	UG/KG			
Bis(2-Chloroethyl)ether	UG/KG			
Bis(2-Ethylhexyl)phthalate	UG/KG	950 U	900 U	925 U
Butylbenzylphthalate	UG/KG	950 U	900 U	925 U
Caprolactam	UG/KG			
Carbazole	UG/KG			
Chrysene	UG/KG	2000	5100	3550
Di-n-butylphthalate	UG/KG	950 U	900 U	925 U
Di-n-octylphthalate	UG/KG	950 U	900 U	925 U
Dibenz(a,h)anthracene	UG/KG	560 J	1500 J	1030 J
Dibenzofuran	UG/KG	950 U	900 U	925 U
Diethyl phthalate	UG/KG	950 U	900 U	925 U
Dimethylphthalate	UG/KG	950 U	900 U	925 U
Fluoranthene	UG/KG	3600 J	9600 J	6600 J
Fluorene	UG/KG	950 U	470 J	710 J
Hexachlorobenzene	UG/KG	950 U	900 U	925 U
Hexachlorobutadiene	UG/KG	950 U	900 U	925 U
Hexachlorocyclopentadiene	UG/KG			

Table A-1C
SEAD-59 Stockpile Sample-Duplicate Merged Results
SEAD-59 AND SEAD-71 PHASE II RI REPORT
Seneca Army Depot Activity

	Facility	SEAD-59	SEAD-59	SEAD-59
	Location ID	FD-59-WS-03	WS-59-01-006-12	FD-59-WS-03/WS-59-01-006-12
	Maxtrix	SOIL	SOIL	SOIL
	Sample ID	FD-59-WS-03	WS-59-01-006-12	FD-59-WS-03/WS-59-01-006-12
	Sample Date	5/6/2004	5/6/2004	5/6/2004
	QC Code	SA	SA	SA/DU
	Study ID	ENSR IRM	ENSR IRM	ENSR IRM
Parameter	Units	Value (Q)	Value (Q)	Value (Q)
Hexachloroethane	UG/KG	950 U	900 U	925 U
Indeno(1,2,3-cd)pyrene	UG/KG	1600 J	4000 J	2800 J
Isophorone	UG/KG	950 U	900 U	925 U
N-Nitrosodiphenylamine	UG/KG			
N-Nitrosodipropylamine	UG/KG			
Naphthalene	UG/KG	950 U	900 U	925 U
Nitrobenzene	UG/KG	950 U	900 U	925 U
Pentachlorophenol	UG/KG	4800 U	4650 U	4725 U
Phenanthrene	UG/KG	1700 J	5200	3450 J
Phenol	UG/KG	950 U	900 U	925 U
Pyrene	UG/KG	3500 J	9000 J	6250 J
Pyridine	UG/KG	4800 U	4650 U	4725 U
Pesticides/PCBs				
4,4'-DDD	UG/KG	120 J	9 UJ	64.5 J
4,4'-DDE	UG/KG	260 J	9 UJ	134.5 J
4,4'-DDT	UG/KG	520 J	9 UJ	264.5 J
Aldrin	UG/KG	19 U	4.65 U	11.825 U
Alpha-BHC	UG/KG	19 U	4.65 U	11.825 U
Alpha-Chlordane	UG/KG	19 U	4.65 U	11.825 U
Beta-BHC	UG/KG	19 U	4.65 U	11.825 U
Delta-BHC	UG/KG	19 U	4.65 U	11.825 U
Dieldrin	UG/KG	37.5 U	9 U	23.25 U
Endosulfan I	UG/KG	19 U	4.65 U	11.825 U
Endosulfan II	UG/KG	37.5 U	9 U	23.25 U
Endosulfan sulfate	UG/KG	37.5 U	9 U	23.25 U
Endrin	UG/KG	37.5 U	9 U	23.25 U
Endrin aldehyde	UG/KG	37.5 U	9 U	23.25 U
Endrin ketone	UG/KG	37.5 U	9 U	23.25 U
Gamma-BHC/Lindane	UG/KG	19 U	4.65 U	11.825 U
Gamma-Chlordane	UG/KG	19 U	4.65 U	11.825 U
Heptachlor	UG/KG	19 U	4.65 U	11.825 U
Heptachlor epoxide	UG/KG	19 U	4.65 U	11.825 U
Methoxychlor	UG/KG	190 U	46.5 U	118.25 U
Toxaphene	UG/KG	375 U	90 U	232.5 U
Aroclor-1016	UG/KG	18.5 U	18 U	18.25 U
Aroclor-1221	UG/KG	18.5 U	18 U	18.25 U
Aroclor-1232	UG/KG	18.5 U	18 U	18.25 U
Aroclor-1242	UG/KG	18.5 U	18 U	18.25 U
Aroclor-1248	UG/KG	18.5 U	18 U	18.25 U
Aroclor-1254	UG/KG	18.5 U	18 U	18.25 U
Aroclor-1260	UG/KG	18.5 U	18 U	18.25 U
Metals				
Aluminum	MG/KG	9910	10700	10305
Antimony	MG/KG	1.7 UJ	1.6 UJ	1.65 UJ
Arsenic	MG/KG	5.8 J	4.8 J	5.3 J
Barium	MG/KG	85.1	80.1	82.6
Beryllium	MG/KG	0.27	0.27	0.27
Cadmium	MG/KG	0.61	0.66	0.635
Calcium	MG/KG	52900	59000	55950
Chromium	MG/KG	17	18.8	17.9
Cobalt	MG/KG	10.2	10.4	10.3
Copper	MG/KG	28.2 J	29.1 J	28.65 J
Iron	MG/KG	18100	19600	18850
Lead	MG/KG	50.9	69.1	60
Magnesium	MG/KG	9070	8020	8545

Table A-1C
SEAD-59 Stockpile Sample-Duplicate Merged Results
SEAD-59 AND SEAD-71 PHASE II RI REPORT
Seneca Army Depot Activity

	Facility	SEAD-59	SEAD-59	SEAD-59
	Location ID	FD-59-WS-03	WS-59-01-006-12	FD-59-WS-03/WS-59-01-006-12
	Maxtrix	SOIL	SOIL	SOIL
	Sample ID	FD-59-WS-03	WS-59-01-006-12	FD-59-WS-03/WS-59-01-006-12
	Sample Date	5/6/2004	5/6/2004	5/6/2004
	QC Code	SA	SA	SA/DU
	Study ID	ENSR IRM	ENSR IRM	ENSR IRM
Parameter	Units	Value (Q)	Value (Q)	Value (Q)
Manganese	MG/KG	461	529	495
Mercury	MG/KG	0.06	0.04	0.05
Nickel	MG/KG	26.9	30	28.45
Potassium	MG/KG	1060	1050	1055
Selenium	MG/KG	0.285 U	0.265 U	0.275 U
Silver	MG/KG	0.285 UJ	0.265 UJ	0.275 UJ
Sodium	MG/KG	178	148	163
Thallium	MG/KG	0.285 U	0.265 U	0.275 U
Vanadium	MG/KG	18.6	18.3	18.45
Zinc	MG/KG	135 J	87.2 J	111.1 J

Notes

- 1) Sample/Duplicate pairs were manually averaged.
 Averging Procedure below
- A - Non-Detects were half detection limit, R were ignored
- B - SA/DU chem values were then averaged
- C - SA/DU Qualifiers were selected to represent the discreet sample.
- D - SA/DU sample ID were combined and are marked with "SA/DU"

Table A-1D
SEAD-59 Groundwater Sample-Duplicate Merged Results
SEAD-59 AND SEAD-71 PHASE II RI REPORT
Seneca Army Depot Activity

	Facility	SEAD-59	SEAD-59	SEAD-59
	Location ID	MW59-3	MW59-3	MW59-3
	Maxtrix	GROUNDWATER	GROUNDWATER	GROUNDWATER
	Sample ID	592007	592010	592007/592010
	Sample Date	8/30/2004	8/30/2004	8/30/2004
	QC Code	SA	SA	SA/DU
	Study ID	RI 2004	RI 2004	RI 2004
Parameter	Units	Value (Q)	Value (Q)	Value (Q)
Volatile Organic Compounds				
1,1,1,2-Tetrachloroethane	UG/KG	0.5 U	0.5 U	0.5 U
1,1,1-Trichloroethane	UG/KG	0.44 J	0.46 J	0.45 J
1,1,2,2-Tetrachloroethane	UG/KG	0.5 U	0.5 U	0.5 U
1,1,2-Trichloroethane	UG/KG	0.5 U	0.5 U	0.5 U
1,1-Dichloroethane	UG/KG	0.5 U	0.5 U	0.5 U
1,1-Dichloroethene	UG/KG	0.5 U	0.5 U	0.5 U
1,1-Dichloropropene	UG/KG	0.5 U	0.5 U	0.5 U
1,2,3-Trichlorobenzene	UG/KG	0.5 U	0.5 U	0.5 U
1,2,3-Trichloropropane	UG/KG	0.5 U	0.5 U	0.5 U
1,2,4-Trichlorobenzene	UG/KG	0.5 U	0.5 U	0.5 U
1,2,4-Trimethylbenzene	UG/KG	0.5 U	0.5 U	0.5 U
1,2-Dibromo-3-chloropropane	UG/KG	0.5 U	0.5 U	0.5 U
1,2-Dibromoethane	UG/KG	0.5 U	0.5 U	0.5 U
1,2-Dichlorobenzene	UG/KG	0.5 U	0.5 U	0.5 U
1,2-Dichloroethane	UG/KG	0.5 U	0.5 U	0.5 U
1,2-Dichloroethene (total)	UG/KG			
1,2-Dichloropropane	UG/KG	0.5 U	0.5 U	0.5 U
1,3,5-Trimethylbenzene	UG/KG	0.5 U	0.5 U	0.5 U
1,3-Dichlorobenzene	UG/KG	0.5 U	0.5 U	0.5 U
1,3-Dichloropropane	UG/KG	0.5 U	0.5 U	0.5 U
1,4-Dichlorobenzene	UG/KG	0.5 U	0.5 U	0.5 U
2,2-Dichloropropane	UG/KG	0.5 U	0.5 U	0.5 U
2-Chlorotoluene	UG/KG	0.5 U	0.5 U	0.5 U
Acetone	UG/KG			
Benzene	UG/KG	0.5 U	0.5 U	0.5 U
Bromobenzene	UG/KG	0.5 U	0.5 U	0.5 U
Bromochloromethane	UG/KG	0.5 U	0.5 U	0.5 U
Bromodichloromethane	UG/KG	0.5 U	0.5 U	0.5 U
Bromoform	UG/KG	0.5 U	0.5 U	0.5 U
Carbon disulfide	UG/KG			
Carbon tetrachloride	UG/KG	0.5 U	0.5 U	0.5 U
Chlorobenzene	UG/KG	0.5 U	0.5 U	0.5 U
Chlorodibromomethane	UG/KG	0.5 U	0.5 U	0.5 U
Chloroethane	UG/KG	0.5 U	0.5 U	0.5 U
Chloroform	UG/KG	0.5 U	0.5 U	0.5 U
Cis-1,2-Dichloroethene	UG/KG	0.5 U	0.5 U	0.5 U
Cis-1,3-Dichloropropene	UG/KG	0.5 U	0.5 U	0.5 U
Dichlorodifluoromethane	UG/KG	0.5 U	0.5 U	0.5 U
Ethyl benzene	UG/KG	0.5 U	0.5 U	0.5 U
Hexachlorobutadiene	UG/KG	0.5 U	0.5 U	0.5 U
Isopropylbenzene	UG/KG	0.5 U	0.5 U	0.5 U
Meta/Para Xylene	UG/KG	0.5 U	0.5 U	0.5 U
Methyl bromide	UG/KG	0.5 U	0.5 U	0.5 U
Methyl butyl ketone	UG/KG			
Methyl chloride	UG/KG	0.5 U	0.5 U	0.5 U
Methyl ethyl ketone	UG/KG			

Table A-1D
SEAD-59 Groundwater Sample-Duplicate Merged Results
SEAD-59 AND SEAD-71 PHASE II RI REPORT
Seneca Army Depot Activity

	Facility	SEAD-59	SEAD-59	SEAD-59
	Location ID	MW59-3	MW59-3	MW59-3
	Maxtrix	GROUNDWATER	GROUNDWATER	GROUNDWATER
	Sample ID	592007	592010	592007/592010
	Sample Date	8/30/2004	8/30/2004	8/30/2004
	QC Code	SA	SA	SA/DU
	Study ID	RI 2004	RI 2004	RI 2004
Parameter	Units	Value (Q)	Value (Q)	Value (Q)
Methyl isobutyl ketone	UG/KG			
Methylene bromide	UG/KG	0.5 U	0.5 U	0.5 U
Methylene chloride	UG/KG	0.5 U	0.5 U	0.5 U
Naphthalene	UG/KG	0.5 U	0.5 U	0.5 U
Ortho Xylene	UG/KG	0.5 U	0.5 U	0.5 U
Propylbenzene	UG/KG	0.5 U	0.5 U	0.5 U
Styrene	UG/KG	0.5 U	0.5 U	0.5 U
Tetrachloroethene	UG/KG	0.5 U	0.5 U	0.5 U
Toluene	UG/KG	0.5 U	0.5 U	0.5 U
Total Xylenes	UG/KG	0.5 U	0.5 U	0.5 U
Trans-1,2-Dichloroethene	UG/KG	0.5 U	0.5 U	0.5 U
Trans-1,3-Dichloropropene	UG/KG	0.5 U	0.5 U	0.5 U
Trichloroethene	UG/KG	0.5 U	0.5 U	0.5 U
Trichlorofluoromethane	UG/KG	0.5 U	0.5 U	0.5 U
Vinyl acetate	UG/KG	1 U	1 U	1 U
Vinyl chloride	UG/KG	0.5 U	0.5 U	0.5 U
n-Butylbenzene	UG/KG	0.5 U	0.5 U	0.5 U
p-Chlorotoluene	UG/KG	0.5 U	0.5 U	0.5 U
p-Isopropyltoluene	UG/KG	0.5 U	0.5 U	0.5 U
sec-Butylbenzene	UG/KG	0.5 U	0.5 U	0.5 U
tert-Butylbenzene	UG/KG	0.5 U	0.5 U	0.5 U
Semivolatile Organic Compounds				
1,2,4-Trichlorobenzene	UG/KG	9.7 U	10 U	9.85 U
1,2-Dichlorobenzene	UG/KG	9.7 U	10 U	9.85 U
1,2-Diphenylhydrazine	UG/KG	9.7 UJ	10 UJ	9.85 UJ
1,3-Dichlorobenzene	UG/KG	9.7 U	10 U	9.85 U
1,4-Dichlorobenzene	UG/KG	9.7 U	10 U	9.85 U
2,2'-oxybis(1-Chloropropane)	UG/KG			
2,4,5-Trichlorophenol	UG/KG	9.7 U	10 U	9.85 U
2,4,6-Trichlorophenol	UG/KG	9.7 U	10 U	9.85 U
2,4-Dichlorophenol	UG/KG	9.7 U	10 U	9.85 U
2,4-Dimethylphenol	UG/KG	9.7 U	10 U	9.85 U
2,4-Dinitrophenol	UG/KG	19.4 U	20 U	19.7 U
2,4-Dinitrotoluene	UG/KG	9.7 U	10 U	9.85 U
2,6-Dichlorophenol	UG/KG	9.7 U	10 U	9.85 U
2,6-Dinitrotoluene	UG/KG	9.7 U	10 U	9.85 U
2-Chloronaphthalene	UG/KG	0.97 U	1 U	0.985 U
2-Chlorophenol	UG/KG	9.7 U	10 U	9.85 U
2-Methylnaphthalene	UG/KG	0.97 U	1 U	0.985 U
2-Methylphenol	UG/KG	9.7 U	10 U	9.85 U
2-Nitroaniline	UG/KG	9.7 U	10 U	9.85 U
2-Nitrophenol	UG/KG	9.7 U	10 U	9.85 U
3,3'-Dichlorobenzidine	UG/KG	9.7 U	10 U	9.85 U
3-Nitroaniline	UG/KG	9.7 U	10 U	9.85 U
4,6-Dinitro-2-methylphenol	UG/KG	9.7 U	10 U	9.85 U
4-Bromophenyl phenyl ether	UG/KG	9.7 U	10 U	9.85 U
4-Chloro-3-methylphenol	UG/KG	9.7 U	10 U	9.85 U

Table A-1D
SEAD-59 Groundwater Sample-Duplicate Merged Results
SEAD-59 AND SEAD-71 PHASE II RI REPORT
Seneca Army Depot Activity

	Facility	SEAD-59	SEAD-59	SEAD-59
	Location ID	MW59-3	MW59-3	MW59-3
	Maxtrix	GROUNDWATER	GROUNDWATER	GROUNDWATER
	Sample ID	592007	592010	592007/592010
	Sample Date	8/30/2004	8/30/2004	8/30/2004
	QC Code	SA	SA	SA/DU
	Study ID	RI 2004	RI 2004	RI 2004
Parameter	Units	Value (Q)	Value (Q)	Value (Q)
4-Chloroaniline	UG/KG	9.7 U	10 U	9.85 U
4-Chlorophenyl phenyl ether	UG/KG	9.7 U	10 U	9.85 U
4-Methylphenol	UG/KG	9.7 U	10 U	9.85 U
4-Nitroaniline	UG/KG	9.7 U	10 U	9.85 U
4-Nitrophenol	UG/KG	9.7 U	10 U	9.85 U
Acenaphthene	UG/KG	0.97 U	1 U	0.985 U
Acenaphthylene	UG/KG	0.97 U	1 U	0.985 U
Acetophenone	UG/KG	9.7 U	10 U	9.85 U
Anthracene	UG/KG	0.97 U	1 U	0.985 U
Benzidine	UG/KG	48.5 U	50 U	49.25 U
Benzo(a)anthracene	UG/KG	0.97 U	1 U	0.985 U
Benzo(a)pyrene	UG/KG	0.97 U	1 U	0.985 U
Benzo(b)fluoranthene	UG/KG	0.97 UJ	1 UJ	0.985 UJ
Benzo(ghi)perylene	UG/KG	0.97 U	1 U	0.985 U
Benzo(k)fluoranthene	UG/KG	0.97 U	1 U	0.985 U
Benzoic Acid	UG/KG	19.4 UJ	20 UJ	19.7 UJ
Benzyl alcohol	UG/KG	9.7 U	10 U	9.85 U
Bis(2-Chloroethoxy)methane	UG/KG	9.7 U	10 U	9.85 U
Bis(2-Chloroethyl)ether	UG/KG	9.7 U	10 U	9.85 U
Bis(2-Chloroisopropyl)ether	UG/KG	9.7 UJ	10 UJ	9.85 UJ
Bis(2-Ethylhexyl)phthalate	UG/KG	9.7 U	10 U	9.85 U
Butylbenzylphthalate	UG/KG	9.7 U	10 U	9.85 U
Carbazole	UG/KG	9.7 U	10 U	9.85 U
Chrysene	UG/KG	0.97 U	1 U	0.985 U
Di-n-butylphthalate	UG/KG	9.7 U	10 U	9.85 U
Di-n-octylphthalate	UG/KG	9.7 U	10 U	9.85 U
Dibenz(a,h)anthracene	UG/KG	0.97 U	1 U	0.985 U
Dibenzofuran	UG/KG	9.7 U	10 U	9.85 U
Diethyl phthalate	UG/KG	9.7 U	10 U	9.85 U
Dimethylphthalate	UG/KG	9.7 U	10 U	9.85 U
Diphenylamine	UG/KG	9.7 U	10 U	9.85 U
Fluoranthene	UG/KG	0.97 U	1 U	0.985 U
Fluorene	UG/KG	0.97 U	1 U	0.985 U
Hexachlorobenzene	UG/KG	9.7 U	10 U	9.85 U
Hexachlorobutadiene	UG/KG	9.7 U	10 U	9.85 U
Hexachlorocyclopentadiene	UG/KG			
Hexachloroethane	UG/KG	9.7 U	10 U	9.85 U
Indeno(1,2,3-cd)pyrene	UG/KG	0.97 U	1 U	0.985 U
Isophorone	UG/KG	9.7 U	10 U	9.85 U
N-Nitrosodimethylamine	UG/KG	9.7 U	10 U	9.85 U
N-Nitrosodiphenylamine	UG/KG			
N-Nitrosodipropylamine	UG/KG	9.7 U	10 U	9.85 U
N-Nitrosopyrrolidine	UG/KG	9.7 U	10 U	9.85 U
Naphthalene	UG/KG	0.97 U	1 U	0.985 U
Nitrobenzene	UG/KG	9.7 U	10 U	9.85 U
Pentachlorophenol	UG/KG	9.7 U	10 U	9.85 U
Phenanthrene	UG/KG	0.97 U	1 U	0.985 U

Table A-1D
SEAD-59 Groundwater Sample-Duplicate Merged Results
SEAD-59 AND SEAD-71 PHASE II RI REPORT
Seneca Army Depot Activity

	Facility	SEAD-59	SEAD-59	SEAD-59
	Location ID	MW59-3	MW59-3	MW59-3
	Maxtrix	GROUNDWATER	GROUNDWATER	GROUNDWATER
	Sample ID	592007	592010	592007/592010
	Sample Date	8/30/2004	8/30/2004	8/30/2004
	QC Code	SA	SA	SA/DU
	Study ID	RI 2004	RI 2004	RI 2004
Parameter	Units	Value (Q)	Value (Q)	Value (Q)
Phenol	UG/KG	9.7 U	10 U	9.85 U
Pyrene	UG/KG	0.97 U	1 U	0.985 U
Pesticides/PCBs				
4,4'-DDD	UG/KG	0.0381 U	0.04 U	0.03905 U
4,4'-DDE	UG/KG	0.0381 U	0.04 U	0.03905 U
4,4'-DDT	UG/KG	0.0381 U	0.04 U	0.03905 U
Aldrin	UG/KG	0.019 U	0.02 U	0.0195 U
Alpha-BHC	UG/KG	0.019 U	0.02 U	0.0195 U
Beta-BHC	UG/KG	0.019 U	0.02 U	0.0195 U
Chlordane	UG/KG	0.238 UJ	0.25 UJ	0.244 UJ
Delta-BHC	UG/KG	0.019 UJ	0.02 UJ	0.0195 UJ
Dieldrin	UG/KG	0.0381 U	0.04 U	0.03905 U
Endosulfan I	UG/KG	0.019 U	0.02 U	0.0195 U
Endosulfan II	UG/KG	0.0381 U	0.04 U	0.03905 U
Endosulfan sulfate	UG/KG	0.0381 U	0.04 U	0.03905 U
Endrin	UG/KG	0.0381 U	0.04 U	0.03905 U
Endrin aldehyde	UG/KG	0.0381 U	0.04 U	0.03905 U
Endrin ketone	UG/KG	0.0381 U	0.04 U	0.03905 U
Gamma-BHC/Lindane	UG/KG	0.019 U	0.02 U	0.0195 U
Heptachlor	UG/KG	0.019 U	0.02 U	0.0195 U
Heptachlor epoxide	UG/KG	0.019 U	0.02 U	0.0195 U
Methoxychlor	UG/KG	0.19 U	0.2 U	0.195 U
Toxaphene	UG/KG	0.952 U	1 U	0.976 U
Aroclor-1016	UG/KG	0.476 U	0.5 U	0.488 U
Aroclor-1221	UG/KG	0.476 U	0.5 U	0.488 U
Aroclor-1232	UG/KG	0.476 U	0.5 U	0.488 U
Aroclor-1242	UG/KG	0.476 U	0.5 U	0.488 U
Aroclor-1248	UG/KG	0.476 U	0.5 U	0.488 U
Aroclor-1254	UG/KG	0.476 U	0.5 U	0.488 U
Aroclor-1260	UG/KG	0.476 U	0.5 U	0.488 U
Metals and Cyanide				
Aluminum	MG/KG	336 J	103 J	219.5 J
Antimony	MG/KG	10 U	10 U	10 U
Arsenic	MG/KG	5 U	5 U	5 U
Barium	MG/KG	80.3	80.7	80.5
Beryllium	MG/KG	5 U	5 U	5 U
Cadmium	MG/KG	0.91 J	0.89 J	0.9 J
Calcium	MG/KG	102000	103000	102500
Chromium	MG/KG	5 U	1.2 J	3.1 J
Cobalt	MG/KG	5 U	5 U	5 U
Copper	MG/KG	1.9 J	5 U	3.45 J
Cyanide	MG/KG			
Iron	MG/KG	385	146	265.5
Lead	MG/KG	5 U	5 U	5 U
Magnesium	MG/KG	12700	12900	12800
Manganese	MG/KG	46.3 J	20.9 J	33.6 J
Mercury	MG/KG	0.2 U	0.2 U	0.2 U

Table A-1D
SEAD-59 Groundwater Sample-Duplicate Merged Results
SEAD-59 AND SEAD-71 PHASE II RI REPORT
Seneca Army Depot Activity

	Facility	SEAD-59	SEAD-59	SEAD-59
	Location ID	MW59-3	MW59-3	MW59-3
	Maxtrix	GROUNDWATER	GROUNDWATER	GROUNDWATER
	Sample ID	592007	592010	592007/592010
	Sample Date	8/30/2004	8/30/2004	8/30/2004
	QC Code	SA	SA	SA/DU
	Study ID	RI 2004	RI 2004	RI 2004
Parameter	Units	Value (Q)	Value (Q)	Value (Q)
Nickel	MG/KG	1.5 J	2 J	1.75 J
Potassium	MG/KG	1710	1630	1670
Selenium	MG/KG	5 R	5 R	5 R
Silver	MG/KG	5 U	5 U	5 U
Sodium	MG/KG	233000	236000	234500
Thallium	MG/KG	20 U	20 U	20 U
Vanadium	MG/KG	5 U	0.89 J	2.945 J
Zinc	MG/KG	9.9	5.6	7.75

Notes:

Averging Procedure below

A - SA/DU chem values were then averaged

B - SA/DU Qualifiers were selected to represent the discreet sample.

C - SA/DU sample ID were combined and are marked with "SA/DU"

Table A-1E
SEAD-71 Groundwater Sample-Duplicate Merged Results
SEAD-59 AND SEAD-71 PHASE II RI REPORT
Seneca Army Depot Activity

	Facility	SEAD-71	SEAD-71	SEAD-71
	Location ID	MW71-4	MW71-4	MW71-4
	Maxtrix	GROUNDWATER	GROUNDWATER	GROUNDWATER
	Sample ID	712003	712002	712003/712002
	Sample Depth to Top of Sample	20.67	20.67	20.67
	Sample Depth to Bottom of Sample	20.67	20.67	20.67
	Sample Date	4/5/2004	4/5/2004	4/5/2004
	QC Code	SA	SA	SA/DU
	Study ID	RI 2004	RI 2004	RI 2004
		1	1	1
Parameter	Units	Value (Q)	Value (Q)	Value (Q)
Volatile Organic Compounds				
1,1,1,2-Tetrachloroethane	UG/L	0.5 U	0.5 U	0.5 U
1,1,1-Trichloroethane	UG/L	3.1	3.1	3.1
1,1,2,2-Tetrachloroethane	UG/L	0.5 U	0.5 U	0.5 U
1,1,2-Trichloroethane	UG/L	0.5 U	0.5 U	0.5 U
1,1-Dichloroethane	UG/L	0.5 U	0.5 U	0.5 U
1,1-Dichloroethene	UG/L	0.5 U	0.5 U	0.5 U
1,1-Dichloropropene	UG/L	0.5 U	0.5 U	0.5 U
1,2,3-Trichlorobenzene	UG/L	0.5 U	0.5 U	0.5 U
1,2,3-Trichloropropane	UG/L	0.5 U	0.5 U	0.5 U
1,2,4-Trichlorobenzene	UG/L	0.5 U	0.5 U	0.5 U
1,2,4-Trimethylbenzene	UG/L	0.5 U	0.5 U	0.5 U
1,2-Dibromo-3-chloropropane	UG/L	0.5 U	0.5 U	0.5 U
1,2-Dibromoethane	UG/L	0.5 U	0.5 U	0.5 U
1,2-Dichlorobenzene	UG/L	0.5 U	0.5 U	0.5 U
1,2-Dichloroethane	UG/L	0.5 U	0.5 U	0.5 U
1,2-Dichloropropane	UG/L	0.5 U	0.5 U	0.5 U
1,3,5-Trimethylbenzene	UG/L	0.5 U	0.5 U	0.5 U
1,3-Dichlorobenzene	UG/L	0.5 U	0.5 U	0.5 U
1,3-Dichloropropane	UG/L	0.5 U	0.5 U	0.5 U
1,4-Dichlorobenzene	UG/L	0.5 U	0.5 U	0.5 U
2,2-Dichloropropane	UG/L	0.5 U	0.5 U	0.5 U
2-Chlorotoluene	UG/L	0.5 U	0.5 U	0.5 U
Benzene	UG/L	0.5 U	0.5 U	0.5 U
Bromobenzene	UG/L	0.5 U	0.5 U	0.5 U
Bromochloromethane	UG/L	0.5 U	0.5 U	0.5 U
Bromodichloromethane	UG/L	0.5 U	0.5 U	0.5 U
Bromoform	UG/L	0.5 U	0.5 U	0.5 U
Carbon tetrachloride	UG/L	0.5 U	0.5 U	0.5 U
Chlorobenzene	UG/L	0.5 U	0.5 U	0.5 U
Chlorodibromomethane	UG/L	0.5 U	0.5 U	0.5 U
Chloroethane	UG/L	0.5 U	0.5 U	0.5 U
Chloroform	UG/L	0.5 U	0.5 U	0.5 U
Cis-1,2-Dichloroethene	UG/L	0.5 U	0.5 U	0.5 U
Cis-1,3-Dichloropropene	UG/L	0.5 U	0.5 U	0.5 U
Dichlorodifluoromethane	UG/L	0.5 U	0.5 U	0.5 U
Ethyl benzene	UG/L	0.5 U	0.5 U	0.5 U
Hexachlorobutadiene	UG/L	0.5 U	0.5 U	0.5 U
Isopropylbenzene	UG/L	0.5 U	0.5 U	0.5 U
Meta/Para Xylene	UG/L	0.5 U	0.5 U	0.5 U
Methyl bromide	UG/L	0.5 U	0.5 U	0.5 U
Methyl chloride	UG/L	0.5 U	0.5 U	0.5 U
Methylene bromide	UG/L	0.5 U	0.5 U	0.5 U
Methylene chloride	UG/L	0.5 U	0.5 U	0.5 U
Naphthalene	UG/L	0.5 U	0.5 U	0.5 U
Ortho Xylene	UG/L	0.5 U	0.5 U	0.5 U
Propylbenzene	UG/L	0.5 U	0.5 U	0.5 U
Styrene	UG/L	0.5 U	0.5 U	0.5 U
Tetrachloroethene	UG/L	0.5 U	0.5 U	0.5 U

Table A-1E
SEAD-71 Groundwater Sample-Duplicate Merged Results
SEAD-59 AND SEAD-71 PHASE II RI REPORT
Seneca Army Depot Activity

	Facility	SEAD-71	SEAD-71	SEAD-71
	Location ID	MW71-4	MW71-4	MW71-4
	Maxtrix	GROUNDWATER	GROUNDWATER	GROUNDWATER
	Sample ID	712003	712002	712003/712002
	Sample Depth to Top of Sample	20.67	20.67	20.67
	Sample Depth to Bottom of Sample	20.67	20.67	20.67
	Sample Date	4/5/2004	4/5/2004	4/5/2004
	QC Code	SA	SA	SA/DU
	Study ID	RI 2004	RI 2004	RI 2004
		1	1	1
Parameter	Units	Value (Q)	Value (Q)	Value (Q)
Toluene	UG/L	0.5 U	0.5 U	0.5 U
Total Xylenes	UG/L	0.5 U	0.5 U	0.5 U
Trans-1,2-Dichloroethene	UG/L	0.5 U	0.5 U	0.5 U
Trans-1,3-Dichloropropene	UG/L	0.5 U	0.5 U	0.5 U
Trichloroethene	UG/L	0.5 U	0.5 U	0.5 U
Trichlorofluoromethane	UG/L	0.5 U	0.5 U	0.5 U
Vinyl acetate	UG/L	1 U	1 U	1 U
Vinyl chloride	UG/L	0.5 U	0.5 U	0.5 U
n-Butylbenzene	UG/L	0.5 U	0.5 U	0.5 U
p-Chlorotoluene	UG/L	0.5 U	0.5 U	0.5 U
p-Isopropyltoluene	UG/L	0.5 U	0.5 U	0.5 U
sec-Butylbenzene	UG/L	0.5 U	0.5 U	0.5 U
tert-Butylbenzene	UG/L	0.5 U	0.5 U	0.5 U
Semivolatile Organic Compounds				
1,2,4-Trichlorobenzene	UG/L	9.8 U	9.8 U	9.8 U
1,2-Dichlorobenzene	UG/L	9.8 U	9.8 U	9.8 U
1,2-Diphenylhydrazine	UG/L	9.8 U	9.8 U	9.8 U
1,3-Dichlorobenzene	UG/L	9.8 U	9.8 U	9.8 U
1,4-Dichlorobenzene	UG/L	9.8 U	9.8 U	9.8 U
2,4,5-Trichlorophenol	UG/L	9.8 U	9.8 U	9.8 U
2,4,6-Trichlorophenol	UG/L	9.8 U	9.8 U	9.8 U
2,4-Dichlorophenol	UG/L	9.8 U	9.8 U	9.8 U
2,4-Dimethylphenol	UG/L	9.8 U	9.8 U	9.8 U
2,4-Dinitrophenol	UG/L	19.6 U	19.6 U	19.6 U
2,4-Dinitrotoluene	UG/L	9.8 U	9.8 U	9.8 U
2,6-Dichlorophenol	UG/L	9.8 U	9.8 U	9.8 U
2,6-Dinitrotoluene	UG/L	9.8 U	9.8 U	9.8 U
2-Chloronaphthalene	UG/L	0.98 U	0.98 U	0.98 U
2-Chlorophenol	UG/L	9.8 U	9.8 U	9.8 U
2-Methylnaphthalene	UG/L	0.98 U	0.98 U	0.98 U
2-Methylphenol	UG/L	9.8 U	9.8 U	9.8 U
2-Nitroaniline	UG/L	9.8 U	9.8 U	9.8 U
2-Nitrophenol	UG/L	9.8 U	9.8 U	9.8 U
3,3'-Dichlorobenzidine	UG/L	9.8 UJ	9.8 UJ	9.8 UJ
3-Nitroaniline	UG/L	9.8 U	9.8 U	9.8 U
4,6-Dinitro-2-methylphenol	UG/L	9.8 U	9.8 U	9.8 U
4-Bromophenyl phenyl ether	UG/L	9.8 U	9.8 U	9.8 U
4-Chloro-3-methylphenol	UG/L	9.8 U	9.8 U	9.8 U
4-Chloroaniline	UG/L	9.8 U	9.8 U	9.8 U
4-Chlorophenyl phenyl ether	UG/L	9.8 U	9.8 U	9.8 U
4-Methylphenol	UG/L	9.8 U	9.8 U	9.8 U
4-Nitroaniline	UG/L	9.8 U	9.8 U	9.8 U
4-Nitrophenol	UG/L	9.8 U	9.8 U	9.8 U
Acenaphthene	UG/L	0.98 U	0.98 U	0.98 U
Acenaphthylene	UG/L	0.98 U	0.98 U	0.98 U
Acetophenone	UG/L	9.8 U	9.8 U	9.8 U
Anthracene	UG/L	0.98 U	0.98 U	0.98 U
Benzdine	UG/L	49 U	49 U	49 U
Benzo(a)anthracene	UG/L	0.98 U	0.98 U	0.98 U

Table A-1E
SEAD-71 Groundwater Sample-Duplicate Merged Results
SEAD-59 AND SEAD-71 PHASE II RI REPORT
Seneca Army Depot Activity

	Facility	SEAD-71	SEAD-71	SEAD-71
	Location ID	MW71-4	MW71-4	MW71-4
	Maxtrix	GROUNDWATER	GROUNDWATER	GROUNDWATER
	Sample ID	712003	712002	712003/712002
	Sample Depth to Top of Sample	20.67	20.67	20.67
	Sample Depth to Bottom of Sample	20.67	20.67	20.67
	Sample Date	4/5/2004	4/5/2004	4/5/2004
	QC Code	SA	SA	SA/DU
	Study ID	RI 2004	RI 2004	RI 2004
		1	1	1
Parameter	Units	Value (Q)	Value (Q)	Value (Q)
Benzo(a)pyrene	UG/L	0.98 U	0.98 U	0.98 U
Benzo(b)fluoranthene	UG/L	0.98 U	0.98 U	0.98 U
Benzo(ghi)perylene	UG/L	0.98 U	0.98 U	0.98 U
Benzo(k)fluoranthene	UG/L	0.98 U	0.98 U	0.98 U
Benzoic Acid	UG/L	19.6 U	19.6 U	19.6 U
Benzyl alcohol	UG/L	9.8 U	9.8 U	9.8 U
Bis(2-Chloroethoxy)methane	UG/L	9.8 U	9.8 U	9.8 U
Bis(2-Chloroethyl)ether	UG/L	9.8 U	9.8 U	9.8 U
Bis(2-Chloroisopropyl)ether	UG/L	9.8 U	9.8 U	9.8 U
Bis(2-Ethylhexyl)phthalate	UG/L	9.8 U	9.8 U	9.8 U
Butylbenzylphthalate	UG/L	9.8 U	9.8 U	9.8 U
Carbazole	UG/L	9.8 U	9.8 U	9.8 U
Chrysene	UG/L	0.98 U	0.98 U	0.98 U
Di-n-butylphthalate	UG/L	9.8 U	9.8 U	9.8 U
Di-n-octylphthalate	UG/L	9.8 U	9.8 U	9.8 U
Dibenz(a,h)anthracene	UG/L	0.98 U	0.98 U	0.98 U
Dibenzofuran	UG/L	9.8 U	9.8 U	9.8 U
Diethyl phthalate	UG/L	9.8 U	9.8 U	9.8 U
Dimethylphthalate	UG/L	9.8 U	9.8 U	9.8 U
Diphenylamine	UG/L	9.8 U	9.8 U	9.8 U
Fluoranthene	UG/L	0.98 U	0.98 U	0.98 U
Fluorene	UG/L	0.98 U	0.98 U	0.98 U
Hexachlorobenzene	UG/L	9.8 U	9.8 U	9.8 U
Hexachlorobutadiene	UG/L	9.8 U	9.8 U	9.8 U
Hexachloroethane	UG/L	9.8 U	9.8 U	9.8 U
Indeno(1,2,3-cd)pyrene	UG/L	0.98 U	0.98 U	0.98 U
Isophorone	UG/L	9.8 U	9.8 U	9.8 U
N-Nitrosodimethylamine	UG/L	9.8 U	9.8 U	9.8 U
N-Nitrosodipropylamine	UG/L	9.8 U	9.8 U	9.8 U
N-Nitrosopyrrolidine	UG/L	9.8 U	9.8 U	9.8 U
Naphthalene	UG/L	0.98 U	0.98 U	0.98 U
Nitrobenzene	UG/L	9.8 U	9.8 U	9.8 U
Pentachlorophenol	UG/L	9.8 U	9.8 U	9.8 U
Phenanthrene	UG/L	0.98 U	0.98 U	0.98 U
Phenol	UG/L	9.8 U	9.8 U	9.8 U
Pyrene	UG/L	0.98 U	0.98 U	0.98 U
Pesticides/PCBs				
4,4'-DDD	UG/L	0.0385 U	0.0364 UJ	0.03745 UJ
4,4'-DDE	UG/L	0.0385 U	0.006 J	0.02225 J
4,4'-DDT	UG/L	0.0385 UJ	0.04 J	0.03925 J
Aldrin	UG/L	0.0192 U	0.0182 UJ	0.0187 UJ
Alpha-BHC	UG/L	0.0192 U	0.0182 UJ	0.0187 UJ
Beta-BHC	UG/L	0.0192 U	0.0182 UJ	0.0187 UJ
Chlordane	UG/L	0.24 U	0.227 UJ	0.2335 UJ
Delta-BHC	UG/L	0.0192 U	0.0182 UJ	0.0187 UJ
Dieldrin	UG/L	0.0385 U	0.0364 UJ	0.03745 UJ
Endosulfan I	UG/L	0.0192 U	0.0182 UJ	0.0187 UJ
Endosulfan II	UG/L	0.0385 U	0.0364 UJ	0.03745 UJ
Endosulfan sulfate	UG/L	0.0385 U	0.0364 UJ	0.03745 UJ

Table A-1E
SEAD-71 Groundwater Sample-Duplicate Merged Results
SEAD-59 AND SEAD-71 PHASE II RI REPORT
Seneca Army Depot Activity

	Facility	SEAD-71	SEAD-71	SEAD-71
	Location ID	MW71-4	MW71-4	MW71-4
	Maxtrix	GROUNDWATER	GROUNDWATER	GROUNDWATER
	Sample ID	712003	712002	712003/712002
	Sample Depth to Top of Sample	20.67	20.67	20.67
	Sample Depth to Bottom of Sample	20.67	20.67	20.67
	Sample Date	4/5/2004	4/5/2004	4/5/2004
	QC Code	SA	SA	SA/DU
	Study ID	RI 2004	RI 2004	RI 2004
		1	1	1
Parameter	Units	Value (Q)	Value (Q)	Value (Q)
Endrin	UG/L	0.0385 U	0.0364 UJ	0.03745 UJ
Endrin aldehyde	UG/L	0.0385 U	0.0364 UJ	0.03745 UJ
Endrin ketone	UG/L	0.0385 U	0.0364 UJ	0.03745 UJ
Gamma-BHC/Lindane	UG/L	0.0192 U	0.0182 UJ	0.0187 UJ
Heptachlor	UG/L	0.0192 U	0.0182 UJ	0.0187 UJ
Heptachlor epoxide	UG/L	0.0192 U	0.0182 UJ	0.0187 UJ
Methoxychlor	UG/L	0.192 U	0.182 UJ	0.187 UJ
Toxaphene	UG/L	0.962 U	0.909 UJ	0.9355 UJ
Aroclor-1016	UG/L	0.481 U	0.454 UJ	0.4675 UJ
Aroclor-1221	UG/L	0.481 U	0.454 UJ	0.4675 UJ
Aroclor-1232	UG/L	0.481 U	0.454 UJ	0.4675 UJ
Aroclor-1242	UG/L	0.481 U	0.454 UJ	0.4675 UJ
Aroclor-1248	UG/L	0.481 U	0.454 UJ	0.4675 UJ
Aroclor-1254	UG/L	0.481 U	0.454 UJ	0.4675 UJ
Aroclor-1260	UG/L	0.481 U	0.454 UJ	0.4675 UJ
Metals				
Aluminum	UG/L	14.7 U	14.7 U	14.7 U
Antimony	UG/L	7.4 J	5.16 J	6.28 J
Arsenic	UG/L	22.4 U	22.4 U	22.4 U
Barium	UG/L	63.3	62.4	62.85
Beryllium	UG/L	0.158 U	0.158 U	0.158 U
Cadmium	UG/L	0.313 U	0.313 U	0.313 U
Calcium	UG/L	178000	178000	178000
Chromium	UG/L	0.503 U	0.503 U	0.503 U
Cobalt	UG/L	0.541 U	0.541 U	0.541 U
Copper	UG/L	1.44 J	1.41 J	1.425 J
Iron	UG/L	24.7 J	21.1 J	22.9 J
Lead	UG/L	1.72 U	1.72 U	1.72 U
Magnesium	UG/L	21700	21600	21650
Manganese	UG/L	0.296 U	0.296 U	0.296 U
Mercury	UG/L	0.047 U	0.047 U	0.047 U
Nickel	UG/L	0.69 U	0.69 U	0.69 U
Potassium	UG/L	1090 J	1090 J	1090 J
Selenium	UG/L	2.81 U	2.81 U	2.81 U
Silver	UG/L	0.835 U	0.835 U	0.835 U
Sodium	UG/L	42500	41600	42050
Thallium	UG/L	10 U	10 U	10 U
Vanadium	UG/L	0.606 U	0.606 U	0.606 U
Zinc	UG/L	8.48	8.5	8.49

Notes:

Averging Procedure below

A - SA/DU chem values were then averaged

B - SA/DU Qualifiers were selected to represent the discreet sample.

C - SA/DU sample ID were combined and are marked with "SA/DU"

**Table A-2A
SURFACE SOIL SAMPLE RESULTS (0-2 ft.)
SEAD-59
SEAD-59 and SEAD-71 Phase II RI Report
Seneca Army Depot Activity**

Facility	SEAD-59	SEAD-59	SEAD-59	SEAD-59	SEAD-59	SEAD-59
Location ID	CL-59-01-F02	CL-59-01-F03	CL-59-01-F04	CL-59-01-F05	CL-59-01-F06	CL-59-01-F07
Maxtrix	SOIL	SOIL	SOIL	SOIL	SOIL	SOIL
Sample ID	CL-59-01-F02	CL-59-01-F03	CL-59-01-F04	CL-59-01-F05	CL-59-01-F06	CL-59-01-F07
Sample Depth to Top of Sample ⁽¹⁾	0	0	0	0	0	0
Sample Depth to Bottom of Sample ⁽¹⁾	0	0	0	0	0	0
Sample Date	5/6/2004	5/6/2004	5/6/2004	5/6/2004	5/6/2004	5/6/2004
QC Code	SA	SA	SA	SA	SA	SA
Study ID	ENSR IRM	ENSR IRM	ENSR IRM	ENSR IRM	ENSR IRM	ENSR IRM
Sample Round	1	1	1	1	1	1

Parameter	Units	Maximum Value	Frequency of Detection	NYSDEC TAGM 4046 ⁽²⁾	Number of Exceedances	Number of Detects	Number of Analyses ⁽³⁾	Value (Q)	Value (Q)	Value (Q)	Value (Q)	Value (Q)	Value (Q)
Volatile Organics													
1,1,1-Trichloroethane	UG/KG	0	0%	800	0	0	177	5 U	6 R	6 U	6 U	5 U	5 U
1,1,2,2-Tetrachloroethane	UG/KG	0	0%	600	0	0	169	5 U	6 R	6 U	6 U	5 UJ	5 U
1,1,2-Trichloro-1,2,2-Trifluoroethane	UG/KG	0	0%		0	0	168	5 UJ	6 R	6 U	6 U	5 U	5 U
1,1,2-Trichloroethane	UG/KG	0	0%		0	0	107	5 U	6 R		6 U	5 U	5 U
1,1-Dichloroethane	UG/KG	0	0%	200	0	0	177	5 U	6 R	6 U	6 U	5 U	5 U
1,1-Dichloroethene	UG/KG	8	2%	400	0	3	177	5 U	6 R	6 U	6 U	5 U	5 U
1,2,3-Trichloropropane	UG/KG	0	0%		0	0	70			6 U			
1,2,4-Trichlorobenzene	UG/KG	0	0%	3400	0	0	161	5 UJ	6 R	6 U	6 U	5 UJ	5 U
1,2-Dibromo-3-chloropropane	UG/KG	0	0%		0	0	91	5 UJ	6 R		6 U	5 UJ	5 U
1,2-Dibromoethane	UG/KG	0	0%		0	0	98	5 U	6 R		6 U	5 U	5 U
1,2-Dichlorobenzene	UG/KG	0	0%	7900	0	0	161	5 UJ	6 R	6 U	6 U	5 UJ	5 U
1,2-Dichloroethane	UG/KG	0	0%	100	0	0	177	5 U	6 R	6 U	6 U	5 U	5 U
1,2-Dichloroethene (total)	UG/KG	0	0%		0	0	9						
1,2-Dichloropropane	UG/KG	0	0%		0	0	107	5 U	6 R		6 U	5 U	5 U
1,3-Dichlorobenzene	UG/KG	0	0%	1600	0	0	161	5 UJ	6 R	6 U	6 U	5 UJ	5 U
1,3-Dichloropropane	UG/KG	0	0%		0	0	70			6 U			
1,4-Dichlorobenzene	UG/KG	0	0%	8500	0	0	161	5 UJ	6 R	6 U	6 U	5 UJ	5 U
Acetone	UG/KG	550	27%	200	2	47	177	5 U	6 R	9.6 J	41 NJ	31 NJ	47 NJ
Benzene	UG/KG	3	4%	60	7	7	177	5 U	6 R	6 U		5 U	5 U
Bromodichloromethane	UG/KG	0	0%		0	0	107	5 U	6 R		6 U	5 U	5 U
Bromoform	UG/KG	0	0%		0	0	107	5 U	6 R		6 U	5 U	5 U
Carbon disulfide	UG/KG	4	3%	2700	0	6	177	5 U	6 R	6 U	6 U	5 U	5 U
Carbon tetrachloride	UG/KG	0	0%	600	0	0	177	5 U	6 R	6 U	6 U	5 U	5 U
Chlorobenzene	UG/KG	0	0%	1700	0	0	177	5 U	6 R	6 U	6 U	5 U	5 U
Chlorodibromomethane	UG/KG	0	0%		0	0	177	5 U	6 R	6 U	6 U	5 U	5 U
Chloroethane	UG/KG	0	0%	1900	0	0	177	5 U	6 R	12 U	6 U	5 U	5 U
Chloroform	UG/KG	0	0%	300	0	0	177	5 U	6 R	6 U	6 U	5 U	5 U
Cis-1,2-Dichloroethene	UG/KG	0	0%		0	0	98	5 U	6 R		6 U	5 U	5 U
Cis-1,3-Dichloropropene	UG/KG	0	0%		0	0	107	5 U	6 R		6 U	5 U	5 U
Cyclohexane	UG/KG	3	8%		0	8	98	5 U	6 R		6 U	5 U	5 U
Dichlorodifluoromethane	UG/KG	0	0%		0	0	98	5 UJ	6 R		6 U	5 U	5 U
Ethyl benzene	UG/KG	4.6	1%	5500	0	2	177	5 U	6 R	6 U	6 U	5 U	5 U
Isopropylbenzene	UG/KG	0	0%		0	0	98	5 U	6 R		6 U	5 U	5 U
Meta/Para Xylene	UG/KG	9.4	4%		0	3	70			6 U			
Methyl Acetate	UG/KG	2	3%		0	3	98	5 U	6 R		6 U	5 U	5 U
Methyl Tertbutyl Ether	UG/KG	0	0%		0	0	98	5 U	6 R		6 U	5 U	5 U
Methyl bromide	UG/KG	0	0%		0	0	107	5 U	6 R		6 U	5 U	5 U
Methyl butyl ketone	UG/KG	0	0%		0	0	107	5 U	6 R		6 U	5 U	5 U
Methyl chloride	UG/KG	0	0%		0	0	107	5 U	6 R		6 U	5 U	5 U
Methyl cyclohexane	UG/KG	5	10%		0	10	98	5 U	6 R		6 U	5 U	5 U
Methyl ethyl ketone	UG/KG	190	12%	300	0	22	177	5 U	6 R	12 U	6 U	5 U	5 U
Methyl isobutyl ketone	UG/KG	1.9	1%	1000	0	1	177	5 U	6 R	12 U	6 U	5 U	5 U
Methylene chloride	UG/KG	4.9	20%	100	0	36	178	5 U	6 UJ	6 U	6 U	5 U	5 U
Ortho Xylene	UG/KG	5.05	4%		0	3	70			6 U			

Table A-2A
SURFACE SOIL SAMPLE RESULTS (0-2 ft.)
SEAD-59
SEAD-59 and SEAD-71 Phase II RI Report
Seneca Army Depot Activity

Facility	SEAD-59						SEAD-59						
Location ID	CL-59-01-F02		CL-59-01-F03		CL-59-01-F04		CL-59-01-F05		CL-59-01-F06		CL-59-01-F07		
Maxtrix	SOIL						SOIL						
Sample ID	CL-59-01-F02		CL-59-01-F03		CL-59-01-F04		CL-59-01-F05		CL-59-01-F06		CL-59-01-F07		
Sample Depth to Top of Sample ⁽¹⁾	0						0						
Sample Depth to Bottom of Sample ⁽¹⁾	0						0						
Sample Date	5/6/2004		5/6/2004		5/6/2004		5/6/2004		5/6/2004		5/6/2004		
QC Code	SA		SA		SA		SA		SA		SA		
Study ID	ENSR IRM		ENSR IRM		ENSR IRM		ENSR IRM		ENSR IRM		ENSR IRM		
Sample Round	1		1		1		1		1		1		
Parameter	Units	Maximum Value	Frequency of Detection	NYSDEC TAGM 4046 ⁽²⁾	Number of Exceedances	Number of Detects	Number of Analyses ⁽³⁾	Value (Q)	Value (Q)	Value (Q)	Value (Q)	Value (Q)	Value (Q)
Styrene	UG/KG	0	0%		0	0	107	5 U	6 R		6 U	5 U	5 U
Tetrachloroethene	UG/KG	6.4	3%	1400	0	5	177	5 U	6 R	6 U	6 U	5 U	5 U
Toluene	UG/KG	8	8%	1500	0	14	177	5 U	6 R	6 U	6 U	5 U	5 U
Total BTEX	MG/KG	3.25	67%		0	2	3						
Total Xylenes	UG/KG	3	7%	1200	0	7	102	5 UJ	6 R		6 U	5 UJ	5 U
Trans-1,2-Dichloroethene	UG/KG	0	0%	300	0	0	168	5 U	6 R	6 U	6 U	5 U	5 U
Trans-1,3-Dichloropropene	UG/KG	0	0%		0	0	107	5 U	6 R		6 U	5 U	5 U
Trichloroethene	UG/KG	4.5	5%	700	0	8	177	5 U	6 R	6 U	6 U	5 U	5 U
Trichlorofluoromethane	UG/KG	6	1%		0	1	98	5 UJ	6 R		6 U	5 U	5 U
Vinyl chloride	UG/KG	0	0%	200	0	0	177	5 U	6 R	12 U	6 U	5 U	5 U
Semivolatile Organics													
1,1'-Biphenyl	UG/KG	254.5	2%		0	2	99	380 U	410 U		390 U	370 U	410 U
1,2,4-Trichlorobenzene	UG/KG	0	0%	3400	0	0	9						
1,2-Dichlorobenzene	UG/KG	0	0%	7900	0	0	9						
1,3-Dichlorobenzene	UG/KG	0	0%	1600	0	0	9						
1,4-Dichlorobenzene	UG/KG	0	0%	8500	0	0	9						
2,2'-oxybis(1-Chloropropane)	UG/KG	0	0%		0	0	105	380 U	410 UJ		390 U	370 U	410 U
2,4,5-Trichlorophenol	UG/KG	0	0%	100	0	0	178	950 U	1000 U	390 U	980 U	940 U	1000 U
2,4,6-Trichlorophenol	UG/KG	0	0%		0	0	178	380 U	410 U	390 U	390 U	370 U	410 U
2,4-Dichlorophenol	UG/KG	0	0%	400	0	0	178	380 U	410 U	390 U	390 U	370 U	410 U
2,4-Dimethylphenol	UG/KG	0	0%		0	0	108	380 U	410 U		390 U	370 U	410 U
2,4-Dinitrophenol	UG/KG	0	0%	200	0	0	178	950 U	1000 U	2000 U	980 U	940 U	1000 U
2,4-Dinitrotoluene	UG/KG	0	0%		0	0	178	380 U	410 U	390 U	390 U	370 U	410 U
2,6-Dinitrotoluene	UG/KG	0	0%	1000	0	0	178	380 U	410 U	390 U	390 U	370 U	410 U
2-Chloronaphthalene	UG/KG	0	0%		0	0	108	380 U	410 U		390 U	370 U	410 U
2-Chlorophenol	UG/KG	0	0%	800	0	0	178	380 U	410 U	390 U	390 U	370 U	410 U
2-Methylnaphthalene	UG/KG	1295	19%	36400	0	34	178	380 U	410 U	390 U	390 U	370 U	42 J
2-Methylphenol	UG/KG	0	0%	100	0	0	178	380 U	410 U	390 U	390 U	370 U	410 U
2-Nitroaniline	UG/KG	0	0%	430	0	0	178	950 U	1000 U	2000 U	980 U	940 U	1000 U
2-Nitrophenol	UG/KG	0	0%	330	0	0	178	380 U	410 U	390 U	390 U	370 U	410 U
3,3'-Dichlorobenzidine	UG/KG	0	0%		0	0	178	380 U	410 UJ	390 U	390 U	370 U	410 U
3-Nitroaniline	UG/KG	0	0%	500	0	0	178	950 U	1000 U	2000 U	980 U	940 U	1000 U
4,6-Dinitro-2-methylphenol	UG/KG	0	0%		0	0	108	950 U	1000 U		980 U	940 U	1000 U
4-Bromophenyl phenyl ether	UG/KG	0	0%		0	0	108	380 U	410 U		390 U	370 U	410 U
4-Chloro-3-methylphenol	UG/KG	0	0%	240	0	0	178	380 U	410 U	390 U	390 U	370 U	410 U
4-Chloroaniline	UG/KG	1200	1%	220	1	2	178	380 U	410 U	390 U	390 U	370 U	410 U
4-Chlorophenyl phenyl ether	UG/KG	0	0%		0	0	108	380 U	410 U		390 U	370 U	410 U
4-Methylphenol	UG/KG	150	3%	900	0	5	178	380 U	410 U	390 U	390 U	370 U	410 U
4-Nitroaniline	UG/KG	0	0%		0	0	108	950 U	1000 U		980 U	940 U	1000 U
4-Nitrophenol	UG/KG	0	0%	100	0	0	178	950 U	1000 U	2000 U	980 U	940 U	1000 U
Acenaphthene	UG/KG	2680	24%	50000	0	42	178	380 U	410 U	390 U	390 U	370 U	410 U
Acenaphthylene	UG/KG	1700	37%	41000	0	66	178	380 U	410 U	76 J	390 U	370 U	410 U
Acetophenone	UG/KG	0	0%		0	0	99	380 U	410 U		390 U	370 U	410 U
Aniline	UG/KG	0	0%		0	0	70			390 U			
Anthracene	UG/KG	4395	43%	50000	0	77	178	380 U	410 U	82 J	390 U	370 U	410 U

**Table A-2A
SURFACE SOIL SAMPLE RESULTS (0-2 ft.)
SEAD-59
SEAD-59 and SEAD-71 Phase II RI Report
Seneca Army Depot Activity**

Facility	SEAD-59						SEAD-59						
Location ID	CL-59-01-F02		CL-59-01-F03		CL-59-01-F04		CL-59-01-F05		CL-59-01-F06		CL-59-01-F07		
Maxtrix	SOIL						SOIL						
Sample ID	CL-59-01-F02		CL-59-01-F03		CL-59-01-F04		CL-59-01-F05		CL-59-01-F06		CL-59-01-F07		
Sample Depth to Top of Sample ⁽¹⁾	0						0						
Sample Depth to Bottom of Sample ⁽¹⁾	0						0						
Sample Date	5/6/2004		5/6/2004		5/6/2004		5/6/2004		5/6/2004		5/6/2004		
QC Code	SA		SA		SA		SA		SA		SA		
Study ID	ENSR IRM		ENSR IRM		ENSR IRM		ENSR IRM		ENSR IRM		ENSR IRM		
Sample Round	1		1		1		1		1		1		
Parameter	Units	Maximum Value	Frequency of Detection	NYSDEC TAGM 4046 ⁽²⁾	Number of Exceedances	Number of Detects	Number of Analyses ⁽³⁾	Value (Q)	Value (Q)	Value (Q)	Value (Q)	Value (Q)	Value (Q)
Atrazine	UG/KG	120	1%		0	1	99	380 U	410 U		390 U	370 U	410 U
Benzaldehyde	UG/KG	50	1%		0	1	99	380 U	410 U		390 U	370 U	410 U
Benzo(a)anthracene	UG/KG	8900	51%	224	72	90	178	380 U	410 U	240 J	390 U	370 U	86 NJ
Benzo(a)pyrene	UG/KG	8050	51%	61	84	91	178	380 U	410 U	270 J	390 U	370 U	95 J
Benzo(b)fluoranthene	UG/KG	6800	52%	1100	40	92	178	380 U	410 U	200 J	390 U	370 U	120 J
Benzo(ghi)perylene	UG/KG	5200	46%	50000	0	82	178	380 U	410 U	190 J	390 U	370 U	53 J
Benzo(k)fluoranthene	UG/KG	7350	49%	1100	35	88	178	380 U	410 U	200 J	390 U	370 U	48 J
Benzoic Acid	UG/KG	0	0%	2700	0	0	70			2000 U			
Bis(2-Chloroethoxy)methane	UG/KG	0	0%		0	0	108	380 U	410 U		390 U	370 U	410 U
Bis(2-Chloroethyl)ether	UG/KG	0	0%		0	0	108	380 U	410 U		390 U	370 U	410 U
Bis(2-Chloroisopropyl)ether	UG/KG	0	0%		0	0	3						
Bis(2-Ethylhexyl)phthalate	UG/KG	990	19%	50000	0	34	178	380 U	410 U	390 U	41 J	40 J	410 U
Butylbenzylphthalate	UG/KG	0	0%	50000	0	0	178	380 U	410 U	390 U	390 U	370 U	410 U
Caprolactam	UG/KG	0	0%		0	0	99	380 U	410 U		390 U	370 U	410 U
Carbazole	UG/KG	755	19%		0	20	108	380 U	410 U		390 U	370 U	410 U
Chrysene	UG/KG	8900	51%	400	62	91	178	380 U	410 U	260 J	390 U	370 U	90 J
Di-n-butylphthalate	UG/KG	965	2%	8100	0	4	178	380 U	410 U	390 U	390 U	370 U	410 U
Di-n-octylphthalate	UG/KG	0	0%	50000	0	0	178	380 U	410 U	390 U	390 U	370 U	410 U
Dibenz(a,h)anthracene	UG/KG	1665	38%	14	67	68	178	380 U	410 U	59 J	390 U	370 U	410 U
Dibenzofuran	UG/KG	2350	16%	6200	0	28	178	380 U	410 U	390 U	390 U	370 U	410 U
Diethyl phthalate	UG/KG	10	1%	7100	0	1	178	380 U	410 U	390 U	390 U	370 U	410 U
Dimethylphthalate	UG/KG	0	0%	2000	0	0	178	380 U	410 U	390 U	390 U	370 U	410 U
Fluoranthene	UG/KG	23500	54%	50000	0	97	178	380 U	410 U	480 J	390 U	370 U	140 J
Fluorene	UG/KG	2640	28%	50000	0	49	178	380 U	410 U	390 U	390 U	370 U	410 U
Hexachlorobenzene	UG/KG	0	0%	410	0	0	178	380 U	410 U	390 U	390 U	370 U	410 U
Hexachlorobutadiene	UG/KG	0	0%		0	0	178	380 U	410 U	390 U	390 U	370 U	410 U
Hexachlorocyclopentadiene	UG/KG	0	0%		0	0	108	380 U	410 U		390 U	370 U	410 U
Hexachloroethane	UG/KG	0	0%		0	0	178	380 U	410 U	390 U	390 U	370 U	410 U
Indeno(1,2,3-cd)pyrene	UG/KG	4950	47%	3200	2	84	178	380 U	410 U	180 J	390 U	370 U	57 J
Isophorone	UG/KG	0	0%	4400	0	0	178	380 U	410 U	390 U	390 U	370 U	410 U
N-Nitrosodiphenylamine	UG/KG	100	1%		0	1	108	380 U	410 U		390 U	370 U	410 U
N-Nitrosodipropylamine	UG/KG	0	0%		0	0	108	380 U	410 U		390 U	370 U	410 U
Naphthalene	UG/KG	1800	19%	13000	0	34	178	380 U	410 U	390 U	390 U	370 U	53 J
Nitrobenzene	UG/KG	0	0%	200	0	0	178	380 U	410 U	390 U	390 U	370 U	410 U
Pentachlorophenol	UG/KG	0	0%	1000	0	0	178	950 U	1000 U	2000 U	980 U	940 U	1000 U
Phenanthrene	UG/KG	21300	51%	50000	0	90	178	380 U	410 U	210 J	390 U	370 U	110 J
Phenol	UG/KG	0	0%	30	0	0	178	380 U	410 U	390 U	390 U	370 U	410 U
Pyrene	UG/KG	19200	55%	50000	0	98	178	380 U	410 U	440 J	390 U	370 U	140 J
Pyridine	UG/KG	0	0%		0	0	100		410 U	2000 U			
Total Unknown PAHs as SV	MG/KG	25	100%		0	3	3						
Pesticides/PCBs													
4,4'-DDD	UG/KG	740	28%	2900	0	49	178	3.8 U	4.1 U	20 U	3.9 U	3.8 U	4.1 U
4,4'-DDE	UG/KG	2600	37%	2100	1	65	178	3.8 U	4.1 U	20 U	3.9 U	3.8 U	17 NJ
4,4'-DDT	UG/KG	3700	33%	2100	1	59	178	3.8 U	4.1 U	20 U	3.9 U	3.8 U	4.1 U
Aldrin	UG/KG	1.2	1%	41	0	1	178	1.9 U	2.1 U	10 U	2 U	2 U	2.1 U

**Table A-2A
SURFACE SOIL SAMPLE RESULTS (0-2 ft.)
SEAD-59
SEAD-59 and SEAD-71 Phase II RI Report
Seneca Army Depot Activity**

Facility	SEAD-59						SEAD-59						
Location ID	CL-59-01-F02		CL-59-01-F03		CL-59-01-F04		CL-59-01-F05		CL-59-01-F06		CL-59-01-F07		
Maxtrix	SOIL						SOIL						
Sample ID	CL-59-01-F02		CL-59-01-F03		CL-59-01-F04		CL-59-01-F05		CL-59-01-F06		CL-59-01-F07		
Sample Depth to Top of Sample ⁽¹⁾	0						0						
Sample Depth to Bottom of Sample ⁽¹⁾	0						0						
Sample Date	5/6/2004		5/6/2004		5/6/2004		5/6/2004		5/6/2004		5/6/2004		
QC Code	SA		SA		SA		SA		SA		SA		
Study ID	ENSR IRM		ENSR IRM		ENSR IRM		ENSR IRM		ENSR IRM		ENSR IRM		
Sample Round	1		1		1		1		1		1		
Parameter	Units	Maximum Value	Frequency of Detection	NYSDEC TAGM 4046 ⁽²⁾	Number of Exceedances	Number of Detects	Number of Analyses ⁽³⁾	Value (Q)	Value (Q)	Value (Q)	Value (Q)	Value (Q)	Value (Q)
Alpha-BHC	UG/KG	0	0%	110	0	0	178	1.9 U	2.1 U	10 U	2 U	2 U	2.1 U
Alpha-Chlordane	UG/KG	34	4%		0	7	178	1.9 U	2.1 U	10 U	2 U	2 U	2.1 U
Beta-BHC	UG/KG	2.4	1%	200	0	1	178	1.9 U	2.1 U	10 U	2 U	2 U	2.1 U
Delta-BHC	UG/KG	0	0%	300	0	0	178	1.9 U	2.1 U	10 U	2 U	2 U	2.1 U
Dieldrin	UG/KG	0	0%	44	0	0	178	3.8 U	4.1 U	20 U	3.9 U	3.8 U	4.1 U
Endosulfan I	UG/KG	16	1%	900	0	1	178	1.9 U	2.1 U	10 U	2 U	2 U	2.1 U
Endosulfan II	UG/KG	0	0%	900	0	0	178	3.8 U	4.1 U	20 U	3.9 U	3.8 U	4.1 U
Endosulfan sulfate	UG/KG	6.2	1%	1000	0	1	178	3.8 U	4.1 U	20 U	3.9 U	3.8 U	4.1 U
Endrin	UG/KG	16	2%	100	0	3	178	3.8 U	4.1 U	20 U	3.9 U	3.8 U	4.1 U
Endrin aldehyde	UG/KG	4.9	1%		0	2	178	3.8 U	4.1 U	20 U	3.9 U	3.8 U	4.1 U
Endrin ketone	UG/KG	38	2%		0	4	178	3.8 U	4.1 U	20 U	3.9 U	3.8 U	4.1 U
Gamma-BHC/Lindane	UG/KG	0	0%	60	0	0	178	1.9 U	2.1 U	10 U	2 U	2 U	2.1 U
Gamma-Chlordane	UG/KG	24	8%	540	0	14	178	1.9 U	2.1 U	10 U	2 U	2 U	2.1 U
Heptachlor	UG/KG	0	0%	100	0	0	178	1.9 U	2.1 U	10 U	2 U	2 U	2.1 U
Heptachlor epoxide	UG/KG	3	1%	20	0	2	178	1.9 U	2.1 U	10 U	2 U	2 U	2.1 U
Methoxychlor	UG/KG	0	0%		0	0	178	19 U	21 U	100 U	20 U	20 U	21 U
Toxaphene	UG/KG	0	0%		0	0	178	190 U	210 U	200 U	200 U	200 U	210 U
Aroclor-1016	UG/KG	0	0%		0	0	178	38 U	41 U	39 U	40 U	39 U	42 U
Aroclor-1221	UG/KG	0	0%		0	0	178	38 U	41 U	39 U	40 U	39 U	42 U
Aroclor-1232	UG/KG	0	0%		0	0	178	38 U	41 U	39 U	40 U	39 U	42 U
Aroclor-1242	UG/KG	0	0%		0	0	178	38 U	41 U	39 U	40 U	39 U	42 U
Aroclor-1248	UG/KG	0	0%		0	0	178	38 U	41 U	39 U	40 U	39 U	42 U
Aroclor-1254	UG/KG	0	0%	10000	0	0	178	38 U	41 U	39 U	40 U	39 U	42 U
Aroclor-1260	UG/KG	79	1%	10000	0	2	178	38 U	41 U	39 U	40 U	39 U	42 U
Metals													
Aluminum	MG/KG	18300	100%	19300	0	178	178	11300 J	13100	9840	12200 J	10600 J	10400 J
Antimony	MG/KG	424	58%	5.9	5	104	178	1.7 J	2 J	3.5 UJ	1.2 J	1.4 J	1.4 J
Arsenic	MG/KG	32.2	100%	8.2	7	178	178	9.5	4.7	3.2 J	6.8 J	7.5 J	5.7 J
Barium	MG/KG	304	100%	300	1	178	178	111 J	117 J	99.9	102 J	89.8 J	109 J
Beryllium	MG/KG	2.6	99%	1.1	2	176	178	0.69	0.68	0.19	0.61	0.56	0.55
Cadmium	MG/KG	3.2	86%	2.3	2	153	178	0.31	0.65	0.29 U	0.42	0.3 J	0.27 J
Calcium	MG/KG	214000	100%	121000	1	178	178	3130 J	3140	7970	2790 J	3080 J	21600 J
Chromium	MG/KG	39.3	100%	29.6	2	178	178	19 J	19.8 J	15.2	18.4 J	16.2 J	16.9 J
Cobalt	MG/KG	47.8	100%	30	2	178	178	10.2 J	10.7	7.8	9.7 J	9.5 J	7.8 J
Copper	MG/KG	305	100%	33	19	178	178	25.3 J	18.5	17.5 J	22.9 J	22.9 J	20.4 J
Cyanide	MG/KG	0	0%	0.35	0	0	9						
Iron	MG/KG	64000	100%	36500	1	178	178	31900	24700	17900 J	24700 J	23300 J	22600 J
Lead	MG/KG	164	100%	24.8	75	178	178	14.6 J	12.8 J	17.2	13.1 J	14 J	12 J
Magnesium	MG/KG	30200	100%	21500	3	178	178	4360 J	4620 J	3990	5000 J	4560 J	9820 J
Manganese	MG/KG	1290	100%	1060	3	178	178	361 J	623 J	464	516 J	1050 J	428 J
Mercury	MG/KG	0.95	95%	0.1	37	169	178	0.04	0.04	0.04	0.03	0.03 J	0.03 J
Nickel	MG/KG	88.3	100%	49	3	178	178	30.8 J	32.8 J	22.7	30.3 J	29.3 J	27.7 J
Potassium	MG/KG	2290	100%	2380	0	178	178	1150	911	1030	1070 J	1100 J	969 J
Selenium	MG/KG	1.5	9%	2	0	16	178	0.37 U	0.46 U	0.59 U	0.39 U	0.45 U	0.5 U
Silver	MG/KG	2.9	49%	0.75	62	87	178	1.4	1	0.59 U	1.2	1.5	1
Sodium	MG/KG	4060	99%	172	86	177	178	53.1	150	316	211 J	135 J	184 J

**Table A-2A
SURFACE SOIL SAMPLE RESULTS (0-2 ft.)
SEAD-59
SEAD-59 and SEAD-71 Phase II RI Report
Seneca Army Depot Activity**

				SEAD-59	SEAD-59	SEAD-59	SEAD-59	SEAD-59	SEAD-59	SEAD-59	SEAD-59		
				CL-59-01-F02	CL-59-01-F03	CL-59-01-F04	CL-59-01-F05	CL-59-01-F06	CL-59-01-F07	CL-59-01-F07	CL-59-01-F07		
				SOIL	SOIL	SOIL	SOIL	SOIL	SOIL	SOIL	SOIL		
				CL-59-01-F02	CL-59-01-F03	CL-59-01-F04	CL-59-01-F05	CL-59-01-F06	CL-59-01-F07	CL-59-01-F07	CL-59-01-F07		
Sample Depth to Top of Sample ⁽¹⁾				0	0	0	0	0	0	0	0		
Sample Depth to Bottom of Sample ⁽¹⁾				0	0	0	0	0	0	0	0		
Sample Date				5/6/2004	5/6/2004	5/6/2004	5/6/2004	5/6/2004	5/6/2004	5/6/2004	5/6/2004		
QC Code				SA	SA	SA	SA	SA	SA	SA	SA		
Study ID				ENSR IRM	ENSR IRM	ENSR IRM	ENSR IRM	ENSR IRM	ENSR IRM	ENSR IRM	ENSR IRM		
Sample Round				1	1	1	1	1	1	1	1		
Parameter	Units	Maximum Value	Frequency of Detection	NYSDEC TAGM 4046 ⁽²⁾	Number of Exceedances	Number of Detects	Number of Analyses ⁽³⁾	Value (Q)	Value (Q)	Value (Q)	Value (Q)	Value (Q)	Value (Q)
Thallium	MG/KG	1.8	29%	0.7	24	51	178	0.18 U	0.23 U	0.59 U	0.19 U	0.22 U	0.25 U
Vanadium	MG/KG	28.5	100%	150	0	178	178	24.7 J	21.3 J	16.8	21.8 J	20.8 J	18.2 J
Zinc	MG/KG	341	100%	110	19	178	178	63.2	72.4 J	96.3 J	64.2 J	54.8 J	61.8 J

Note(s):

(1) - Historical sample depths are presented (I.e. prior to 2002 TCRA)

(2) - NYSDEC Technical and Administrative Guidance Memorandum (TAGM) HWR-94-4046, Revised January 24, 1994

(3) - Sample/Duplicate pair are presented as individual samples in this table. Statistical information used Sample Duplicate pairs as a single entity and averaged result values were used in risk assessment analysis.

U = compound was not detected

J = the reported value is an estimated concentration

UJ = the compound was not detected; the associated reporting limit is approximate

R = the data was rejected in the data validating process

NJ = compound was "tentatively identified" and the associated numerical value is approximate

**Table A-2A
SURFACE SOIL SAMPLE RESULTS (0-2 ft.)
SEAD-59
SEAD-59 and SEAD-71 Phase II RI Report
Seneca Army Depot Activity**

Facility	SEAD-59	SEAD-59	SEAD-59	SEAD-59	SEAD-59	SEAD-59
Location ID	CL-59-01-F08	CL-59-01-F09	CL-59-01-F11	CL-59-01-F12	CL-59-01-F13	CL-59-01-F14
Maxtrix	SOIL	SOIL	SOIL	SOIL	SOIL	SOIL
Sample ID	CL-59-01-F08	CL-59-01-F09	CL-59-01-F11	CL-59-01-F12	CL-59-01-F13	CL-59-01-F14
Sample Depth to Top of Sample ⁽¹⁾	0	0	0	0	0	0
Sample Depth to Bottom of Sample ⁽¹⁾	0	0	0	0	0	0
Sample Date	5/6/2004	5/6/2004	5/6/2004	5/6/2004	5/6/2004	5/6/2004
QC Code	SA	SA	SA	SA	SA	SA
Study ID	ENSR IRM	ENSR IRM	ENSR IRM	ENSR IRM	ENSR IRM	ENSR IRM
Sample Round	1	1	1	1	1	1

Parameter	Units	Maximum Value	Frequency of Detection	NYSDEC TAGM 4046 ⁽²⁾	Number of Exceedances	Number of Detects	Number of Analyses ⁽³⁾	Value (Q)	Value (Q)	Value (Q)	Value (Q)	Value (Q)	Value (Q)
Volatile Organics													
1,1,1-Trichloroethane	UG/KG	0	0%	800	0	0	177	5 U	5 U	6 U	6 U	6 U	5 U
1,1,2,2-Tetrachloroethane	UG/KG	0	0%	600	0	0	169	5 U	5 U	6 U	6 U	6 U	5 U
1,1,2-Trichloro-1,2,2-Trifluoroethane	UG/KG	0	0%		0	0	168	5 U	5 U	6 U	6 U	6 U	5 U
1,1,2-Trichloroethane	UG/KG	0	0%		0	0	107	5 U	5 U	6 U	6 U	6 U	5 U
1,1-Dichloroethane	UG/KG	0	0%	200	0	0	177	5 U	5 U	6 U	6 U	6 U	5 U
1,1-Dichloroethene	UG/KG	8	2%	400	0	3	177	5 U	5 U	6 U	6 U	6 U	5 U
1,2,3-Trichloropropane	UG/KG	0	0%		0	0	70						
1,2,4-Trichlorobenzene	UG/KG	0	0%	3400	0	0	161	5 U	5 U	6 U	6 U	6 U	5 U
1,2-Dibromo-3-chloropropane	UG/KG	0	0%		0	0	91	5 U	5 U	6 U	6 U	6 U	5 U
1,2-Dibromoethane	UG/KG	0	0%		0	0	98	5 U	5 U	6 U	6 U	6 U	5 U
1,2-Dichlorobenzene	UG/KG	0	0%	7900	0	0	161	5 U	5 U	6 U	6 U	6 U	5 U
1,2-Dichloroethane	UG/KG	0	0%	100	0	0	177	5 U	5 U	6 U	6 U	6 U	5 U
1,2-Dichloroethene (total)	UG/KG	0	0%		0	0	9						
1,2-Dichloropropane	UG/KG	0	0%		0	0	107	5 U	5 U	6 U	6 U	6 U	5 U
1,3-Dichlorobenzene	UG/KG	0	0%	1600	0	0	161	5 U	5 U	6 U	6 U	6 U	5 U
1,3-Dichloropropane	UG/KG	0	0%		0	0	70						
1,4-Dichlorobenzene	UG/KG	0	0%	8500	0	0	161	5 U	5 U	6 U	6 U	6 U	5 U
Acetone	UG/KG	550	27%	200	2	47	177	98 NJ	18 NJ	10 NJ	28 NJ	66 NJ	56 NJ
Benzene	UG/KG	3	4%	60	0	7	177	5 U	5 U	6 U	6 U	6 U	5 U
Bromodichloromethane	UG/KG	0	0%		0	0	107	5 U	5 U	6 U	6 U	6 U	5 U
Bromoform	UG/KG	0	0%		0	0	107	5 U	5 U	6 U	6 U	6 U	5 U
Carbon disulfide	UG/KG	4	3%	2700	0	6	177	5 U	5 U	6 U	6 U	6 U	1 J
Carbon tetrachloride	UG/KG	0	0%	600	0	0	177	5 U	5 U	6 U	6 U	6 U	5 U
Chlorobenzene	UG/KG	0	0%	1700	0	0	177	5 U	5 U	6 U	6 U	6 U	5 U
Chlorodibromomethane	UG/KG	0	0%		0	0	177	5 U	5 U	6 U	6 U	6 U	5 U
Chloroethane	UG/KG	0	0%	1900	0	0	177	5 U	5 U	6 U	6 U	6 U	5 U
Chloroform	UG/KG	0	0%	300	0	0	177	5 U	5 U	6 U	6 U	6 U	5 U
Cis-1,2-Dichloroethene	UG/KG	0	0%		0	0	98	5 U	5 U	6 U	6 U	6 U	5 U
Cis-1,3-Dichloropropene	UG/KG	0	0%		0	0	107	5 U	5 U	6 U	6 U	6 U	5 U
Cyclohexane	UG/KG	3	8%		0	8	98	5 U	5 U	6 U	6 U	6 U	5 U
Dichlorodifluoromethane	UG/KG	0	0%		0	0	98	5 U	5 U	6 U	6 U	6 U	5 U
Ethyl benzene	UG/KG	4.6	1%	5500	0	2	177	5 U	5 U	6 U	6 U	6 U	5 U
Isopropylbenzene	UG/KG	0	0%		0	0	98	5 U	5 U	6 U	6 U	6 U	5 U
Meta/Para Xylene	UG/KG	9.4	4%		0	3	70						
Methyl Acetate	UG/KG	2	3%		0	3	98	5 U	5 U	6 U	6 U	6 U	5 U
Methyl Tertbutyl Ether	UG/KG	0	0%		0	0	98	5 UJ	5 UJ	6 UJ	6 U	6 U	5 U
Methyl bromide	UG/KG	0	0%		0	0	107	5 UJ	5 UJ	6 UJ	6 U	6 U	5 U
Methyl butyl ketone	UG/KG	0	0%		0	0	107	5 UJ	5 UJ	6 UJ	6 U	6 U	5 U
Methyl chloride	UG/KG	0	0%		0	0	107	5 U	5 U	6 U	6 U	6 U	5 U
Methyl cyclohexane	UG/KG	5	10%		0	10	98	5 U	5 U	6 U	6 U	6 U	5 U
Methyl ethyl ketone	UG/KG	190	12%	300	0	22	177	17 J	5 U	6 U	6 J	11 J	10 J
Methyl isobutyl ketone	UG/KG	1.9	1%	1000	0	1	177	5 UJ	5 UJ	6 UJ	6 U	6 U	5 U
Methylene chloride	UG/KG	4.9	20%	100	0	36	178	5 UJ	5 UJ	6 UJ	6 UJ	6 U	5 U
Ortho Xylene	UG/KG	5.05	4%		0	3	70						

Table A-2A
SURFACE SOIL SAMPLE RESULTS (0-2 ft.)
SEAD-59
SEAD-59 and SEAD-71 Phase II RI Report
Seneca Army Depot Activity

Facility	SEAD-59						SEAD-59						
Location ID	CL-59-01-F08		CL-59-01-F09		CL-59-01-F11		CL-59-01-F12		CL-59-01-F13		CL-59-01-F14		
Maxtrix	SOIL						SOIL						
Sample ID	CL-59-01-F08		CL-59-01-F09		CL-59-01-F11		CL-59-01-F12		CL-59-01-F13		CL-59-01-F14		
Sample Depth to Top of Sample ⁽¹⁾	0						0						
Sample Depth to Bottom of Sample ⁽¹⁾	0						0						
Sample Date	5/6/2004		5/6/2004		5/6/2004		5/6/2004		5/6/2004		5/6/2004		
QC Code	SA						SA						
Study ID	ENSR IRM		ENSR IRM		ENSR IRM		ENSR IRM		ENSR IRM		ENSR IRM		
Sample Round	1		1		1		1		1		1		
Parameter	Units	Maximum Value	Frequency of Detection	NYSDEC TAGM 4046 ⁽²⁾	Number of Exceedances	Number of Detects	Number of Analyses ⁽³⁾	Value (Q)	Value (Q)	Value (Q)	Value (Q)	Value (Q)	Value (Q)
Styrene	UG/KG	0	0%		0	0	107	5 U	5 U	6 U	6 U	6 U	5 U
Tetrachloroethene	UG/KG	6.4	3%	1400	0	5	177	5 U	5 U	6 U	6 U	6 U	5 U
Toluene	UG/KG	8	8%	1500	0	14	177	5 U	5 U	6 U	6 U	6 U	5 U
Total BTEX	MG/KG	3.25	67%		0	2	3						
Total Xylenes	UG/KG	3	7%	1200	0	7	102	5 U	5 U	6 U	6 U	6 U	5 U
Trans-1,2-Dichloroethene	UG/KG	0	0%	300	0	0	168	5 U	5 U	6 U	6 U	6 U	5 U
Trans-1,3-Dichloropropene	UG/KG	0	0%		0	0	107	5 U	5 U	6 U	6 U	6 U	5 U
Trichloroethene	UG/KG	4.5	5%	700	0	8	177	5 U	5 U	6 U	6 U	6 U	5 U
Trichlorofluoromethane	UG/KG	6	1%		0	1	98	5 U	5 U	6 U	6 U	6 U	5 U
Vinyl chloride	UG/KG	0	0%	200	0	0	177	5 U	5 U	6 U	6 U	6 U	5 U
Semivolatile Organics													
1,1'-Biphenyl	UG/KG	254.5	2%		0	2	99	370 U	380 U	390 U	410 U	390 U	380 U
1,2,4-Trichlorobenzene	UG/KG	0	0%	3400	0	0	9						
1,2-Dichlorobenzene	UG/KG	0	0%	7900	0	0	9						
1,3-Dichlorobenzene	UG/KG	0	0%	1600	0	0	9						
1,4-Dichlorobenzene	UG/KG	0	0%	8500	0	0	9						
2,2'-oxybis(1-Chloropropane)	UG/KG	0	0%		0	0	105	370 UJ	380 UJ	390 UJ	410 U	390 UJ	380 UJ
2,4,5-Trichlorophenol	UG/KG	0	0%	100	0	0	178	920 U	960 U	990 U	1000 U	980 U	950 U
2,4,6-Trichlorophenol	UG/KG	0	0%		0	0	178	370 U	380 U	390 U	410 U	390 U	380 U
2,4-Dichlorophenol	UG/KG	0	0%	400	0	0	178	370 U	380 U	390 U	410 U	390 U	380 U
2,4-Dimethylphenol	UG/KG	0	0%		0	0	108	370 U	380 U	390 U	410 U	390 U	380 U
2,4-Dinitrophenol	UG/KG	0	0%	200	0	0	178	920 U	960 U	990 U	1000 U	980 U	950 U
2,4-Dinitrotoluene	UG/KG	0	0%		0	0	178	370 U	380 U	390 U	410 U	390 U	380 U
2,6-Dinitrotoluene	UG/KG	0	0%	1000	0	0	178	370 U	380 U	390 U	410 U	390 U	380 U
2-Chloronaphthalene	UG/KG	0	0%		0	0	108	370 U	380 U	390 U	410 U	390 U	380 U
2-Chlorophenol	UG/KG	0	0%	800	0	0	178	370 U	380 U	390 U	410 U	390 U	380 U
2-Methylnaphthalene	UG/KG	1295	19%	36400	0	34	178	370 U	380 U	390 U	410 U	390 U	380 U
2-Methylphenol	UG/KG	0	0%	100	0	0	178	370 U	380 U	390 U	410 U	390 U	380 U
2-Nitroaniline	UG/KG	0	0%	430	0	0	178	920 U	960 U	990 U	1000 U	980 U	950 U
2-Nitrophenol	UG/KG	0	0%	330	0	0	178	370 U	380 U	390 U	410 U	390 U	380 U
3,3'-Dichlorobenzidine	UG/KG	0	0%		0	0	178	370 UJ	380 UJ	390 UJ	410 U	390 UJ	380 UJ
3-Nitroaniline	UG/KG	0	0%	500	0	0	178	920 U	960 U	990 U	1000 U	980 U	950 U
4,6-Dinitro-2-methylphenol	UG/KG	0	0%		0	0	108	920 U	960 U	990 U	1000 U	980 U	950 U
4-Bromophenyl phenyl ether	UG/KG	0	0%		0	0	108	370 U	380 U	390 U	410 U	390 U	380 U
4-Chloro-3-methylphenol	UG/KG	0	0%	240	0	0	178	370 U	380 U	390 U	410 U	390 U	380 U
4-Chloroaniline	UG/KG	1200	1%	220	1	2	178	370 U	380 U	390 U	410 U	390 U	380 U
4-Chlorophenyl phenyl ether	UG/KG	0	0%		0	0	108	370 U	380 U	390 U	410 U	390 U	380 U
4-Methylphenol	UG/KG	150	3%	900	0	5	178	370 U	380 U	390 U	410 U	390 U	380 U
4-Nitroaniline	UG/KG	0	0%		0	0	108	920 U	960 U	990 U	1000 U	980 U	950 U
4-Nitrophenol	UG/KG	0	0%	100	0	0	178	920 U	960 U	990 U	1000 U	980 U	950 U
Acenaphthene	UG/KG	2680	24%	50000	0	42	178	370 U	380 U	390 U	410 U	390 U	380 U
Acenaphthylene	UG/KG	1700	37%	41000	0	66	178	370 U	53 J	390 U	410 U	390 U	380 U
Acetophenone	UG/KG	0	0%		0	0	99	370 U	380 U	390 U	410 U	390 U	380 U
Aniline	UG/KG	0	0%		0	0	70						
Anthracene	UG/KG	4395	43%	50000	0	77	178	370 U	120 J	390 U	410 U	390 U	380 U

**Table A-2A
SURFACE SOIL SAMPLE RESULTS (0-2 ft.)
SEAD-59
SEAD-59 and SEAD-71 Phase II RI Report
Seneca Army Depot Activity**

Facility	SEAD-59	SEAD-59	SEAD-59	SEAD-59	SEAD-59	SEAD-59							
Location ID	CL-59-01-F08	CL-59-01-F09	CL-59-01-F11	CL-59-01-F12	CL-59-01-F13	CL-59-01-F14							
Maxtrix	SOIL	SOIL	SOIL	SOIL	SOIL	SOIL							
Sample ID	CL-59-01-F08	CL-59-01-F09	CL-59-01-F11	CL-59-01-F12	CL-59-01-F13	CL-59-01-F14							
Sample Depth to Top of Sample ⁽¹⁾	0	0	0	0	0	0							
Sample Depth to Bottom of Sample ⁽¹⁾	0	0	0	0	0	0							
Sample Date	5/6/2004	5/6/2004	5/6/2004	5/6/2004	5/6/2004	5/6/2004							
QC Code	SA	SA	SA	SA	SA	SA							
Study ID	ENSR IRM	ENSR IRM	ENSR IRM	ENSR IRM	ENSR IRM	ENSR IRM							
Sample Round	1	1	1	1	1	1							
Parameter	Units	Maximum Value	Frequency of Detection	NYSDEC TAGM 4046 ⁽²⁾	Number of Exceedances	Number of Detects	Number of Analyses ⁽³⁾	Value (Q)	Value (Q)	Value (Q)	Value (Q)	Value (Q)	Value (Q)
Atrazine	UG/KG	120	1%		0	1	99	370 U	380 U	390 U	410 U	390 U	380 U
Benzaldehyde	UG/KG	50	1%		0	1	99	370 U	380 U	390 U	410 U	390 U	380 U
Benzo(a)anthracene	UG/KG	8900	51%	224	72	90	178	370 U	510 NJ	390 U	410 U	390 U	380 U
Benzo(a)pyrene	UG/KG	8050	51%	61	84	91	178	370 U	520	390 U	410 U	390 U	380 U
Benzo(b)fluoranthene	UG/KG	6800	52%	1100	40	92	178	370 U	630	390 U	410 U	390 U	380 U
Benzo(ghi)perylene	UG/KG	5200	46%	50000	0	82	178	370 U	130 J	390 U	410 U	390 U	380 U
Benzo(k)fluoranthene	UG/KG	7350	49%	1100	35	88	178	370 U	360 J	390 U	410 U	390 U	380 U
Benzoic Acid	UG/KG	0	0%	2700	0	0	70						
Bis(2-Chloroethoxy)methane	UG/KG	0	0%		0	0	108	370 U	380 U	390 U	410 U	390 U	380 U
Bis(2-Chloroethyl)ether	UG/KG	0	0%		0	0	108	370 U	380 U	390 U	410 U	390 U	380 U
Bis(2-Chloroisopropyl)ether	UG/KG	0	0%		0	0	3						
Bis(2-Ethylhexyl)phthalate	UG/KG	990	19%	50000	0	34	178	370 U	39 NJ	390 U	410 U	390 U	380 U
Butylbenzylphthalate	UG/KG	0	0%	50000	0	0	178	370 U	380 U	390 U	410 U	390 U	380 U
Caprolactam	UG/KG	0	0%		0	0	99	370 U	380 U	390 U	410 U	390 U	380 U
Carbazole	UG/KG	755	19%		0	20	108	370 U	380 U	390 U	410 U	390 U	380 U
Chrysene	UG/KG	8900	51%	400	62	91	178	370 U	490	390 U	410 U	390 U	380 U
Di-n-butylphthalate	UG/KG	965	2%	8100	0	4	178	370 U	380 U	390 U	410 U	390 U	380 U
Di-n-octylphthalate	UG/KG	0	0%	50000	0	0	178	370 U	380 U	390 U	410 U	390 U	380 U
Dibenz(a,h)anthracene	UG/KG	1665	38%	14	67	68	178	370 U	39 J	390 U	410 U	390 U	380 U
Dibenzofuran	UG/KG	2350	16%	6200	0	28	178	370 U	380 U	390 U	410 U	390 U	380 U
Diethyl phthalate	UG/KG	10	1%	7100	0	1	178	370 U	380 U	390 U	410 U	390 U	380 U
Dimethylphthalate	UG/KG	0	0%	2000	0	0	178	370 U	380 U	390 U	410 U	390 U	380 U
Fluoranthene	UG/KG	23500	54%	50000	0	97	178	370 U	920	390 U	410 U	390 U	380 U
Fluorene	UG/KG	2640	28%	50000	0	49	178	370 U	71 J	390 U	410 U	390 U	380 U
Hexachlorobenzene	UG/KG	0	0%	410	0	0	178	370 U	380 U	390 U	410 U	390 U	380 U
Hexachlorobutadiene	UG/KG	0	0%		0	0	178	370 U	380 U	390 U	410 U	390 U	380 U
Hexachlorocyclopentadiene	UG/KG	0	0%		0	0	108	370 U	380 U	390 U	410 U	390 U	380 U
Hexachloroethane	UG/KG	0	0%		0	0	178	370 U	380 U	390 U	410 U	390 U	380 U
Indeno(1,2,3-cd)pyrene	UG/KG	4950	47%	3200	2	84	178	370 U	140 J	390 U	410 U	390 U	380 U
Isophorone	UG/KG	0	0%	4400	0	0	178	370 U	380 U	390 U	410 U	390 U	380 U
N-Nitrosodiphenylamine	UG/KG	100	1%		0	1	108	370 U	380 U	390 U	410 U	390 U	380 U
N-Nitrosodipropylamine	UG/KG	0	0%		0	0	108	370 U	380 U	390 U	410 U	390 U	380 U
Naphthalene	UG/KG	1800	19%	13000	0	34	178	370 U	380 U	390 U	410 U	390 U	380 U
Nitrobenzene	UG/KG	0	0%	200	0	0	178	370 U	380 U	390 U	410 U	390 U	380 U
Pentachlorophenol	UG/KG	0	0%	1000	0	0	178	920 U	960 U	990 U	1000 U	980 U	950 U
Phenanthrene	UG/KG	21300	51%	50000	0	90	178	370 U	360 J	390 U	410 U	390 U	380 U
Phenol	UG/KG	0	0%	30	0	0	178	370 U	380 U	390 U	410 U	390 U	380 U
Pyrene	UG/KG	19200	55%	50000	0	98	178	370 U	960	390 U	410 U	390 U	380 U
Pyridine	UG/KG	0	0%		0	0	100	370 U	380 U	390 U	410 U	390 U	380 U
Total Unknown PAHs as SV	MG/KG	25	100%		0	3	3						
Pesticides/PCBs													
4,4'-DDD	UG/KG	740	28%	2900	0	49	178	3.6 U	3.7 U	3.9 U	4 U	4 U	3.7 U
4,4'-DDE	UG/KG	2600	37%	2100	1	65	178	3.6 U	10	3.9 U	4.7	4 U	3.7 U
4,4'-DDT	UG/KG	3700	33%	2100	1	59	178	3.6 U	3.7 U	3.9 U	4 U	4 U	3.7 U
Aldrin	UG/KG	1.2	1%	41	0	1	178	1.9 U	1.9 U	2 U	2.1 U	2 U	1.9 U

**Table A-2A
SURFACE SOIL SAMPLE RESULTS (0-2 ft.)
SEAD-59
SEAD-59 and SEAD-71 Phase II RI Report
Seneca Army Depot Activity**

Facility	SEAD-59	SEAD-59	SEAD-59	SEAD-59	SEAD-59	SEAD-59							
Location ID	CL-59-01-F08	CL-59-01-F09	CL-59-01-F11	CL-59-01-F12	CL-59-01-F13	CL-59-01-F14							
Maxtrix	SOIL	SOIL	SOIL	SOIL	SOIL	SOIL							
Sample ID	CL-59-01-F08	CL-59-01-F09	CL-59-01-F11	CL-59-01-F12	CL-59-01-F13	CL-59-01-F14							
Sample Depth to Top of Sample ⁽¹⁾	0	0	0	0	0	0							
Sample Depth to Bottom of Sample ⁽¹⁾	0	0	0	0	0	0							
Sample Date	5/6/2004	5/6/2004	5/6/2004	5/6/2004	5/6/2004	5/6/2004							
QC Code	SA	SA	SA	SA	SA	SA							
Study ID	ENSR IRM	ENSR IRM	ENSR IRM	ENSR IRM	ENSR IRM	ENSR IRM							
Sample Round	1	1	1	1	1	1							
Parameter	Units	Maximum Value	Frequency of Detection	NYSDEC TAGM 4046 ⁽²⁾	Number of Exceedances	Number of Detects	Number of Analyses ⁽³⁾	Value (Q)	Value (Q)	Value (Q)	Value (Q)	Value (Q)	Value (Q)
Alpha-BHC	UG/KG	0	0%	110	0	0	178	1.9 U	1.9 U	2 U	2.1 U	2 U	1.9 U
Alpha-Chlordane	UG/KG	34	4%		0	7	178	1.9 U	1.9 U	2 U	2.1 U	2 U	1.9 U
Beta-BHC	UG/KG	2.4	1%	200	0	1	178	1.9 U	1.9 U	2 U	2.1 U	2 U	1.9 U
Delta-BHC	UG/KG	0	0%	300	0	0	178	1.9 U	1.9 U	2 U	2.1 U	2 U	1.9 U
Dieldrin	UG/KG	0	0%	44	0	0	178	3.6 U	3.7 U	3.9 U	4 U	4 U	3.7 U
Endosulfan I	UG/KG	16	1%	900	0	1	178	1.9 U	1.9 U	2 U	2.1 U	2 U	1.9 U
Endosulfan II	UG/KG	0	0%	900	0	0	178	3.6 U	3.7 U	3.9 U	4 U	4 U	3.7 U
Endosulfan sulfate	UG/KG	6.2	1%	1000	0	1	178	3.6 U	3.7 U	3.9 U	4 U	4 U	3.7 U
Endrin	UG/KG	16	2%	100	0	3	178	3.6 U	3.7 U	3.9 U	4 U	4 U	3.7 U
Endrin aldehyde	UG/KG	4.9	1%		0	2	178	3.6 U	3.7 U	3.9 U	4 U	4 U	3.7 U
Endrin ketone	UG/KG	38	2%		0	4	178	3.6 U	3.7 U	3.9 U	4 U	4 U	3.7 U
Gamma-BHC/Lindane	UG/KG	0	0%	60	0	0	178	1.9 U	1.9 U	2 U	2.1 U	2 U	1.9 U
Gamma-Chlordane	UG/KG	24	8%	540	0	14	178	1.9 UJ	1.9 UJ	2 UJ	2.1 UJ	2 UJ	1.9 UJ
Heptachlor	UG/KG	0	0%	100	0	0	178	1.9 U	1.9 U	2 U	2.1 U	2 U	1.9 U
Heptachlor epoxide	UG/KG	3	1%	20	0	2	178	1.9 U	1.9 U	2 U	2.1 U	2 U	1.9 U
Methoxychlor	UG/KG	0	0%		0	0	178	19 U	19 U	20 U	21 U	20 U	19 U
Toxaphene	UG/KG	0	0%		0	0	178	190 U	190 U	200 U	210 U	200 U	190 U
Aroclor-1016	UG/KG	0	0%		0	0	178	36 U	38 U	39 U	41 U	40 U	38 U
Aroclor-1221	UG/KG	0	0%		0	0	178	36 U	38 U	39 U	41 U	40 U	38 U
Aroclor-1232	UG/KG	0	0%		0	0	178	36 U	38 U	39 U	41 U	40 U	38 U
Aroclor-1242	UG/KG	0	0%		0	0	178	36 U	38 U	39 U	41 U	40 U	38 U
Aroclor-1248	UG/KG	0	0%		0	0	178	36 U	38 U	39 U	41 U	40 U	38 U
Aroclor-1254	UG/KG	0	0%	10000	0	0	178	36 U	38 U	39 U	41 U	40 U	38 U
Aroclor-1260	UG/KG	79	1%	10000	0	2	178	36 U	38 U	39 U	41 U	40 U	38 U
Metals													
Aluminum	MG/KG	18300	100%	19300	0	178	178	6080	9340	12000	18300 J	13800	8590
Antimony	MG/KG	424	58%	5.9	5	104	178	0.99 J	1.7 J	1.5 J	2 J	2.1 J	1.3 J
Arsenic	MG/KG	32.2	100%	8.2	7	178	178	2.6	4.5	5.3	5.7 J	7	3.2
Barium	MG/KG	304	100%	300	1	178	178	52.8 J	71 J	117 J	145 J	95.5 J	55.4 J
Beryllium	MG/KG	2.6	99%	1.1	2	176	178	0.31 J	0.48	0.62	0.87	0.79	0.42
Cadmium	MG/KG	3.2	86%	2.3	2	153	178	0.44	0.67	0.64	0.66	0.87	0.54
Calcium	MG/KG	214000	100%	121000	1	178	178	87800	57000	2710	3210 J	3610	78000
Chromium	MG/KG	39.3	100%	29.6	2	178	178	9.6 J	15.3 J	18.4 J	25.7 J	23.4 J	12.9 J
Cobalt	MG/KG	47.8	100%	30	2	178	178	5.1	7.8	10.7	9 J	12.4	6.5
Copper	MG/KG	305	100%	33	19	178	178	19.8	25.1	13	26.5 J	27.1	20.7
Cyanide	MG/KG	0	0%	0.35	0	0	9						
Iron	MG/KG	64000	100%	36500	1	178	178	14400	21800	23600	25700 J	30800	18700
Lead	MG/KG	164	100%	24.8	75	178	178	6.6 J	16.3 J	11.1 J	13.5 J	19 J	7.9 J
Magnesium	MG/KG	30200	100%	21500	3	178	178	15400 J	9760 J	4230 J	5570 J	5400 J	14000 J
Manganese	MG/KG	1290	100%	1060	3	178	178	302 J	536 J	780 J	282 J	358 J	417 J
Mercury	MG/KG	0.95	95%	0.1	37	169	178	0.02 J	0.04 J	0.05	0.04	0.05	0.02 J
Nickel	MG/KG	88.3	100%	49	3	178	178	16.7 J	24.8 J	29 J	32.4 J	37.3 J	22.3 J
Potassium	MG/KG	2290	100%	2380	0	178	178	924	1070	1130	1770 J	1050	1070
Selenium	MG/KG	1.5	9%	2	0	16	178	0.42 U	0.43 U	0.46 U	0.45 U	0.48 U	0.42 U
Silver	MG/KG	2.9	49%	0.75	62	87	178	0.1 U	0.11 U	0.81	0.75	0.75	0.1 U
Sodium	MG/KG	4060	99%	172	86	177	178	182	300	150	1800 J	138	295

**Table A-2A
SURFACE SOIL SAMPLE RESULTS (0-2 ft.)
SEAD-59
SEAD-59 and SEAD-71 Phase II RI Report
Seneca Army Depot Activity**

				SEAD-59	SEAD-59	SEAD-59	SEAD-59	SEAD-59	SEAD-59	SEAD-59	SEAD-59		
				CL-59-01-F08	CL-59-01-F09	CL-59-01-F11	CL-59-01-F12	CL-59-01-F13	CL-59-01-F14	CL-59-01-F13	CL-59-01-F14		
				SOIL	SOIL	SOIL	SOIL	SOIL	SOIL	SOIL	SOIL		
				CL-59-01-F08	CL-59-01-F09	CL-59-01-F11	CL-59-01-F12	CL-59-01-F13	CL-59-01-F14	CL-59-01-F13	CL-59-01-F14		
Facility				SEAD-59	SEAD-59	SEAD-59	SEAD-59	SEAD-59	SEAD-59	SEAD-59	SEAD-59		
Location ID				CL-59-01-F08	CL-59-01-F09	CL-59-01-F11	CL-59-01-F12	CL-59-01-F13	CL-59-01-F14	CL-59-01-F13	CL-59-01-F14		
Maxtrix				SOIL	SOIL	SOIL	SOIL	SOIL	SOIL	SOIL	SOIL		
Sample ID				CL-59-01-F08	CL-59-01-F09	CL-59-01-F11	CL-59-01-F12	CL-59-01-F13	CL-59-01-F14	CL-59-01-F13	CL-59-01-F14		
Sample Depth to Top of Sample ⁽¹⁾				0	0	0	0	0	0	0	0		
Sample Depth to Bottom of Sample ⁽¹⁾				0	0	0	0	0	0	0	0		
Sample Date				5/6/2004	5/6/2004	5/6/2004	5/6/2004	5/6/2004	5/6/2004	5/6/2004	5/6/2004		
QC Code				SA	SA	SA	SA	SA	SA	SA	SA		
Study ID				ENSR IRM	ENSR IRM	ENSR IRM	ENSR IRM	ENSR IRM	ENSR IRM	ENSR IRM	ENSR IRM		
Sample Round				1	1	1	1	1	1	1	1		
Parameter	Units	Maximum Value	Frequency of Detection	NYSDEC TAGM 4046⁽²⁾	Number of Exceedances	Number of Detects	Number of Analyses⁽³⁾	Value (Q)	Value (Q)	Value (Q)	Value (Q)	Value (Q)	Value (Q)
Thallium	MG/KG	1.8	29%	0.7	24	51	178	0.35 J	0.21 U	0.23 U	0.26 J	0.24 U	0.21 U
Vanadium	MG/KG	28.5	100%	150	0	178	178	10.8 J	16.4 J	19.9 J	28.5 J	23.3 J	14.2 J
Zinc	MG/KG	341	100%	110	19	178	178	36 J	50.6 J	94.8 J	76.3 J	62.8 J	42 J

Note(s):

(1) - Historical sample depths are presented (I.e. prior to 2002 TCRA)

(2) - NYSDEC Technical and Administrative Guidance Memorandum (TAGM) HWR-94-4046, Revised January 24, 1994

(3) - Sample/Duplicate pair are presented as individual samples in this table. Statistical information used Sample Duplicate pairs as a single entity and averaged result values were used in risk assessment analysis.

U = compound was not detected

J = the reported value is an estimated concentration

UJ = the compound was not detected; the associated reporting limit is approximate

R = the data was rejected in the data validating process

NJ = compound was "tentatively identified" and the associated numerical value is approximate

Table A-2A
SURFACE SOIL SAMPLE RESULTS (0-2 ft.)
SEAD-59
SEAD-59 and SEAD-71 Phase II RI Report
Seneca Army Depot Activity

Facility	SEAD-59	SEAD-59	SEAD-59	SEAD-59	SEAD-59	SEAD-59							
Location ID	CL-59-01-F15	CL-59-01-F16	CL-59-01-F17	CL-59-01-F18	CL-59-01-F19	CL-59-01-F20							
Maxtrix	SOIL	SOIL	SOIL	SOIL	SOIL	SOIL							
Sample ID	CL-59-01-F15	CL-59-01-F16	CL-59-01-F17	CL-59-01-F18	CL-59-01-F19	CL-59-01-F20							
Sample Depth to Top of Sample ⁽¹⁾	0	0	0	0	0	0							
Sample Depth to Bottom of Sample ⁽¹⁾	0	0	0	0	0	0							
Sample Date	5/6/2004	5/6/2004	5/6/2004	5/6/2004	5/6/2004	5/6/2004							
QC Code	SA	SA	SA	SA	SA	SA							
Study ID	ENSR IRM	ENSR IRM	ENSR IRM	ENSR IRM	ENSR IRM	ENSR IRM							
Sample Round	1	1	1	1	1	1							
Parameter	Units	Maximum Value	Frequency of Detection	NYSDEC TAGM 4046 ⁽²⁾	Number of Exceedances	Number of Detects	Number of Analyses ⁽³⁾	Value (Q)	Value (Q)	Value (Q)	Value (Q)	Value (Q)	Value (Q)
Volatile Organics													
1,1,1-Trichloroethane	UG/KG	0	0%	800	0	0	177	6 U	5 U	5 U	6 U	6 U	6 U
1,1,2,2-Tetrachloroethane	UG/KG	0	0%	600	0	0	169	6 UJ	5 U	5 U	6 U	6 U	6 U
1,1,2-Trichloro-1,2,2-Trifluoroethane	UG/KG	0	0%		0	0	168	6 U	5 U	5 U	6 U	6 U	6 U
1,1,2-Trichloroethane	UG/KG	0	0%		0	0	107	6 U	5 U	5 U	6 U	6 U	6 U
1,1-Dichloroethane	UG/KG	0	0%	200	0	0	177	6 U	5 U	5 U	6 U	6 U	6 U
1,1-Dichloroethene	UG/KG	8	2%	400	0	3	177	6 U	5 U	5 U	6 U	6 U	6 U
1,2,3-Trichloropropane	UG/KG	0	0%		0	0	70						
1,2,4-Trichlorobenzene	UG/KG	0	0%	3400	0	0	161	6 UJ	5 U	5 U	6 U	6 U	6 U
1,2-Dibromo-3-chloropropane	UG/KG	0	0%		0	0	91	6 UJ	5 U	5 U	6 U	6 U	6 U
1,2-Dibromoethane	UG/KG	0	0%		0	0	98	6 U	5 U	5 U	6 U	6 U	6 U
1,2-Dichlorobenzene	UG/KG	0	0%	7900	0	0	161	6 UJ	5 U	5 U	6 U	6 U	6 U
1,2-Dichloroethane	UG/KG	0	0%	100	0	0	177	6 U	5 U	5 U	6 U	6 U	6 U
1,2-Dichloroethene (total)	UG/KG	0	0%		0	0	9						
1,2-Dichloropropane	UG/KG	0	0%		0	0	107	6 U	5 U	5 U	6 U	6 U	6 U
1,3-Dichlorobenzene	UG/KG	0	0%	1600	0	0	161	6 UJ	5 U	5 U	6 U	6 U	6 U
1,3-Dichloropropane	UG/KG	0	0%		0	0	70						
1,4-Dichlorobenzene	UG/KG	0	0%	8500	0	0	161	6 UJ	5 U	5 U	6 U	6 U	6 U
Acetone	UG/KG	550	27%	200	2	47	177	120 NJ	5 U	5 U	6 U	51 NJ	38 NJ
Benzene	UG/KG	3	4%	60	0	7	177	6 U	5 U	5 U	6 U	6 U	6 U
Bromodichloromethane	UG/KG	0	0%		0	0	107	6 U	5 U	5 U	6 U	6 U	6 U
Bromoform	UG/KG	0	0%		0	0	107	6 U	5 U	5 U	6 U	6 U	6 U
Carbon disulfide	UG/KG	4	3%	2700	0	6	177	6 U	5 U	5 U	6 U	6 U	6 U
Carbon tetrachloride	UG/KG	0	0%	600	0	0	177	6 U	5 U	5 U	6 U	6 U	6 U
Chlorobenzene	UG/KG	0	0%	1700	0	0	177	6 U	5 U	5 U	6 U	6 U	6 U
Chlorodibromomethane	UG/KG	0	0%		0	0	177	6 U	5 U	5 U	6 U	6 U	6 U
Chloroethane	UG/KG	0	0%	1900	0	0	177	6 U	5 U	5 U	6 U	6 U	6 U
Chloroform	UG/KG	0	0%	300	0	0	177	6 U	5 U	5 U	6 U	6 U	6 U
Cis-1,2-Dichloroethene	UG/KG	0	0%		0	0	98	6 U	5 U	5 U	6 U	6 U	6 U
Cis-1,3-Dichloropropene	UG/KG	0	0%		0	0	107	6 U	5 U	5 U	6 U	6 U	6 U
Cyclohexane	UG/KG	3	8%		0	8	98	6 U	5 U	5 U	6 U	6 U	6 U
Dichlorodifluoromethane	UG/KG	0	0%		0	0	98	6 U	5 U	5 U	6 U	6 U	6 U
Ethyl benzene	UG/KG	4.6	1%	5500	0	2	177	6 U	5 U	5 U	6 U	6 U	6 U
Isopropylbenzene	UG/KG	0	0%		0	0	98	6 U	5 U	5 U	6 U	6 U	6 U
Meta/Para Xylene	UG/KG	9.4	4%		0	3	70						
Methyl Acetate	UG/KG	2	3%		0	3	98	6 U	5 U	5 U	6 U	6 U	6 U
Methyl Tertbutyl Ether	UG/KG	0	0%		0	0	98	6 U	5 U	5 U	6 U	6 U	6 U
Methyl bromide	UG/KG	0	0%		0	0	107	6 U	5 U	5 U	6 U	6 U	6 U
Methyl butyl ketone	UG/KG	0	0%		0	0	107	6 U	5 U	5 U	6 U	6 U	6 U
Methyl chloride	UG/KG	0	0%		0	0	107	6 U	5 U	5 U	6 U	6 U	6 U
Methyl cyclohexane	UG/KG	5	10%		0	10	98	6 U	5 U	5 U	6 U	6 U	6 U
Methyl ethyl ketone	UG/KG	190	12%	300	0	22	177	25 J	5 U	5 U	6 U	6 U	6 U
Methyl isobutyl ketone	UG/KG	1.9	1%	1000	0	1	177	6 U	5 U	5 U	6 U	6 U	6 U
Methylene chloride	UG/KG	4.9	20%	100	0	36	178	6 UJ	5 UJ	5 UJ	3 UJ	6 UJ	6 UJ
Ortho Xylene	UG/KG	5.05	4%		0	3	70						

Table A-2A
SURFACE SOIL SAMPLE RESULTS (0-2 ft.)
SEAD-59
SEAD-59 and SEAD-71 Phase II RI Report
Seneca Army Depot Activity

Facility	SEAD-59						SEAD-59						
Location ID	CL-59-01-F15		CL-59-01-F16		CL-59-01-F17		CL-59-01-F18		CL-59-01-F19		CL-59-01-F20		
Maxtrix	SOIL						SOIL						
Sample ID	CL-59-01-F15		CL-59-01-F16		CL-59-01-F17		CL-59-01-F18		CL-59-01-F19		CL-59-01-F20		
Sample Depth to Top of Sample ⁽¹⁾	0						0						
Sample Depth to Bottom of Sample ⁽¹⁾	0						0						
Sample Date	5/6/2004		5/6/2004		5/6/2004		5/6/2004		5/6/2004		5/6/2004		
QC Code	SA		SA		SA		SA		SA		SA		
Study ID	ENSR IRM		ENSR IRM		ENSR IRM		ENSR IRM		ENSR IRM		ENSR IRM		
Sample Round	1		1		1		1		1		1		
Parameter	Units	Maximum Value	Frequency of Detection	NYSDEC TAGM 4046 ⁽²⁾	Number of Exceedances	Number of Detects	Number of Analyses ⁽³⁾	Value (Q)	Value (Q)	Value (Q)	Value (Q)	Value (Q)	Value (Q)
Styrene	UG/KG	0	0%		0	0	107	6 U	5 U	5 U	6 U	6 U	6 U
Tetrachloroethene	UG/KG	6.4	3%	1400	0	5	177	6 U	5 U	5 U	6 U	6 U	6 U
Toluene	UG/KG	8	8%	1500	0	14	177	6 U	5 U	5 U	6 U	6 U	6 U
Total BTEX	MG/KG	3.25	67%		0	2	3						
Total Xylenes	UG/KG	3	7%	1200	0	7	102	6 UJ	5 U	5 U	6 U	6 U	6 U
Trans-1,2-Dichloroethene	UG/KG	0	0%	300	0	0	168	6 U	5 U	5 U	6 U	6 U	6 U
Trans-1,3-Dichloropropene	UG/KG	0	0%		0	0	107	6 U	5 U	5 U	6 U	6 U	6 U
Trichloroethene	UG/KG	4.5	5%	700	0	8	177	6 U	5 U	5 U	6 U	6 U	6 U
Trichlorofluoromethane	UG/KG	6	1%		0	1	98	6 U	5 U	5 U	6 U	6 U	6 U
Vinyl chloride	UG/KG	0	0%	200	0	0	177	6 U	5 U	5 U	6 U	6 U	6 U
Semivolatile Organics													
1,1'-Biphenyl	UG/KG	254.5	2%		0	2	99	400 U	360 U	360 U	380 U	390 U	380 U
1,2,4-Trichlorobenzene	UG/KG	0	0%	3400	0	0	9						
1,2-Dichlorobenzene	UG/KG	0	0%	7900	0	0	9						
1,3-Dichlorobenzene	UG/KG	0	0%	1600	0	0	9						
1,4-Dichlorobenzene	UG/KG	0	0%	8500	0	0	9						
2,2'-oxybis(1-Chloropropane)	UG/KG	0	0%		0	0	105	400 U	360 U	360 U	380 U	390 U	380 U
2,4,5-Trichlorophenol	UG/KG	0	0%	100	0	0	178	1000 U	900 U	900 U	960 U	990 U	950 U
2,4,6-Trichlorophenol	UG/KG	0	0%		0	0	178	400 U	360 U	360 U	380 U	390 U	380 U
2,4-Dichlorophenol	UG/KG	0	0%	400	0	0	178	400 U	360 U	360 U	380 U	390 U	380 U
2,4-Dimethylphenol	UG/KG	0	0%		0	0	108	400 U	360 U	360 U	380 U	390 U	380 U
2,4-Dinitrophenol	UG/KG	0	0%	200	0	0	178	1000 U	900 U	900 U	960 U	990 U	950 U
2,4-Dinitrotoluene	UG/KG	0	0%		0	0	178	400 U	360 U	360 U	380 U	390 U	380 U
2,6-Dinitrotoluene	UG/KG	0	0%	1000	0	0	178	400 U	360 U	360 U	380 U	390 U	380 U
2-Chloronaphthalene	UG/KG	0	0%		0	0	108	400 U	360 U	360 U	380 U	390 U	380 U
2-Chlorophenol	UG/KG	0	0%	800	0	0	178	400 U	360 U	360 U	380 U	390 U	380 U
2-Methylnaphthalene	UG/KG	1295	19%	36400	0	34	178	400 U	360 U	360 U	380 U	390 U	380 U
2-Methylphenol	UG/KG	0	0%	100	0	0	178	400 U	360 U	360 U	380 U	390 U	380 U
2-Nitroaniline	UG/KG	0	0%	430	0	0	178	1000 U	900 U	900 U	960 U	990 U	950 U
2-Nitrophenol	UG/KG	0	0%	330	0	0	178	400 U	360 U	360 U	380 U	390 U	380 U
3,3'-Dichlorobenzidine	UG/KG	0	0%		0	0	178	400 U	360 U	360 U	380 U	390 U	380 U
3-Nitroaniline	UG/KG	0	0%	500	0	0	178	1000 U	900 U	900 U	960 U	990 U	950 U
4,6-Dinitro-2-methylphenol	UG/KG	0	0%		0	0	108	1000 U	900 U	900 U	960 U	990 U	950 U
4-Bromophenyl phenyl ether	UG/KG	0	0%		0	0	108	400 U	360 U	360 U	380 U	390 U	380 U
4-Chloro-3-methylphenol	UG/KG	0	0%	240	0	0	178	400 U	360 U	360 U	380 U	390 U	380 U
4-Chloroaniline	UG/KG	1200	1%	220	1	2	178	400 U	360 U	360 U	380 U	390 U	380 U
4-Chlorophenyl phenyl ether	UG/KG	0	0%		0	0	108	400 U	360 U	360 U	380 U	390 U	380 U
4-Methylphenol	UG/KG	150	3%	900	0	5	178	400 U	360 U	360 U	380 U	390 U	380 U
4-Nitroaniline	UG/KG	0	0%		0	0	108	1000 U	900 U	900 U	960 U	990 U	950 U
4-Nitrophenol	UG/KG	0	0%	100	0	0	178	1000 U	900 U	900 U	960 U	990 U	950 U
Acenaphthene	UG/KG	2680	24%	50000	0	42	178	400 U	360 U	360 U	380 U	390 U	380 U
Acenaphthylene	UG/KG	1700	37%	41000	0	66	178	400 U	360 U	360 U	380 U	390 U	380 U
Acetophenone	UG/KG	0	0%		0	0	99	400 U	360 U	360 U	380 U	390 U	380 U
Aniline	UG/KG	0	0%		0	0	70						
Anthracene	UG/KG	4395	43%	50000	0	77	178	400 U	360 U	360 U	380 U	390 U	380 U

Table A-2A
SURFACE SOIL SAMPLE RESULTS (0-2 ft.)
SEAD-59
SEAD-59 and SEAD-71 Phase II RI Report
Seneca Army Depot Activity

Facility	SEAD-59	SEAD-59	SEAD-59	SEAD-59	SEAD-59	SEAD-59							
Location ID	CL-59-01-F15	CL-59-01-F16	CL-59-01-F17	CL-59-01-F18	CL-59-01-F19	CL-59-01-F20							
Maxtrix	SOIL	SOIL	SOIL	SOIL	SOIL	SOIL							
Sample ID	CL-59-01-F15	CL-59-01-F16	CL-59-01-F17	CL-59-01-F18	CL-59-01-F19	CL-59-01-F20							
Sample Depth to Top of Sample ⁽¹⁾	0	0	0	0	0	0							
Sample Depth to Bottom of Sample ⁽¹⁾	0	0	0	0	0	0							
Sample Date	5/6/2004	5/6/2004	5/6/2004	5/6/2004	5/6/2004	5/6/2004							
QC Code	SA	SA	SA	SA	SA	SA							
Study ID	ENSR IRM	ENSR IRM	ENSR IRM	ENSR IRM	ENSR IRM	ENSR IRM							
Sample Round	1	1	1	1	1	1							
Parameter	Units	Maximum Value	Frequency of Detection	NYSDEC TAGM 4046 ⁽²⁾	Number of Exceedances	Number of Detects	Number of Analyses ⁽³⁾	Value (Q)	Value (Q)	Value (Q)	Value (Q)	Value (Q)	Value (Q)
Atrazine	UG/KG	120	1%		0	1	99	400 U	360 U	360 U	380 U	390 U	380 U
Benzaldehyde	UG/KG	50	1%		0	1	99	400 U	360 U	360 U	380 U	390 U	380 U
Benzo(a)anthracene	UG/KG	8900	51%	224	72	90	178	400 U	360 U	360 U	380 U	390 U	380 U
Benzo(a)pyrene	UG/KG	8050	51%	61	84	91	178	400 U	360 U	360 U	380 U	390 U	380 U
Benzo(b)fluoranthene	UG/KG	6800	52%	1100	40	92	178	400 U	360 U	360 U	380 U	390 U	380 U
Benzo(ghi)perylene	UG/KG	5200	46%	50000	0	82	178	400 U	360 U	360 U	380 U	390 U	380 U
Benzo(k)fluoranthene	UG/KG	7350	49%	1100	35	88	178	400 U	360 U	360 U	380 U	390 U	380 U
Benzoic Acid	UG/KG	0	0%	2700	0	0	70						
Bis(2-Chloroethoxy)methane	UG/KG	0	0%		0	0	108	400 U	360 U	360 U	380 U	390 U	380 U
Bis(2-Chloroethyl)ether	UG/KG	0	0%		0	0	108	400 U	360 U	360 U	380 U	390 U	380 U
Bis(2-Chloroisopropyl)ether	UG/KG	0	0%		0	0	3						
Bis(2-Ethylhexyl)phthalate	UG/KG	990	19%	50000	0	34	178	400 U	360 U	360 U	380 U	390 U	380 U
Butylbenzylphthalate	UG/KG	0	0%	50000	0	0	178	400 U	360 U	360 U	380 U	390 U	380 U
Caprolactam	UG/KG	0	0%		0	0	99	400 U	360 U	360 U	380 U	390 U	380 U
Carbazole	UG/KG	755	19%		0	20	108	400 U	360 U	360 U	380 U	390 U	380 U
Chrysene	UG/KG	8900	51%	400	62	91	178	400 U	360 U	360 U	380 U	390 U	380 U
Di-n-butylphthalate	UG/KG	965	2%	8100	0	4	178	400 U	360 U	360 U	380 U	390 U	380 U
Di-n-octylphthalate	UG/KG	0	0%	50000	0	0	178	400 U	360 U	360 U	380 U	390 U	380 U
Dibenz(a,h)anthracene	UG/KG	1665	38%	14	67	68	178	400 U	360 U	360 U	380 U	390 U	380 U
Dibenzofuran	UG/KG	2350	16%	6200	0	28	178	400 U	360 U	360 U	380 U	390 U	380 U
Diethyl phthalate	UG/KG	10	1%	7100	0	1	178	400 U	360 U	360 U	380 U	390 U	380 U
Dimethylphthalate	UG/KG	0	0%	2000	0	0	178	400 U	360 U	360 U	380 U	390 U	380 U
Fluoranthene	UG/KG	23500	54%	50000	0	97	178	400 U	360 U	360 U	380 U	390 U	380 U
Fluorene	UG/KG	2640	28%	50000	0	49	178	400 U	360 U	360 U	380 U	390 U	380 U
Hexachlorobenzene	UG/KG	0	0%	410	0	0	178	400 U	360 U	360 U	380 U	390 U	380 U
Hexachlorobutadiene	UG/KG	0	0%		0	0	178	400 U	360 U	360 U	380 U	390 U	380 U
Hexachlorocyclopentadiene	UG/KG	0	0%		0	0	108	400 U	360 U	360 U	380 U	390 U	380 U
Hexachloroethane	UG/KG	0	0%		0	0	178	400 U	360 U	360 U	380 U	390 U	380 U
Indeno(1,2,3-cd)pyrene	UG/KG	4950	47%	3200	2	84	178	400 U	360 U	360 U	380 U	390 U	380 U
Isophorone	UG/KG	0	0%	4400	0	0	178	400 U	360 U	360 U	380 U	390 U	380 U
N-Nitrosodiphenylamine	UG/KG	100	1%		0	1	108	400 U	360 U	360 U	380 U	390 U	380 U
N-Nitrosodipropylamine	UG/KG	0	0%		0	0	108	400 U	360 U	360 U	380 U	390 U	380 U
Naphthalene	UG/KG	1800	19%	13000	0	34	178	400 U	360 U	360 U	380 U	390 U	380 U
Nitrobenzene	UG/KG	0	0%	200	0	0	178	400 U	360 U	360 U	380 U	390 U	380 U
Pentachlorophenol	UG/KG	0	0%	1000	0	0	178	1000 U	900 U	900 U	950 U	950 U	950 U
Phenanthrene	UG/KG	21300	51%	50000	0	90	178	400 U	360 U	360 U	380 U	390 U	380 U
Phenol	UG/KG	0	0%	30	0	0	178	400 U	360 U	360 U	380 U	390 U	380 U
Pyrene	UG/KG	19200	55%	50000	0	98	178	400 U	360 U	360 U	380 U	390 U	380 U
Pyridine	UG/KG	0	0%		0	0	100	400 U	360 U	360 U	380 U	390 U	380 U
Total Unknown PAHs as SV	MG/KG	25	100%		0	3	3						
Pesticides/PCBs													
4,4'-DDD	UG/KG	740	28%	2900	0	49	178	4 U	3.6 U	3.6 U	3.9 U	3.9 U	3.8 U
4,4'-DDE	UG/KG	2600	37%	2100	1	65	178	4 U	4.4	3.6 U	3.9 U	3.9 U	3.8 U
4,4'-DDT	UG/KG	3700	33%	2100	1	59	178	4 U	3.6 U	3.6 U	3.9 U	3.9 U	3.8 U
Aldrin	UG/KG	1.2	1%	41	0	1	178	2.1 U	1.8 U	1.8 U	2 U	2 U	1.9 U

**Table A-2A
SURFACE SOIL SAMPLE RESULTS (0-2 ft.)
SEAD-59
SEAD-59 and SEAD-71 Phase II RI Report
Seneca Army Depot Activity**

Facility	SEAD-59	SEAD-59	SEAD-59	SEAD-59	SEAD-59	SEAD-59							
Location ID	CL-59-01-F15	CL-59-01-F16	CL-59-01-F17	CL-59-01-F18	CL-59-01-F19	CL-59-01-F20							
Maxtrix	SOIL	SOIL	SOIL	SOIL	SOIL	SOIL							
Sample ID	CL-59-01-F15	CL-59-01-F16	CL-59-01-F17	CL-59-01-F18	CL-59-01-F19	CL-59-01-F20							
Sample Depth to Top of Sample ⁽¹⁾	0	0	0	0	0	0							
Sample Depth to Bottom of Sample ⁽¹⁾	0	0	0	0	0	0							
Sample Date	5/6/2004	5/6/2004	5/6/2004	5/6/2004	5/6/2004	5/6/2004							
QC Code	SA	SA	SA	SA	SA	SA							
Study ID	ENSR IRM	ENSR IRM	ENSR IRM	ENSR IRM	ENSR IRM	ENSR IRM							
Sample Round	1	1	1	1	1	1							
Parameter	Units	Maximum Value	Frequency of Detection	NYSDEC TAGM 4046 ⁽²⁾	Number of Exceedances	Number of Detects	Number of Analyses ⁽³⁾	Value (Q)	Value (Q)	Value (Q)	Value (Q)	Value (Q)	Value (Q)
Alpha-BHC	UG/KG	0	0%	110	0	0	178	2.1 U	1.8 U	1.8 U	2 U	2 U	1.9 U
Alpha-Chlordane	UG/KG	34	4%		0	7	178	2.1 U	1.8 U	1.8 U	2 U	2 U	1.9 U
Beta-BHC	UG/KG	2.4	1%	200	0	1	178	2.1 U	1.8 U	1.8 U	2 U	2 U	1.9 U
Delta-BHC	UG/KG	0	0%	300	0	0	178	2.1 U	1.8 U	1.8 U	2 U	2 U	1.9 U
Dieldrin	UG/KG	0	0%	44	0	0	178	4 U	3.6 U	3.6 U	3.9 U	3.9 U	3.8 U
Endosulfan I	UG/KG	16	1%	900	0	1	178	2.1 U	1.8 U	1.8 U	2 U	2 U	1.9 U
Endosulfan II	UG/KG	0	0%	900	0	0	178	4 U	3.6 U	3.6 U	3.9 U	3.9 U	3.8 U
Endosulfan sulfate	UG/KG	6.2	1%	1000	0	1	178	4 U	3.6 U	3.6 U	3.9 U	3.9 U	3.8 U
Endrin	UG/KG	16	2%	100	0	3	178	4 U	3.6 U	3.6 U	3.9 U	3.9 U	3.8 U
Endrin aldehyde	UG/KG	4.9	1%		0	2	178	4 U	3.6 U	3.6 U	3.9 U	3.9 U	3.8 U
Endrin ketone	UG/KG	38	2%		0	4	178	4 U	3.6 U	3.6 U	3.9 U	3.9 U	3.8 U
Gamma-BHC/Lindane	UG/KG	0	0%	60	0	0	178	2.1 U	1.8 U	1.8 U	2 U	2 U	1.9 U
Gamma-Chlordane	UG/KG	24	8%	540	0	14	178	2.1 UJ	1.8 UJ	1.8 UJ	2 UJ	2 UJ	1.9 UJ
Heptachlor	UG/KG	0	0%	100	0	0	178	2.1 U	1.8 U	1.8 U	2 U	2 U	1.9 U
Heptachlor epoxide	UG/KG	3	1%	20	0	2	178	2.1 U	1.8 U	1.8 U	2 U	2 U	1.9 U
Methoxychlor	UG/KG	0	0%		0	0	178	21 U	18 U	18 U	20 U	20 U	19 U
Toxaphene	UG/KG	0	0%		0	0	178	210 U	180 U	180 U	200 U	200 U	190 U
Aroclor-1016	UG/KG	0	0%		0	0	178	41 U	36 U	36 U	39 U	39 U	38 U
Aroclor-1221	UG/KG	0	0%		0	0	178	41 U	36 U	36 U	39 U	39 U	38 U
Aroclor-1232	UG/KG	0	0%		0	0	178	41 U	36 U	36 U	39 U	39 U	38 U
Aroclor-1242	UG/KG	0	0%		0	0	178	41 U	36 U	36 U	39 U	39 U	38 U
Aroclor-1248	UG/KG	0	0%		0	0	178	41 U	36 U	36 U	39 U	39 U	38 U
Aroclor-1254	UG/KG	0	0%	10000	0	0	178	41 U	36 U	36 U	39 U	39 U	38 U
Aroclor-1260	UG/KG	79	1%	10000	0	2	178	41 U	36 U	36 U	39 U	39 U	38 U
Metals													
Aluminum	MG/KG	18300	100%	19300	0	178	178	14700	8130 J	5290 J	13200 J	16600 J	12700 J
Antimony	MG/KG	424	58%	5.9	5	104	178	1.6 J	1.4 J	0.65 J	1.5 J	1.7 J	1.7 J
Arsenic	MG/KG	32.2	100%	8.2	7	178	178	5.9	3.6 J	2.8 J	7.8 J	7 J	8 J
Barium	MG/KG	304	100%	300	1	178	178	164 J	63.2 J	45.6 J	96.4 J	161 J	145 J
Beryllium	MG/KG	2.6	99%	1.1	2	176	178	0.81	0.38	0.22 J	0.69	0.66	0.63
Cadmium	MG/KG	3.2	86%	2.3	2	153	178	0.81	0.42	0.25 J	0.78	0.76	0.69
Calcium	MG/KG	214000	100%	121000	1	178	178	3020	92900 J	83400 J	4260 J	1350 J	1840 J
Chromium	MG/KG	39.3	100%	29.6	2	178	178	20.5 J	12.4 J	7.4 J	19.7 J	23.4 J	20.2 J
Cobalt	MG/KG	47.8	100%	30	2	178	178	9.6	6.9 J	3.8 J	12.3 J	10.8 J	11.1 J
Copper	MG/KG	305	100%	33	19	178	178	24.9	17.1 J	13.4 J	23.5 J	32.3 J	20.6 J
Cyanide	MG/KG	0	0%	0.35	0	0	9						
Iron	MG/KG	64000	100%	36500	1	178	178	26800	13100 J	9210 J	25300 J	26300 J	24100 J
Lead	MG/KG	164	100%	24.8	75	178	178	15.3 J	6 J	4.1 J	13.5 J	14.9 J	14.1 J
Magnesium	MG/KG	30200	100%	21500	3	178	178	3860 J	16100 J	24700 J	4580 J	5260 J	4850 J
Manganese	MG/KG	1290	100%	1060	3	178	178	809 J	330 J	301 J	806 J	416 J	914 J
Mercury	MG/KG	0.95	95%	0.1	37	169	178	0.09	0.02 U	0.02 U	0.03 J	0.05	0.04
Nickel	MG/KG	88.3	100%	49	3	178	178	25.8 J	19.6 J	9 J	31.9 J	28.5 J	32.7 J
Potassium	MG/KG	2290	100%	2380	0	178	178	1170	1160 J	1320 J	1120 J	1560 J	1250 J
Selenium	MG/KG	1.5	9%	2	0	16	178	0.46 U	0.4 U	0.38 U	0.43 U	0.42 U	0.45 U
Silver	MG/KG	2.9	49%	0.75	62	87	178	0.76	0.1 U	0.1 U	0.75	0.85	0.82
Sodium	MG/KG	4060	99%	172	86	177	178	1130	171 J	808 J	899	3010 J	2380 J

**Table A-2A
SURFACE SOIL SAMPLE RESULTS (0-2 ft.)
SEAD-59
SEAD-59 and SEAD-71 Phase II RI Report
Seneca Army Depot Activity**

				SEAD-59	SEAD-59	SEAD-59	SEAD-59	SEAD-59	SEAD-59	SEAD-59	SEAD-59		
				CL-59-01-F15	CL-59-01-F16	CL-59-01-F17	CL-59-01-F18	CL-59-01-F19	CL-59-01-F20	CL-59-01-F19	CL-59-01-F20		
				SOIL	SOIL	SOIL	SOIL	SOIL	SOIL	SOIL	SOIL		
				CL-59-01-F15	CL-59-01-F16	CL-59-01-F17	CL-59-01-F18	CL-59-01-F19	CL-59-01-F20	CL-59-01-F19	CL-59-01-F20		
				0	0	0	0	0	0	0	0		
				0	0	0	0	0	0	0	0		
				5/6/2004	5/6/2004	5/6/2004	5/6/2004	5/6/2004	5/6/2004	5/6/2004	5/6/2004		
				SA	SA	SA	SA	SA	SA	SA	SA		
				ENSR IRM	ENSR IRM	ENSR IRM	ENSR IRM	ENSR IRM	ENSR IRM	ENSR IRM	ENSR IRM		
				1	1	1	1	1	1	1	1		
Parameter	Units	Maximum Value	Frequency of Detection	NYSDEC TAGM 4046⁽²⁾	Number of Exceedances	Number of Detects	Number of Analyses⁽³⁾	Value (Q)	Value (Q)	Value (Q)	Value (Q)	Value (Q)	Value (Q)
Thallium	MG/KG	1.8	29%	0.7	24	51	178	0.23 U	0.2 U	0.4 J	0.21 U	0.21 U	0.22 U
Vanadium	MG/KG	28.5	100%	150	0	178	178	24.5 J	13.3 J	10.3 J	23.9 J	27.8 J	23.1 J
Zinc	MG/KG	341	100%	110	19	178	178	71.2 J	35.5 J	19.6 J	65.8 J	61 J	67.2 J

Note(s):

(1) - Historical sample depths are presented (I.e. prior to 2002 TCRA)

(2) - NYSDEC Technical and Administrative Guidance Memorandum (TAGM) HWR-94-4046, Revised January 24, 1994

(3) - Sample/Duplicate pair are presented as individual samples in this table. Statistical information used Sample Duplicate pairs as a single entity and averaged result values were used in risk assessment analysis.

U = compound was not detected

J = the reported value is an estimated concentration

UJ = the compound was not detected; the associated reporting limit is approximate

R = the data was rejected in the data validating process

NJ = compound was "tentatively identified" and the associated numerical value is approximate

**Table A-2A
SURFACE SOIL SAMPLE RESULTS (0-2 ft.)
SEAD-59
SEAD-59 and SEAD-71 Phase II RI Report
Seneca Army Depot Activity**

Facility	SEAD-59	SEAD-59	SEAD-59	SEAD-59	SEAD-59	SEAD-59							
Location ID	CL-59-01-F21	CL-59-01-F22	CL-59-01-F24	CL-59-01-F25	CL-59-01-F26	CL-59-01-WE1							
Maxtrix	SOIL	SOIL	SOIL	SOIL	SOIL	SOIL							
Sample ID	CL-59-01-F21	CL-59-01-F22	CL-59-01-F24	CL-59-01-F25	CL-59-01-F26	CL-59-01-WE1							
Sample Depth to Top of Sample ⁽¹⁾	0	0	0	0	0	0							
Sample Depth to Bottom of Sample ⁽¹⁾	0	0	0	0	0	0							
Sample Date	5/6/2004	5/6/2004	5/6/2004	5/6/2004	5/6/2004	5/6/2004							
QC Code	SA	SA	SA	SA	SA	SA							
Study ID	ENSR IRM	ENSR IRM	ENSR IRM	ENSR IRM	ENSR IRM	ENSR IRM							
Sample Round	1	1	1	1	1	1							
Parameter	Units	Maximum Value	Frequency of Detection	NYSDEC TAGM 4046 ⁽²⁾	Number of Exceedances	Number of Detects	Number of Analyses ⁽³⁾	Value (Q)	Value (Q)	Value (Q)	Value (Q)	Value (Q)	Value (Q)
Volatile Organics													
1,1,1-Trichloroethane	UG/KG	0	0%	800	0	0	177	6 U	6 U	6 U	5 U	6 U	5 U
1,1,2,2-Tetrachloroethane	UG/KG	0	0%	600	0	0	169	6 U	6 U	6 UJ	5 U	6 U	5 U
1,1,2-Trichloro-1,2,2-Trifluoroethane	UG/KG	0	0%		0	0	168	6 U	6 U	6 UJ	5 U	6 U	5 U
1,1,2-Trichloroethane	UG/KG	0	0%		0	0	107	6 U	6 U	6 U	5 U	6 U	5 U
1,1-Dichloroethane	UG/KG	0	0%	200	0	0	177	6 U	6 U	6 U	5 U	6 U	5 U
1,1-Dichloroethene	UG/KG	8	2%	400	0	3	177	6 U	6 U	6 U	5 U	6 U	5 U
1,2,3-Trichloropropane	UG/KG	0	0%		0	0	70						
1,2,4-Trichlorobenzene	UG/KG	0	0%	3400	0	0	161	6 U	6 U	6 U	5 U	6 U	5 U
1,2-Dibromo-3-chloropropane	UG/KG	0	0%		0	0	91	6 U	6 U	6 U	5 U	6 U	5 U
1,2-Dibromoethane	UG/KG	0	0%		0	0	98	6 U	6 U	6 U	5 U	6 U	5 U
1,2-Dichlorobenzene	UG/KG	0	0%	7900	0	0	161	6 U	6 U	6 U	5 U	6 U	5 U
1,2-Dichloroethane	UG/KG	0	0%	100	0	0	177	6 U	6 U	6 U	5 U	6 U	5 U
1,2-Dichloroethene (total)	UG/KG	0	0%		0	0	9						
1,2-Dichloropropane	UG/KG	0	0%		0	0	107	6 U	6 U	6 U	5 U	6 U	5 U
1,3-Dichlorobenzene	UG/KG	0	0%	1600	0	0	161	6 U	6 U	6 U	5 U	6 U	5 U
1,3-Dichloropropane	UG/KG	0	0%		0	0	70						
1,4-Dichlorobenzene	UG/KG	0	0%	8500	0	0	161	6 U	6 U	6 U	5 U	6 U	5 U
Acetone	UG/KG	550	27%	200	2	47	177	5 NJ	45 NJ	66 NJ	5 UJ	12 NJ	49 NJ
Benzene	UG/KG	3	4%	60		7	177	6 U	6 U	6 U	5 U	6 U	5 U
Bromodichloromethane	UG/KG	0	0%		0	0	107	6 U	6 U	6 U	5 U	6 U	5 U
Bromoform	UG/KG	0	0%		0	0	107	6 U	6 U	6 U	5 U	6 U	5 U
Carbon disulfide	UG/KG	4	3%	2700	0	6	177	6 U	6 U	6 U	5 U	6 U	5 U
Carbon tetrachloride	UG/KG	0	0%	600	0	0	177	6 U	6 U	6 U	5 U	6 U	5 U
Chlorobenzene	UG/KG	0	0%	1700	0	0	177	6 U	6 U	6 U	5 U	6 U	5 U
Chlorodibromomethane	UG/KG	0	0%		0	0	177	6 U	6 U	6 U	5 U	6 U	5 U
Chloroethane	UG/KG	0	0%	1900	0	0	177	6 U	6 U	6 U	5 U	6 U	5 U
Chloroform	UG/KG	0	0%	300	0	0	177	6 U	6 U	6 U	5 U	6 U	5 U
Cis-1,2-Dichloroethene	UG/KG	0	0%		0	0	98	6 U	6 U	6 U	5 U	6 U	5 U
Cis-1,3-Dichloropropene	UG/KG	0	0%		0	0	107	6 U	6 U	6 U	5 U	6 U	5 U
Cyclohexane	UG/KG	3	8%		0	8	98	6 U	6 U	6 U	5 U	6 U	5 U
Dichlorodifluoromethane	UG/KG	0	0%		0	0	98	6 U	6 U	6 U	5 U	6 U	5 U
Ethyl benzene	UG/KG	4.6	1%	5500	0	2	177	6 U	6 U	6 U	5 U	6 U	5 U
Isopropylbenzene	UG/KG	0	0%		0	0	98	6 U	6 U	6 U	5 U	6 U	5 U
Meta/Para Xylene	UG/KG	9.4	4%		0	3	70						
Methyl Acetate	UG/KG	2	3%		0	3	98	6 U	6 U	6 UJ	5 U	6 U	5 U
Methyl Tertbutyl Ether	UG/KG	0	0%		0	0	98	6 UJ	6 UJ	6 U	5 UJ	6 UJ	5 U
Methyl bromide	UG/KG	0	0%		0	0	107	6 UJ	6 UJ	6 UJ	5 UJ	6 UJ	5 U
Methyl butyl ketone	UG/KG	0	0%		0	0	107	6 UJ	6 UJ	6 U	5 UJ	6 UJ	5 U
Methyl chloride	UG/KG	0	0%		0	0	107	6 U	6 U	6 U	5 U	6 U	5 U
Methyl cyclohexane	UG/KG	5	10%		0	10	98	6 U	6 U	6 U	5 U	6 U	5 U
Methyl ethyl ketone	UG/KG	190	12%	300	0	22	177	6 U	11 J	12 J	5 U	6 U	4 J
Methyl isobutyl ketone	UG/KG	1.9	1%	1000	0	1	177	6 UJ	6 UJ	6 UJ	5 UJ	6 UJ	5 U
Methylene chloride	UG/KG	4.9	20%	100	0	36	178	6 UJ	6 UJ	6 U	5 UJ	6 UJ	5 U
Ortho Xylene	UG/KG	5.05	4%		0	3	70						

Table A-2A
SURFACE SOIL SAMPLE RESULTS (0-2 ft.)
SEAD-59
SEAD-59 and SEAD-71 Phase II RI Report
Seneca Army Depot Activity

Facility	SEAD-59						SEAD-59	SEAD-59	SEAD-59	SEAD-59	SEAD-59	SEAD-59	
Location ID	CL-59-01-F21						CL-59-01-F22	CL-59-01-F24	CL-59-01-F25	CL-59-01-F26	CL-59-01-F26	CL-59-01-F26	
Maxtrix	SOIL						SOIL	SOIL	SOIL	SOIL	SOIL	SOIL	
Sample ID	CL-59-01-F21						CL-59-01-F22	CL-59-01-F24	CL-59-01-F25	CL-59-01-F26	CL-59-01-F26	CL-59-01-F26	
Sample Depth to Top of Sample ⁽¹⁾	0						0	0	0	0	0	0	
Sample Depth to Bottom of Sample ⁽¹⁾	0						0	0	0	0	0	0	
Sample Date	5/6/2004						5/6/2004	5/6/2004	5/6/2004	5/6/2004	5/6/2004	5/6/2004	
QC Code	SA						SA	SA	SA	SA	SA	SA	
Study ID	ENSR IRM						ENSR IRM	ENSR IRM	ENSR IRM	ENSR IRM	ENSR IRM	ENSR IRM	
Sample Round	1						1	1	1	1	1	1	
Parameter	Units	Maximum Value	Frequency of Detection	NYSDEC TAGM 4046 ⁽²⁾	Number of Exceedances	Number of Detects	Number of Analyses ⁽³⁾	Value (Q)	Value (Q)	Value (Q)	Value (Q)	Value (Q)	Value (Q)
Styrene	UG/KG	0	0%		0	0	107	6 U	6 U	6 U	5 U	6 U	5 U
Tetrachloroethene	UG/KG	6.4	3%	1400	0	5	177	6 U	6 U	2 J	5 U	6 U	5 U
Toluene	UG/KG	8	8%	1500	0	14	177	6 U	6 U	6 U	5 U	6 U	5 U
Total BTEX	MG/KG	3.25	67%		0	2	3						
Total Xylenes	UG/KG	3	7%	1200	0	7	102	6 U	6 U	6 U	5 U	6 U	5 U
Trans-1,2-Dichloroethene	UG/KG	0	0%	300	0	0	168	6 U	6 U	6 U	5 U	6 U	5 U
Trans-1,3-Dichloropropene	UG/KG	0	0%		0	0	107	6 U	6 U	6 U	5 U	6 U	5 U
Trichloroethene	UG/KG	4.5	5%	700	0	8	177	6 U	6 U	6 U	5 U	6 U	5 U
Trichlorofluoromethane	UG/KG	6	1%		0	1	98	6 U	6 U	6 UJ	5 U	6 U	5 U
Vinyl chloride	UG/KG	0	0%	200	0	0	177	6 U	6 U	6 U	5 U	6 U	5 U
Semivolatile Organics													
1,1'-Biphenyl	UG/KG	254.5	2%		0	2	99	390 U	390 U	390 U	370 U	380 U	430 U
1,2,4-Trichlorobenzene	UG/KG	0	0%	3400	0	0	9						
1,2-Dichlorobenzene	UG/KG	0	0%	7900	0	0	9						
1,3-Dichlorobenzene	UG/KG	0	0%	1600	0	0	9						
1,4-Dichlorobenzene	UG/KG	0	0%	8500	0	0	9						
2,2'-oxybis(1-Chloropropane)	UG/KG	0	0%		0	0	105	390 U	390 U	390 U	370 U	380 U	430 U
2,4,5-Trichlorophenol	UG/KG	0	0%	100	0	0	178	970 U	980 U	990 U	930 U	950 U	1100 U
2,4,6-Trichlorophenol	UG/KG	0	0%		0	0	178	390 U	390 U	390 U	370 U	380 U	430 U
2,4-Dichlorophenol	UG/KG	0	0%	400	0	0	178	390 U	390 U	390 U	370 U	380 U	430 U
2,4-Dimethylphenol	UG/KG	0	0%		0	0	108	390 U	390 U	390 U	370 U	380 U	430 U
2,4-Dinitrophenol	UG/KG	0	0%	200	0	0	178	970 U	980 U	990 U	930 U	950 U	1100 U
2,4-Dinitrotoluene	UG/KG	0	0%		0	0	178	390 U	390 U	390 U	370 U	380 U	430 U
2,6-Dinitrotoluene	UG/KG	0	0%	1000	0	0	178	390 U	390 U	390 U	370 U	380 U	430 U
2-Chloronaphthalene	UG/KG	0	0%		0	0	108	390 U	390 U	390 U	370 U	380 U	430 U
2-Chlorophenol	UG/KG	0	0%	800	0	0	178	390 U	390 U	390 U	370 U	380 U	430 U
2-Methylnaphthalene	UG/KG	1295	19%	36400	0	34	178	390 U	390 U	390 U	370 U	380 U	430 U
2-Methylphenol	UG/KG	0	0%	100	0	0	178	390 U	390 U	390 U	370 U	380 U	430 U
2-Nitroaniline	UG/KG	0	0%	430	0	0	178	970 U	980 U	990 U	930 U	950 U	1100 U
2-Nitrophenol	UG/KG	0	0%	330	0	0	178	390 U	390 U	390 U	370 U	380 U	430 U
3,3'-Dichlorobenzidine	UG/KG	0	0%		0	0	178	390 U	390 U	390 U	370 U	380 U	430 U
3-Nitroaniline	UG/KG	0	0%	500	0	0	178	970 U	980 U	990 U	930 U	950 U	1100 U
4,6-Dinitro-2-methylphenol	UG/KG	0	0%		0	0	108	970 U	980 U	990 U	930 U	950 U	1100 U
4-Bromophenyl phenyl ether	UG/KG	0	0%		0	0	108	390 U	390 U	390 U	370 U	380 U	430 U
4-Chloro-3-methylphenol	UG/KG	0	0%	240	0	0	178	390 U	390 U	390 U	370 U	380 U	430 U
4-Chloroaniline	UG/KG	1200	1%	220	1	2	178	390 U	390 U	390 U	370 U	380 U	430 U
4-Chlorophenyl phenyl ether	UG/KG	0	0%		0	0	108	390 U	390 U	390 U	370 U	380 U	430 U
4-Methylphenol	UG/KG	150	3%	900	0	5	178	390 U	390 U	390 U	370 U	380 U	430 U
4-Nitroaniline	UG/KG	0	0%		0	0	108	970 U	980 U	990 U	930 U	950 U	1100 U
4-Nitrophenol	UG/KG	0	0%	100	0	0	178	970 U	980 U	990 U	930 U	950 U	1100 U
Acenaphthene	UG/KG	2680	24%	50000	0	42	178	390 U	390 U	390 U	370 U	380 U	430 U
Acenaphthylene	UG/KG	1700	37%	41000	0	66	178	390 U	390 U	390 U	370 U	380 U	430 U
Acetophenone	UG/KG	0	0%		0	0	99	390 U	390 U	390 U	370 U	380 U	430 U
Aniline	UG/KG	0	0%		0	0	70						
Anthracene	UG/KG	4395	43%	50000	0	77	178	390 U	390 U	390 U	370 U	380 U	430 U

Table A-2A
SURFACE SOIL SAMPLE RESULTS (0-2 ft.)
SEAD-59
SEAD-59 and SEAD-71 Phase II RI Report
Seneca Army Depot Activity

Facility	SEAD-59	SEAD-59	SEAD-59	SEAD-59	SEAD-59	SEAD-59							
Location ID	CL-59-01-F21	CL-59-01-F22	CL-59-01-F24	CL-59-01-F25	CL-59-01-F26	CL-59-01-F26							
Maxtrix	SOIL	SOIL	SOIL	SOIL	SOIL	SOIL							
Sample ID	CL-59-01-F21	CL-59-01-F22	CL-59-01-F24	CL-59-01-F25	CL-59-01-F26	CL-59-01-F26							
Sample Depth to Top of Sample ⁽¹⁾	0	0	0	0	0	0							
Sample Depth to Bottom of Sample ⁽¹⁾	0	0	0	0	0	0							
Sample Date	5/6/2004	5/6/2004	5/6/2004	5/6/2004	5/6/2004	5/6/2004							
QC Code	SA	SA	SA	SA	SA	SA							
Study ID	ENSR IRM	ENSR IRM	ENSR IRM	ENSR IRM	ENSR IRM	ENSR IRM							
Sample Round	1	1	1	1	1	1							
Parameter	Units	Maximum Value	Frequency of Detection	NYSDEC TAGM 4046 ⁽²⁾	Number of Exceedances	Number of Detects	Number of Analyses ⁽³⁾	Value (Q)	Value (Q)	Value (Q)	Value (Q)	Value (Q)	Value (Q)
Atrazine	UG/KG	120	1%		0	1	99	390 U	390 U	390 U	370 U	380 U	430 U
Benzaldehyde	UG/KG	50	1%		0	1	99	390 U	390 U	390 U	370 U	380 U	430 U
Benzo(a)anthracene	UG/KG	8900	51%	224	72	90	178	390 U	390 U	390 U	370 U	380 U	430 U
Benzo(a)pyrene	UG/KG	8050	51%	61	84	91	178	390 U	390 U	390 U	60 J	380 U	430 U
Benzo(b)fluoranthene	UG/KG	6800	52%	1100	40	92	178	390 U	390 U	390 U	68 J	380 U	430 U
Benzo(ghi)perylene	UG/KG	5200	46%	50000	0	82	178	390 U	390 U	390 U	370 U	380 U	430 U
Benzo(k)fluoranthene	UG/KG	7350	49%	1100	35	88	178	390 U	390 U	390 U	25 J	380 U	430 U
Benzoic Acid	UG/KG	0	0%	2700	0	0	70						
Bis(2-Chloroethoxy)methane	UG/KG	0	0%		0	0	108	390 U	390 U	390 U	370 U	380 U	430 U
Bis(2-Chloroethyl)ether	UG/KG	0	0%		0	0	108	390 U	390 U	390 U	370 U	380 U	430 U
Bis(2-Chloroisopropyl)ether	UG/KG	0	0%		0	0	3						
Bis(2-Ethylhexyl)phthalate	UG/KG	990	19%	50000	0	34	178	390 U	390 U	390 U	370 U	380 U	430 U
Butylbenzylphthalate	UG/KG	0	0%	50000	0	0	178	390 U	390 U	390 U	370 U	380 U	430 U
Caprolactam	UG/KG	0	0%		0	0	99	390 U	390 U	390 U	370 U	380 U	430 U
Carbazole	UG/KG	755	19%		0	20	108	390 U	390 U	390 U	370 U	380 U	430 U
Chrysene	UG/KG	8900	51%	400	62	91	178	390 U	390 U	390 U	370 U	380 U	430 U
Di-n-butylphthalate	UG/KG	965	2%	8100	0	4	178	390 U	390 U	390 U	370 U	380 U	430 U
Di-n-octylphthalate	UG/KG	0	0%	50000	0	0	178	390 U	390 U	390 U	370 U	380 U	430 U
Dibenz(a,h)anthracene	UG/KG	1665	38%	14	67	68	178	390 U	390 U	390 U	370 U	380 U	430 U
Dibenzofuran	UG/KG	2350	16%	6200	0	28	178	390 U	390 U	390 U	370 U	380 U	430 U
Diethyl phthalate	UG/KG	10	1%	7100	0	1	178	390 U	390 U	390 U	370 U	380 U	430 U
Dimethylphthalate	UG/KG	0	0%	2000	0	0	178	390 U	390 U	390 U	370 U	380 U	430 U
Fluoranthene	UG/KG	23500	54%	50000	0	97	178	390 U	390 U	390 U	54 J	380 U	430 U
Fluorene	UG/KG	2640	28%	50000	0	49	178	390 U	390 U	390 U	370 U	380 U	430 U
Hexachlorobenzene	UG/KG	0	0%	410	0	0	178	390 U	390 U	390 U	370 U	380 U	430 U
Hexachlorobutadiene	UG/KG	0	0%		0	0	178	390 U	390 U	390 U	370 U	380 U	430 U
Hexachlorocyclopentadiene	UG/KG	0	0%		0	0	108	390 U	390 U	390 U	370 U	380 U	430 U
Hexachloroethane	UG/KG	0	0%		0	0	178	390 U	390 U	390 U	370 U	380 U	430 U
Indeno(1,2,3-cd)pyrene	UG/KG	4950	47%	3200	2	84	178	390 U	390 U	390 U	370 U	380 U	430 U
Isophorone	UG/KG	0	0%	4400	0	0	178	390 U	390 U	390 U	370 U	380 U	430 U
N-Nitrosodiphenylamine	UG/KG	100	1%		0	1	108	390 U	390 U	390 U	370 U	380 U	430 U
N-Nitrosodipropylamine	UG/KG	0	0%		0	0	108	390 U	390 U	390 U	370 U	380 U	430 U
Naphthalene	UG/KG	1800	19%	13000	0	34	178	390 U	390 U	390 U	370 U	380 U	430 U
Nitrobenzene	UG/KG	0	0%	200	0	0	178	390 U	390 U	390 U	370 U	380 U	430 U
Pentachlorophenol	UG/KG	0	0%	1000	0	0	178	970 U	990 U	990 U	930 U	950 U	1100 U
Phenanthrene	UG/KG	21300	51%	50000	0	90	178	390 U	390 U	390 U	370 U	380 U	430 U
Phenol	UG/KG	0	0%	30	0	0	178	390 U	390 U	390 U	370 U	380 U	430 U
Pyrene	UG/KG	19200	55%	50000	0	98	178	390 U	390 U	390 U	75 J	380 U	430 U
Pyridine	UG/KG	0	0%		0	0	100	390 U	390 U	390 U	370 U	380 U	
Total Unknown PAHs as SV	MG/KG	25	100%		0	3	3						
Pesticides/PCBs													
4,4'-DDD	UG/KG	740	28%	2900	0	49	178	3.8 U	3.9 U	3.9 U	3.7 U	3.9 U	4.4 U
4,4'-DDE	UG/KG	2600	37%	2100	1	65	178	3.8 U	3.9 U	3.9 U	3.7 U	3.9 U	4.4 U
4,4'-DDT	UG/KG	3700	33%	2100	1	59	178	3.8 U	3.9 U	3.9 U	3.7 U	3.9 U	4.4 U
Aldrin	UG/KG	1.2	1%	41	0	1	178	2 U	2 U	2 U	1.9 U	2 U	2.2 U

Table A-2A
SURFACE SOIL SAMPLE RESULTS (0-2 ft.)
SEAD-59
SEAD-59 and SEAD-71 Phase II RI Report
Seneca Army Depot Activity

Facility	SEAD-59						SEAD-59						
Location ID	CL-59-01-F21		CL-59-01-F22		CL-59-01-F24		CL-59-01-F25		CL-59-01-F26		CL-59-01-F26		
Maxtrix	SOIL						SOIL						
Sample ID	CL-59-01-F21		CL-59-01-F22		CL-59-01-F24		CL-59-01-F25		CL-59-01-F26		CL-59-01-F26		
Sample Depth to Top of Sample ⁽¹⁾	0						0						
Sample Depth to Bottom of Sample ⁽¹⁾	0						0						
Sample Date	5/6/2004		5/6/2004		5/6/2004		5/6/2004		5/6/2004		5/6/2004		
QC Code	SA		SA		SA		SA		SA		SA		
Study ID	ENSR IRM		ENSR IRM		ENSR IRM		ENSR IRM		ENSR IRM		ENSR IRM		
Sample Round	1		1		1		1		1		1		
Parameter	Units	Maximum Value	Frequency of Detection	NYSDEC TAGM 4046 ⁽²⁾	Number of Exceedances	Number of Detects	Number of Analyses ⁽³⁾	Value (Q)	Value (Q)	Value (Q)	Value (Q)	Value (Q)	Value (Q)
Alpha-BHC	UG/KG	0	0%	110	0	0	178	2 U	2 U	2 U	1.9 U	2 U	2.2 U
Alpha-Chlordane	UG/KG	34	4%		0	7	178	2 UJ	2 UJ	2 UJ	1.9 UJ	2 UJ	2.2 U
Beta-BHC	UG/KG	2.4	1%	200	0	1	178	2 U	2 U	2 U	1.9 U	2 U	2.2 U
Delta-BHC	UG/KG	0	0%	300	0	0	178	2 UJ	2 UJ	2 UJ	1.9 UJ	2 UJ	2.2 U
Dieldrin	UG/KG	0	0%	44	0	0	178	3.8 U	3.9 U	3.9 U	3.7 U	3.9 U	4.4 U
Endosulfan I	UG/KG	16	1%	900	0	1	178	2 U	2 U	2 U	1.9 U	2 U	2.2 U
Endosulfan II	UG/KG	0	0%	900	0	0	178	3.8 U	3.9 U	3.9 U	3.7 U	3.9 U	4.4 U
Endosulfan sulfate	UG/KG	6.2	1%	1000	0	1	178	3.8 U	3.9 U	3.9 U	3.7 U	3.9 U	4.4 U
Endrin	UG/KG	16	2%	100	0	3	178	3.8 U	3.9 U	3.9 U	3.7 U	3.9 U	4.4 U
Endrin aldehyde	UG/KG	4.9	1%		0	2	178	3.8 U	3.9 U	3.9 U	3.7 U	3.9 U	4.4 U
Endrin ketone	UG/KG	38	2%		0	4	178	3.8 U	3.9 U	3.9 U	3.7 U	3.9 U	4.4 U
Gamma-BHC/Lindane	UG/KG	0	0%	60	0	0	178	2 U	2 U	2 U	1.9 U	2 U	2.2 U
Gamma-Chlordane	UG/KG	24	8%	540	0	14	178	2 UJ	2 UJ	2 UJ	1.9 UJ	2 UJ	2.2 U
Heptachlor	UG/KG	0	0%	100	0	0	178	2 U	2 U	2 U	1.9 U	2 U	2.2 U
Heptachlor epoxide	UG/KG	3	1%	20	0	2	178	2 U	2 U	2 U	1.9 U	2 U	2.2 U
Methoxychlor	UG/KG	0	0%		0	0	178	20 U	20 U	20 U	19 U	20 U	22 U
Toxaphene	UG/KG	0	0%		0	0	178	200 U	200 U	200 U	190 U	200 U	220 U
Aroclor-1016	UG/KG	0	0%		0	0	178	39 U	40 U	40 U	37 U	39 U	44 U
Aroclor-1221	UG/KG	0	0%		0	0	178	39 U	40 U	40 U	37 U	39 U	44 U
Aroclor-1232	UG/KG	0	0%		0	0	178	39 U	40 U	40 U	37 U	39 U	44 U
Aroclor-1242	UG/KG	0	0%		0	0	178	39 U	40 U	40 U	37 U	39 U	44 U
Aroclor-1248	UG/KG	0	0%		0	0	178	39 U	40 U	40 U	37 U	39 U	44 U
Aroclor-1254	UG/KG	0	0%	10000	0	0	178	39 U	40 U	40 U	37 U	39 U	44 U
Aroclor-1260	UG/KG	79	1%	10000	0	2	178	39 U	40 U	40 U	37 U	39 U	44 U
Metals													
Aluminum	MG/KG	18300	100%	19300	0	178	178	13200 J	11900 J	12400 J	8320 J	13200 J	14400 J
Antimony	MG/KG	424	58%	5.9	5	104	178	1.4 J	1.6 J	1.7 J	1.4 J	2.8 J	1.9 J
Arsenic	MG/KG	32.2	100%	8.2	7	178	178	5.8 J	7.1 J	5.5 J	2.3 J	5.5 J	6 J
Barium	MG/KG	304	100%	300	1	178	178	143 J	116 J	82.5 J	92.5 J	119 J	148 J
Beryllium	MG/KG	2.6	99%	1.1	2	176	178	0.77	0.69	0.72	0.4	0.67	0.92
Cadmium	MG/KG	3.2	86%	2.3	2	153	178	0.56	0.54	0.43	0.42	0.49	0.39
Calcium	MG/KG	214000	100%	121000	1	178	178	3150 J	2880 J	1670 J	85500 J	3760 J	3270 J
Chromium	MG/KG	39.3	100%	29.6	2	178	178	20.9 J	18.4 J	17.2 J	12.2 J	19.7 J	20.2 J
Cobalt	MG/KG	47.8	100%	30	2	178	178	9.8 J	10.9 J	11 J	5.1 J	8.9 J	10.6 J
Copper	MG/KG	305	100%	33	19	178	178	27.4 J	25.6 J	9.8 J	15.7 J	20.5 J	23.8 J
Cyanide	MG/KG	0	0%	0.35	0	0	9						
Iron	MG/KG	64000	100%	36500	1	178	178	23500 J	24500 J	21800 J	15600 J	23200 J	23900 J
Lead	MG/KG	164	100%	24.8	75	178	178	13.9 J	14.5 J	21.3 J	7.9 J	12.2 J	17.5 J
Magnesium	MG/KG	30200	100%	21500	3	178	178	4780 J	4540 J	3080 J	14600 J	4860 J	4560 J
Manganese	MG/KG	1290	100%	1060	3	178	178	708 J	568 J	271 J	331 J	455 J	417 J
Mercury	MG/KG	0.95	95%	0.1	37	169	178	0.05	0.06	0.04	0.03 J	0.03 J	0.08
Nickel	MG/KG	88.3	100%	49	3	178	178	34.9 J	32.3 J	16.3 J	19.4 J	27.3 J	29.4 J
Potassium	MG/KG	2290	100%	2380	0	178	178	1100 J	818 J	723 J	874 J	1060 J	1080 J
Selenium	MG/KG	1.5	9%	2	0	16	178	0.43 U	0.41 U	0.46 U	0.4 U	0.55 J	0.5 U
Silver	MG/KG	2.9	49%	0.75	62	87	178	0.58	0.67	0.67	0.1 U	0.74	1.2
Sodium	MG/KG	4060	99%	172	86	177	178	166 J	1200 J	463 J	180 J	87.2 J	202 J

**Table A-2A
SURFACE SOIL SAMPLE RESULTS (0-2 ft.)
SEAD-59
SEAD-59 and SEAD-71 Phase II RI Report
Seneca Army Depot Activity**

				SEAD-59	SEAD-59	SEAD-59	SEAD-59	SEAD-59	SEAD-59	SEAD-59			
				CL-59-01-F21	CL-59-01-F22	CL-59-01-F24	CL-59-01-F25	CL-59-01-F26	CL-59-01-F26	CL-59-01-F26			
				SOIL	SOIL	SOIL	SOIL	SOIL	SOIL	SOIL			
				CL-59-01-F21	CL-59-01-F22	CL-59-01-F24	CL-59-01-F25	CL-59-01-F26	CL-59-01-F26	CL-59-01-F26			
				0	0	0	0	0	0	0			
				0	0	0	0	0	0	0			
				5/6/2004	5/6/2004	5/6/2004	5/6/2004	5/6/2004	5/6/2004	5/6/2004			
				SA	SA	SA	SA	SA	SA	SA			
				ENSR IRM	ENSR IRM	ENSR IRM	ENSR IRM	ENSR IRM	ENSR IRM	ENSR IRM			
				1	1	1	1	1	1	1			
Parameter	Units	Maximum Value	Frequency of Detection	NYSDEC TAGM 4046⁽²⁾	Number of Exceedances	Number of Detects	Number of Analyses⁽³⁾	Value (Q)	Value (Q)	Value (Q)	Value (Q)	Value (Q)	Value (Q)
Thallium	MG/KG	1.8	29%	0.7	24	51	178	0.21 U	0.2 U	0.23 U	0.2 U	0.23 U	0.25 U
Vanadium	MG/KG	28.5	100%	150	0	178	178	21.8 J	21.5 J	24.3 J	12.9 J	22.9 J	22.6 J
Zinc	MG/KG	341	100%	110	19	178	178	80.5 J	65.4 J	44.6 J	58.2 J	59 J	78.5 J

Note(s):

(1) - Historical sample depths are presented (I.e. prior to 2002 TCRA)

(2) - NYSDEC Technical and Administrative Guidance Memorandum (TAGM) HWR-94-4046, Revised January 24, 1994

(3) - Sample/Duplicate pair are presented as individual samples in this table. Statistical information used Sample Duplicate pairs as a single entity and averaged result values were used in risk assessment analysis.

U = compound was not detected

J = the reported value is an estimated concentration

UJ = the compound was not detected; the associated reporting limit is approximate

R = the data was rejected in the data validating process

NJ = compound was "tentatively identified" and the associated numerical value is approximate

Table A-2A
SURFACE SOIL SAMPLE RESULTS (0-2 ft.)
SEAD-59
SEAD-59 and SEAD-71 Phase II RI Report
Seneca Army Depot Activity

Facility	SEAD-59	SEAD-59	SEAD-59	SEAD-59	SEAD-59	SEAD-59
Location ID	CL-59-01-WE2	CL-59-01-WE3	CL-59-01-WE4	CL-59-01-WE5	CL-59-01-WN1	CL-59-01-WN2
Maxtrix	SOIL	SOIL	SOIL	SOIL	SOIL	SOIL
Sample ID	CL-59-01-WE2	CL-59-01-WE3	CL-59-01-WE4	CL-59-01-WE5	CL-59-01-WN1	CL-59-01-WN2
Sample Depth to Top of Sample ⁽¹⁾	0	0	0	0	0	0
Sample Depth to Bottom of Sample ⁽¹⁾	0	0	0	0	0	0
Sample Date	5/6/2004	5/6/2004	5/6/2004	5/6/2004	5/6/2004	5/6/2004
QC Code	SA	SA	SA	SA	SA	SA
Study ID	ENSR IRM	ENSR IRM	ENSR IRM	ENSR IRM	ENSR IRM	ENSR IRM
Sample Round	1	1	1	1	1	1

Parameter	Units	Maximum Value	Frequency of Detection	NYSDEC TAGM 4046 ⁽²⁾	Number of Exceedances	Number of Detects	Number of Analyses ⁽³⁾	Value (Q)	Value (Q)	Value (Q)	Value (Q)	Value (Q)	Value (Q)
Volatile Organics													
1,1,1-Trichloroethane	UG/KG	0	0%	800	0	0	177	6 U	6 U	23 U	6 U	5 U	6 U
1,1,2,2-Tetrachloroethane	UG/KG	0	0%	600	0	0	169	6 U	6 U	23 U	6 U	5 UJ	6 R
1,1,2-Trichloro-1,2,2-Trifluoroethane	UG/KG	0	0%		0	0	168	6 U	6 U	23 U	6 U	5 U	6 U
1,1,2-Trichloroethane	UG/KG	0	0%		0	0	107	6 U	6 U	23 U	6 U	5 U	6 U
1,1-Dichloroethane	UG/KG	0	0%	200	0	0	177	6 U	6 U	23 U	6 U	5 U	6 U
1,1-Dichloroethene	UG/KG	8	2%	400	0	3	177	6 U	6 U	23 U	6 U	5 U	6 U
1,2,3-Trichloropropane	UG/KG	0	0%		0	0	70						
1,2,4-Trichlorobenzene	UG/KG	0	0%	3400	0	0	161	6 UJ	6 U	23 U	6 U	5 UJ	6 R
1,2-Dibromo-3-chloropropane	UG/KG	0	0%		0	0	91	6 UJ	6 U	23 U	6 U	5 UJ	6 R
1,2-Dibromoethane	UG/KG	0	0%		0	0	98	6 U	6 U	23 U	6 U	5 U	6 UJ
1,2-Dichlorobenzene	UG/KG	0	0%	7900	0	0	161	6 UJ	6 U	23 U	6 U	5 UJ	6 R
1,2-Dichloroethane	UG/KG	0	0%	100	0	0	177	6 U	6 U	23 U	6 U	5 U	6 U
1,2-Dichloroethene (total)	UG/KG	0	0%		0	0	9						
1,2-Dichloropropane	UG/KG	0	0%		0	0	107	6 U	6 U	23 U	6 U	5 U	6 U
1,3-Dichlorobenzene	UG/KG	0	0%	1600	0	0	161	6 UJ	6 U	23 U	6 U	5 UJ	6 R
1,3-Dichloropropane	UG/KG	0	0%		0	0	70						
1,4-Dichlorobenzene	UG/KG	0	0%	8500	0	0	161	6 UJ	6 U	23 U	6 U	5 UJ	6 R
Acetone	UG/KG	550	27%	200	2	47	177	110 NJ	220 NJ	550 NJ	45 NJ	5 U	6 U
Benzene	UG/KG	3	4%	60	7	7	177	6 U	6 U	23 U	6 U	5 U	6 U
Bromodichloromethane	UG/KG	0	0%		0	0	107	6 U	6 U	23 U	6 U	5 U	6 U
Bromoform	UG/KG	0	0%		0	0	107	6 U	6 U	23 U	6 U	5 U	6 UJ
Carbon disulfide	UG/KG	4	3%	2700	0	6	177	6 U	6 U	23 U	6 U	5 U	6 U
Carbon tetrachloride	UG/KG	0	0%	600	0	0	177	6 U	6 U	23 U	6 U	5 U	6 U
Chlorobenzene	UG/KG	0	0%	1700	0	0	177	6 U	6 U	23 U	6 U	5 U	6 UJ
Chlorodibromomethane	UG/KG	0	0%		0	0	177	6 U	6 U	23 U	6 U	5 U	6 UJ
Chloroethane	UG/KG	0	0%	1900	0	0	177	6 U	6 U	23 U	6 U	5 U	6 U
Chloroform	UG/KG	0	0%	300	0	0	177	6 U	6 U	23 U	6 U	5 U	6 U
Cis-1,2-Dichloroethene	UG/KG	0	0%		0	0	98	6 U	6 U	23 U	6 U	5 U	6 U
Cis-1,3-Dichloropropene	UG/KG	0	0%		0	0	107	6 U	6 U	23 U	6 U	5 U	6 U
Cyclohexane	UG/KG	3	8%		0	8	98	6 U	6 U	23 U	6 U	5 U	6 U
Dichlorodifluoromethane	UG/KG	0	0%		0	0	98	6 U	6 U	23 U	6 U	5 U	6 UJ
Ethyl benzene	UG/KG	4.6	1%	5500	0	2	177	6 U	6 U	23 U	6 U	5 U	6 UJ
Isopropylbenzene	UG/KG	0	0%		0	0	98	6 U	6 U	23 U	6 U	5 U	6 UJ
Meta/Para Xylene	UG/KG	9.4	4%		0	3	70						
Methyl Acetate	UG/KG	2	3%		0	3	98	6 U	6 U	23 U	6 U	5 U	6 U
Methyl Tertbutyl Ether	UG/KG	0	0%		0	0	98	6 U	6 U	23 U	6 U	5 U	6 U
Methyl bromide	UG/KG	0	0%		0	0	107	6 U	6 U	23 U	6 U	5 U	6 U
Methyl butyl ketone	UG/KG	0	0%		0	0	107	6 U	6 U	23 U	6 U	5 U	6 UJ
Methyl chloride	UG/KG	0	0%		0	0	107	6 U	6 U	23 U	6 U	5 U	6 U
Methyl cyclohexane	UG/KG	5	10%		0	10	98	6 U	6 U	23 U	6 U	5 U	6 U
Methyl ethyl ketone	UG/KG	190	12%	300	0	22	177	13 J	61 J	190 J	6 U	5 U	6 U
Methyl isobutyl ketone	UG/KG	1.9	1%	1000	0	1	177	6 U	6 U	23 U	6 U	5 U	6 U
Methylene chloride	UG/KG	4.9	20%	100	0	36	178	6 U	6 UJ	23 UJ	6 UJ	5 U	7 U
Ortho Xylene	UG/KG	5.05	4%		0	3	70						

Table A-2A
SURFACE SOIL SAMPLE RESULTS (0-2 ft.)
SEAD-59
SEAD-59 and SEAD-71 Phase II RI Report
Seneca Army Depot Activity

Facility	SEAD-59	SEAD-59	SEAD-59	SEAD-59	SEAD-59	SEAD-59							
Location ID	CL-59-01-WE2	CL-59-01-WE3	CL-59-01-WE4	CL-59-01-WE5	CL-59-01-WN1	CL-59-01-WN2							
Maxtrix	SOIL	SOIL	SOIL	SOIL	SOIL	SOIL							
Sample ID	CL-59-01-WE2	CL-59-01-WE3	CL-59-01-WE4	CL-59-01-WE5	CL-59-01-WN1	CL-59-01-WN2							
Sample Depth to Top of Sample ⁽¹⁾	0	0	0	0	0	0							
Sample Depth to Bottom of Sample ⁽¹⁾	0	0	0	0	0	0							
Sample Date	5/6/2004	5/6/2004	5/6/2004	5/6/2004	5/6/2004	5/6/2004							
QC Code	SA	SA	SA	SA	SA	SA							
Study ID	ENSR IRM	ENSR IRM	ENSR IRM	ENSR IRM	ENSR IRM	ENSR IRM							
Sample Round	1	1	1	1	1	1							
Parameter	Units	Maximum Value	Frequency of Detection	NYSDEC TAGM 4046 ⁽²⁾	Number of Exceedances	Number of Detects	Number of Analyses ⁽³⁾	Value (Q)	Value (Q)	Value (Q)	Value (Q)	Value (Q)	Value (Q)
Styrene	UG/KG	0	0%		0	0	107	6 U	6 U	23 U	6 U	5 U	6 UJ
Tetrachloroethene	UG/KG	6.4	3%	1400	0	5	177	6 U	6 U	23 U	6 U	5 U	6 UJ
Toluene	UG/KG	8	8%	1500	0	14	177	6 U	6 U	23 U	6 U	5 U	6 U
Total BTEX	MG/KG	3.25	67%		0	2	3						
Total Xylenes	UG/KG	3	7%	1200	0	7	102	6 UJ	6 U	23 U	6 U	5 UJ	6 R
Trans-1,2-Dichloroethene	UG/KG	0	0%	300	0	0	168	6 U	6 U	23 U	6 U	5 U	6 U
Trans-1,3-Dichloropropene	UG/KG	0	0%		0	0	107	6 U	6 U	23 U	6 U	5 U	6 U
Trichloroethene	UG/KG	4.5	5%	700	0	8	177	6 U	6 U	23 U	6 U	5 U	6 U
Trichlorofluoromethane	UG/KG	6	1%		0	1	98	6 U	6 U	23 U	6 U	5 U	6 U
Vinyl chloride	UG/KG	0	0%	200	0	0	177	6 U	6 U	23 U	6 U	5 U	6 U
Semivolatile Organics													
1,1'-Biphenyl	UG/KG	254.5	2%		0	2	99	420 U	410 U	460 U	390 U	360 U	59 NJ
1,2,4-Trichlorobenzene	UG/KG	0	0%	3400	0	0	9						
1,2-Dichlorobenzene	UG/KG	0	0%	7900	0	0	9						
1,3-Dichlorobenzene	UG/KG	0	0%	1600	0	0	9						
1,4-Dichlorobenzene	UG/KG	0	0%	8500	0	0	9						
2,2'-oxybis(1-Chloropropane)	UG/KG	0	0%		0	0	105	420 U	410 UJ	460 UJ	390 U	360 U	430 U
2,4,5-Trichlorophenol	UG/KG	0	0%	100	0	0	178	1100 U	1000 U	1200 U	980 U	920 U	1100 U
2,4,6-Trichlorophenol	UG/KG	0	0%		0	0	178	420 U	410 U	460 U	390 U	360 U	430 U
2,4-Dichlorophenol	UG/KG	0	0%	400	0	0	178	420 U	410 U	460 U	390 U	360 U	430 U
2,4-Dimethylphenol	UG/KG	0	0%		0	0	108	420 U	410 U	460 U	390 U	360 U	430 U
2,4-Dinitrophenol	UG/KG	0	0%	200	0	0	178	1100 U	1000 U	1200 U	980 U	920 U	1100 U
2,4-Dinitrotoluene	UG/KG	0	0%		0	0	178	420 U	410 U	460 U	390 U	360 U	430 U
2,6-Dinitrotoluene	UG/KG	0	0%	1000	0	0	178	420 U	410 U	460 U	390 U	360 U	430 U
2-Chloronaphthalene	UG/KG	0	0%		0	0	108	420 U	410 U	460 U	390 U	360 U	430 U
2-Chlorophenol	UG/KG	0	0%	800	0	0	178	420 U	410 U	460 U	390 U	360 U	430 U
2-Methylnaphthalene	UG/KG	1295	19%	36400	0	34	178	420 U	410 U	460 U	390 U	360 U	420 J
2-Methylphenol	UG/KG	0	0%	100	0	0	178	420 U	410 U	460 U	390 U	360 U	430 U
2-Nitroaniline	UG/KG	0	0%	430	0	0	178	1100 U	1000 U	1200 U	980 U	920 U	1100 U
2-Nitrophenol	UG/KG	0	0%	330	0	0	178	420 U	410 U	460 U	390 U	360 U	430 U
3,3'-Dichlorobenzidine	UG/KG	0	0%		0	0	178	420 U	410 UJ	460 UJ	390 U	360 U	430 U
3-Nitroaniline	UG/KG	0	0%	500	0	0	178	1100 U	1000 U	1200 U	980 U	920 U	1100 U
4,6-Dinitro-2-methylphenol	UG/KG	0	0%		0	0	108	1100 U	1000 U	1200 U	980 U	920 U	1100 U
4-Bromophenyl phenyl ether	UG/KG	0	0%		0	0	108	420 U	410 U	460 U	390 U	360 U	430 U
4-Chloro-3-methylphenol	UG/KG	0	0%	240	0	0	178	420 U	410 U	460 U	390 U	360 U	430 U
4-Chloroaniline	UG/KG	1200	1%	220	1	2	178	420 U	410 U	460 U	390 U	360 U	430 U
4-Chlorophenyl phenyl ether	UG/KG	0	0%		0	0	108	420 U	410 U	460 U	390 U	360 U	430 U
4-Methylphenol	UG/KG	150	3%	900	0	5	178	420 U	410 U	90 J	390 U	360 U	24 NJ
4-Nitroaniline	UG/KG	0	0%		0	0	108	1100 U	1000 U	1200 U	980 U	920 U	1100 U
4-Nitrophenol	UG/KG	0	0%	100	0	0	178	1100 U	1000 U	1200 U	980 U	920 U	1100 U
Acenaphthene	UG/KG	2680	24%	50000	0	42	178	420 U	410 U	460 U	390 U	360 U	430 U
Acenaphthylene	UG/KG	1700	37%	41000	0	66	178	420 U	410 U	460 U	390 U	360 U	90 J
Acetophenone	UG/KG	0	0%		0	0	99	420 U	410 U	460 U	390 U	360 U	430 U
Aniline	UG/KG	0	0%		0	0	70						
Anthracene	UG/KG	4395	43%	50000	0	77	178	420 U	410 U	460 U	390 U	360 U	130 J

**Table A-2A
SURFACE SOIL SAMPLE RESULTS (0-2 ft.)
SEAD-59
SEAD-59 and SEAD-71 Phase II RI Report
Seneca Army Depot Activity**

Facility	SEAD-59	SEAD-59	SEAD-59	SEAD-59	SEAD-59	SEAD-59							
Location ID	CL-59-01-WE2	CL-59-01-WE3	CL-59-01-WE4	CL-59-01-WE5	CL-59-01-WN1	CL-59-01-WN2							
Maxtrix	SOIL	SOIL	SOIL	SOIL	SOIL	SOIL							
Sample ID	CL-59-01-WE2	CL-59-01-WE3	CL-59-01-WE4	CL-59-01-WE5	CL-59-01-WN1	CL-59-01-WN2							
Sample Depth to Top of Sample ⁽¹⁾	0	0	0	0	0	0							
Sample Depth to Bottom of Sample ⁽¹⁾	0	0	0	0	0	0							
Sample Date	5/6/2004	5/6/2004	5/6/2004	5/6/2004	5/6/2004	5/6/2004							
QC Code	SA	SA	SA	SA	SA	SA							
Study ID	ENSR IRM	ENSR IRM	ENSR IRM	ENSR IRM	ENSR IRM	ENSR IRM							
Sample Round	1	1	1	1	1	1							
Parameter	Units	Maximum Value	Frequency of Detection	NYSDEC TAGM 4046 ⁽²⁾	Number of Exceedances	Number of Detects	Number of Analyses ⁽³⁾	Value (Q)	Value (Q)	Value (Q)	Value (Q)	Value (Q)	Value (Q)
Atrazine	UG/KG	120	1%		0	1	99	420 U	410 U	460 U	390 U	360 U	120 J
Benzaldehyde	UG/KG	50	1%		0	1	99	420 U	410 U	50 J	390 U	360 U	430 U
Benzo(a)anthracene	UG/KG	8900	51%	224	72	90	178	420 U	410 U	460 U	390 U	360 U	360 J
Benzo(a)pyrene	UG/KG	8050	51%	61	84	91	178	420 U	410 U	460 U	390 U	360 U	330 J
Benzo(b)fluoranthene	UG/KG	6800	52%	1100	40	92	178	420 U	410 U	460 U	390 U	360 U	670
Benzo(ghi)perylene	UG/KG	5200	46%	50000	0	82	178	420 U	410 U	460 U	390 U	360 U	250 J
Benzo(k)fluoranthene	UG/KG	7350	49%	1100	35	88	178	420 U	410 U	460 U	390 U	360 U	220 J
Benzoic Acid	UG/KG	0	0%	2700	0	0	70						
Bis(2-Chloroethoxy)methane	UG/KG	0	0%		0	0	108	420 U	410 U	460 U	390 U	360 U	430 U
Bis(2-Chloroethyl)ether	UG/KG	0	0%		0	0	108	420 U	410 U	460 U	390 U	360 U	430 U
Bis(2-Chloroisopropyl)ether	UG/KG	0	0%		0	0	3						
Bis(2-Ethylhexyl)phthalate	UG/KG	990	19%	50000	0	34	178	420 U	410 U	460 U	390 U	25 J	44 NJ
Butylbenzylphthalate	UG/KG	0	0%	50000	0	0	178	420 U	410 U	460 U	390 U	360 U	430 U
Caprolactam	UG/KG	0	0%		0	0	99	420 U	410 U	460 U	390 U	360 U	430 U
Carbazole	UG/KG	755	19%		0	20	108	420 U	410 U	460 U	390 U	360 U	98 J
Chrysene	UG/KG	8900	51%	400	62	91	178	420 U	410 U	460 U	390 U	360 U	550 NJ
Di-n-butylphthalate	UG/KG	965	2%	8100	0	4	178	420 U	410 U	460 U	390 U	360 U	430 U
Di-n-octylphthalate	UG/KG	0	0%	50000	0	0	178	420 U	410 U	460 U	390 U	360 U	430 U
Dibenz(a,h)anthracene	UG/KG	1665	38%	14	67	68	178	420 U	410 U	460 U	390 U	360 U	67 J
Dibenzofuran	UG/KG	2350	16%	6200	0	28	178	420 U	410 U	460 U	390 U	360 U	110 J
Diethyl phthalate	UG/KG	10	1%	7100	0	1	178	420 U	410 U	460 U	390 U	360 U	430 U
Dimethylphthalate	UG/KG	0	0%	2000	0	0	178	420 U	410 U	460 U	390 U	360 U	430 U
Fluoranthene	UG/KG	23500	54%	50000	0	97	178	420 U	410 U	460 U	390 U	360 U	930
Fluorene	UG/KG	2640	28%	50000	0	49	178	420 U	410 U	460 U	390 U	360 U	40 NJ
Hexachlorobenzene	UG/KG	0	0%	410	0	0	178	420 U	410 U	460 U	390 U	360 U	430 U
Hexachlorobutadiene	UG/KG	0	0%		0	0	178	420 U	410 U	460 U	390 U	360 U	430 U
Hexachlorocyclopentadiene	UG/KG	0	0%		0	0	108	420 U	410 U	460 U	390 U	360 U	430 U
Hexachloroethane	UG/KG	0	0%		0	0	178	420 U	410 U	460 U	390 U	360 U	430 U
Indeno(1,2,3-cd)pyrene	UG/KG	4950	47%	3200	2	84	178	420 U	410 U	460 U	390 U	360 U	270 J
Isophorone	UG/KG	0	0%	4400	0	0	178	420 U	410 U	460 U	390 U	360 U	430 U
N-Nitrosodiphenylamine	UG/KG	100	1%		0	1	108	420 U	410 U	460 U	390 U	360 U	100 J
N-Nitrosodipropylamine	UG/KG	0	0%		0	0	108	420 U	410 U	460 U	390 U	360 U	430 U
Naphthalene	UG/KG	1800	19%	13000	0	34	178	420 U	410 U	460 U	390 U	360 U	170 J
Nitrobenzene	UG/KG	0	0%	200	0	0	178	420 U	410 U	460 U	390 U	360 U	430 U
Pentachlorophenol	UG/KG	0	0%	1000	0	0	178	1100 U	1000 U	1200 U	980 U	920 U	1100 U
Phenanthrene	UG/KG	21300	51%	50000	0	90	178	420 U	410 U	460 U	390 U	360 U	580
Phenol	UG/KG	0	0%	30	0	0	178	420 U	410 U	460 U	390 U	360 U	430 U
Pyrene	UG/KG	19200	55%	50000	0	98	178	420 U	410 U	460 U	390 U	360 U	900
Pyridine	UG/KG	0	0%		0	0	100		410 U	460 U	390 U		
Total Unknown PAHs as SV	MG/KG	25	100%		0	3	3						
Pesticides/PCBs													
4,4'-DDD	UG/KG	740	28%	2900	0	49	178	4.2 U	4.1 U	4.6 U	20 U	9.7	740 J
4,4'-DDE	UG/KG	2600	37%	2100	1	65	178	4.2 U	4.1 U	10	20 U	35	2600
4,4'-DDT	UG/KG	3700	33%	2100	1	59	178	4.2 U	4.1 U	4.6 U	57	6.1	3700
Aldrin	UG/KG	1.2	1%	41	0	1	178	2.2 U	2.1 U	2.4 U	10 U	1.9 U	220 U

Table A-2A
SURFACE SOIL SAMPLE RESULTS (0-2 ft.)
SEAD-59
SEAD-59 and SEAD-71 Phase II RI Report
Seneca Army Depot Activity

Facility	SEAD-59						SEAD-59						
Location ID	CL-59-01-WE2		CL-59-01-WE3		CL-59-01-WE4		CL-59-01-WE5		CL-59-01-WN1		CL-59-01-WN2		
Maxtrix	SOIL						SOIL						
Sample ID	CL-59-01-WE2		CL-59-01-WE3		CL-59-01-WE4		CL-59-01-WE5		CL-59-01-WN1		CL-59-01-WN2		
Sample Depth to Top of Sample ⁽¹⁾	0						0						
Sample Depth to Bottom of Sample ⁽¹⁾	0						0						
Sample Date	5/6/2004		5/6/2004		5/6/2004		5/6/2004		5/6/2004		5/6/2004		
QC Code	SA		SA		SA		SA		SA		SA		
Study ID	ENSR IRM		ENSR IRM		ENSR IRM		ENSR IRM		ENSR IRM		ENSR IRM		
Sample Round	1		1		1		1		1		1		
Parameter	Units	Maximum Value	Frequency of Detection	NYSDEC TAGM 4046 ⁽²⁾	Number of Exceedances	Number of Detects	Number of Analyses ⁽³⁾	Value (Q)	Value (Q)	Value (Q)	Value (Q)	Value (Q)	Value (Q)
Alpha-BHC	UG/KG	0	0%	110	0	0	178	2.2 U	2.1 U	2.4 U	10 U	1.9 U	220 UJ
Alpha-Chlordane	UG/KG	34	4%		0	7	178	2.2 U	2.1 U	2.4 U	10 U	1.9 U	220 U
Beta-BHC	UG/KG	2.4	1%	200	0	1	178	2.2 U	2.1 U	2.4 U	10 U	1.9 U	220 U
Delta-BHC	UG/KG	0	0%	300	0	0	178	2.2 U	2.1 U	2.4 U	10 U	1.9 U	220 U
Dieldrin	UG/KG	0	0%	44	0	0	178	4.2 U	4.1 U	4.6 U	20 U	3.6 U	430 U
Endosulfan I	UG/KG	16	1%	900	0	1	178	2.2 U	2.1 U	2.4 U	10 U	1.9 U	220 U
Endosulfan II	UG/KG	0	0%	900	0	0	178	4.2 U	4.1 U	4.6 U	20 U	3.6 U	430 U
Endosulfan sulfate	UG/KG	6.2	1%	1000	0	1	178	4.2 U	4.1 U	4.6 U	20 U	3.6 U	430 U
Endrin	UG/KG	16	2%	100	0	3	178	4.2 U	4.1 U	4.6 U	20 U	3.6 U	430 U
Endrin aldehyde	UG/KG	4.9	1%		0	2	178	4.2 U	4.1 U	4.6 U	20 U	3.6 U	430 U
Endrin ketone	UG/KG	38	2%		0	4	178	4.2 U	4.1 U	4.6 U	20 U	3.6 U	430 U
Gamma-BHC/Lindane	UG/KG	0	0%	60	0	0	178	2.2 U	2.1 U	2.4 U	10 U	1.9 U	220 U
Gamma-Chlordane	UG/KG	24	8%	540	0	14	178	2.2 U	2.1 UJ	2.4 UJ	10 UJ	1.9 U	220 U
Heptachlor	UG/KG	0	0%	100	0	0	178	2.2 U	2.1 U	2.4 U	10 U	1.9 U	220 U
Heptachlor epoxide	UG/KG	3	1%	20	0	2	178	2.2 U	2.1 U	2.4 U	10 U	1.9 U	220 U
Methoxychlor	UG/KG	0	0%		0	0	178	22 U	21 U	24 U	100 U	19 U	2200 U
Toxaphene	UG/KG	0	0%		0	0	178	220 U	210 U	240 U	1000 U	190 U	22000 U
Aroclor-1016	UG/KG	0	0%		0	0	178	42 U	42 U	46 U	40 U	37 U	44 U
Aroclor-1221	UG/KG	0	0%		0	0	178	42 U	42 U	46 U	40 U	37 U	44 U
Aroclor-1232	UG/KG	0	0%		0	0	178	42 U	42 U	46 U	40 U	37 U	44 U
Aroclor-1242	UG/KG	0	0%		0	0	178	42 U	42 U	46 U	40 U	37 U	44 U
Aroclor-1248	UG/KG	0	0%		0	0	178	42 U	42 U	46 U	40 U	37 U	44 U
Aroclor-1254	UG/KG	0	0%	10000	0	0	178	42 U	42 U	46 U	40 U	37 U	44 U
Aroclor-1260	UG/KG	79	1%	10000	0	2	178	42 U	42 U	46 U	40 U	37 U	44 U
Metals													
Aluminum	MG/KG	18300	100%	19300	0	178	178	13900 J	12900	13000	16200 J	13900 J	16300 J
Antimony	MG/KG	424	58%	5.9	5	104	178	1.3 J	1.8 J	1.9 J	1.6 J	1.4 J	5.1 J
Arsenic	MG/KG	32.2	100%	8.2	7	178	178	6.9 J	5.6	5	5 J	6.7	32.2
Barium	MG/KG	304	100%	300	1	178	178	139 J	132 J	126 J	199 J	110 J	115 J
Beryllium	MG/KG	2.6	99%	1.1	2	176	178	0.76	0.75	0.75	0.79	0.68	2.6
Cadmium	MG/KG	3.2	86%	2.3	2	153	178	0.41	0.8	0.99	0.77	0.25 J	2.5
Calcium	MG/KG	214000	100%	121000	1	178	178	3510 J	3580	6380	1860 J	3880	9170
Chromium	MG/KG	39.3	100%	29.6	2	178	178	19.5 J	18.3 J	18.3 J	22.3 J	20.4 J	39.3 J
Cobalt	MG/KG	47.8	100%	30	2	178	178	9.4 J	10.2	8.6	9.7 J	9	47.8
Copper	MG/KG	305	100%	33	3	178	178	18.9 J	19.5	33.5	19.2 J	22.4 J	194 J
Cyanide	MG/KG	0	0%	0.35	0	0	9						
Iron	MG/KG	64000	100%	36500	1	178	178	24500 J	22800	20200	23600 J	25100 J	64000 J
Lead	MG/KG	164	100%	24.8	75	178	178	15.9 J	18.6 J	25.7 J	15.2 J	14.4 J	140 J
Magnesium	MG/KG	30200	100%	21500	3	178	178	3850 J	4010 J	3470 J	4230 J	4630 J	5480 J
Manganese	MG/KG	1290	100%	1060	3	178	178	544 J	583 J	665 J	417 J	360 J	836 J
Mercury	MG/KG	0.95	95%	0.1	37	169	178	0.06	0.08	0.1	0.07	0.08	0.15
Nickel	MG/KG	88.3	100%	49	3	178	178	26.1 J	28 J	24.5 J	25.9 J	29.2 J	88.3 J
Potassium	MG/KG	2290	100%	2380	0	178	178	1230 J	1180	1250	1380 J	1200	1640
Selenium	MG/KG	1.5	9%	2	0	16	178	0.45 U	0.45 U	1.5 J	0.45 U	0.43 U	0.49 U
Silver	MG/KG	2.9	49%	0.75	62	87	178	1.3	0.8	0.81	0.77	2	2.3
Sodium	MG/KG	4060	99%	172	86	177	178	108 J	354	2400	4060 J	159	186

**Table A-2A
SURFACE SOIL SAMPLE RESULTS (0-2 ft.)
SEAD-59
SEAD-59 and SEAD-71 Phase II RI Report
Seneca Army Depot Activity**

				SEAD-59	SEAD-59	SEAD-59	SEAD-59	SEAD-59	SEAD-59	SEAD-59	SEAD-59		
				CL-59-01-WE2	CL-59-01-WE3	CL-59-01-WE4	CL-59-01-WE5	CL-59-01-WN1	CL-59-01-WN2	CL-59-01-WN1	CL-59-01-WN2		
				SOIL	SOIL	SOIL	SOIL	SOIL	SOIL	SOIL	SOIL		
				CL-59-01-WE2	CL-59-01-WE3	CL-59-01-WE4	CL-59-01-WE5	CL-59-01-WN1	CL-59-01-WN2	CL-59-01-WN1	CL-59-01-WN2		
Sample Depth to Top of Sample ⁽¹⁾				0	0	0	0	0	0	0	0		
Sample Depth to Bottom of Sample ⁽¹⁾				0	0	0	0	0	0	0	0		
Sample Date				5/6/2004	5/6/2004	5/6/2004	5/6/2004	5/6/2004	5/6/2004	5/6/2004	5/6/2004		
QC Code				SA	SA	SA	SA	SA	SA	SA	SA		
Study ID				ENSR IRM	ENSR IRM	ENSR IRM	ENSR IRM	ENSR IRM	ENSR IRM	ENSR IRM	ENSR IRM		
Sample Round				1	1	1	1	1	1	1	1		
Parameter	Units	Maximum Value	Frequency of Detection	NYSDEC TAGM 4046 ⁽²⁾	Number of Exceedances	Number of Detects	Number of Analyses ⁽³⁾	Value (Q)	Value (Q)	Value (Q)	Value (Q)	Value (Q)	Value (Q)
Thallium	MG/KG	1.8	29%	0.7	24	51	178	0.22 U	0.22 U	0.28 U	0.23 U	0.22 U	0.25 U
Vanadium	MG/KG	28.5	100%	150	0	178	178	23 J	21.2 J	21.3 J	24.3 J	22.8 J	26 J
Zinc	MG/KG	341	100%	110	19	178	178	90.8 J	69 J	90.4 J	105 J	147 J	298 J

Note(s):

(1) - Historical sample depths are presented (I.e. prior to 2002 TCRA)

(2) - NYSDEC Technical and Administrative Guidance Memorandum (TAGM) HWR-94-4046, Revised January 24, 1994

(3) - Sample/Duplicate pair are presented as individual samples in this table. Statistical information used Sample Duplicate pairs as a single entity and averaged result values were used in risk assessment analysis.

U = compound was not detected

J = the reported value is an estimated concentration

UJ = the compound was not detected; the associated reporting limit is approximate

R = the data was rejected in the data validating process

NJ = compound was "tentatively identified" and the associated numerical value is approximate

**Table A-2A
SURFACE SOIL SAMPLE RESULTS (0-2 ft.)
SEAD-59
SEAD-59 and SEAD-71 Phase II RI Report
Seneca Army Depot Activity**

Facility	SEAD-59	SEAD-59	SEAD-59	SEAD-59	SEAD-59	SEAD-59							
Location ID	CL-59-01-WN3	CL-59-01-WN4	CL-59-01-WN5	CL-59-01-WN6	CL-59-01-WS2	CL-59-01-WS3							
Maxtrix	SOIL	SOIL	SOIL	SOIL	SOIL	SOIL							
Sample ID	CL-59-01-WN3	CL-59-01-WN4	CL-59-01-WN5	CL-59-01-WN6	CL-59-01-WS2	CL-59-01-WS3							
Sample Depth to Top of Sample ⁽¹⁾	0	0	0	0	0	0							
Sample Depth to Bottom of Sample ⁽¹⁾	0	0	0	0	0	0							
Sample Date	5/6/2004	5/6/2004	5/6/2004	5/6/2004	5/6/2004	5/6/2004							
QC Code	SA	SA	SA	SA	SA	SA							
Study ID	ENSR IRM	ENSR IRM	ENSR IRM	ENSR IRM	ENSR IRM	ENSR IRM							
Sample Round	1	1	1	1	1	1							
Parameter	Units	Maximum Value	Frequency of Detection	NYSDEC TAGM 4046 ⁽²⁾	Number of Exceedances	Number of Detects	Number of Analyses ⁽³⁾	Value (Q)	Value (Q)	Value (Q)	Value (Q)	Value (Q)	Value (Q)
Volatile Organics													
1,1,1-Trichloroethane	UG/KG	0	0%	800	0	0	177	7 U	6 U	5 U	6 U	6 U	5 U
1,1,2,2-Tetrachloroethane	UG/KG	0	0%	600	0	0	169	7 UJ	6 UJ	5 UJ	6 UJ	6 U	5 U
1,1,2-Trichloro-1,2,2-Trifluoroethane	UG/KG	0	0%		0	0	168	7 U	6 U	5 U	6 U	6 U	5 U
1,1,2-Trichloroethane	UG/KG	0	0%		0	0	107	7 U	6 U	5 U	6 U	6 U	5 U
1,1-Dichloroethane	UG/KG	0	0%	200	0	0	177	7 U	6 U	5 U	6 U	6 U	5 U
1,1-Dichloroethene	UG/KG	8	2%	400	0	3	177	7 U	6 U	5 U	6 U	1 J	5 U
1,2,3-Trichloropropane	UG/KG	0	0%		0	0	70						
1,2,4-Trichlorobenzene	UG/KG	0	0%	3400	0	0	161	7 UJ	6 UJ	5 UJ	6 UJ	6 U	5 U
1,2-Dibromo-3-chloropropane	UG/KG	0	0%		0	0	91	7 UJ	6 UJ	5 UJ	6 UJ	6 U	5 U
1,2-Dibromoethane	UG/KG	0	0%		0	0	98	7 UJ	6 U	5 U	6 U	6 U	5 U
1,2-Dichlorobenzene	UG/KG	0	0%	7900	0	0	161	7 UJ	6 UJ	5 UJ	6 UJ	6 U	5 U
1,2-Dichloroethane	UG/KG	0	0%	100	0	0	177	7 U	6 U	5 U	6 U	6 U	5 U
1,2-Dichloroethene (total)	UG/KG	0	0%		0	0	9						
1,2-Dichloropropane	UG/KG	0	0%		0	0	107	7 U	6 U	5 U	6 U	6 U	5 U
1,3-Dichlorobenzene	UG/KG	0	0%	1600	0	0	161	7 UJ	6 UJ	5 UJ	6 UJ	6 U	5 U
1,3-Dichloropropane	UG/KG	0	0%		0	0	70						
1,4-Dichlorobenzene	UG/KG	0	0%	8500	0	0	161	7 UJ	6 UJ	5 UJ	6 UJ	6 U	5 U
Acetone	UG/KG	550	27%	200	2	47	177	7 U	6 U	50 NJ	69 NJ	6 U	5 U
Benzene	UG/KG	3	4%	60	7	7	177	7 U	6 U	5 U	6 U	6 U	5 U
Bromodichloromethane	UG/KG	0	0%		0	0	107	7 U	6 U	5 U	6 U	6 U	5 U
Bromoform	UG/KG	0	0%		0	0	107	7 UJ	6 U	5 U	6 U	6 U	5 U
Carbon disulfide	UG/KG	4	3%	2700	0	6	177	7 U	6 U	5 U	6 U	6 U	5 U
Carbon tetrachloride	UG/KG	0	0%	600	0	0	177	7 U	6 U	5 U	6 U	6 U	5 U
Chlorobenzene	UG/KG	0	0%	1700	0	0	177	7 UJ	6 U	5 U	6 U	6 U	5 U
Chlorodibromomethane	UG/KG	0	0%		0	0	177	7 UJ	6 U	5 U	6 U	6 U	5 U
Chloroethane	UG/KG	0	0%	1900	0	0	177	7 U	6 U	5 U	6 U	6 U	5 U
Chloroform	UG/KG	0	0%	300	0	0	177	7 U	6 U	5 U	6 U	6 U	5 U
Cis-1,2-Dichloroethene	UG/KG	0	0%		0	0	98	7 U	6 U	5 U	6 U	6 U	5 U
Cis-1,3-Dichloropropene	UG/KG	0	0%		0	0	107	7 U	6 U	5 U	6 U	6 U	5 U
Cyclohexane	UG/KG	3	8%		0	8	98	7 U	6 U	5 U	6 U	6 U	5 U
Dichlorodifluoromethane	UG/KG	0	0%		0	0	98	7 U	6 U	5 U	6 U	6 U	5 U
Ethyl benzene	UG/KG	4.6	1%	5500	0	2	177	7 UJ	6 U	5 U	6 U	6 U	5 U
Isopropylbenzene	UG/KG	0	0%		0	0	98	7 UJ	6 U	5 U	6 U	6 U	5 U
Meta/Para Xylene	UG/KG	9.4	4%		0	3	70						
Methyl Acetate	UG/KG	2	3%		0	3	98	7 U	6 U	5 U	6 U	6 U	5 U
Methyl Tertbutyl Ether	UG/KG	0	0%		0	0	98	7 U	6 U	5 U	6 U	6 U	5 U
Methyl bromide	UG/KG	0	0%		0	0	107	7 U	6 U	5 U	6 U	6 U	5 U
Methyl butyl ketone	UG/KG	0	0%		0	0	107	7 UJ	6 U	5 U	6 U	6 U	5 U
Methyl chloride	UG/KG	0	0%		0	0	107	7 U	6 U	5 U	6 U	6 U	5 U
Methyl cyclohexane	UG/KG	5	10%		0	10	98	7 U	6 U	5 U	6 U	6 U	5 U
Methyl ethyl ketone	UG/KG	190	12%	300	0	22	177	7 U	6 U	5 U	7 J	6 U	5 U
Methyl isobutyl ketone	UG/KG	1.9	1%	1000	0	1	177	7 U	6 U	5 U	6 U	6 U	5 U
Methylene chloride	UG/KG	4.9	20%	100	0	36	178	7 U	6 U	5 U	6 U	6 UJ	5 UJ
Ortho Xylene	UG/KG	5.05	4%		0	3	70						

Table A-2A
SURFACE SOIL SAMPLE RESULTS (0-2 ft.)
SEAD-59
SEAD-59 and SEAD-71 Phase II RI Report
Seneca Army Depot Activity

Facility	SEAD-59	SEAD-59	SEAD-59	SEAD-59	SEAD-59	SEAD-59							
Location ID	CL-59-01-WN3	CL-59-01-WN4	CL-59-01-WN5	CL-59-01-WN6	CL-59-01-WS2	CL-59-01-WS3							
Maxtrix	SOIL	SOIL	SOIL	SOIL	SOIL	SOIL							
Sample ID	CL-59-01-WN3	CL-59-01-WN4	CL-59-01-WN5	CL-59-01-WN6	CL-59-01-WS2	CL-59-01-WS3							
Sample Depth to Top of Sample ⁽¹⁾	0	0	0	0	0	0							
Sample Depth to Bottom of Sample ⁽¹⁾	0	0	0	0	0	0							
Sample Date	5/6/2004	5/6/2004	5/6/2004	5/6/2004	5/6/2004	5/6/2004							
QC Code	SA	SA	SA	SA	SA	SA							
Study ID	ENSR IRM	ENSR IRM	ENSR IRM	ENSR IRM	ENSR IRM	ENSR IRM							
Sample Round	1	1	1	1	1	1							
Parameter	Units	Maximum Value	Frequency of Detection	NYSDEC TAGM 4046 ⁽²⁾	Number of Exceedances	Number of Detects	Number of Analyses ⁽³⁾	Value (Q)	Value (Q)	Value (Q)	Value (Q)	Value (Q)	Value (Q)
Styrene	UG/KG	0	0%		0	0	107	7 UJ	6 U	5 U	6 U	6 U	5 U
Tetrachloroethene	UG/KG	6.4	3%	1400	0	5	177	7 UJ	6 U	5 U	6 U	6 U	5 U
Toluene	UG/KG	8	8%	1500	0	14	177	7 U	6 U	5 U	6 U	6 U	5 U
Total BTEX	MG/KG	3.25	67%		0	2	3						
Total Xylenes	UG/KG	3	7%	1200	0	7	102	7 UJ	6 UJ	5 UJ	6 UJ	6 U	5 U
Trans-1,2-Dichloroethene	UG/KG	0	0%	300	0	0	168	7 U	6 U	5 U	6 U	6 U	5 U
Trans-1,3-Dichloropropene	UG/KG	0	0%		0	0	107	7 U	6 U	5 U	6 U	6 U	5 U
Trichloroethene	UG/KG	4.5	5%	700	0	8	177	7 U	6 U	5 U	6 U	6 U	5 U
Trichlorofluoromethane	UG/KG	6	1%		0	1	98	7 U	6 U	5 U	6 U	6 U	5 U
Vinyl chloride	UG/KG	0	0%	200	0	0	177	7 U	6 U	5 U	6 U	6 U	5 U
Semivolatile Organics													
1,1'-Biphenyl	UG/KG	254.5	2%		0	2	99	470 U	400 U	400 U	370 U	380 U	360 U
1,2,4-Trichlorobenzene	UG/KG	0	0%	3400	0	0	9						
1,2-Dichlorobenzene	UG/KG	0	0%	7900	0	0	9						
1,3-Dichlorobenzene	UG/KG	0	0%	1600	0	0	9						
1,4-Dichlorobenzene	UG/KG	0	0%	8500	0	0	9						
2,2'-oxybis(1-Chloropropane)	UG/KG	0	0%		0	0	105	470 U	400 U	400 U	370 U	380 U	360 U
2,4,5-Trichlorophenol	UG/KG	0	0%	100	0	0	178	1200 U	1000 U	1000 U	940 U	960 U	920 U
2,4,6-Trichlorophenol	UG/KG	0	0%		0	0	178	470 U	400 U	400 U	370 U	380 U	360 U
2,4-Dichlorophenol	UG/KG	0	0%	400	0	0	178	470 U	400 U	400 U	370 U	380 U	360 U
2,4-Dimethylphenol	UG/KG	0	0%		0	0	108	470 U	400 U	400 U	370 U	380 U	360 U
2,4-Dinitrophenol	UG/KG	0	0%	200	0	0	178	1200 U	1000 U	1000 U	940 U	960 U	920 U
2,4-Dinitrotoluene	UG/KG	0	0%		0	0	178	470 U	400 U	400 U	370 U	380 U	360 U
2,6-Dinitrotoluene	UG/KG	0	0%	1000	0	0	178	470 U	400 U	400 U	370 U	380 U	360 U
2-Chloronaphthalene	UG/KG	0	0%		0	0	108	470 U	400 U	400 U	370 U	380 U	360 U
2-Chlorophenol	UG/KG	0	0%	800	0	0	178	470 U	400 U	400 U	370 U	380 U	360 U
2-Methylnaphthalene	UG/KG	1295	19%	36400	0	34	178	130 J	250 J	400 U	370 U	380 U	360 U
2-Methylphenol	UG/KG	0	0%	100	0	0	178	470 U	400 U	400 U	370 U	380 U	360 U
2-Nitroaniline	UG/KG	0	0%	430	0	0	178	1200 U	1000 U	1000 U	940 U	960 U	920 U
2-Nitrophenol	UG/KG	0	0%	330	0	0	178	470 U	400 U	400 U	370 U	380 U	360 U
3,3'-Dichlorobenzidine	UG/KG	0	0%		0	0	178	470 U	400 U	400 U	370 U	380 U	360 U
3-Nitroaniline	UG/KG	0	0%	500	0	0	178	1200 U	1000 U	1000 U	940 U	960 U	920 U
4,6-Dinitro-2-methylphenol	UG/KG	0	0%		0	0	108	1200 U	1000 U	1000 U	940 U	960 U	920 U
4-Bromophenyl phenyl ether	UG/KG	0	0%		0	0	108	470 U	400 U	400 U	370 U	380 U	360 U
4-Chloro-3-methylphenol	UG/KG	0	0%	240	0	0	178	470 U	400 U	400 U	370 U	380 U	360 U
4-Chloroaniline	UG/KG	1200	1%	220	1	2	178	130 J	400 U	400 U	370 U	380 U	360 U
4-Chlorophenyl phenyl ether	UG/KG	0	0%		0	0	108	470 U	400 U	400 U	370 U	380 U	360 U
4-Methylphenol	UG/KG	150	3%	900	0	5	178	470 U	400 U	150 J	370 U	380 U	360 U
4-Nitroaniline	UG/KG	0	0%		0	0	108	1200 U	1000 U	1000 U	940 U	960 U	920 U
4-Nitrophenol	UG/KG	0	0%	100	0	0	178	1200 U	1000 U	1000 U	940 U	960 U	920 U
Acenaphthene	UG/KG	2680	24%	50000	0	42	178	470 U	130 J	400 U	370 U	380 U	360 U
Acenaphthylene	UG/KG	1700	37%	41000	0	66	178	160 J	160 J	400 U	39 J	380 U	360 U
Acetophenone	UG/KG	0	0%		0	0	99	470 U	400 U	400 U	370 U	380 U	360 U
Aniline	UG/KG	0	0%		0	0	70						
Anthracene	UG/KG	4395	43%	50000	0	77	178	190 J	330 J	400 U	370 U	380 U	360 U

Table A-2A
SURFACE SOIL SAMPLE RESULTS (0-2 ft.)
SEAD-59
SEAD-59 and SEAD-71 Phase II RI Report
Seneca Army Depot Activity

Facility	SEAD-59	SEAD-59	SEAD-59	SEAD-59	SEAD-59	SEAD-59							
Location ID	CL-59-01-WN3	CL-59-01-WN4	CL-59-01-WN5	CL-59-01-WN6	CL-59-01-WN2	CL-59-01-WN3							
Maxtrix	SOIL	SOIL	SOIL	SOIL	SOIL	SOIL							
Sample ID	CL-59-01-WN3	CL-59-01-WN4	CL-59-01-WN5	CL-59-01-WN6	CL-59-01-WN2	CL-59-01-WN3							
Sample Depth to Top of Sample ⁽¹⁾	0	0	0	0	0	0							
Sample Depth to Bottom of Sample ⁽¹⁾	0	0	0	0	0	0							
Sample Date	5/6/2004	5/6/2004	5/6/2004	5/6/2004	5/6/2004	5/6/2004							
QC Code	SA	SA	SA	SA	SA	SA							
Study ID	ENSR IRM	ENSR IRM	ENSR IRM	ENSR IRM	ENSR IRM	ENSR IRM							
Sample Round	1	1	1	1	1	1							
Parameter	Units	Maximum Value	Frequency of Detection	NYSDEC TAGM 4046 ⁽²⁾	Number of Exceedances	Number of Detects	Number of Analyses ⁽³⁾	Value (Q)	Value (Q)	Value (Q)	Value (Q)	Value (Q)	Value (Q)
Atrazine	UG/KG	120	1%		0	1	99	470 U	400 U	400 U	370 U	380 U	360 U
Benzaldehyde	UG/KG	50	1%		0	1	99	470 U	400 U	400 U	370 U	380 U	360 U
Benzo(a)anthracene	UG/KG	8900	51%	224	72	90	178	670 NJ	600 NJ	62 NJ	170 NJ	380 U	360 U
Benzo(a)pyrene	UG/KG	8050	51%	61	84	91	178	620	640	53 J	240 J	380 U	360 U
Benzo(b)fluoranthene	UG/KG	6800	52%	1100	40	92	178	1000	720	67 J	300 J	380 U	360 U
Benzo(ghi)perylene	UG/KG	5200	46%	50000	0	82	178	260 J	360 J	400 U	170 J	380 U	360 U
Benzo(k)fluoranthene	UG/KG	7350	49%	1100	35	88	178	370 J	310 J	400 U	120 J	380 U	360 U
Benzoic Acid	UG/KG	0	0%	2700	0	0	70						
Bis(2-Chloroethoxy)methane	UG/KG	0	0%		0	0	108	470 U	400 U	400 U	370 U	380 U	360 U
Bis(2-Chloroethyl)ether	UG/KG	0	0%		0	0	108	470 U	400 U	400 U	370 U	380 U	360 U
Bis(2-Chloroisopropyl)ether	UG/KG	0	0%		0	0	3						
Bis(2-Ethylhexyl)phthalate	UG/KG	990	19%	50000	0	34	178	55 J	41 J	400 U	370 U	380 U	360 U
Butylbenzylphthalate	UG/KG	0	0%	50000	0	0	178	470 U	400 U	400 U	370 U	380 U	360 U
Caprolactam	UG/KG	0	0%		0	0	99	470 U	400 U	400 U	370 U	380 U	360 U
Carbazole	UG/KG	755	19%		0	20	108	470 U	140 J	400 U	370 U	380 U	360 U
Chrysene	UG/KG	8900	51%	400	62	91	178	700	590	60 J	180 J	380 U	360 U
Di-n-butylphthalate	UG/KG	965	2%	8100	0	4	178	470 U	400 U	400 U	370 U	380 U	360 U
Di-n-octylphthalate	UG/KG	0	0%	50000	0	0	178	470 U	400 U	400 U	370 U	380 U	360 U
Dibenz(a,h)anthracene	UG/KG	1665	38%	14	67	68	178	89 J	99 J	400 U	38 J	380 U	360 U
Dibenzofuran	UG/KG	2350	16%	6200	0	28	178	470 U	120 J	400 U	370 U	380 U	360 U
Diethyl phthalate	UG/KG	10	1%	7100	0	1	178	470 U	400 U	400 U	370 U	380 U	360 U
Dimethylphthalate	UG/KG	0	0%	2000	0	0	178	470 U	400 U	400 U	370 U	380 U	360 U
Fluoranthene	UG/KG	23500	54%	50000	0	97	178	1000	1100	130 J	240 J	380 U	360 U
Fluorene	UG/KG	2640	28%	50000	0	49	178	470 U	220 J	400 U	370 U	380 U	360 U
Hexachlorobenzene	UG/KG	0	0%	410	0	0	178	470 U	400 U	400 U	370 U	380 U	360 U
Hexachlorobutadiene	UG/KG	0	0%		0	0	178	470 U	400 U	400 U	370 U	380 U	360 U
Hexachlorocyclopentadiene	UG/KG	0	0%		0	0	108	470 U	400 U	400 U	370 U	380 U	360 U
Hexachloroethane	UG/KG	0	0%		0	0	178	470 U	400 U	400 U	370 U	380 U	360 U
Indeno(1,2,3-cd)pyrene	UG/KG	4950	47%	3200	2	84	178	340 J	390 J	400 U	170 J	380 U	360 U
Isophorone	UG/KG	0	0%	4400	0	0	178	470 U	400 U	400 U	370 U	380 U	360 U
N-Nitrosodiphenylamine	UG/KG	100	1%		0	1	108	470 U	400 U	400 U	370 U	380 U	360 U
N-Nitrosodipropylamine	UG/KG	0	0%		0	0	108	470 U	400 U	400 U	370 U	380 U	360 U
Naphthalene	UG/KG	1800	19%	13000	0	34	178	88 J	180 J	400 U	370 U	380 U	360 U
Nitrobenzene	UG/KG	0	0%	200	0	0	178	470 U	400 U	400 U	370 U	380 U	360 U
Pentachlorophenol	UG/KG	0	0%	1000	0	0	178	1200 U	1000 U	1000 U	940 U	960 U	920 U
Phenanthrene	UG/KG	21300	51%	50000	0	90	178	230 J	1300	140 J	72 J	380 U	360 U
Phenol	UG/KG	0	0%	30	0	0	178	470 U	400 U	400 U	370 U	380 U	360 U
Pyrene	UG/KG	19200	55%	50000	0	98	178	1100	1100	100 J	240 J	380 U	360 U
Pyridine	UG/KG	0	0%		0	0	100					380 U	360 U
Total Unknown PAHs as SV	MG/KG	25	100%		0	3	3						
Pesticides/PCBs													
4,4'-DDD	UG/KG	740	28%	2900	0	49	178	340 J	5.5 J	4 U	3.8 U	3.8 U	3.6 U
4,4'-DDE	UG/KG	2600	37%	2100	1	65	178	760	26	14 J	15	3.8 U	3.6 U
4,4'-DDT	UG/KG	3700	33%	2100	1	59	178	1200	22	4 U	3.8 U	3.8 U	3.6 U
Aldrin	UG/KG	1.2	1%	41	0	1	178	48 U	2.1 U	2 U	1.9 U	2 U	1.9 U

**Table A-2A
SURFACE SOIL SAMPLE RESULTS (0-2 ft.)
SEAD-59
SEAD-59 and SEAD-71 Phase II RI Report
Seneca Army Depot Activity**

Facility	SEAD-59						SEAD-59						
Location ID	CL-59-01-WN3		CL-59-01-WN4		CL-59-01-WN5		CL-59-01-WN6		CL-59-01-WN2		CL-59-01-WN3		
Maxtrix	SOIL						SOIL						
Sample ID	CL-59-01-WN3		CL-59-01-WN4		CL-59-01-WN5		CL-59-01-WN6		CL-59-01-WN2		CL-59-01-WN3		
Sample Depth to Top of Sample ⁽¹⁾	0						0						
Sample Depth to Bottom of Sample ⁽¹⁾	0						0						
Sample Date	5/6/2004		5/6/2004		5/6/2004		5/6/2004		5/6/2004		5/6/2004		
QC Code	SA		SA		SA		SA		SA		SA		
Study ID	ENSR IRM		ENSR IRM		ENSR IRM		ENSR IRM		ENSR IRM		ENSR IRM		
Sample Round	1		1		1		1		1		1		
Parameter	Units	Maximum Value	Frequency of Detection	NYSDEC TAGM 4046 ⁽²⁾	Number of Exceedances	Number of Detects	Number of Analyses ⁽³⁾	Value (Q)	Value (Q)	Value (Q)	Value (Q)	Value (Q)	Value (Q)
Alpha-BHC	UG/KG	0	0%	110	0	0	178	48 U	2.1 U	2 U	1.9 U	2 U	1.9 U
Alpha-Chlordane	UG/KG	34	4%		0	7	178	48 U	2.1 U	2 U	1.9 U	2 U	1.9 U
Beta-BHC	UG/KG	2.4	1%	200	0	1	178	48 U	2.1 U	2 U	1.9 U	2 U	1.9 U
Delta-BHC	UG/KG	0	0%	300	0	0	178	48 U	2.1 U	2 U	1.9 U	2 U	1.9 U
Dieldrin	UG/KG	0	0%	44	0	0	178	94 U	4 U	4 U	3.8 U	3.8 U	3.6 U
Endosulfan I	UG/KG	16	1%	900	0	1	178	48 U	2.1 U	2 U	1.9 U	2 U	1.9 U
Endosulfan II	UG/KG	0	0%	900	0	0	178	94 U	4 U	4 U	3.8 U	3.8 U	3.6 U
Endosulfan sulfate	UG/KG	6.2	1%	1000	0	1	178	94 U	4 U	4 U	3.8 U	3.8 U	3.6 U
Endrin	UG/KG	16	2%	100	0	3	178	94 U	4 U	4 U	3.8 U	3.8 U	3.6 U
Endrin aldehyde	UG/KG	4.9	1%		0	2	178	94 U	4 U	4 U	3.8 U	3.8 U	3.6 U
Endrin ketone	UG/KG	38	2%		0	4	178	94 U	4 U	4 U	3.8 U	3.8 U	3.6 U
Gamma-BHC/Lindane	UG/KG	0	0%	60	0	0	178	48 U	2.1 U	2 U	1.9 U	2 U	1.9 U
Gamma-Chlordane	UG/KG	24	8%	540	0	14	178	48 U	2.1 U	2 U	1.9 U	2 U	1.9 U
Heptachlor	UG/KG	0	0%	100	0	0	178	48 U	2.1 U	2 U	1.9 U	2 U	1.9 U
Heptachlor epoxide	UG/KG	3	1%	20	0	2	178	48 U	2.1 U	2 U	1.9 U	2 U	1.9 U
Methoxychlor	UG/KG	0	0%		0	0	178	480 U	21 U	20 U	19 U	20 U	19 U
Toxaphene	UG/KG	0	0%		0	0	178	4800 U	210 U	200 U	190 U	200 U	190 U
Aroclor-1016	UG/KG	0	0%		0	0	178	47 U	41 U	40 U	38 U	38 U	37 U
Aroclor-1221	UG/KG	0	0%		0	0	178	47 U	41 U	40 U	38 U	38 U	37 U
Aroclor-1232	UG/KG	0	0%		0	0	178	47 U	41 U	40 U	38 U	38 U	37 U
Aroclor-1242	UG/KG	0	0%		0	0	178	47 U	41 U	40 U	38 U	38 U	37 U
Aroclor-1248	UG/KG	0	0%		0	0	178	47 U	41 U	40 U	38 U	38 U	37 U
Aroclor-1254	UG/KG	0	0%	10000	0	0	178	47 U	41 U	40 U	38 U	38 U	37 U
Aroclor-1260	UG/KG	79	1%	10000	0	2	178	47 U	41 U	40 U	38 U	38 U	37 U
Metals													
Aluminum	MG/KG	18300	100%	19300	0	178	178	12400 J	13500 J	13800 J	7700 J	10400 J	5520 J
Antimony	MG/KG	424	58%	5.9	5	104	178	3.9 J	1.6 J	1.7 J	1.3 J	1.6 J	0.8 J
Arsenic	MG/KG	32.2	100%	8.2	7	178	178	16.7 J	6.3 J	4.7 J	4.7 J	6 J	2.6 J
Barium	MG/KG	304	100%	300	1	178	178	83.3 J	127 J	138 J	62.8 J	84.1 J	50.2 J
Beryllium	MG/KG	2.6	99%	1.1	2	176	178	1.4 J	0.89	0.73	0.41	0.49	0.23 J
Cadmium	MG/KG	3.2	86%	2.3	2	153	178	1.6 J	0.54	0.39	0.29 J	0.51	0.28 J
Calcium	MG/KG	21400	100%	121000	1	178	178	22700 J	5020 J	3020 J	119000 J	11100 J	86000 J
Chromium	MG/KG	39.3	100%	29.6	2	178	178	33.6 J	16.9 J	22.3 J	11.7 J	14.8 J	7.6 J
Cobalt	MG/KG	47.8	100%	30	2	178	178	30.4 J	9.4 J	9.1 J	7.9 J	8.3 J	3.9 J
Copper	MG/KG	305	100%	33	19	178	178	96.7 J	22.6 J	27.4 J	17.9 J	24.4 J	13.4 J
Cyanide	MG/KG	0	0%	0.35	0	0	9						
Iron	MG/KG	64000	100%	36500	1	178	178	32700 J	19400 J	24600 J	17000 J	19600 J	9350 J
Lead	MG/KG	164	100%	24.8	75	178	178	108 J	81.5 J	13.3 J	9.3 J	9.9 J	4.1 J
Magnesium	MG/KG	30200	100%	21500	3	178	178	7370 J	3080 J	5140 J	7890 J	4980 J	30200 J
Manganese	MG/KG	1290	100%	1060	3	178	178	595 J	600 J	620 J	360 J	371 J	350 J
Mercury	MG/KG	0.95	95%	0.1	37	169	178	0.1	0.1	0.03 J	0.02 J	0.02 U	0.02 U
Nickel	MG/KG	88.3	100%	49	3	178	178	57.2 J	23.9 J	30 J	21.5 J	23.9 J	9 J
Potassium	MG/KG	2290	100%	2380	0	178	178	1460 J	1160 J	1120 J	937 J	1110 J	1380 J
Selenium	MG/KG	1.5	9%	2	0	16	178	0.46 U	0.77 J	0.42 U	0.4 U	0.38 U	0.39 U
Silver	MG/KG	2.9	49%	0.75	62	87	178	1.3 J	1 J	1.2 J	0.1 U	0.48 J	0.1 U
Sodium	MG/KG	4060	99%	172	86	177	178	224 J	50.8 J	514 J	209 J	114 J	418 J

**Table A-2A
SURFACE SOIL SAMPLE RESULTS (0-2 ft.)
SEAD-59
SEAD-59 and SEAD-71 Phase II RI Report
Seneca Army Depot Activity**

				SEAD-59	SEAD-59	SEAD-59	SEAD-59	SEAD-59	SEAD-59	SEAD-59	SEAD-59		
				CL-59-01-WN3	CL-59-01-WN4	CL-59-01-WN5	CL-59-01-WN6	CL-59-01-WN2	CL-59-01-WN3	CL-59-01-WN2	CL-59-01-WN3		
				SOIL	SOIL	SOIL	SOIL	SOIL	SOIL	SOIL	SOIL		
				CL-59-01-WN3	CL-59-01-WN4	CL-59-01-WN5	CL-59-01-WN6	CL-59-01-WN2	CL-59-01-WN3	CL-59-01-WN2	CL-59-01-WN3		
Sample Depth to Top of Sample ⁽¹⁾				0	0	0	0	0	0	0	0		
Sample Depth to Bottom of Sample ⁽¹⁾				0	0	0	0	0	0	0	0		
Sample Date				5/6/2004	5/6/2004	5/6/2004	5/6/2004	5/6/2004	5/6/2004	5/6/2004	5/6/2004		
QC Code				SA	SA	SA	SA	SA	SA	SA	SA		
Study ID				ENSR IRM	ENSR IRM	ENSR IRM	ENSR IRM	ENSR IRM	ENSR IRM	ENSR IRM	ENSR IRM		
Sample Round				1	1	1	1	1	1	1	1		
Parameter	Units	Maximum Value	Frequency of Detection	NYSDEC TAGM 4046 ⁽²⁾	Number of Exceedances	Number of Detects	Number of Analyses ⁽³⁾	Value (Q)	Value (Q)	Value (Q)	Value (Q)	Value (Q)	Value (Q)
Thallium	MG/KG	1.8	29%	0.7	24	51	178	0.23 U	0.22 U	0.21 U	0.2 U	0.19 U	0.3 J
Vanadium	MG/KG	28.5	100%	150	0	178	178	24.8 J	20.7 J	23.3 J	12.9 J	20.7 J	11.6 J
Zinc	MG/KG	341	100%	110	19	178	178	233 J	73.6 J	63.3 J	37.3 J	45.1 J	20.3 J

Note(s):

(1) - Historical sample depths are presented (I.e. prior to 2002 TCRA)

(2) - NYSDEC Technical and Administrative Guidance Memorandum (TAGM) HWR-94-4046, Revised January 24, 1994

(3) - Sample/Duplicate pair are presented as individual samples in this table. Statistical information used Sample Duplicate pairs as a single entity and averaged result values were used in risk assessment analysis.

U = compound was not detected

J = the reported value is an estimated concentration

UJ = the compound was not detected; the associated reporting limit is approximate

R = the data was rejected in the data validating process

NJ = compound was "tentatively identified" and the associated numerical value is approximate

Table A-2A
SURFACE SOIL SAMPLE RESULTS (0-2 ft.)
SEAD-59
SEAD-59 and SEAD-71 Phase II RI Report
Seneca Army Depot Activity

Facility	SEAD-59						SEAD-59						
Location ID	CL-59-01-WS4		CL-59-01-WS5		CL-59-01-WS6		CL-59-01-WW1		CL-59-01-WW2		CL-59-01-WW3		
Maxtrix	SOIL						SOIL						
Sample ID	CL-59-01-WS4		CL-59-01-WS5		CL-59-01-WS6		CL-59-01-WW1		CL-59-01-WW2		CL-59-01-WW3		
Sample Depth to Top of Sample ⁽¹⁾	0						0						
Sample Depth to Bottom of Sample ⁽¹⁾	0						0						
Sample Date	5/6/2004		5/6/2004		5/6/2004		5/6/2004		5/6/2004		5/6/2004		
QC Code	SA		SA		SA		SA		SA		SA		
Study ID	ENSR IRM		ENSR IRM		ENSR IRM		ENSR IRM		ENSR IRM		ENSR IRM		
Sample Round	1		1		1		1		1		1		
Parameter	Units	Maximum Value	Frequency of Detection	NYSDEC TAGM 4046 ⁽²⁾	Number of Exceedances	Number of Detects	Number of Analyses ⁽³⁾	Value (Q)	Value (Q)	Value (Q)	Value (Q)	Value (Q)	Value (Q)
Volatile Organics													
1,1,1-Trichloroethane	UG/KG	0	0%	800	0	0	177	6 U	6 U	6 U	6 UJ	5 U	5 U
1,1,2,2-Tetrachloroethane	UG/KG	0	0%	600	0	0	169	6 U	6 R	6 UJ	6 R	5 UJ	5 U
1,1,2-Trichloro-1,2,2-Trifluoroethane	UG/KG	0	0%		0	0	168	6 U	6 U	6 U	6 UJ	5 U	5 U
1,1,2-Trichloroethane	UG/KG	0	0%		0	0	107	6 U	6 U	6 U	6 UJ	5 U	5 U
1,1-Dichloroethane	UG/KG	0	0%	200	0	0	177	6 U	6 U	6 U	6 UJ	5 U	5 U
1,1-Dichloroethene	UG/KG	8	2%	400	0	3	177	2 J	8 J	6 U	6 UJ	5 U	5 U
1,2,3-Trichloropropane	UG/KG	0	0%		0	0	70						
1,2,4-Trichlorobenzene	UG/KG	0	0%	3400	0	0	161	6 U	6 R	6 UJ	6 R	5 UJ	5 U
1,2-Dibromo-3-chloropropane	UG/KG	0	0%		0	0	91	6 U	6 R	6 UJ	6 R	5 UJ	5 U
1,2-Dibromoethane	UG/KG	0	0%		0	0	98	6 U	6 U	6 U	6 UJ	5 U	5 U
1,2-Dichlorobenzene	UG/KG	0	0%	7900	0	0	161	6 U	6 R	6 UJ	6 R	5 UJ	5 U
1,2-Dichloroethane	UG/KG	0	0%	100	0	0	177	6 U	6 U	6 U	6 UJ	5 U	5 U
1,2-Dichloroethene (total)	UG/KG	0	0%		0	0	9						
1,2-Dichloropropane	UG/KG	0	0%		0	0	107	6 U	6 U	6 U	6 UJ	5 U	5 U
1,3-Dichlorobenzene	UG/KG	0	0%	1600	0	0	161	6 U	6 R	6 UJ	6 R	5 UJ	5 U
1,3-Dichloropropane	UG/KG	0	0%		0	0	70						
1,4-Dichlorobenzene	UG/KG	0	0%	8500	0	0	161	6 U	6 R	6 UJ	6 R	5 UJ	5 U
Acetone	UG/KG	550	27%	200	2	47	177	36 NJ	6 U	11 NJ	14 J	46	5 U
Benzene	UG/KG	3	4%	60	7	7	177	6 U	6 U	6 U	6 UJ	5 U	5 U
Bromodichloromethane	UG/KG	0	0%		0	0	107	6 U	6 U	6 U	6 UJ	5 U	5 U
Bromoform	UG/KG	0	0%		0	0	107	6 U	6 U	6 U	6 UJ	5 U	5 U
Carbon disulfide	UG/KG	4	3%	2700	0	6	177	6 U	6 U	6 U	6 UJ	5 U	5 U
Carbon tetrachloride	UG/KG	0	0%	600	0	0	177	6 U	6 U	6 U	6 UJ	5 U	5 U
Chlorobenzene	UG/KG	0	0%	1700	0	0	177	6 U	6 U	6 U	6 UJ	5 U	5 U
Chlorodibromomethane	UG/KG	0	0%		0	0	177	6 U	6 U	6 U	6 UJ	5 U	5 U
Chloroethane	UG/KG	0	0%	1900	0	0	177	6 U	6 U	6 U	6 UJ	5 U	5 U
Chloroform	UG/KG	0	0%	300	0	0	177	6 U	6 U	6 U	6 UJ	5 U	5 U
Cis-1,2-Dichloroethene	UG/KG	0	0%		0	0	98	6 U	6 U	6 U	6 UJ	5 U	5 U
Cis-1,3-Dichloropropene	UG/KG	0	0%		0	0	107	6 U	6 U	6 U	6 UJ	5 U	5 U
Cyclohexane	UG/KG	3	8%		0	8	98	6 U	6 U	6 U	6 UJ	5 U	5 U
Dichlorodifluoromethane	UG/KG	0	0%		0	0	98	6 U	6 U	6 U	6 UJ	5 UJ	5 U
Ethyl benzene	UG/KG	4.6	1%	5500	0	2	177	6 U	6 U	6 U	6 UJ	5 U	5 U
Isopropylbenzene	UG/KG	0	0%		0	0	98	6 U	6 U	6 U	6 UJ	5 U	5 U
Meta/Para Xylene	UG/KG	9.4	4%		0	3	70						
Methyl Acetate	UG/KG	2	3%		0	3	98	6 U	6 U	6 U	6 UJ	5 U	5 U
Methyl Tertbutyl Ether	UG/KG	0	0%		0	0	98	6 U	6 U	6 UJ	6 UJ	5 U	5 U
Methyl bromide	UG/KG	0	0%		0	0	107	6 U	6 U	6 UJ	6 UJ	5 U	5 U
Methyl butyl ketone	UG/KG	0	0%		0	0	107	6 U	6 U	6 UJ	6 UJ	5 U	5 U
Methyl chloride	UG/KG	0	0%		0	0	107	6 U	6 U	6 U	6 UJ	5 U	5 U
Methyl cyclohexane	UG/KG	5	10%		0	10	98	6 U	6 U	6 U	6 UJ	5 U	5 U
Methyl ethyl ketone	UG/KG	190	12%	300	0	22	177	6 U	6 U	6 U	6 UJ	5 U	5 U
Methyl isobutyl ketone	UG/KG	1.9	1%	1000	0	1	177	6 U	6 U	6 UJ	6 UJ	5 U	5 U
Methylene chloride	UG/KG	4.9	20%	100	0	36	178	6 UJ	6 UJ	6 UJ	6 UJ	11 U	5 U
Ortho Xylene	UG/KG	5.05	4%		0	3	70						

Table A-2A
SURFACE SOIL SAMPLE RESULTS (0-2 ft.)
SEAD-59
SEAD-59 and SEAD-71 Phase II RI Report
Seneca Army Depot Activity

Facility	SEAD-59						SEAD-59	SEAD-59	SEAD-59	SEAD-59	SEAD-59	SEAD-59	
Location ID	CL-59-01-WS4						CL-59-01-WS5	CL-59-01-WS6	CL-59-01-WW1	CL-59-01-WW2	CL-59-01-WW3	CL-59-01-WW3	
Maxtrix	SOIL						SOIL	SOIL	SOIL	SOIL	SOIL	SOIL	
Sample ID	CL-59-01-WS4						CL-59-01-WS5	CL-59-01-WS6	CL-59-01-WW1	CL-59-01-WW2	CL-59-01-WW3	CL-59-01-WW3	
Sample Depth to Top of Sample ⁽¹⁾	0						0	0	0	0	0	0	
Sample Depth to Bottom of Sample ⁽¹⁾	0						0	0	0	0	0	0	
Sample Date	5/6/2004						5/6/2004	5/6/2004	5/6/2004	5/6/2004	5/6/2004	5/6/2004	
QC Code	SA						SA	SA	SA	SA	SA	SA	
Study ID	ENSR IRM						ENSR IRM	ENSR IRM	ENSR IRM	ENSR IRM	ENSR IRM	ENSR IRM	
Sample Round	1						1	1	1	1	1	1	
Parameter	Units	Maximum Value	Frequency of Detection	NYSDEC TAGM 4046 ⁽²⁾	Number of Exceedances	Number of Detects	Number of Analyses ⁽³⁾	Value (Q)	Value (Q)	Value (Q)	Value (Q)	Value (Q)	Value (Q)
Styrene	UG/KG	0	0%		0	0	107	6 U	6 U	6 U	6 UJ	5 U	5 U
Tetrachloroethene	UG/KG	6.4	3%	1400	0	5	177	6 U	6 U	6 U	6 UJ	5 U	5 U
Toluene	UG/KG	8	8%	1500	0	14	177	6 U	6 U	6 U	6 UJ	5 U	5 U
Total BTEX	MG/KG	3.25	67%		0	2	3						
Total Xylenes	UG/KG	3	7%	1200	0	7	102	6 U	6 R	6 UJ	6 R	5 UJ	5 U
Trans-1,2-Dichloroethene	UG/KG	0	0%	300	0	0	168	6 U	6 U	6 U	6 UJ	5 U	5 U
Trans-1,3-Dichloropropene	UG/KG	0	0%		0	0	107	6 U	6 U	6 U	6 UJ	5 U	5 U
Trichloroethene	UG/KG	4.5	5%	700	0	8	177	6 U	6 U	6 U	6 UJ	5 U	5 U
Trichlorofluoromethane	UG/KG	6	1%		0	1	98	6 U	6 U	6 U	6 UJ	5 U	5 U
Vinyl chloride	UG/KG	0	0%	200	0	0	177	6 U	6 U	6 U	6 UJ	5 U	5 U
Semivolatile Organics													
1,1'-Biphenyl	UG/KG	254.5	2%		0	2	99	380 U	390 U	380 U	390 U	380 U	370 U
1,2,4-Trichlorobenzene	UG/KG	0	0%	3400	0	0	9						
1,2-Dichlorobenzene	UG/KG	0	0%	7900	0	0	9						
1,3-Dichlorobenzene	UG/KG	0	0%	1600	0	0	9						
1,4-Dichlorobenzene	UG/KG	0	0%	8500	0	0	9						
2,2'-oxybis(1-Chloropropane)	UG/KG	0	0%		0	0	105	380 U	390 U	380 U	390 U	380 U	370 U
2,4,5-Trichlorophenol	UG/KG	0	0%	100	0	0	178	970 U	990 U	960 U	980 U	960 U	920 U
2,4,6-Trichlorophenol	UG/KG	0	0%		0	0	178	380 U	390 U	380 U	390 U	380 U	370 U
2,4-Dichlorophenol	UG/KG	0	0%	400	0	0	178	380 U	390 U	380 U	390 U	380 U	370 U
2,4-Dimethylphenol	UG/KG	0	0%		0	0	108	380 U	390 U	380 U	390 U	380 U	370 U
2,4-Dinitrophenol	UG/KG	0	0%	200	0	0	178	970 U	990 U	960 U	980 U	960 U	920 U
2,4-Dinitrotoluene	UG/KG	0	0%		0	0	178	380 U	390 U	380 U	390 U	380 U	370 U
2,6-Dinitrotoluene	UG/KG	0	0%	1000	0	0	178	380 U	390 U	380 U	390 U	380 U	370 U
2-Chloronaphthalene	UG/KG	0	0%		0	0	108	380 U	390 U	380 U	390 U	380 U	370 U
2-Chlorophenol	UG/KG	0	0%	800	0	0	178	380 U	390 U	380 U	390 U	380 U	370 U
2-Methylnaphthalene	UG/KG	1295	19%	36400	0	34	178	82 NJ	120 J	380 U	390 U	380 U	370 U
2-Methylphenol	UG/KG	0	0%	100	0	0	178	380 U	390 U	380 U	390 U	380 U	370 U
2-Nitroaniline	UG/KG	0	0%	430	0	0	178	970 U	990 U	960 U	980 U	960 U	920 U
2-Nitrophenol	UG/KG	0	0%	330	0	0	178	380 U	390 U	380 U	390 U	380 U	370 U
3,3'-Dichlorobenzidine	UG/KG	0	0%		0	0	178	380 U	390 U	380 U	390 U	380 U	370 U
3-Nitroaniline	UG/KG	0	0%	500	0	0	178	970 U	990 U	960 U	980 U	960 U	920 U
4,6-Dinitro-2-methylphenol	UG/KG	0	0%		0	0	108	970 U	990 U	960 U	980 U	960 U	920 U
4-Bromophenyl phenyl ether	UG/KG	0	0%		0	0	108	380 U	390 U	380 U	390 U	380 U	370 U
4-Chloro-3-methylphenol	UG/KG	0	0%	240	0	0	178	380 U	390 U	380 U	390 U	380 U	370 U
4-Chloroaniline	UG/KG	1200	1%	220	1	2	178	380 U	390 U	380 U	390 U	380 U	370 U
4-Chlorophenyl phenyl ether	UG/KG	0	0%		0	0	108	380 U	390 U	380 U	390 U	380 U	370 U
4-Methylphenol	UG/KG	150	3%	900	0	5	178	380 U	390 U	380 U	390 U	380 U	370 U
4-Nitroaniline	UG/KG	0	0%		0	0	108	970 U	990 U	960 U	980 U	960 U	920 U
4-Nitrophenol	UG/KG	0	0%	100	0	0	178	970 U	990 U	960 U	980 U	960 U	920 U
Acenaphthene	UG/KG	2680	24%	50000	0	42	178	380 U	64 J	380 U	390 U	380 U	370 U
Acenaphthylene	UG/KG	1700	37%	41000	0	66	178	380 U	390 U	380 U	390 U	380 U	370 U
Acetophenone	UG/KG	0	0%		0	0	99	380 U	390 U	380 U	390 U	380 U	370 U
Aniline	UG/KG	0	0%		0	0	70						
Anthracene	UG/KG	4395	43%	50000	0	77	178	47 J	120 J	380 U	390 U	380 U	370 U

**Table A-2A
SURFACE SOIL SAMPLE RESULTS (0-2 ft.)
SEAD-59
SEAD-59 and SEAD-71 Phase II RI Report
Seneca Army Depot Activity**

Facility	SEAD-59	SEAD-59	SEAD-59	SEAD-59	SEAD-59	SEAD-59							
Location ID	CL-59-01-WS4	CL-59-01-WS5	CL-59-01-WS6	CL-59-01-WW1	CL-59-01-WW2	CL-59-01-WW3							
Maxtrix	SOIL	SOIL	SOIL	SOIL	SOIL	SOIL							
Sample ID	CL-59-01-WS4	CL-59-01-WS5	CL-59-01-WS6	CL-59-01-WW1	CL-59-01-WW2	CL-59-01-WW3							
Sample Depth to Top of Sample ⁽¹⁾	0	0	0	0	0	0							
Sample Depth to Bottom of Sample ⁽¹⁾	0	0	0	0	0	0							
Sample Date	5/6/2004	5/6/2004	5/6/2004	5/6/2004	5/6/2004	5/6/2004							
QC Code	SA	SA	SA	SA	SA	SA							
Study ID	ENSR IRM	ENSR IRM	ENSR IRM	ENSR IRM	ENSR IRM	ENSR IRM							
Sample Round	1	1	1	1	1	1							
Parameter	Units	Maximum Value	Frequency of Detection	NYSDEC TAGM 4046 ⁽²⁾	Number of Exceedances	Number of Detects	Number of Analyses ⁽³⁾	Value (Q)	Value (Q)	Value (Q)	Value (Q)	Value (Q)	Value (Q)
Atrazine	UG/KG	120	1%		0	1	99	380 U	390 U	380 U	390 U	380 U	370 U
Benzaldehyde	UG/KG	50	1%		0	1	99	380 U	390 U	380 U	390 U	380 U	370 U
Benzo(a)anthracene	UG/KG	8900	51%	224	72	90	178	380 U	360 J	380 U	390 U	380 U	370 U
Benzo(a)pyrene	UG/KG	8050	51%	61	84	91	178	380 U	360 J	380 U	390 U	380 U	370 U
Benzo(b)fluoranthene	UG/KG	6800	52%	1100	40	92	178	380 U	510	380 U	390 U	380 U	370 U
Benzo(ghi)perylene	UG/KG	5200	46%	50000	0	82	178	380 U	190 J	380 U	390 U	380 U	370 U
Benzo(k)fluoranthene	UG/KG	7350	49%	1100	35	88	178	380 U	200 J	380 U	390 U	380 U	370 U
Benzoic Acid	UG/KG	0	0%	2700	0	0	70						
Bis(2-Chloroethoxy)methane	UG/KG	0	0%		0	0	108	380 U	390 U	380 U	390 U	380 U	370 U
Bis(2-Chloroethyl)ether	UG/KG	0	0%		0	0	108	380 U	390 U	380 U	390 U	380 U	370 U
Bis(2-Chloroisopropyl)ether	UG/KG	0	0%		0	0	3						
Bis(2-Ethylhexyl)phthalate	UG/KG	990	19%	50000	0	34	178	47 J	86 J	380 U	26 J	380 U	370 U
Butylbenzylphthalate	UG/KG	0	0%	50000	0	0	178	380 U	390 U	380 U	390 U	380 U	370 U
Caprolactam	UG/KG	0	0%		0	0	99	380 U	390 U	380 U	390 U	380 U	370 U
Carbazole	UG/KG	755	19%		0	20	108	380 U	110 J	380 U	390 U	380 U	370 U
Chrysene	UG/KG	8900	51%	400	62	91	178	380 U	410	380 U	390 U	380 U	370 U
Di-n-butylphthalate	UG/KG	965	2%	8100	0	4	178	380 U	390 U	380 U	390 U	380 U	370 U
Di-n-octylphthalate	UG/KG	0	0%	50000	0	0	178	380 U	390 U	380 U	390 U	380 U	370 U
Dibenz(a,h)anthracene	UG/KG	1665	38%	14	67	68	178	380 U	58 J	380 U	390 U	380 U	370 U
Dibenzofuran	UG/KG	2350	16%	6200	0	28	178	380 U	64 J	380 U	390 U	380 U	370 U
Diethyl phthalate	UG/KG	10	1%	7100	0	1	178	380 U	390 U	380 U	390 U	380 U	370 U
Dimethylphthalate	UG/KG	0	0%	2000	0	0	178	380 U	390 U	380 U	390 U	380 U	370 U
Fluoranthene	UG/KG	23500	54%	50000	0	97	178	380 U	800	380 U	390 U	380 U	370 U
Fluorene	UG/KG	2640	28%	50000	0	49	178	380 U	72 J	380 U	390 U	380 U	370 U
Hexachlorobenzene	UG/KG	0	0%	410	0	0	178	380 U	390 U	380 U	390 U	380 U	370 U
Hexachlorobutadiene	UG/KG	0	0%		0	0	178	380 U	390 U	380 U	390 U	380 U	370 U
Hexachlorocyclopentadiene	UG/KG	0	0%		0	0	108	380 U	390 U	380 U	390 U	380 U	370 U
Hexachloroethane	UG/KG	0	0%		0	0	178	380 U	390 U	380 U	390 U	380 U	370 U
Indeno(1,2,3-cd)pyrene	UG/KG	4950	47%	3200	2	84	178	380 U	210 J	380 U	390 U	380 U	370 U
Isophorone	UG/KG	0	0%	4400	0	0	178	380 U	390 U	380 U	390 U	380 U	370 U
N-Nitrosodiphenylamine	UG/KG	100	1%		0	1	108	380 U	390 U	380 U	390 U	380 U	370 U
N-Nitrosodipropylamine	UG/KG	0	0%		0	0	108	380 U	390 U	380 U	390 U	380 U	370 U
Naphthalene	UG/KG	1800	19%	13000	0	34	178	380 U	77 J	380 U	390 U	380 U	370 U
Nitrobenzene	UG/KG	0	0%	200	0	0	178	380 U	390 U	380 U	390 U	380 U	370 U
Pentachlorophenol	UG/KG	0	0%	1000	0	0	178	970 U	990 U	960 U	980 U	960 U	920 U
Phenanthrene	UG/KG	21300	51%	50000	0	90	178	41 NJ	600	380 U	390 U	380 U	370 U
Phenol	UG/KG	0	0%	30	0	0	178	380 U	390 U	380 U	390 U	380 U	370 U
Pyrene	UG/KG	19200	55%	50000	0	98	178	380 U	660	380 U	390 U	25 J	370 U
Pyridine	UG/KG	0	0%		0	0	100	380 U	390 U	380 U			
Total Unknown PAHs as SV	MG/KG	25	100%		0	3	3						
Pesticides/PCBs													
4,4'-DDD	UG/KG	740	28%	2900	0	49	178	5.4	35 J	3.8 U	3.9 U	3.9 U	3.7 U
4,4'-DDE	UG/KG	2600	37%	2100	1	65	178	3.8 U	32 NJ	3.8 U	3.9 U	3.9 U	3.7 U
4,4'-DDT	UG/KG	3700	33%	2100	1	59	178	3.8 U	16	3.8 U	3.9 U	3.9 U	3.7 U
Aldrin	UG/KG	1.2	1%	41	0	1	178	2 U	2 U	2 U	2 U	2 U	1.9 U

**Table A-2A
SURFACE SOIL SAMPLE RESULTS (0-2 ft.)
SEAD-59
SEAD-59 and SEAD-71 Phase II RI Report
Seneca Army Depot Activity**

Facility	SEAD-59	SEAD-59	SEAD-59	SEAD-59	SEAD-59	SEAD-59							
Location ID	CL-59-01-WS4	CL-59-01-WS5	CL-59-01-WS6	CL-59-01-WW1	CL-59-01-WW2	CL-59-01-WW3							
Maxtrix	SOIL	SOIL	SOIL	SOIL	SOIL	SOIL							
Sample ID	CL-59-01-WS4	CL-59-01-WS5	CL-59-01-WS6	CL-59-01-WW1	CL-59-01-WW2	CL-59-01-WW3							
Sample Depth to Top of Sample ⁽¹⁾	0	0	0	0	0	0							
Sample Depth to Bottom of Sample ⁽¹⁾	0	0	0	0	0	0							
Sample Date	5/6/2004	5/6/2004	5/6/2004	5/6/2004	5/6/2004	5/6/2004							
QC Code	SA	SA	SA	SA	SA	SA							
Study ID	ENSR IRM	ENSR IRM	ENSR IRM	ENSR IRM	ENSR IRM	ENSR IRM							
Sample Round	1	1	1	1	1	1							
Parameter	Units	Maximum Value	Frequency of Detection	NYSDEC TAGM 4046 ⁽²⁾	Number of Exceedances	Number of Detects	Number of Analyses ⁽³⁾	Value (Q)	Value (Q)	Value (Q)	Value (Q)	Value (Q)	Value (Q)
Alpha-BHC	UG/KG	0	0%	110	0	0	178	2 U	2 U	2 U	2 U	2 U	1.9 U
Alpha-Chlordane	UG/KG	34	4%		0	7	178	2 U	2 U	2 U	2 U	2 U	1.9 U
Beta-BHC	UG/KG	2.4	1%	200	0	1	178	2 U	2.4 J	2 U	2 U	2 U	1.9 U
Delta-BHC	UG/KG	0	0%	300	0	0	178	2 U	2 U	2 U	2 U	2 U	1.9 U
Dieldrin	UG/KG	0	0%	44	0	0	178	3.8 U	3.9 U	3.8 U	3.9 U	3.9 U	3.7 U
Endosulfan I	UG/KG	16	1%	900	0	1	178	2 U	2 U	2 U	2 U	2 U	1.9 U
Endosulfan II	UG/KG	0	0%	900	0	0	178	3.8 U	3.9 U	3.8 U	3.9 U	3.9 U	3.7 U
Endosulfan sulfate	UG/KG	6.2	1%	1000	0	1	178	3.8 U	3.9 U	3.8 U	3.9 U	3.9 U	3.7 U
Endrin	UG/KG	16	2%	100	0	3	178	3.8 U	3.9 U	3.8 U	3.9 U	3.9 U	3.7 U
Endrin aldehyde	UG/KG	4.9	1%		0	2	178	3.8 U	3.9 U	3.8 U	3.9 U	3.9 U	3.7 U
Endrin ketone	UG/KG	38	2%		0	4	178	3.8 U	3.9 U	3.8 U	3.9 U	3.9 U	3.7 U
Gamma-BHC/Lindane	UG/KG	0	0%	60	0	0	178	2 U	2 U	2 U	2 U	2 U	1.9 U
Gamma-Chlordane	UG/KG	24	8%	540	0	14	178	2 UJ	2 UJ	2 UJ	2 U	2 U	1.9 U
Heptachlor	UG/KG	0	0%	100	0	0	178	2 U	2 U	2 U	2 U	2 U	1.9 U
Heptachlor epoxide	UG/KG	3	1%	20	0	2	178	2 U	2 U	2 U	2 U	2 U	1.9 U
Methoxychlor	UG/KG	0	0%		0	0	178	20 U	20 U	20 U	20 U	20 U	19 U
Toxaphene	UG/KG	0	0%		0	0	178	200 U	200 U	200 U	200 U	200 U	190 U
Aroclor-1016	UG/KG	0	0%		0	0	178	38 U	40 U	38 U	40 U	39 U	37 U
Aroclor-1221	UG/KG	0	0%		0	0	178	38 U	40 U	38 U	40 U	39 U	37 U
Aroclor-1232	UG/KG	0	0%		0	0	178	38 U	40 U	38 U	40 U	39 U	37 U
Aroclor-1242	UG/KG	0	0%		0	0	178	38 U	40 U	38 U	40 U	39 U	37 U
Aroclor-1248	UG/KG	0	0%		0	0	178	38 U	40 U	38 U	40 U	39 U	37 U
Aroclor-1254	UG/KG	0	0%	10000	0	0	178	38 U	40 U	38 U	40 U	39 U	37 U
Aroclor-1260	UG/KG	79	1%	10000	0	2	178	38 U	40 U	38 U	40 U	39 U	37 U
Metals													
Aluminum	MG/KG	18300	100%	19300	0	178	178	12700 J	7150 J	12600 J	16900 J	14000 J	10500 J
Antimony	MG/KG	424	58%	5.9	5	104	178	1.6 J	1.4 J	1.8 J	1.7 J	1.9 J	1.4 J
Arsenic	MG/KG	32.2	100%	8.2	7	178	178	4.8 J	2.8 J	10.3 J	5.8	5.5	6.5
Barium	MG/KG	304	100%	300	1	178	178	100 J	76.8 J	158 J	192 J	176 J	113 J
Beryllium	MG/KG	2.6	99%	1.1	2	176	178	0.66	0.42	0.73	0.91	0.66	0.54
Cadmium	MG/KG	3.2	86%	2.3	2	153	178	0.63	0.96	0.88	0.39	0.41	0.21 J
Calcium	MG/KG	214000	100%	121000	1	178	178	1620 J	58000 J	2100 J	7600	6170	3230
Chromium	MG/KG	39.3	100%	29.6	2	178	178	18.4 J	15.9 J	20.1 J	20.3 J	19.7 J	16.2 J
Cobalt	MG/KG	47.8	100%	30	2	178	178	10.2 J	6.4 J	17.7 J	7.6	10.4	8.1
Copper	MG/KG	305	100%	33	19	178	178	15.1 J	50.9 J	26 J	24.3 J	17.9 J	20.5 J
Cyanide	MG/KG	0	0%	0.35	0	0	9						
Iron	MG/KG	64000	100%	36500	1	178	178	20300 J	11400 J	27600 J	22900 J	25600 J	23600 J
Lead	MG/KG	164	100%	24.8	75	178	178	14.2 J	72.6 J	16.5 J	22.7 J	26.3 J	13.4 J
Magnesium	MG/KG	30200	100%	21500	3	178	178	3530 J	9980 J	4640 J	4270 J	4470 J	3790 J
Manganese	MG/KG	1290	100%	1060	3	178	178	512 J	272 J	1290 J	400 J	769 J	405 J
Mercury	MG/KG	0.95	95%	0.1	37	169	178	0.08	0.07	0.09	0.15	0.11	0.13
Nickel	MG/KG	88.3	100%	49	3	178	178	22.6 J	23.6 J	40.6 J	23.5 J	25.3 J	23.3 J
Potassium	MG/KG	2290	100%	2380	0	178	178	1000 J	1080 J	872 J	1360	1150	955
Selenium	MG/KG	1.5	9%	2	0	16	178	0.79 J	0.55 J	0.47 U	0.45 U	0.47 U	0.43 U
Silver	MG/KG	2.9	49%	0.75	62	87	178	0.72	0.1 U	0.83	1.9	2.1	1.9
Sodium	MG/KG	4060	99%	172	86	177	178	1480 J	956 J	2230 J	139	58.6	50.3

**Table A-2A
SURFACE SOIL SAMPLE RESULTS (0-2 ft.)
SEAD-59
SEAD-59 and SEAD-71 Phase II RI Report
Seneca Army Depot Activity**

				SEAD-59	SEAD-59	SEAD-59	SEAD-59	SEAD-59	SEAD-59	SEAD-59			
				CL-59-01-WS4	CL-59-01-WS5	CL-59-01-WS6	CL-59-01-WW1	CL-59-01-WW2	CL-59-01-WW3	CL-59-01-WW3			
				SOIL	SOIL	SOIL	SOIL	SOIL	SOIL	SOIL			
				CL-59-01-WS4	CL-59-01-WS5	CL-59-01-WS6	CL-59-01-WW1	CL-59-01-WW2	CL-59-01-WW3	CL-59-01-WW3			
Sample Depth to Top of Sample ⁽¹⁾				0	0	0	0	0	0	0			
Sample Depth to Bottom of Sample ⁽¹⁾				0	0	0	0	0	0	0			
Sample Date				5/6/2004	5/6/2004	5/6/2004	5/6/2004	5/6/2004	5/6/2004	5/6/2004			
QC Code				SA	SA	SA	SA	SA	SA	SA			
Study ID				ENSR IRM	ENSR IRM	ENSR IRM	ENSR IRM	ENSR IRM	ENSR IRM	ENSR IRM			
Sample Round				1	1	1	1	1	1	1			
Parameter	Units	Maximum Value	Frequency of Detection	NYSDEC TAGM 4046 ⁽²⁾	Number of Exceedances	Number of Detects	Number of Analyses ⁽³⁾	Value (Q)	Value (Q)	Value (Q)	Value (Q)	Value (Q)	Value (Q)
Thallium	MG/KG	1.8	29%	0.7	24	51	178	0.21 U	0.2 U	0.23 U	0.23 U	0.23 U	0.21 U
Vanadium	MG/KG	28.5	100%	150	0	178	178	21.8 J	17.8 J	24.6 J	25.1 J	22.2 J	20.3 J
Zinc	MG/KG	341	100%	110	19	178	178	60.7 J	99.5 J	74.1 J	75.2 J	95 J	68.6 J

Note(s):

(1) - Historical sample depths are presented (I.e. prior to 2002 TCRA)

(2) - NYSDEC Technical and Administrative Guidance Memorandum (TAGM) HWR-94-4046, Revised January 24, 1994

(3) - Sample/Duplicate pair are presented as individual samples in this table. Statistical information used Sample Duplicate pairs as a single entity and averaged result values were used in risk assessment analysis.

U = compound was not detected

J = the reported value is an estimated concentration

UJ = the compound was not detected; the associated reporting limit is approximate

R = the data was rejected in the data validating process

NJ = compound was "tentatively identified" and the associated numerical value is approximate

**Table A-2A
SURFACE SOIL SAMPLE RESULTS (0-2 ft.)
SEAD-59
SEAD-59 and SEAD-71 Phase II RI Report
Seneca Army Depot Activity**

Facility	SEAD-59	SEAD-59	SEAD-59	SEAD-59	SEAD-59	SEAD-59							
Location ID	CL-59-02-F01	CL-59-02-WE1	CL-59-02-WE2	CL-59-02-WN1	CL-59-02-WN2	CL-59-02-WS1							
Maxtrix	SOIL	SOIL	SOIL	SOIL	SOIL	SOIL							
Sample ID	CL-59-02-F01	CL-59-02-WE1	CL-59-02-WE2	CL-59-02-WN1	CL-59-02-WN2	CL-59-02-WS1							
Sample Depth to Top of Sample ⁽¹⁾	0	0	0	0	0	0							
Sample Depth to Bottom of Sample ⁽¹⁾	0	0	0	0	0	0							
Sample Date	5/6/2004	5/6/2004	5/6/2004	5/6/2004	5/6/2004	5/6/2004							
QC Code	SA	SA	SA	SA	SA	SA							
Study ID	ENSR IRM	ENSR IRM	ENSR IRM	ENSR IRM	ENSR IRM	ENSR IRM							
Sample Round	1	1	1	1	1	1							
Parameter	Units	Maximum Value	Frequency of Detection	NYSDEC TAGM 4046 ⁽²⁾	Number of Exceedances	Number of Detects	Number of Analyses ⁽³⁾	Value (Q)	Value (Q)	Value (Q)	Value (Q)	Value (Q)	Value (Q)
Volatile Organics													
1,1,1-Trichloroethane	UG/KG	0	0%	800	0	0	177	5 U	5 U	4 U	5 U	5 U	5 U
1,1,2,2-Tetrachloroethane	UG/KG	0	0%	600	0	0	169	5 UJ	5 UJ	4 U	5 U	5 U	5 U
1,1,2-Trichloro-1,2,2-Trifluoroethane	UG/KG	0	0%		0	0	168	5 U	5 U	4 U	5 U	5 U	5 U
1,1,2-Trichloroethane	UG/KG	0	0%		0	0	107	5 U	5 U	4 U	5 U	5 U	5 U
1,1-Dichloroethane	UG/KG	0	0%	200	0	0	177	5 U	5 U	4 U	5 U	5 U	5 U
1,1-Dichloroethene	UG/KG	8	2%	400	0	3	177	5 U	5 U	4 U	5 U	5 U	5 U
1,2,3-Trichloropropane	UG/KG	0	0%		0	0	70						
1,2,4-Trichlorobenzene	UG/KG	0	0%	3400	0	0	161	5 UJ	5 UJ	4 U	5 U	5 U	5 U
1,2-Dibromo-3-chloropropane	UG/KG	0	0%		0	0	91	5 UJ	5 UJ	4 U	5 U	5 U	5 U
1,2-Dibromoethane	UG/KG	0	0%		0	0	98	5 U	5 UJ	4 U	5 U	5 U	5 U
1,2-Dichlorobenzene	UG/KG	0	0%	7900	0	0	161	5 UJ	5 UJ	4 U	5 U	5 U	5 U
1,2-Dichloroethane	UG/KG	0	0%	100	0	0	177	5 U	5 U	4 U	5 U	5 U	5 U
1,2-Dichloroethene (total)	UG/KG	0	0%		0	0	9						
1,2-Dichloropropane	UG/KG	0	0%		0	0	107	5 U	5 U	4 U	5 U	5 U	5 U
1,3-Dichlorobenzene	UG/KG	0	0%	1600	0	0	161	5 UJ	5 UJ	4 U	5 U	5 U	5 U
1,3-Dichloropropane	UG/KG	0	0%		0	0	70						
1,4-Dichlorobenzene	UG/KG	0	0%	8500	0	0	161	5 UJ	5 UJ	4 U	5 U	5 U	5 U
Acetone	UG/KG	550	27%	200	2	47	177	5 U	5 UJ	4 U	5 U	5 U	5 U
Benzene	UG/KG	3	4%	60	0	7	177	5 U	5 U	4 U	5 U	5 U	5 U
Bromodichloromethane	UG/KG	0	0%		0	0	107	5 U	5 U	4 U	5 U	5 U	5 U
Bromoform	UG/KG	0	0%		0	0	107	5 U	5 UJ	4 U	5 U	5 U	5 U
Carbon disulfide	UG/KG	4	3%	2700	0	6	177	5 U	5 U	4 U	5 U	5 U	5 U
Carbon tetrachloride	UG/KG	0	0%	600	0	0	177	5 U	5 U	4 U	5 U	5 U	5 U
Chlorobenzene	UG/KG	0	0%	1700	0	0	177	5 U	5 UJ	4 U	5 U	5 U	5 U
Chlorodibromomethane	UG/KG	0	0%		0	0	177	5 U	5 UJ	4 U	5 U	5 U	5 U
Chloroethane	UG/KG	0	0%	1900	0	0	177	5 U	5 UJ	4 U	5 U	5 U	5 U
Chloroform	UG/KG	0	0%	300	0	0	177	5 U	5 U	4 U	5 U	5 U	5 U
Cis-1,2-Dichloroethene	UG/KG	0	0%		0	0	98	5 U	5 U	4 U	5 U	5 U	5 U
Cis-1,3-Dichloropropene	UG/KG	0	0%		0	0	107	5 U	5 U	4 U	5 U	5 U	5 U
Cyclohexane	UG/KG	3	8%		0	8	98	5 U	5 U	4 U	5 U	5 U	5 U
Dichlorodifluoromethane	UG/KG	0	0%		0	0	98	5 U	5 U	4 U	5 U	5 U	5 U
Ethyl benzene	UG/KG	4.6	1%	5500	0	2	177	5 U	5 UJ	4 U	5 U	5 U	5 U
Isopropylbenzene	UG/KG	0	0%		0	0	98	5 U	5 UJ	4 U	5 U	5 U	5 U
Meta/Para Xylene	UG/KG	9.4	4%		0	3	70						
Methyl Acetate	UG/KG	2	3%		0	3	98	5 U	5 U	4 U	5 U	5 U	5 U
Methyl Tertbutyl Ether	UG/KG	0	0%		0	0	98	5 U	5 U	4 U	5 U	5 U	5 U
Methyl bromide	UG/KG	0	0%		0	0	107	5 U	5 U	4 U	5 U	5 U	5 U
Methyl butyl ketone	UG/KG	0	0%		0	0	107	5 U	5 UJ	4 U	5 U	5 U	5 U
Methyl chloride	UG/KG	0	0%		0	0	107	5 U	5 U	4 U	5 U	5 U	5 U
Methyl cyclohexane	UG/KG	5	10%		0	10	98	5 U	5 U	4 U	5 U	5 U	5 U
Methyl ethyl ketone	UG/KG	190	12%	300	0	22	177	5 U	5 U	4 U	5 U	5 U	5 U
Methyl isobutyl ketone	UG/KG	1.9	1%	1000	0	1	177	5 U	5 U	4 U	5 U	5 U	5 U
Methylene chloride	UG/KG	4.9	20%	100	0	36	178	2 J	5 U	2 J	1 J	2 J	2 J
Ortho Xylene	UG/KG	5.05	4%		0	3	70						

Table A-2A
SURFACE SOIL SAMPLE RESULTS (0-2 ft.)
SEAD-59
SEAD-59 and SEAD-71 Phase II RI Report
Seneca Army Depot Activity

Facility	SEAD-59	SEAD-59	SEAD-59	SEAD-59	SEAD-59	SEAD-59							
Location ID	CL-59-02-F01	CL-59-02-WE1	CL-59-02-WE2	CL-59-02-WN1	CL-59-02-WN2	CL-59-02-WS1							
Maxtrix	SOIL	SOIL	SOIL	SOIL	SOIL	SOIL							
Sample ID	CL-59-02-F01	CL-59-02-WE1	CL-59-02-WE2	CL-59-02-WN1	CL-59-02-WN2	CL-59-02-WS1							
Sample Depth to Top of Sample ⁽¹⁾	0	0	0	0	0	0							
Sample Depth to Bottom of Sample ⁽¹⁾	0	0	0	0	0	0							
Sample Date	5/6/2004	5/6/2004	5/6/2004	5/6/2004	5/6/2004	5/6/2004							
QC Code	SA	SA	SA	SA	SA	SA							
Study ID	ENSR IRM	ENSR IRM	ENSR IRM	ENSR IRM	ENSR IRM	ENSR IRM							
Sample Round	1	1	1	1	1	1							
Parameter	Units	Maximum Value	Frequency of Detection	NYSDEC TAGM 4046 ⁽²⁾	Number of Exceedances	Number of Detects	Number of Analyses ⁽³⁾	Value (Q)	Value (Q)	Value (Q)	Value (Q)	Value (Q)	Value (Q)
Styrene	UG/KG	0	0%		0	0	107	5 U	5 UJ	4 U	5 U	5 U	5 U
Tetrachloroethene	UG/KG	6.4	3%	1400	0	5	177	5 U	5 UJ	4 U	5 U	5 U	5 U
Toluene	UG/KG	8	8%	1500	0	14	177	5 U	5 U	4 U	5 U	5 U	5 U
Total BTEX	MG/KG	3.25	67%		0	2	3						
Total Xylenes	UG/KG	3	7%	1200	0	7	102	5 UJ	5 UJ	4 U	5 U	5 U	5 U
Trans-1,2-Dichloroethene	UG/KG	0	0%	300	0	0	168	5 U	5 U	4 U	5 U	5 U	5 U
Trans-1,3-Dichloropropene	UG/KG	0	0%		0	0	107	5 U	5 U	4 U	5 U	5 U	5 U
Trichloroethene	UG/KG	4.5	5%	700	0	8	177	5 U	5 U	4 U	5 U	5 U	5 U
Trichlorofluoromethane	UG/KG	6	1%		0	1	98	5 U	5 U	4 U	5 U	5 U	5 U
Vinyl chloride	UG/KG	0	0%	200	0	0	177	5 U	5 U	4 U	5 U	5 U	5 U
Semivolatile Organics													
1,1'-Biphenyl	UG/KG	254.5	2%		0	2	99	370 U	380 U	360 U	400 U	350 U	360 U
1,2,4-Trichlorobenzene	UG/KG	0	0%	3400	0	0	9						
1,2-Dichlorobenzene	UG/KG	0	0%	7900	0	0	9						
1,3-Dichlorobenzene	UG/KG	0	0%	1600	0	0	9						
1,4-Dichlorobenzene	UG/KG	0	0%	8500	0	0	9						
2,2'-oxybis(1-Chloropropane)	UG/KG	0	0%		0	0	105	370 U	380 U	360 U	400 U	350 U	360 U
2,4,5-Trichlorophenol	UG/KG	0	0%	100	0	0	178	930 U	960 U	890 U	1000 U	870 U	900 U
2,4,6-Trichlorophenol	UG/KG	0	0%		0	0	178	370 U	380 U	360 U	400 U	350 U	360 U
2,4-Dichlorophenol	UG/KG	0	0%	400	0	0	178	370 U	380 U	360 U	400 U	350 U	360 U
2,4-Dimethylphenol	UG/KG	0	0%		0	0	108	370 U	380 U	360 U	400 U	350 U	360 U
2,4-Dinitrophenol	UG/KG	0	0%	200	0	0	178	930 UJ	960 UJ	890 UJ	1000 UJ	870 U	900 U
2,4-Dinitrotoluene	UG/KG	0	0%		0	0	178	370 U	380 U	360 U	400 U	350 U	360 U
2,6-Dinitrotoluene	UG/KG	0	0%	1000	0	0	178	370 U	380 U	360 U	400 U	350 U	360 U
2-Chloronaphthalene	UG/KG	0	0%		0	0	108	370 U	380 U	360 U	400 U	350 U	360 U
2-Chlorophenol	UG/KG	0	0%	800	0	0	178	370 U	380 U	360 U	400 U	350 U	360 U
2-Methylnaphthalene	UG/KG	1295	19%	36400	0	34	178	370 U	380 U	360 U	400 U	350 U	360 U
2-Methylphenol	UG/KG	0	0%	100	0	0	178	370 U	380 U	360 U	400 U	350 U	360 U
2-Nitroaniline	UG/KG	0	0%	430	0	0	178	930 U	960 U	890 U	1000 U	870 U	900 U
2-Nitrophenol	UG/KG	0	0%	330	0	0	178	370 U	380 U	360 U	400 U	350 U	360 U
3,3'-Dichlorobenzidine	UG/KG	0	0%		0	0	178	370 U	380 U	360 U	400 U	350 U	360 U
3-Nitroaniline	UG/KG	0	0%	500	0	0	178	930 U	960 U	890 U	1000 U	870 U	900 U
4,6-Dinitro-2-methylphenol	UG/KG	0	0%		0	0	108	930 U	960 U	890 U	1000 U	870 U	900 U
4-Bromophenyl phenyl ether	UG/KG	0	0%		0	0	108	370 U	380 U	360 U	400 U	350 U	360 U
4-Chloro-3-methylphenol	UG/KG	0	0%	240	0	0	178	370 U	380 U	360 U	400 U	350 U	360 U
4-Chloroaniline	UG/KG	1200	1%	220	1	2	178	370 UJ	380 UJ	360 UJ	400 UJ	350 UJ	360 UJ
4-Chlorophenyl phenyl ether	UG/KG	0	0%		0	0	108	370 U	380 U	360 U	400 U	350 U	360 U
4-Methylphenol	UG/KG	150	3%	900	0	5	178	370 U	380 U	360 U	400 U	350 U	360 U
4-Nitroaniline	UG/KG	0	0%		0	0	108	930 UJ	960 UJ	890 UJ	1000 UJ	870 U	900 U
4-Nitrophenol	UG/KG	0	0%	100	0	0	178	930 U	960 U	890 U	1000 U	870 U	900 U
Acenaphthene	UG/KG	2680	24%	50000	0	42	178	370 U	380 U	360 U	400 U	350 U	360 U
Acenaphthylene	UG/KG	1700	37%	41000	0	66	178	370 U	380 U	360 U	400 U	350 U	360 U
Acetophenone	UG/KG	0	0%		0	0	99	370 U	380 U	360 U	400 U	350 U	360 U
Aniline	UG/KG	0	0%		0	0	70						
Anthracene	UG/KG	4395	43%	50000	0	77	178	370 U	380 U	360 U	400 U	350 U	360 U

Table A-2A
SURFACE SOIL SAMPLE RESULTS (0-2 ft.)
SEAD-59
SEAD-59 and SEAD-71 Phase II RI Report
Seneca Army Depot Activity

Facility	SEAD-59	SEAD-59	SEAD-59	SEAD-59	SEAD-59	SEAD-59							
Location ID	CL-59-02-F01	CL-59-02-WE1	CL-59-02-WE2	CL-59-02-WN1	CL-59-02-WN2	CL-59-02-WS1							
Maxtrix	SOIL	SOIL	SOIL	SOIL	SOIL	SOIL							
Sample ID	CL-59-02-F01	CL-59-02-WE1	CL-59-02-WE2	CL-59-02-WN1	CL-59-02-WN2	CL-59-02-WS1							
Sample Depth to Top of Sample ⁽¹⁾	0	0	0	0	0	0							
Sample Depth to Bottom of Sample ⁽¹⁾	0	0	0	0	0	0							
Sample Date	5/6/2004	5/6/2004	5/6/2004	5/6/2004	5/6/2004	5/6/2004							
QC Code	SA	SA	SA	SA	SA	SA							
Study ID	ENSR IRM	ENSR IRM	ENSR IRM	ENSR IRM	ENSR IRM	ENSR IRM							
Sample Round	1	1	1	1	1	1							
Parameter	Units	Maximum Value	Frequency of Detection	NYSDEC TAGM 4046 ⁽²⁾	Number of Exceedances	Number of Detects	Number of Analyses ⁽³⁾	Value (Q)	Value (Q)	Value (Q)	Value (Q)	Value (Q)	Value (Q)
Atrazine	UG/KG	120	1%		0	1	99	370 U	380 U	360 U	400 U	350 U	360 U
Benzaldehyde	UG/KG	50	1%		0	1	99	370 UJ	380 UJ	360 UJ	400 UJ	350 UJ	360 UJ
Benzo(a)anthracene	UG/KG	8900	51%	224	72	90	178	370 U	380 U	360 U	400 U	350 U	360 U
Benzo(a)pyrene	UG/KG	8050	51%	61	84	91	178	370 U	380 U	360 U	400 U	350 U	360 U
Benzo(b)fluoranthene	UG/KG	6800	52%	1100	40	92	178	370 U	380 U	360 U	400 U	350 U	360 U
Benzo(ghi)perylene	UG/KG	5200	46%	50000	0	82	178	370 U	380 U	360 U	400 U	350 U	360 U
Benzo(k)fluoranthene	UG/KG	7350	49%	1100	35	88	178	370 U	380 U	360 U	400 U	350 U	360 U
Benzoic Acid	UG/KG	0	0%	2700	0	0	70						
Bis(2-Chloroethoxy)methane	UG/KG	0	0%		0	0	108	370 U	380 U	360 U	400 U	350 U	360 U
Bis(2-Chloroethyl)ether	UG/KG	0	0%		0	0	108	370 U	380 U	360 U	400 U	350 U	360 U
Bis(2-Chloroisopropyl)ether	UG/KG	0	0%		0	0	3						
Bis(2-Ethylhexyl)phthalate	UG/KG	990	19%	50000	0	34	178	370 U	380 U	360 U	400 U	350 U	360 U
Butylbenzylphthalate	UG/KG	0	0%	50000	0	0	178	370 U	380 U	360 U	400 U	350 U	360 U
Caprolactam	UG/KG	0	0%		0	0	99	370 U	380 U	360 U	400 U	350 U	360 U
Carbazole	UG/KG	755	19%		0	20	108	370 U	380 U	360 U	400 U	350 U	360 U
Chrysene	UG/KG	8900	51%	400	62	91	178	370 U	380 U	360 U	400 U	350 U	360 U
Di-n-butylphthalate	UG/KG	965	2%	8100	0	4	178	370 U	380 U	360 U	400 U	350 U	360 U
Di-n-octylphthalate	UG/KG	0	0%	50000	0	0	178	370 U	380 U	360 U	400 U	350 U	360 U
Dibenz(a,h)anthracene	UG/KG	1665	38%	14	67	68	178	370 U	380 U	360 U	400 U	350 U	360 U
Dibenzofuran	UG/KG	2350	16%	6200	0	28	178	370 U	380 U	360 U	400 U	350 U	360 U
Diethyl phthalate	UG/KG	10	1%	7100	0	1	178	370 U	380 U	360 U	400 U	350 U	360 U
Dimethylphthalate	UG/KG	0	0%	2000	0	0	178	370 U	380 U	360 U	400 U	350 U	360 U
Fluoranthene	UG/KG	23500	54%	50000	0	97	178	370 U	380 U	360 U	400 U	350 U	360 U
Fluorene	UG/KG	2640	28%	50000	0	49	178	370 U	380 U	360 U	400 U	350 U	360 U
Hexachlorobenzene	UG/KG	0	0%	410	0	0	178	370 U	380 U	360 U	400 U	350 U	360 U
Hexachlorobutadiene	UG/KG	0	0%		0	0	178	370 U	380 U	360 U	400 U	350 U	360 U
Hexachlorocyclopentadiene	UG/KG	0	0%		0	0	108	370 U	380 U	360 U	400 U	350 U	360 U
Hexachloroethane	UG/KG	0	0%		0	0	178	370 U	380 U	360 U	400 U	350 U	360 U
Indeno(1,2,3-cd)pyrene	UG/KG	4950	47%	3200	2	84	178	370 U	380 U	360 U	400 U	350 U	360 U
Isophorone	UG/KG	0	0%	4400	0	0	178	370 U	380 U	360 U	400 U	350 U	360 U
N-Nitrosodiphenylamine	UG/KG	100	1%		0	1	108	370 U	380 U	360 U	400 U	350 U	360 U
N-Nitrosodipropylamine	UG/KG	0	0%		0	0	108	370 U	380 U	360 U	400 U	350 U	360 U
Naphthalene	UG/KG	1800	19%	13000	0	34	178	370 U	380 U	360 U	400 U	350 U	360 U
Nitrobenzene	UG/KG	0	0%	200	0	0	178	370 U	380 U	360 U	400 U	350 U	360 U
Pentachlorophenol	UG/KG	0	0%	1000	0	0	178	930 U	960 U	890 U	1000 U	870 U	900 U
Phenanthrene	UG/KG	21300	51%	50000	0	90	178	370 U	380 U	360 U	400 U	350 U	360 U
Phenol	UG/KG	0	0%	30	0	0	178	370 U	380 U	360 U	400 U	350 U	360 U
Pyrene	UG/KG	19200	55%	50000	0	98	178	370 U	380 U	360 U	400 U	350 U	360 U
Pyridine	UG/KG	0	0%		0	0	100						
Total Unknown PAHs as SV	MG/KG	25	100%		0	3	3						
Pesticides/PCBs													
4,4'-DDD	UG/KG	740	28%	2900	0	49	178	3.8 U	3.8 U	3.5 U	4 U	3.4 U	3.6 U
4,4'-DDE	UG/KG	2600	37%	2100	1	65	178	3.8 U	3.8 U	3.5 U	4 U	3.4 U	3.6 U
4,4'-DDT	UG/KG	3700	33%	2100	1	59	178	4.3	3.8 U	3.5 U	4 U	3.4 U	3.6 U
Aldrin	UG/KG	1.2	1%	41	0	1	178	1.9 U	2 U	1.8 U	2 U	1.8 U	1.8 U

**Table A-2A
SURFACE SOIL SAMPLE RESULTS (0-2 ft.)
SEAD-59
SEAD-59 and SEAD-71 Phase II RI Report
Seneca Army Depot Activity**

Facility	SEAD-59						SEAD-59	SEAD-59	SEAD-59	SEAD-59	SEAD-59	SEAD-59	
Location ID	CL-59-02-F01						CL-59-02-WE1	CL-59-02-WE2	CL-59-02-WN1	CL-59-02-WN2	CL-59-02-WS1	CL-59-02-WS1	
Maxtrix	SOIL						SOIL	SOIL	SOIL	SOIL	SOIL	SOIL	
Sample ID	CL-59-02-F01						CL-59-02-WE1	CL-59-02-WE2	CL-59-02-WN1	CL-59-02-WN2	CL-59-02-WS1	CL-59-02-WS1	
Sample Depth to Top of Sample ⁽¹⁾	0						0	0	0	0	0	0	
Sample Depth to Bottom of Sample ⁽¹⁾	0						0	0	0	0	0	0	
Sample Date	5/6/2004						5/6/2004	5/6/2004	5/6/2004	5/6/2004	5/6/2004	5/6/2004	
QC Code	SA						SA	SA	SA	SA	SA	SA	
Study ID	ENSR IRM						ENSR IRM	ENSR IRM	ENSR IRM	ENSR IRM	ENSR IRM	ENSR IRM	
Sample Round	1						1	1	1	1	1	1	
Parameter	Units	Maximum Value	Frequency of Detection	NYSDEC TAGM 4046 ⁽²⁾	Number of Exceedances	Number of Detects	Number of Analyses ⁽³⁾	Value (Q)	Value (Q)	Value (Q)	Value (Q)	Value (Q)	Value (Q)
Alpha-BHC	UG/KG	0	0%	110	0	0	178	1.9 U	2 U	1.8 U	2 U	1.8 U	1.8 U
Alpha-Chlordane	UG/KG	34	4%		0	7	178	1.9 U	2 U	1.8 U	2 U	1.8 U	1.8 U
Beta-BHC	UG/KG	2.4	1%	200	0	1	178	1.9 U	2 U	1.8 U	2 U	1.8 U	1.8 U
Delta-BHC	UG/KG	0	0%	300	0	0	178	1.9 U	2 U	1.8 U	2 U	1.8 U	1.8 U
Dieldrin	UG/KG	0	0%	44	0	0	178	3.8 U	3.8 U	3.5 U	4 U	3.4 U	3.6 U
Endosulfan I	UG/KG	16	1%	900	0	1	178	1.9 U	2 U	1.8 U	2 U	1.8 U	1.8 U
Endosulfan II	UG/KG	0	0%	900	0	0	178	3.8 U	3.8 U	3.5 U	4 U	3.4 U	3.6 U
Endosulfan sulfate	UG/KG	6.2	1%	1000	0	1	178	3.8 U	3.8 U	3.5 U	4 U	3.4 U	3.6 U
Endrin	UG/KG	16	2%	100	0	3	178	3.8 U	3.8 U	3.5 U	4 U	3.4 U	3.6 U
Endrin aldehyde	UG/KG	4.9	1%		0	2	178	3.8 U	3.8 U	3.5 U	4 U	3.4 U	3.6 U
Endrin ketone	UG/KG	38	2%		0	4	178	3.8 U	3.8 U	3.5 U	4 U	3.4 U	3.6 U
Gamma-BHC/Lindane	UG/KG	0	0%	60	0	0	178	1.9 U	2 U	1.8 U	2 U	1.8 U	1.8 U
Gamma-Chlordane	UG/KG	24	8%	540	0	14	178	1.9 U	2.2 U	1.8 U	2 U	1.8 U	1.8 U
Heptachlor	UG/KG	0	0%	100	0	0	178	1.9 U	2 U	1.8 U	2 U	1.8 U	1.8 U
Heptachlor epoxide	UG/KG	3	1%	20	0	2	178	1.9 U	2 U	1.8 U	2 U	1.8 U	1.8 U
Methoxychlor	UG/KG	0	0%		0	0	178	19 U	20 U	18 U	20 U	18 U	18 U
Toxaphene	UG/KG	0	0%		0	0	178	190 UJ	200 U	180 U	200 U	180 U	180 U
Aroclor-1016	UG/KG	0	0%		0	0	178	38 U	38 U	35 U	40 U	35 U	36 U
Aroclor-1221	UG/KG	0	0%		0	0	178	38 U	38 U	35 U	40 U	35 U	36 U
Aroclor-1232	UG/KG	0	0%		0	0	178	38 U	38 U	35 U	40 U	35 U	36 U
Aroclor-1242	UG/KG	0	0%		0	0	178	38 U	38 U	35 U	40 U	35 U	36 U
Aroclor-1248	UG/KG	0	0%		0	0	178	38 U	38 U	35 U	40 U	35 U	36 U
Aroclor-1254	UG/KG	0	0%	10000	0	0	178	38 U	38 U	35 U	40 U	35 U	36 U
Aroclor-1260	UG/KG	79	1%	10000	0	2	178	38 U	38 U	35 U	40 U	35 U	36 U
Metals													
Aluminum	MG/KG	18300	100%	19300	0	178	178	9230 J	8050 J	7810 J	12000 J	7040 J	7480 J
Antimony	MG/KG	424	58%	5.9	5	104	178	1.5 J	1.2 J	1.3 J	2 J	0.99 J	0.83 J
Arsenic	MG/KG	32.2	100%	8.2	7	178	178	6.4 J	4.5 J	3.6 J	5.4 J	4.7 J	5.5 J
Barium	MG/KG	304	100%	300	1	178	178	57.6 J	56.7 J	55.6 J	149 J	42.3 J	36.8 J
Beryllium	MG/KG	2.6	99%	1.1	2	176	178	0.5	0.44	0.36	0.72	0.37	0.39
Cadmium	MG/KG	3.2	86%	2.3	2	153	178	0.22 J	0.13 J	0.24 J	0.39	0.21 J	0.17 J
Calcium	MG/KG	21400	100%	121000	1	178	178	5020 J	1980 J	77800 J	9570 J	37700 J	1880 J
Chromium	MG/KG	39.3	100%	29.6	2	178	178	15.9 J	14 J	12.2 J	16.5 J	12.1 J	13.3 J
Cobalt	MG/KG	47.8	100%	30	2	178	178	9 J	5.4 J	5.8 J	6.4 J	6.3 J	7.4 J
Copper	MG/KG	305	100%	33	19	178	178	24.5 J	21.6 J	15.4 J	29.4 J	31.4 J	23.7 J
Cyanide	MG/KG	0	0%	0.35	0	0	9						
Iron	MG/KG	64000	100%	36500	1	178	178	21900 J	16900 J	17100 J	20200 J	16900 J	19000 J
Lead	MG/KG	164	100%	24.8	75	178	178	12 J	9.3 J	7.1 J	54.8 J	8.8 J	9.8 J
Magnesium	MG/KG	30200	100%	21500	3	178	178	5020 J	3220 J	13600 J	3610 J	11800 J	3420 J
Manganese	MG/KG	1290	100%	1060	3	178	178	339 J	156 J	390 J	285 J	316 J	200 J
Mercury	MG/KG	0.95	95%	0.1	37	169	178	0.03 J	0.07 J	0.39 J	0.51 J	0.03 J	0.04 J
Nickel	MG/KG	88.3	100%	49	3	178	178	29.2 J	22.1 J	19.1 J	20.4 J	20.8 J	24.8 J
Potassium	MG/KG	2290	100%	2380	0	178	178	1000 J	978 J	942 J	978 J	725 J	653 J
Selenium	MG/KG	1.5	9%	2	0	16	178	0.46 U	0.41 U	0.42 U	0.49 U	0.42 U	0.41 U
Silver	MG/KG	2.9	49%	0.75	62	87	178	2.2 J	1.6 J	0.46 J	1.9 J	1.1 J	1.9 J
Sodium	MG/KG	4060	99%	172	86	177	178	97.5 J	402 J	156 J	48.3 J	93.8 J	66.6 J

**Table A-2A
SURFACE SOIL SAMPLE RESULTS (0-2 ft.)
SEAD-59
SEAD-59 and SEAD-71 Phase II RI Report
Seneca Army Depot Activity**

				SEAD-59	SEAD-59	SEAD-59	SEAD-59	SEAD-59	SEAD-59	SEAD-59	SEAD-59		
				CL-59-02-F01	CL-59-02-WE1	CL-59-02-WE2	CL-59-02-WN1	CL-59-02-WN2	CL-59-02-WN2	CL-59-02-WS1	CL-59-02-WS1		
				SOIL	SOIL	SOIL	SOIL	SOIL	SOIL	SOIL	SOIL		
				CL-59-02-F01	CL-59-02-WE1	CL-59-02-WE2	CL-59-02-WN1	CL-59-02-WN2	CL-59-02-WN2	CL-59-02-WS1	CL-59-02-WS1		
Facility													
Location ID													
Maxtrix													
Sample ID													
Sample Depth to Top of Sample ⁽¹⁾				0	0	0	0	0	0	0	0		
Sample Depth to Bottom of Sample ⁽¹⁾				0	0	0	0	0	0	0	0		
Sample Date				5/6/2004	5/6/2004	5/6/2004	5/6/2004	5/6/2004	5/6/2004	5/6/2004	5/6/2004		
QC Code				SA	SA	SA	SA	SA	SA	SA	SA		
Study ID				ENSR IRM	ENSR IRM	ENSR IRM	ENSR IRM	ENSR IRM	ENSR IRM	ENSR IRM	ENSR IRM		
Sample Round				1	1	1	1	1	1	1	1		
Parameter	Units	Maximum Value	Frequency of Detection	NYSDEC TAGM 4046 ⁽²⁾	Number of Exceedances	Number of Detects	Number of Analyses ⁽³⁾	Value (Q)	Value (Q)	Value (Q)	Value (Q)	Value (Q)	Value (Q)
Thallium	MG/KG	1.8	29%	0.7	24	51	178	0.23 U	0.36 J	0.21 U	0.24 U	0.43 J	0.21 U
Vanadium	MG/KG	28.5	100%	150	0	178	178	16.4 J	13.4 J	12.8 J	19.3 J	12.4 J	13.7 J
Zinc	MG/KG	341	100%	110	19	178	178	90.1 J	63.8 J	36.9 J	77.3 J	58.4 J	76.2 J

Note(s):

(1) - Historical sample depths are presented (I.e. prior to 2002 TCRA)

(2) - NYSDEC Technical and Administrative Guidance Memorandum (TAGM) HWR-94-4046, Revised January 24, 1994

(3) - Sample/Duplicate pair are presented as individual samples in this table. Statistical information used Sample Duplicate pairs as a single entity and averaged result values were used in risk assessment analysis.

U = compound was not detected

J = the reported value is an estimated concentration

UJ = the compound was not detected; the associated reporting limit is approximate

R = the data was rejected in the data validating process

NJ = compound was "tentatively identified" and the associated numerical value is approximate

Table A-2A
SURFACE SOIL SAMPLE RESULTS (0-2 ft.)
SEAD-59
SEAD-59 and SEAD-71 Phase II RI Report
Seneca Army Depot Activity

Facility	SEAD-59	SEAD-59	SEAD-59	SEAD-59	SEAD-59	SEAD-59							
Location ID	CL-59-02-WS2	CL-59-02-WW1	CL-59-02-WW2	CL-59-03-F01	CL-59-03-F02	CL-59-03-F03							
Maxtrix	SOIL	SOIL	SOIL	SOIL	SOIL	SOIL							
Sample ID	CL-59-02-WS2	CL-59-02-WW1	CL-59-02-WW2	CL-59-03-F01	CL-59-03-F02	CL-59-03-F03							
Sample Depth to Top of Sample ⁽¹⁾	0	0	0	0	0	0							
Sample Depth to Bottom of Sample ⁽¹⁾	0	0	0	0	0	0							
Sample Date	5/6/2004	5/6/2004	5/6/2004	5/6/2004	5/6/2004	5/6/2004							
QC Code	SA	SA	SA	SA	SA	SA							
Study ID	ENSR IRM	ENSR IRM	ENSR IRM	ENSR IRM	ENSR IRM	ENSR IRM							
Sample Round	1	1	1	1	1	1							
Parameter	Units	Maximum Value	Frequency of Detection	NYSDEC TAGM 4046 ⁽²⁾	Number of Exceedances	Number of Detects	Number of Analyses ⁽³⁾	Value (Q)	Value (Q)	Value (Q)	Value (Q)	Value (Q)	Value (Q)
Volatile Organics													
1,1,1-Trichloroethane	UG/KG	0	0%	800	0	0	177	5 U	5 U	5 U	6 U	6.3 U	5.7 U
1,1,2,2-Tetrachloroethane	UG/KG	0	0%	600	0	0	169	5 U	5 U	5 U	6 U	6.3 U	5.7 U
1,1,2-Trichloro-1,2,2-Trifluoroethane	UG/KG	0	0%		0	0	168	5 U	5 U	5 U	6 U	6.3 U	5.7 U
1,1,2-Trichloroethane	UG/KG	0	0%		0	0	107	5 U	5 U	5 U			
1,1-Dichloroethane	UG/KG	0	0%	200	0	0	177	5 U	5 U	5 U	6 U	6.3 U	5.7 U
1,1-Dichloroethene	UG/KG	8	2%	400	0	3	177	5 U	5 U	5 U	6 U	6.3 U	5.7 U
1,2,3-Trichloropropane	UG/KG	0	0%		0	0	70				6 U	6.3 U	5.7 U
1,2,4-Trichlorobenzene	UG/KG	0	0%	3400	0	0	161	5 U	5 U	5 U	6 U	6.3 U	5.7 U
1,2-Dibromo-3-chloropropane	UG/KG	0	0%		0	0	91	5 U	5 UJ	5 U			
1,2-Dibromoethane	UG/KG	0	0%		0	0	98	5 U	5 U	5 U			
1,2-Dichlorobenzene	UG/KG	0	0%	7900	0	0	161	5 U	5 U	5 U	6 U	6.3 U	5.7 U
1,2-Dichloroethane	UG/KG	0	0%	100	0	0	177	5 U	5 U	5 U	6 U	6.3 U	5.7 U
1,2-Dichloroethene (total)	UG/KG	0	0%		0	0	9						
1,2-Dichloropropane	UG/KG	0	0%		0	0	107	5 U	5 U	5 U			
1,3-Dichlorobenzene	UG/KG	0	0%	1600	0	0	161	5 U	5 U	5 U	6 U	6.3 U	5.7 U
1,3-Dichloropropane	UG/KG	0	0%		0	0	70				6 U	6.3 U	5.7 U
1,4-Dichlorobenzene	UG/KG	0	0%	8500	0	0	161	5 U	5 U	5 U	6 U	6.3 U	5.7 U
Acetone	UG/KG	550	27%	200	2	47	177	5 U	13 U	5 UJ	24 U	25 U	23 U
Benzene	UG/KG	3	4%	60	0	7	177	5 U	1 J	5 U	6 U	6.3 U	5.7 U
Bromodichloromethane	UG/KG	0	0%		0	0	107	5 U	5 U	5 U			
Bromoform	UG/KG	0	0%		0	0	107	5 U	5 UJ	5 U			
Carbon disulfide	UG/KG	4	3%	2700	0	6	177	5 U	5 U	5 U	6 U	6.3 U	5.7 U
Carbon tetrachloride	UG/KG	0	0%	600	0	0	177	5 U	5 U	5 U	6 U	6.3 U	5.7 U
Chlorobenzene	UG/KG	0	0%	1700	0	0	177	5 U	5 U	5 U	6 U	6.3 U	5.7 U
Chlorodibromomethane	UG/KG	0	0%		0	0	177	5 U	5 U	5 U	6 U	6.3 U	5.7 U
Chloroethane	UG/KG	0	0%	1900	0	0	177	5 U	5 U	5 UJ	12 U	13 U	11 U
Chloroform	UG/KG	0	0%	300	0	0	177	5 U	5 U	5 U	6 U	6.3 U	5.7 U
Cis-1,2-Dichloroethene	UG/KG	0	0%		0	0	98	5 U	5 U	5 U			
Cis-1,3-Dichloropropene	UG/KG	0	0%		0	0	107	5 U	5 U	5 U			
Cyclohexane	UG/KG	3	8%		0	8	98	5 U	3 J	5 U			
Dichlorodifluoromethane	UG/KG	0	0%		0	0	98	5 U	5 U	5 U			
Ethyl benzene	UG/KG	4.6	1%	5500	0	2	177	5 U	5 U	5 U	6 U	6.3 U	5.7 U
Isopropylbenzene	UG/KG	0	0%		0	0	98	5 U	5 U	5 U			
Meta/Para Xylene	UG/KG	9.4	4%		0	3	70				6 U	6.3 U	5.7 U
Methyl Acetate	UG/KG	2	3%		0	3	98	5 U	5 U	5 U			
Methyl Tertbutyl Ether	UG/KG	0	0%		0	0	98	5 U	5 U	5 U			
Methyl bromide	UG/KG	0	0%		0	0	107	5 U	5 U	5 U			
Methyl butyl ketone	UG/KG	0	0%		0	0	107	5 U	5 U	5 U			
Methyl chloride	UG/KG	0	0%		0	0	107	5 U	5 U	5 U			
Methyl cyclohexane	UG/KG	5	10%		0	10	98	5 U	5 J	5 U			
Methyl ethyl ketone	UG/KG	190	12%	300	0	22	177	5 U	2 J	5 U	12 U	13 U	11 U
Methyl isobutyl ketone	UG/KG	1.9	1%	1000	0	1	177	5 U	5 U	5 U	12 U	13 U	11 U
Methylene chloride	UG/KG	4.9	20%	100	0	36	178	1 J	5 U	5 U	6 U	6.3 U	1.3 J
Ortho Xylene	UG/KG	5.05	4%		0	3	70				6 U	6.3 U	5.7 U

Table A-2A
SURFACE SOIL SAMPLE RESULTS (0-2 ft.)
SEAD-59
SEAD-59 and SEAD-71 Phase II RI Report
Seneca Army Depot Activity

Facility	SEAD-59						SEAD-59	SEAD-59	SEAD-59	SEAD-59	SEAD-59		
Location ID	CL-59-02-WS2						CL-59-02-WW1	CL-59-02-WW2	CL-59-03-F01	CL-59-03-F02	CL-59-03-F03		
Maxtrix	SOIL						SOIL	SOIL	SOIL	SOIL	SOIL		
Sample ID	CL-59-02-WS2						CL-59-02-WW1	CL-59-02-WW2	CL-59-03-F01	CL-59-03-F02	CL-59-03-F03		
Sample Depth to Top of Sample ⁽¹⁾	0						0	0	0	0	0		
Sample Depth to Bottom of Sample ⁽¹⁾	0						0	0	0	0	0		
Sample Date	5/6/2004		5/6/2004		5/6/2004		5/6/2004		5/6/2004		5/6/2004		
QC Code	SA		SA		SA		SA		SA		SA		
Study ID	ENSR IRM		ENSR IRM		ENSR IRM		ENSR IRM		ENSR IRM		ENSR IRM		
Sample Round	1		1		1		1		1		1		
Parameter	Units	Maximum Value	Frequency of Detection	NYSDEC TAGM 4046 ⁽²⁾	Number of Exceedances	Number of Detects	Number of Analyses ⁽³⁾	Value (Q)	Value (Q)	Value (Q)	Value (Q)	Value (Q)	Value (Q)
Styrene	UG/KG	0	0%		0	0	107	5 U	5 U	5 U			
Tetrachloroethene	UG/KG	6.4	3%	1400	0	5	177	5 U	5 U	5 U	6 U	6.3 U	5.7 U
Toluene	UG/KG	8	8%	1500	0	14	177	5 U	3 J	5 U	6 U	6.3 U	5.7 U
Total BTEX	MG/KG	3.25	67%		0	2	3						
Total Xylenes	UG/KG	3	7%	1200	0	7	102	5 U	3 J	5 U			
Trans-1,2-Dichloroethene	UG/KG	0	0%	300	0	0	168	5 U	5 U	5 U	6 U	6.3 U	5.7 U
Trans-1,3-Dichloropropene	UG/KG	0	0%		0	0	107	5 U	5 U	5 U			
Trichloroethene	UG/KG	4.5	5%	700	0	8	177	5 U	5 U	5 U	6 U	6.3 U	5.7 U
Trichlorofluoromethane	UG/KG	6	1%		0	1	98	5 U	5 U	5 U			
Vinyl chloride	UG/KG	0	0%	200	0	0	177	5 U	5 U	5 U	12 U	13 U	11 U
Semivolatile Organics													
1,1'-Biphenyl	UG/KG	254.5	2%		0	2	99	370 U	360 U	390 U			
1,2,4-Trichlorobenzene	UG/KG	0	0%	3400	0	0	9						
1,2-Dichlorobenzene	UG/KG	0	0%	7900	0	0	9						
1,3-Dichlorobenzene	UG/KG	0	0%	1600	0	0	9						
1,4-Dichlorobenzene	UG/KG	0	0%	8500	0	0	9						
2,2'-oxybis(1-Chloropropane)	UG/KG	0	0%		0	0	105	370 U	360 U	390 U			
2,4,5-Trichlorophenol	UG/KG	0	0%	100	0	0	178	920 U	900 U	990 U	400 U	420 U	380 U
2,4,6-Trichlorophenol	UG/KG	0	0%		0	0	178	370 U	360 U	390 U	400 U	420 U	380 U
2,4-Dichlorophenol	UG/KG	0	0%	400	0	0	178	370 U	360 U	390 U	400 U	420 U	380 U
2,4-Dimethylphenol	UG/KG	0	0%		0	0	108	370 U	360 U	390 U			
2,4-Dinitrophenol	UG/KG	0	0%	200	0	0	178	920 UJ	900 U	990 UJ	2100 U	2100 U	1900 U
2,4-Dinitrotoluene	UG/KG	0	0%		0	0	178	370 U	360 U	390 U	400 U	420 U	380 U
2,6-Dinitrotoluene	UG/KG	0	0%	1000	0	0	178	370 U	360 U	390 U	400 U	420 U	380 U
2-Chloronaphthalene	UG/KG	0	0%		0	0	108	370 U	360 U	390 U			
2-Chlorophenol	UG/KG	0	0%	800	0	0	178	370 U	360 U	390 U	400 U	420 U	380 U
2-Methylnaphthalene	UG/KG	1295	19%	36400	0	34	178	370 U	360 U	390 U	400 U	420 U	380 U
2-Methylphenol	UG/KG	0	0%	100	0	0	178	370 U	360 U	390 U	400 U	420 U	380 U
2-Nitroaniline	UG/KG	0	0%	430	0	0	178	920 U	900 U	990 U	2100 U	2100 U	1900 U
2-Nitrophenol	UG/KG	0	0%	330	0	0	178	370 U	360 U	390 U	400 U	420 U	380 U
3,3'-Dichlorobenzidine	UG/KG	0	0%		0	0	178	370 U	360 U	390 U	400 U	420 U	380 U
3-Nitroaniline	UG/KG	0	0%	500	0	0	178	920 U	900 U	990 U	2100 U	2100 U	1900 U
4,6-Dinitro-2-methylphenol	UG/KG	0	0%		0	0	108	920 U	900 U	990 U			
4-Bromophenyl phenyl ether	UG/KG	0	0%		0	0	108	370 U	360 U	390 U			
4-Chloro-3-methylphenol	UG/KG	0	0%	240	0	0	178	370 U	360 U	390 U	400 U	420 U	380 U
4-Chloroaniline	UG/KG	1200	1%	220	1	2	178	370 UJ	360 UJ	390 UJ	400 U	420 U	380 U
4-Chlorophenyl phenyl ether	UG/KG	0	0%		0	0	108	370 U	360 U	390 U			
4-Methylphenol	UG/KG	150	3%	900	0	5	178	370 U	360 U	390 U	400 U	420 U	380 U
4-Nitroaniline	UG/KG	0	0%		0	0	108	920 UJ	900 U	990 UJ			
4-Nitrophenol	UG/KG	0	0%	100	0	0	178	920 U	900 U	990 U	2100 U	2100 U	1900 U
Acenaphthene	UG/KG	2680	24%	50000	0	42	178	370 U	360 U	390 U	400 U	420 U	380 U
Acenaphthylene	UG/KG	1700	37%	41000	0	66	178	370 U	360 U	390 U	400 U	420 U	380 U
Acetophenone	UG/KG	0	0%		0	0	99	370 U	360 U	390 U			
Aniline	UG/KG	0	0%		0	0	70				400 U	420 U	380 U
Anthracene	UG/KG	4395	43%	50000	0	77	178	370 U	360 U	390 U	400 U	420 U	380 U

Table A-2A
SURFACE SOIL SAMPLE RESULTS (0-2 ft.)
SEAD-59
SEAD-59 and SEAD-71 Phase II RI Report
Seneca Army Depot Activity

Facility	SEAD-59	SEAD-59	SEAD-59	SEAD-59	SEAD-59	SEAD-59							
Location ID	CL-59-02-WS2	CL-59-02-WW1	CL-59-02-WW2	CL-59-03-F01	CL-59-03-F02	CL-59-03-F03							
Maxtrix	SOIL	SOIL	SOIL	SOIL	SOIL	SOIL							
Sample ID	CL-59-02-WS2	CL-59-02-WW1	CL-59-02-WW2	CL-59-03-F01	CL-59-03-F02	CL-59-03-F03							
Sample Depth to Top of Sample ⁽¹⁾	0	0	0	0	0	0							
Sample Depth to Bottom of Sample ⁽¹⁾	0	0	0	0	0	0							
Sample Date	5/6/2004	5/6/2004	5/6/2004	5/6/2004	5/6/2004	5/6/2004							
QC Code	SA	SA	SA	SA	SA	SA							
Study ID	ENSR IRM	ENSR IRM	ENSR IRM	ENSR IRM	ENSR IRM	ENSR IRM							
Sample Round	1	1	1	1	1	1							
Parameter	Units	Maximum Value	Frequency of Detection	NYSDEC TAGM 4046 ⁽²⁾	Number of Exceedances	Number of Detects	Number of Analyses ⁽³⁾	Value (Q)	Value (Q)	Value (Q)	Value (Q)	Value (Q)	Value (Q)
Atrazine	UG/KG	120	1%		0	1	99	370 U	360 U	390 U			
Benzaldehyde	UG/KG	50	1%		0	1	99	370 UJ	360 UJ	390 UJ			
Benzo(a)anthracene	UG/KG	8900	51%	224	72	90	178	370 U	360 U	390 U	400 U	420 U	380 U
Benzo(a)pyrene	UG/KG	8050	51%	61	84	91	178	370 U	360 U	390 U	400 U	420 U	380 U
Benzo(b)fluoranthene	UG/KG	6800	52%	1100	40	92	178	370 U	360 U	390 U	400 U	420 U	380 U
Benzo(ghi)perylene	UG/KG	5200	46%	50000	0	82	178	370 U	360 U	390 U	400 U	420 U	380 U
Benzo(k)fluoranthene	UG/KG	7350	49%	1100	35	88	178	370 U	360 U	390 U	400 U	420 U	380 U
Benzoic Acid	UG/KG	0	0%	2700	0	0	70				2100 U	2100 U	1900 U
Bis(2-Chloroethoxy)methane	UG/KG	0	0%		0	0	108	370 U	360 U	390 U			
Bis(2-Chloroethyl)ether	UG/KG	0	0%		0	0	108	370 U	360 U	390 U			
Bis(2-Chloroisopropyl)ether	UG/KG	0	0%		0	0	3						
Bis(2-Ethylhexyl)phthalate	UG/KG	990	19%	50000	0	34	178	370 U	360 U	390 U	400 U	420 U	380 U
Butylbenzylphthalate	UG/KG	0	0%	50000	0	0	178	370 U	360 U	390 U	400 U	420 U	380 U
Caprolactam	UG/KG	0	0%		0	0	99	370 U	360 U	390 U			
Carbazole	UG/KG	755	19%		0	20	108	370 U	360 U	390 U			
Chrysene	UG/KG	8900	51%	400	62	91	178	370 U	360 U	390 U	400 U	420 U	380 U
Di-n-butylphthalate	UG/KG	965	2%	8100	0	4	178	370 U	360 U	390 U	400 U	420 U	380 U
Di-n-octylphthalate	UG/KG	0	0%	50000	0	0	178	370 U	360 U	390 U	400 U	420 U	380 U
Dibenz(a,h)anthracene	UG/KG	1665	38%	14	67	68	178	370 U	360 U	390 U	400 U	420 U	380 U
Dibenzofuran	UG/KG	2350	16%	6200	0	28	178	370 U	360 U	390 U	400 U	420 U	380 U
Diethyl phthalate	UG/KG	10	1%	7100	0	1	178	370 U	360 U	390 U	400 U	420 U	380 U
Dimethylphthalate	UG/KG	0	0%	2000	0	0	178	370 U	360 U	390 U	400 U	420 U	380 U
Fluoranthene	UG/KG	23500	54%	50000	0	97	178	370 U	360 U	390 U	400 U	420 U	380 U
Fluorene	UG/KG	2640	28%	50000	0	49	178	370 U	360 U	390 U	400 U	420 U	380 U
Hexachlorobenzene	UG/KG	0	0%	410	0	0	178	370 U	360 U	390 U	400 U	420 U	380 U
Hexachlorobutadiene	UG/KG	0	0%		0	0	178	370 U	360 U	390 U	400 U	420 U	380 U
Hexachlorocyclopentadiene	UG/KG	0	0%		0	0	108	370 U	360 U	390 U			
Hexachloroethane	UG/KG	0	0%		0	0	178	370 U	360 U	390 U	400 U	420 U	380 U
Indeno(1,2,3-cd)pyrene	UG/KG	4950	47%	3200	2	84	178	370 U	360 U	390 U	400 U	420 U	380 U
Isophorone	UG/KG	0	0%	4400	0	0	178	370 U	360 U	390 U	400 U	420 U	380 U
N-Nitrosodiphenylamine	UG/KG	100	1%		0	1	108	370 U	360 U	390 U			
N-Nitrosodipropylamine	UG/KG	0	0%		0	0	108	370 U	360 U	390 U			
Naphthalene	UG/KG	1800	19%	13000	0	34	178	370 U	360 U	390 U	400 U	420 U	380 U
Nitrobenzene	UG/KG	0	0%	200	0	0	178	370 U	360 U	390 U	400 U	420 U	380 U
Pentachlorophenol	UG/KG	0	0%	1000	0	0	178	920 U	900 U	990 U	2100 U	2100 U	1900 U
Phenanthrene	UG/KG	21300	51%	50000	0	90	178	370 U	360 U	390 U	400 U	420 U	380 U
Phenol	UG/KG	0	0%	30	0	0	178	370 U	360 U	390 U	400 U	420 U	380 U
Pyrene	UG/KG	19200	55%	50000	0	98	178	370 U	360 U	390 U	400 U	420 U	380 U
Pyridine	UG/KG	0	0%		0	0	100				2100 U	2100 U	1900 U
Total Unknown PAHs as SV	MG/KG	25	100%		0	3	3						
Pesticides/PCBs													
4,4'-DDD	UG/KG	740	28%	2900	0	49	178	3.6 U	3.5 U	3.9 U	20 U	21 U	19 U
4,4'-DDE	UG/KG	2600	37%	2100	1	65	178	3.6 U	3.5 U	3.9 U	20 U	21 U	19 U
4,4'-DDT	UG/KG	3700	33%	2100	1	59	178	3.6 U	3.5 U	3.9 U	20 U	21 U	19 U
Aldrin	UG/KG	1.2	1%	41	0	1	178	1.9 U	1.8 U	2 U	10 U	11 U	9.7 U

**Table A-2A
SURFACE SOIL SAMPLE RESULTS (0-2 ft.)
SEAD-59
SEAD-59 and SEAD-71 Phase II RI Report
Seneca Army Depot Activity**

Facility	SEAD-59						SEAD-59	SEAD-59	SEAD-59	SEAD-59	SEAD-59	SEAD-59	
Location ID	CL-59-02-WS2						CL-59-02-WW1	CL-59-02-WW2	CL-59-03-F01	CL-59-03-F02	CL-59-03-F03		
Maxtrix	SOIL						SOIL	SOIL	SOIL	SOIL	SOIL		
Sample ID	CL-59-02-WS2						CL-59-02-WW1	CL-59-02-WW2	CL-59-03-F01	CL-59-03-F02	CL-59-03-F03		
Sample Depth to Top of Sample ⁽¹⁾	0						0	0	0	0	0		
Sample Depth to Bottom of Sample ⁽¹⁾	0						0	0	0	0	0		
Sample Date	5/6/2004						5/6/2004	5/6/2004	5/6/2004	5/6/2004	5/6/2004		
QC Code	SA						SA	SA	SA	SA	SA		
Study ID	ENSR IRM						ENSR IRM	ENSR IRM	ENSR IRM	ENSR IRM	ENSR IRM		
Sample Round	1						1	1	1	1	1		
Parameter	Units	Maximum Value	Frequency of Detection	NYSDEC TAGM 4046 ⁽²⁾	Number of Exceedances	Number of Detects	Number of Analyses ⁽³⁾	Value (Q)	Value (Q)	Value (Q)	Value (Q)	Value (Q)	Value (Q)
Alpha-BHC	UG/KG	0	0%	110	0	0	178	1.9 U	1.8 U	2 U	10 U	11 U	9.7 U
Alpha-Chlordane	UG/KG	34	4%		0	7	178	1.9 U	1.8 U	2 U	10 U	11 U	9.7 U
Beta-BHC	UG/KG	2.4	1%	200	0	1	178	1.9 U	1.8 U	2 U	10 U	11 U	9.7 U
Delta-BHC	UG/KG	0	0%	300	0	0	178	1.9 U	1.8 U	2 U	10 U	11 U	9.7 U
Dieldrin	UG/KG	0	0%	44	0	0	178	3.6 U	3.5 U	3.9 U	20 U	21 U	19 U
Endosulfan I	UG/KG	16	1%	900	0	1	178	1.9 U	1.8 U	2 U	10 U	11 U	9.7 U
Endosulfan II	UG/KG	0	0%	900	0	0	178	3.6 U	3.5 U	3.9 U	20 U	21 U	19 U
Endosulfan sulfate	UG/KG	6.2	1%	1000	0	1	178	3.6 U	3.5 U	3.9 U	20 U	21 U	19 U
Endrin	UG/KG	16	2%	100	0	3	178	3.6 U	3.5 U	3.9 U	20 U	21 U	19 U
Endrin aldehyde	UG/KG	4.9	1%		0	2	178	3.6 U	3.5 U	3.9 U	20 U	21 U	19 U
Endrin ketone	UG/KG	38	2%		0	4	178	3.6 U	3.5 U	3.9 U	20 U	21 U	19 U
Gamma-BHC/Lindane	UG/KG	0	0%	60	0	0	178	1.9 U	1.8 U	2 U	10 U	11 U	9.7 U
Gamma-Chlordane	UG/KG	24	8%	540	0	14	178	1.9 U	1.8 U	2 U	10 U	11 U	9.7 U
Heptachlor	UG/KG	0	0%	100	0	0	178	1.9 U	1.8 U	2 U	10 U	11 U	9.7 U
Heptachlor epoxide	UG/KG	3	1%	20	0	2	178	1.9 U	1.8 U	2 U	10 U	11 U	9.7 U
Methoxychlor	UG/KG	0	0%		0	0	178	19 U	18 U	20 U	100 U	110 U	97 U
Toxaphene	UG/KG	0	0%		0	0	178	190 U	180 U	200 U	200 U	210 U	190 U
Aroclor-1016	UG/KG	0	0%		0	0	178	37 U	36 U	40 U	40 U	42 U	38 U
Aroclor-1221	UG/KG	0	0%		0	0	178	37 U	36 U	40 U	40 U	42 U	38 U
Aroclor-1232	UG/KG	0	0%		0	0	178	37 U	36 U	40 U	40 U	42 U	38 U
Aroclor-1242	UG/KG	0	0%		0	0	178	37 U	36 U	40 U	40 U	42 U	38 U
Aroclor-1248	UG/KG	0	0%		0	0	178	37 U	36 U	40 U	40 U	42 U	38 U
Aroclor-1254	UG/KG	0	0%	10000	0	0	178	37 U	36 U	40 U	40 U	42 U	38 U
Aroclor-1260	UG/KG	79	1%	10000	0	2	178	37 U	36 U	40 U	40 U	42 U	38 U
Metals													
Aluminum	MG/KG	18300	100%	19300	0	178	178	9600 J	9140 J	12600 J	8160	10600	9260
Antimony	MG/KG	424	58%	5.9	5	104	178	0.94 J	1.2 J	1.5 J	3.4 UJ	3.6 UJ	3.2 UJ
Arsenic	MG/KG	32.2	100%	8.2	7	178	178	4.7 J	4.8 J	7.7 J	4.8	5.6	4.8
Barium	MG/KG	304	100%	300	1	178	178	68.5 J	88.8 J	129 J	51.1	72.3	77.9
Beryllium	MG/KG	2.6	99%	1.1	2	176	178	0.46	0.48	0.68	0.12	0.26	0.19
Cadmium	MG/KG	3.2	86%	2.3	2	153	178	0.23 J	0.33	0.33	0.29 U	0.3 U	0.27 U
Calcium	MG/KG	214000	100%	121000	1	178	178	52000 J	77100 J	3780 J	13200	13000	71900
Chromium	MG/KG	39.3	100%	29.6	2	178	178	14.7 J	13.8 J	19 J	14.3	19.1	14.9
Cobalt	MG/KG	47.8	100%	30	2	178	178	6.7 J	6.8 J	13.3 J	7.8	12.2	8.4
Copper	MG/KG	305	100%	33	19	178	178	21.4 J	18 J	22 J	22.6	22.9	19.5
Cyanide	MG/KG	0	0%	0.35	0	0	9						
Iron	MG/KG	64000	100%	36500	1	178	178	18800 J	20200 J	26200 J	19600	24400	19800
Lead	MG/KG	164	100%	24.8	75	178	178	7.9 J	11.3 J	14.7 J	11.6 J	14.2 J	14.5 J
Magnesium	MG/KG	30200	100%	21500	3	178	178	9750 J	8110 J	4600 J	4430	6220	15100
Manganese	MG/KG	1290	100%	1060	3	178	178	324 J	208 J	780 J	281	462	440
Mercury	MG/KG	0.95	95%	0.1	37	169	178	0.05 J	0.14 J	0.09 J	0.03 J	0.04	0.03 J
Nickel	MG/KG	88.3	100%	49	3	178	178	22.9 J	20.5 J	32.3 J	25.9	32	24.9
Potassium	MG/KG	2290	100%	2380	0	178	178	968 J	661 J	979 J	971	980	888
Selenium	MG/KG	1.5	9%	2	0	16	178	0.43 U	0.41 U	0.47 U	0.57 U	0.6 U	0.54 U
Silver	MG/KG	2.9	49%	0.75	62	87	178	1.1 J	0.54 J	2.6 J	0.57 U	0.6 U	0.54 U
Sodium	MG/KG	4060	99%	172	86	177	178	152 J	97.1 J	43.6 J	103	98.4	241

**Table A-2A
SURFACE SOIL SAMPLE RESULTS (0-2 ft.)
SEAD-59
SEAD-59 and SEAD-71 Phase II RI Report
Seneca Army Depot Activity**

				SEAD-59	SEAD-59	SEAD-59	SEAD-59	SEAD-59	SEAD-59	SEAD-59	SEAD-59		
				CL-59-02-WS2	CL-59-02-WW1	CL-59-02-WW2	CL-59-03-F01	CL-59-03-F02	CL-59-03-F03	CL-59-03-F02	CL-59-03-F03		
				SOIL	SOIL	SOIL	SOIL	SOIL	SOIL	SOIL	SOIL		
				CL-59-02-WS2	CL-59-02-WW1	CL-59-02-WW2	CL-59-03-F01	CL-59-03-F02	CL-59-03-F03	CL-59-03-F02	CL-59-03-F03		
Sample Depth to Top of Sample ⁽¹⁾				0	0	0	0	0	0	0	0		
Sample Depth to Bottom of Sample ⁽¹⁾				0	0	0	0	0	0	0	0		
Sample Date				5/6/2004	5/6/2004	5/6/2004	5/6/2004	5/6/2004	5/6/2004	5/6/2004	5/6/2004		
QC Code				SA	SA	SA	SA	SA	SA	SA	SA		
Study ID				ENSR IRM	ENSR IRM	ENSR IRM	ENSR IRM	ENSR IRM	ENSR IRM	ENSR IRM	ENSR IRM		
Sample Round				1	1	1	1	1	1	1	1		
Parameter	Units	Maximum Value	Frequency of Detection	NYSDEC TAGM 4046 ⁽²⁾	Number of Exceedances	Number of Detects	Number of Analyses ⁽³⁾	Value (Q)	Value (Q)	Value (Q)	Value (Q)	Value (Q)	Value (Q)
Thallium	MG/KG	1.8	29%	0.7	24	51	178	0.21 U	0.2 U	0.23 U	0.57 U	0.6 U	0.54 U
Vanadium	MG/KG	28.5	100%	150	0	178	178	15.6 J	14.5 J	21.9 J	14.9	17	15.7
Zinc	MG/KG	341	100%	110	19	178	178	57.9 J	43.5 J	60.9 J	85 J	120 J	64.4 J

Note(s):

(1) - Historical sample depths are presented (I.e. prior to 2002 TCRA)

(2) - NYSDEC Technical and Administrative Guidance Memorandum (TAGM) HWR-94-4046, Revised January 24, 1994

(3) - Sample/Duplicate pair are presented as individual samples in this table. Statistical information used Sample Duplicate pairs as a single entity and averaged result values were used in risk assessment analysis.

U = compound was not detected

J = the reported value is an estimated concentration

UJ = the compound was not detected; the associated reporting limit is approximate

R = the data was rejected in the data validating process

NJ = compound was "tentatively identified" and the associated numerical value is approximate

**Table A-2A
SURFACE SOIL SAMPLE RESULTS (0-2 ft.)
SEAD-59
SEAD-59 and SEAD-71 Phase II RI Report
Seneca Army Depot Activity**

Facility	SEAD-59						SEAD-59						
Location ID	CL-59-03-WE1		CL-59-03-WN1		CL-59-03-WN2		CL-59-03-WN3		CL-59-03-WS1		CL-59-03-WS2		
Maxtrix	SOIL						SOIL						
Sample ID	CL-59-03-WE1		CL-59-03-WN1		CL-59-03-WN2		CL-59-03-WN3		CL-59-03-WS1		CL-59-03-WS2		
Sample Depth to Top of Sample ⁽¹⁾	0						0						
Sample Depth to Bottom of Sample ⁽¹⁾	0						0						
Sample Date	5/6/2004		5/6/2004		5/6/2004		5/6/2004		5/6/2004		5/6/2004		
QC Code	SA		SA		SA		SA		SA		SA		
Study ID	ENSR IRM		ENSR IRM		ENSR IRM		ENSR IRM		ENSR IRM		ENSR IRM		
Sample Round	1		1		1		1		1		1		
Parameter	Units	Maximum Value	Frequency of Detection	NYSDEC TAGM 4046 ⁽²⁾	Number of Exceedances	Number of Detects	Number of Analyses ⁽³⁾	Value (Q)	Value (Q)	Value (Q)	Value (Q)	Value (Q)	Value (Q)
Volatile Organics													
1,1,1-Trichloroethane	UG/KG	0	0%	800	0	0	177	5 U	5 U	5 U	5 U	5 U	5 U
1,1,2,2-Tetrachloroethane	UG/KG	0	0%	600	0	0	169	5 U	5 U	5 U	5 U	5 U	5 U
1,1,2-Trichloro-1,2,2-Trifluoroethane	UG/KG	0	0%		0	0	168	5 U	5 U	5 U	5 U	5 U	5 U
1,1,2-Trichloroethane	UG/KG	0	0%		0	0	107	5 U	5 U	5 U	5 U	5 U	5 U
1,1-Dichloroethane	UG/KG	0	0%	200	0	0	177	5 U	5 U	5 U	5 U	5 U	5 U
1,1-Dichloroethene	UG/KG	8	2%	400	0	3	177	5 U	5 U	5 U	5 U	5 U	5 U
1,2,3-Trichloropropane	UG/KG	0	0%		0	0	70						
1,2,4-Trichlorobenzene	UG/KG	0	0%	3400	0	0	161	5 U	5 U	5 U	5 U	5 U	5 U
1,2-Dibromo-3-chloropropane	UG/KG	0	0%		0	0	91	5 U	5 U	5 U	5 U	5 U	5 U
1,2-Dibromoethane	UG/KG	0	0%		0	0	98	5 U	5 U	5 U	5 U	5 U	5 U
1,2-Dichlorobenzene	UG/KG	0	0%	7900	0	0	161	5 U	5 U	5 U	5 U	5 U	5 U
1,2-Dichloroethane	UG/KG	0	0%	100	0	0	177	5 U	5 U	5 U	5 U	5 U	5 U
1,2-Dichloroethene (total)	UG/KG	0	0%		0	0	9						
1,2-Dichloropropane	UG/KG	0	0%		0	0	107	5 U	5 U	5 U	5 U	5 U	5 U
1,3-Dichlorobenzene	UG/KG	0	0%	1600	0	0	161	5 U	5 U	5 U	5 U	5 U	5 U
1,3-Dichloropropane	UG/KG	0	0%		0	0	70						
1,4-Dichlorobenzene	UG/KG	0	0%	8500	0	0	161	5 U	5 U	5 U	5 U	5 U	5 U
Acetone	UG/KG	550	27%	200	2	47	177	5 U	5 U	5 U	5 U	5 U	5 U
Benzene	UG/KG	3	4%	60	7	7	177	5 U	5 U	5 U	5 U	5 U	5 U
Bromodichloromethane	UG/KG	0	0%		0	0	107	5 U	5 U	5 U	5 U	5 U	5 U
Bromoform	UG/KG	0	0%		0	0	107	5 U	5 U	5 U	5 U	5 U	5 U
Carbon disulfide	UG/KG	4	3%	2700	0	6	177	5 U	5 U	5 U	5 U	5 U	5 U
Carbon tetrachloride	UG/KG	0	0%	600	0	0	177	5 U	5 U	5 U	5 U	5 U	5 U
Chlorobenzene	UG/KG	0	0%	1700	0	0	177	5 U	5 U	5 U	5 U	5 U	5 U
Chlorodibromomethane	UG/KG	0	0%		0	0	177	5 U	5 U	5 U	5 U	5 U	5 U
Chloroethane	UG/KG	0	0%	1900	0	0	177	5 U	5 U	5 U	5 U	5 U	5 U
Chloroform	UG/KG	0	0%	300	0	0	177	5 U	5 U	5 U	5 U	5 U	5 U
Cis-1,2-Dichloroethene	UG/KG	0	0%		0	0	98	5 U	5 U	5 U	5 U	5 U	5 U
Cis-1,3-Dichloropropene	UG/KG	0	0%		0	0	107	5 U	5 U	5 U	5 U	5 U	5 U
Cyclohexane	UG/KG	3	8%		0	8	98	5 U	5 U	5 U	5 U	5 U	5 U
Dichlorodifluoromethane	UG/KG	0	0%		0	0	98	5 U	5 U	5 U	5 U	5 U	5 U
Ethyl benzene	UG/KG	4.6	1%	5500	0	2	177	5 U	5 U	5 U	5 U	5 U	5 U
Isopropylbenzene	UG/KG	0	0%		0	0	98	5 U	5 U	5 U	5 U	5 U	5 U
Meta/Para Xylene	UG/KG	9.4	4%		0	3	70						
Methyl Acetate	UG/KG	2	3%		0	3	98	5 U	5 U	5 U	5 U	5 U	5 U
Methyl Tertbutyl Ether	UG/KG	0	0%		0	0	98	5 U	5 U	5 U	5 U	5 U	5 U
Methyl bromide	UG/KG	0	0%		0	0	107	5 U	5 U	5 U	5 U	5 U	5 U
Methyl butyl ketone	UG/KG	0	0%		0	0	107	5 U	5 U	5 U	5 U	5 U	5 U
Methyl chloride	UG/KG	0	0%		0	0	107	5 U	5 U	5 U	5 U	5 U	5 U
Methyl cyclohexane	UG/KG	5	10%		0	10	98	5 U	5 U	5 U	5 U	5 U	5 U
Methyl ethyl ketone	UG/KG	190	12%	300	0	22	177	5 U	5 U	5 U	5 U	5 U	5 U
Methyl isobutyl ketone	UG/KG	1.9	1%	1000	0	1	177	5 U	5 U	5 U	5 U	5 U	5 U
Methylene chloride	UG/KG	4.9	20%	100	0	36	178	1 J	1 J	2 J	2 J	2 J	2 J
Ortho Xylene	UG/KG	5.05	4%		0	3	70						

Table A-2A
SURFACE SOIL SAMPLE RESULTS (0-2 ft.)
SEAD-59
SEAD-59 and SEAD-71 Phase II RI Report
Seneca Army Depot Activity

Facility	SEAD-59						SEAD-59						
Location ID	CL-59-03-WE1		CL-59-03-WN1		CL-59-03-WN2		CL-59-03-WN3		CL-59-03-WS1		CL-59-03-WS2		
Maxtrix	SOIL						SOIL						
Sample ID	CL-59-03-WE1		CL-59-03-WN1		CL-59-03-WN2		CL-59-03-WN3		CL-59-03-WS1		CL-59-03-WS2		
Sample Depth to Top of Sample ⁽¹⁾	0						0						
Sample Depth to Bottom of Sample ⁽¹⁾	0						0						
Sample Date	5/6/2004		5/6/2004		5/6/2004		5/6/2004		5/6/2004		5/6/2004		
QC Code	SA		SA		SA		SA		SA		SA		
Study ID	ENSR IRM		ENSR IRM		ENSR IRM		ENSR IRM		ENSR IRM		ENSR IRM		
Sample Round	1		1		1		1		1		1		
Parameter	Units	Maximum Value	Frequency of Detection	NYSDEC TAGM 4046 ⁽²⁾	Number of Exceedances	Number of Detects	Number of Analyses ⁽³⁾	Value (Q)	Value (Q)	Value (Q)	Value (Q)	Value (Q)	Value (Q)
Styrene	UG/KG	0	0%		0	0	107	5 U	5 U	5 U	5 U	5 U	5 U
Tetrachloroethene	UG/KG	6.4	3%	1400	0	5	177	5 U	5 U	5 U	5 U	5 U	5 U
Toluene	UG/KG	8	8%	1500	0	14	177	5 U	5 U	5 U	5 U	5 U	5 U
Total BTEX	MG/KG	3.25	67%		0	2	3						
Total Xylenes	UG/KG	3	7%	1200	0	7	102	5 U	5 U	5 U	5 U	5 U	5 U
Trans-1,2-Dichloroethene	UG/KG	0	0%	300	0	0	168	5 U	5 U	5 U	5 U	5 U	5 U
Trans-1,3-Dichloropropene	UG/KG	0	0%		0	0	107	5 U	5 U	5 U	5 U	5 U	5 U
Trichloroethene	UG/KG	4.5	5%	700	0	8	177	5 U	5 U	5 U	5 U	5 U	5 U
Trichlorofluoromethane	UG/KG	6	1%		0	1	98	5 U	5 U	5 U	5 U	5 U	5 U
Vinyl chloride	UG/KG	0	0%	200	0	0	177	5 U	5 U	5 U	5 U	5 U	5 U
Semivolatile Organics													
1,1'-Biphenyl	UG/KG	254.5	2%		0	2	99	370 U	360 U	350 U	370 U	360 U	350 U
1,2,4-Trichlorobenzene	UG/KG	0	0%	3400	0	0	9						
1,2-Dichlorobenzene	UG/KG	0	0%	7900	0	0	9						
1,3-Dichlorobenzene	UG/KG	0	0%	1600	0	0	9						
1,4-Dichlorobenzene	UG/KG	0	0%	8500	0	0	9						
2,2'-oxybis(1-Chloropropane)	UG/KG	0	0%		0	0	105	370 U	360 U	350 U	370 U	360 U	350 U
2,4,5-Trichlorophenol	UG/KG	0	0%	100	0	0	178	930 U	910 U	870 U	920 U	910 U	880 U
2,4,6-Trichlorophenol	UG/KG	0	0%		0	0	178	370 U	360 U	350 U	370 U	360 U	350 U
2,4-Dichlorophenol	UG/KG	0	0%	400	0	0	178	370 U	360 U	350 U	370 U	360 U	350 U
2,4-Dimethylphenol	UG/KG	0	0%		0	0	108	370 U	360 U	350 U	370 U	360 U	350 U
2,4-Dinitrophenol	UG/KG	0	0%	200	0	0	178	930 U	910 U	870 U	920 UJ	910 UJ	880 U
2,4-Dinitrotoluene	UG/KG	0	0%		0	0	178	370 U	360 U	350 U	370 U	360 U	350 U
2,6-Dinitrotoluene	UG/KG	0	0%	1000	0	0	178	370 U	360 U	350 U	370 U	360 U	350 U
2-Chloronaphthalene	UG/KG	0	0%		0	0	108	370 U	360 U	350 U	370 U	360 U	350 U
2-Chlorophenol	UG/KG	0	0%	800	0	0	178	370 U	360 U	350 U	370 U	360 U	350 U
2-Methylnaphthalene	UG/KG	1295	19%	36400	0	34	178	370 U	360 U	350 U	370 U	360 U	350 U
2-Methylphenol	UG/KG	0	0%	100	0	0	178	370 U	360 U	350 U	370 U	360 U	350 U
2-Nitroaniline	UG/KG	0	0%	430	0	0	178	930 U	910 U	870 U	920 U	910 U	880 U
2-Nitrophenol	UG/KG	0	0%	330	0	0	178	370 U	360 U	350 U	370 U	360 U	350 U
3,3'-Dichlorobenzidine	UG/KG	0	0%		0	0	178	370 U	360 U	350 U	370 U	360 U	350 U
3-Nitroaniline	UG/KG	0	0%	500	0	0	178	930 U	910 U	870 U	920 U	910 U	880 U
4,6-Dinitro-2-methylphenol	UG/KG	0	0%		0	0	108	930 U	910 U	870 U	920 U	910 U	880 U
4-Bromophenyl phenyl ether	UG/KG	0	0%		0	0	108	370 U	360 U	350 U	370 U	360 U	350 U
4-Chloro-3-methylphenol	UG/KG	0	0%	240	0	0	178	370 U	360 U	350 U	370 U	360 U	350 U
4-Chloroaniline	UG/KG	1200	1%	220	1	2	178	370 UJ	360 UJ	350 UJ	370 UJ	360 UJ	350 UJ
4-Chlorophenyl phenyl ether	UG/KG	0	0%		0	0	108	370 U	360 U	350 U	370 U	360 U	350 U
4-Methylphenol	UG/KG	150	3%	900	0	5	178	370 U	360 U	350 U	370 U	360 U	350 U
4-Nitroaniline	UG/KG	0	0%		0	0	108	930 U	910 U	870 U	920 UJ	910 UJ	880 U
4-Nitrophenol	UG/KG	0	0%	100	0	0	178	930 U	910 U	870 U	920 U	910 U	880 U
Acenaphthene	UG/KG	2680	24%	50000	0	42	178	370 U	360 U	350 U	370 U	360 U	350 U
Acenaphthylene	UG/KG	1700	37%	41000	0	66	178	370 U	360 U	350 U	370 U	360 U	350 U
Acetophenone	UG/KG	0	0%		0	0	99	370 U	360 U	350 U	370 U	360 U	350 U
Aniline	UG/KG	0	0%		0	0	70						
Anthracene	UG/KG	4395	43%	50000	0	77	178	370 U	360 U	350 U	370 U	360 U	350 U

Table A-2A
SURFACE SOIL SAMPLE RESULTS (0-2 ft.)
SEAD-59
SEAD-59 and SEAD-71 Phase II RI Report
Seneca Army Depot Activity

Facility	SEAD-59						SEAD-59	SEAD-59	SEAD-59	SEAD-59	SEAD-59	SEAD-59	
Location ID	CL-59-03-WE1						CL-59-03-WN1	CL-59-03-WN2	CL-59-03-WN3	CL-59-03-WS1	CL-59-03-WS2	CL-59-03-WS2	
Maxtrix	SOIL						SOIL	SOIL	SOIL	SOIL	SOIL	SOIL	
Sample ID	CL-59-03-WE1						CL-59-03-WN1	CL-59-03-WN2	CL-59-03-WN3	CL-59-03-WS1	CL-59-03-WS2	CL-59-03-WS2	
Sample Depth to Top of Sample ⁽¹⁾	0						0	0	0	0	0	0	
Sample Depth to Bottom of Sample ⁽¹⁾	0						0	0	0	0	0	0	
Sample Date	5/6/2004						5/6/2004	5/6/2004	5/6/2004	5/6/2004	5/6/2004	5/6/2004	
QC Code	SA						SA	SA	SA	SA	SA	SA	
Study ID	ENSR IRM						ENSR IRM	ENSR IRM	ENSR IRM	ENSR IRM	ENSR IRM	ENSR IRM	
Sample Round	1						1	1	1	1	1	1	
Parameter	Units	Maximum Value	Frequency of Detection	NYSDEC TAGM 4046 ⁽²⁾	Number of Exceedances	Number of Detects	Number of Analyses ⁽³⁾	Value (Q)	Value (Q)	Value (Q)	Value (Q)	Value (Q)	Value (Q)
Atrazine	UG/KG	120	1%		0	1	99	370 U	360 U	350 U	370 U	360 U	350 U
Benzaldehyde	UG/KG	50	1%		0	1	99	370 UJ	360 UJ	350 UJ	370 UJ	360 UJ	350 UJ
Benzo(a)anthracene	UG/KG	8900	51%	224	72	90	178	370 U	360 U	350 U	370 U	360 U	350 U
Benzo(a)pyrene	UG/KG	8050	51%	61	84	91	178	370 U	360 U	350 U	370 U	360 U	350 U
Benzo(b)fluoranthene	UG/KG	6800	52%	1100	40	92	178	370 U	360 U	350 U	370 U	360 U	350 U
Benzo(ghi)perylene	UG/KG	5200	46%	50000	0	82	178	370 U	360 U	350 U	370 U	360 U	350 U
Benzo(k)fluoranthene	UG/KG	7350	49%	1100	35	88	178	370 U	360 U	350 U	370 U	360 U	350 U
Benzoic Acid	UG/KG	0	0%	2700	0	0	70						
Bis(2-Chloroethoxy)methane	UG/KG	0	0%		0	0	108	370 U	360 U	350 U	370 U	360 U	350 U
Bis(2-Chloroethyl)ether	UG/KG	0	0%		0	0	108	370 U	360 U	350 U	370 U	360 U	350 U
Bis(2-Chloroisopropyl)ether	UG/KG	0	0%		0	0	3						
Bis(2-Ethylhexyl)phthalate	UG/KG	990	19%	50000	0	34	178	370 U	360 U	350 U	370 U	360 U	350 U
Butylbenzylphthalate	UG/KG	0	0%	50000	0	0	178	370 U	360 U	350 U	370 U	360 U	350 U
Caprolactam	UG/KG	0	0%		0	0	99	370 U	360 U	350 U	370 U	360 U	350 U
Carbazole	UG/KG	755	19%		0	20	108	370 U	360 U	350 U	370 U	360 U	350 U
Chrysene	UG/KG	8900	51%	400	62	91	178	370 U	360 U	350 U	370 U	360 U	350 U
Di-n-butylphthalate	UG/KG	965	2%	8100	0	4	178	370 U	360 U	350 U	370 U	360 U	350 U
Di-n-octylphthalate	UG/KG	0	0%	50000	0	0	178	370 U	360 U	350 U	370 U	360 U	350 U
Dibenz(a,h)anthracene	UG/KG	1665	38%	14	67	68	178	370 U	360 U	350 U	370 U	360 U	350 U
Dibenzofuran	UG/KG	2350	16%	6200	0	28	178	370 U	360 U	350 U	370 U	360 U	350 U
Diethyl phthalate	UG/KG	10	1%	7100	0	1	178	370 U	360 U	350 U	370 U	360 U	350 U
Dimethylphthalate	UG/KG	0	0%	2000	0	0	178	370 U	360 U	350 U	370 U	360 U	350 U
Fluoranthene	UG/KG	23500	54%	50000	0	97	178	370 U	360 U	350 U	370 U	360 U	350 U
Fluorene	UG/KG	2640	28%	50000	0	49	178	370 U	360 U	350 U	370 U	360 U	350 U
Hexachlorobenzene	UG/KG	0	0%	410	0	0	178	370 U	360 U	350 U	370 U	360 U	350 U
Hexachlorobutadiene	UG/KG	0	0%		0	0	178	370 U	360 U	350 U	370 U	360 U	350 U
Hexachlorocyclopentadiene	UG/KG	0	0%		0	0	108	370 U	360 U	350 U	370 U	360 U	350 U
Hexachloroethane	UG/KG	0	0%		0	0	178	370 U	360 U	350 U	370 U	360 U	350 U
Indeno(1,2,3-cd)pyrene	UG/KG	4950	47%	3200	2	84	178	370 U	360 U	350 U	370 U	360 U	350 U
Isophorone	UG/KG	0	0%	4400	0	0	178	370 U	360 U	350 U	370 U	360 U	350 U
N-Nitrosodiphenylamine	UG/KG	100	1%		0	1	108	370 U	360 U	350 U	370 U	360 U	350 U
N-Nitrosodipropylamine	UG/KG	0	0%		0	0	108	370 U	360 U	350 U	370 U	360 U	350 U
Naphthalene	UG/KG	1800	19%	13000	0	34	178	370 U	360 U	350 U	370 U	360 U	350 U
Nitrobenzene	UG/KG	0	0%	200	0	0	178	370 U	360 U	350 U	370 U	360 U	350 U
Pentachlorophenol	UG/KG	0	0%	1000	0	0	178	930 U	910 U	870 U	920 U	910 U	880 U
Phenanthrene	UG/KG	21300	51%	50000	0	90	178	370 U	360 U	350 U	370 U	360 U	350 U
Phenol	UG/KG	0	0%	30	0	0	178	370 U	360 U	350 U	370 U	360 U	350 U
Pyrene	UG/KG	19200	55%	50000	0	98	178	370 U	360 U	350 U	370 U	360 U	350 U
Pyridine	UG/KG	0	0%		0	0	100						
Total Unknown PAHs as SV	MG/KG	25	100%		0	3	3						
Pesticides/PCBs													
4,4'-DDD	UG/KG	740	28%	2900	0	49	178	3.6 U	3.7 U	3.4 U	3.6 U	3.6 U	3.5 U
4,4'-DDE	UG/KG	2600	37%	2100	1	65	178	3.6 U	3.7 U	3.4 U	3.6 U	3.6 U	7.6 J
4,4'-DDT	UG/KG	3700	33%	2100	1	59	178	3.6 U	3.7 U	3.4 U	3.6 U	3.6 U	7.5
Aldrin	UG/KG	1.2	1%	41	0	1	178	1.9 U	1.9 U	1.8 U	1.9 U	1.9 U	1.8 U

Table A-2A
SURFACE SOIL SAMPLE RESULTS (0-2 ft.)
SEAD-59
SEAD-59 and SEAD-71 Phase II RI Report
Seneca Army Depot Activity

Facility	SEAD-59						SEAD-59						
Location ID	CL-59-03-WE1		CL-59-03-WN1		CL-59-03-WN2		CL-59-03-WN3		CL-59-03-WS1		CL-59-03-WS2		
Maxtrix	SOIL						SOIL						
Sample ID	CL-59-03-WE1		CL-59-03-WN1		CL-59-03-WN2		CL-59-03-WN3		CL-59-03-WS1		CL-59-03-WS2		
Sample Depth to Top of Sample ⁽¹⁾	0						0						
Sample Depth to Bottom of Sample ⁽¹⁾	0						0						
Sample Date	5/6/2004		5/6/2004		5/6/2004		5/6/2004		5/6/2004		5/6/2004		
QC Code	SA		SA		SA		SA		SA		SA		
Study ID	ENSR IRM		ENSR IRM		ENSR IRM		ENSR IRM		ENSR IRM		ENSR IRM		
Sample Round	1		1		1		1		1		1		
Parameter	Units	Maximum Value	Frequency of Detection	NYSDEC TAGM 4046 ⁽²⁾	Number of Exceedances	Number of Detects	Number of Analyses ⁽³⁾	Value (Q)	Value (Q)	Value (Q)	Value (Q)	Value (Q)	Value (Q)
Alpha-BHC	UG/KG	0	0%	110	0	0	178	1.9 U	1.9 U	1.8 U	1.9 U	1.9 U	1.8 U
Alpha-Chlordane	UG/KG	34	4%		0	7	178	1.9 U	1.9 U	1.8 U	1.9 U	1.9 U	1.8 U
Beta-BHC	UG/KG	2.4	1%	200	0	1	178	1.9 U	1.9 U	1.8 U	1.9 U	1.9 U	1.8 U
Delta-BHC	UG/KG	0	0%	300	0	0	178	1.9 U	1.9 U	1.8 U	1.9 U	1.9 U	1.8 U
Dieldrin	UG/KG	0	0%	44	0	0	178	3.6 U	3.7 U	3.4 U	3.6 U	3.6 U	3.5 U
Endosulfan I	UG/KG	16	1%	900	0	1	178	1.9 U	1.9 U	1.8 U	1.9 U	1.9 U	1.8 U
Endosulfan II	UG/KG	0	0%	900	0	0	178	3.6 U	3.7 U	3.4 U	3.6 U	3.6 U	3.5 U
Endosulfan sulfate	UG/KG	6.2	1%	1000	0	1	178	3.6 U	3.7 U	3.4 U	3.6 U	3.6 U	3.5 U
Endrin	UG/KG	16	2%	100	0	3	178	3.6 U	3.7 U	3.4 U	3.6 U	3.6 U	3.5 U
Endrin aldehyde	UG/KG	4.9	1%		0	2	178	3.6 U	3.7 U	3.4 U	3.6 U	3.6 U	3.5 U
Endrin ketone	UG/KG	38	2%		0	4	178	3.6 U	3.7 U	3.4 U	3.6 U	3.6 U	3.5 U
Gamma-BHC/Lindane	UG/KG	0	0%	60	0	0	178	1.9 U	1.9 U	1.8 U	1.9 U	1.9 U	1.8 U
Gamma-Chlordane	UG/KG	24	8%	540	0	14	178	1.9 U	1.9 U	1.8 U	1.9 U	1.9 U	1.8 U
Heptachlor	UG/KG	0	0%	100	0	0	178	1.9 U	1.9 U	1.8 U	1.9 U	1.9 U	1.8 U
Heptachlor epoxide	UG/KG	3	1%	20	0	2	178	1.9 U	1.9 U	1.8 U	1.9 U	1.9 U	1.8 U
Methoxychlor	UG/KG	0	0%		0	0	178	19 U	19 U	18 U	19 U	19 U	18 U
Toxaphene	UG/KG	0	0%		0	0	178	190 UJ	190 UJ	180 UJ	190 UJ	190 UJ	180 UJ
Aroclor-1016	UG/KG	0	0%		0	0	178	37 U	37 U	35 U	37 U	36 U	35 U
Aroclor-1221	UG/KG	0	0%		0	0	178	37 U	37 U	35 U	37 U	36 U	35 U
Aroclor-1232	UG/KG	0	0%		0	0	178	37 U	37 U	35 U	37 U	36 U	35 U
Aroclor-1242	UG/KG	0	0%		0	0	178	37 U	37 U	35 U	37 U	36 U	35 U
Aroclor-1248	UG/KG	0	0%		0	0	178	37 U	37 U	35 U	37 U	36 U	35 U
Aroclor-1254	UG/KG	0	0%	10000	0	0	178	37 U	37 U	35 U	37 U	36 U	35 U
Aroclor-1260	UG/KG	79	1%	10000	0	2	178	37 U	37 U	35 U	37 U	36 U	35 U
Metals													
Aluminum	MG/KG	18300	100%	19300	0	178	178	14500 J	13500 J	8530 J	4960 J	5420 J	5280 J
Antimony	MG/KG	424	58%	5.9	5	104	178	1.2 J	1.2 J	1.4 J	0.9 J	0.68 J	0.73 J
Arsenic	MG/KG	32.2	100%	8.2	7	178	178	6.5 J	7.5 J	5.9 J	4.2 J	3.6 J	2.8 J
Barium	MG/KG	304	100%	300	1	178	178	128 J	125 J	47.1 J	29.4 J	51.7 J	34.8 J
Beryllium	MG/KG	2.6	99%	1.1	2	176	178	0.74	0.76	0.4	0.26 J	0.26	0.25 J
Cadmium	MG/KG	3.2	86%	2.3	2	153	178	0.23 J	0.24 J	0.22 J	0.16 J	0.17 J	0.22 J
Calcium	MG/KG	214000	100%	121000	1	178	178	3130 J	3130 J	23920	74900 J	82700 J	90200 J
Chromium	MG/KG	39.3	100%	29.6	2	178	178	21.9 J	20.5 J	13.7 J	8.5 J	8.2 J	8.3 J
Cobalt	MG/KG	47.8	100%	30	2	178	178	7.8 J	8.2 J	11.1 J	6.3 J	4.6 J	4.3 J
Copper	MG/KG	305	100%	33	178	178	178	16.9 J	18.4 J	15.7 J	15.6 J	13.4 J	10.1 J
Cyanide	MG/KG	0	0%	0.35	0	0	9						
Iron	MG/KG	64000	100%	36500	1	178	178	25700 J	26400 J	8850 J	14600 J	12900 J	12200 J
Lead	MG/KG	164	100%	24.8	75	178	178	11.8 J	13.2 J	9.7 J	6.1 J	5.8 J	4.6 J
Magnesium	MG/KG	30200	100%	21500	3	178	178	4560 J	4120 J	8870 J	11300 J	15500 J	10600 J
Manganese	MG/KG	1290	100%	1060	3	178	178	193 J	249 J	476 J	365 J	380 J	265 J
Mercury	MG/KG	0.95	95%	0.1	37	169	178	0.08 J	0.43 J	0.06 J	0.13 J	0.11 J	0.04 J
Nickel	MG/KG	88.3	100%	49	3	178	178	28.2 J	27.8 J	27 J	17.6 J	15.4 J	14 J
Potassium	MG/KG	2290	100%	2380	0	178	178	994 J	922 J	699 J	595 J	631 J	539 J
Selenium	MG/KG	1.5	9%	2	0	16	178	0.45 U	0.45 U	0.38 U	0.43 U	0.39 U	0.39 U
Silver	MG/KG	2.9	49%	0.75	62	87	178	2.4 J	2.5 J	1.1 J	0.37 J	0.1 U	0.1 U
Sodium	MG/KG	4060	99%	172	86	177	178	36.3 J	33.3 J	107 J	107 J	140 J	121 J

**Table A-2A
SURFACE SOIL SAMPLE RESULTS (0-2 ft.)
SEAD-59
SEAD-59 and SEAD-71 Phase II RI Report
Seneca Army Depot Activity**

				SEAD-59	SEAD-59	SEAD-59	SEAD-59	SEAD-59	SEAD-59	SEAD-59	SEAD-59		
				CL-59-03-WE1	CL-59-03-WN1	CL-59-03-WN2	CL-59-03-WN3	CL-59-03-WS1	CL-59-03-WS2	CL-59-03-WS1	CL-59-03-WS2		
				SOIL	SOIL	SOIL	SOIL	SOIL	SOIL	SOIL	SOIL		
				CL-59-03-WE1	CL-59-03-WN1	CL-59-03-WN2	CL-59-03-WN3	CL-59-03-WS1	CL-59-03-WS2	CL-59-03-WS1	CL-59-03-WS2		
Sample Depth to Top of Sample ⁽¹⁾				0	0	0	0	0	0	0	0		
Sample Depth to Bottom of Sample ⁽¹⁾				0	0	0	0	0	0	0	0		
Sample Date				5/6/2004	5/6/2004	5/6/2004	5/6/2004	5/6/2004	5/6/2004	5/6/2004	5/6/2004		
QC Code				SA	SA	SA	SA	SA	SA	SA	SA		
Study ID				ENSR IRM	ENSR IRM	ENSR IRM	ENSR IRM	ENSR IRM	ENSR IRM	ENSR IRM	ENSR IRM		
Sample Round				1	1	1	1	1	1	1	1		
Parameter	Units	Maximum Value	Frequency of Detection	NYSDEC TAGM 4046 ⁽²⁾	Number of Exceedances	Number of Detects	Number of Analyses ⁽³⁾	Value (Q)	Value (Q)	Value (Q)	Value (Q)	Value (Q)	Value (Q)
Thallium	MG/KG	1.8	29%	0.7	24	51	178	0.7 J	0.64 J	0.19 U	0.22 U	0.19 U	0.2 U
Vanadium	MG/KG	28.5	100%	150	0	178	178	22.5 J	22.8 J	12.1 J	9.2 J	9.5 J	8.4 J
Zinc	MG/KG	341	100%	110	19	178	178	78.3 J	73.8 J	83.8 J	43.4 J	33.9 J	67.7 J

Note(s):

(1) - Historical sample depths are presented (I.e. prior to 2002 TCRA)

(2) - NYSDEC Technical and Administrative Guidance Memorandum (TAGM) HWR-94-4046, Revised January 24, 1994

(3) - Sample/Duplicate pair are presented as individual samples in this table. Statistical information used Sample Duplicate pairs as a single entity and averaged result values were used in risk assessment analysis.

U = compound was not detected

J = the reported value is an estimated concentration

UJ = the compound was not detected; the associated reporting limit is approximate

R = the data was rejected in the data validating process

NJ = compound was "tentatively identified" and the associated numerical value is approximate

Table A-2A
SURFACE SOIL SAMPLE RESULTS (0-2 ft.)
SEAD-59
SEAD-59 and SEAD-71 Phase II RI Report
Seneca Army Depot Activity

Facility	SEAD-59	SEAD-59	SEAD-59	SEAD-59	SEAD-59	SEAD-59
Location ID	CL-59-03-WS3	CL-59-03-WW1	CL-59-04-F04	CL-59-04-F01	CL-59-04-WE1	CL-59-04-WN1
Maxtrix	SOIL	SOIL	SOIL	SOIL	SOIL	SOIL
Sample ID	CL-59-03-WS3	CL-59-03-WW1	CL-59-04-F04	CL-59-04-F01	CL-59-04-WE1	CL-59-04-WN1
Sample Depth to Top of Sample ⁽¹⁾	0	0	0	0	0	0
Sample Depth to Bottom of Sample ⁽¹⁾	0	0	0	0	0	0
Sample Date	5/6/2004	5/6/2004	5/6/2004	5/6/2004	5/6/2004	5/6/2004
QC Code	SA	SA	SA	SA	SA	SA
Study ID	ENSR IRM	ENSR IRM	ENSR IRM	ENSR IRM	ENSR IRM	ENSR IRM
Sample Round	1	1	1	1	1	1

Parameter	Units	Maximum Value	Frequency of Detection	NYSDEC TAGM 4046 ⁽²⁾	Number of Exceedances	Number of Detects	Number of Analyses ⁽³⁾	Value (Q)	Value (Q)	Value (Q)	Value (Q)	Value (Q)	Value (Q)
Volatile Organics													
1,1,1-Trichloroethane	UG/KG	0	0%	800	0	0	177	5 U	5 U	6 U	5 U	6 UJ	5 U
1,1,2,2-Tetrachloroethane	UG/KG	0	0%	600	0	0	169	5 U	5 U	6 UJ	5 UJ	6 UJ	5 UJ
1,1,2-Trichloro-1,2,2-Trifluoroethane	UG/KG	0	0%		0	0	168	5 U	5 U	6 U	5 UJ	6 UJ	5 UJ
1,1,2-Trichloroethane	UG/KG	0	0%		0	0	107	5 U	5 U	6 U	5 U	6 UJ	5 U
1,1-Dichloroethane	UG/KG	0	0%	200	0	0	177	5 U	5 U	6 U	5 U	6 UJ	5 U
1,1-Dichloroethene	UG/KG	8	2%	400	0	3	177	5 U	5 U	6 U	5 U	6 UJ	5 U
1,2,3-Trichloropropane	UG/KG	0	0%		0	0	70						
1,2,4-Trichlorobenzene	UG/KG	0	0%	3400	0	0	161	5 U	5 U	6 UJ	5 UJ	6 UJ	5 UJ
1,2-Dibromo-3-chloropropane	UG/KG	0	0%		0	0	91	5 U	5 U	6 UJ	5 UJ	6 UJ	5 UJ
1,2-Dibromoethane	UG/KG	0	0%		0	0	98	5 U	5 U	6 U	5 U	6 UJ	5 U
1,2-Dichlorobenzene	UG/KG	0	0%	7900	0	0	161	5 U	5 U	6 UJ	5 UJ	6 UJ	5 UJ
1,2-Dichloroethane	UG/KG	0	0%	100	0	0	177	5 U	5 U	6 U	5 U	6 UJ	5 U
1,2-Dichloroethene (total)	UG/KG	0	0%		0	0	9						
1,2-Dichloropropane	UG/KG	0	0%		0	0	107	5 U	5 U	6 U	5 U	6 UJ	5 U
1,3-Dichlorobenzene	UG/KG	0	0%	1600	0	0	161	5 U	5 U	6 UJ	5 UJ	6 UJ	5 UJ
1,3-Dichloropropane	UG/KG	0	0%		0	0	70						
1,4-Dichlorobenzene	UG/KG	0	0%	8500	0	0	161	5 U	5 U	6 UJ	5 UJ	6 UJ	5 UJ
Acetone	UG/KG	550	27%	200	2	47	177	5 U	5 U	6 U	5 U	6 UJ	5 U
Benzene	UG/KG	3	4%	60	7	7	177	5 U	5 U	1 J	5 U	6 UJ	5 U
Bromodichloromethane	UG/KG	0	0%		0	0	107	5 U	5 U	6 U	5 U	6 UJ	5 U
Bromoform	UG/KG	0	0%		0	0	107	5 U	5 U	6 U	5 U	6 UJ	5 U
Carbon disulfide	UG/KG	4	3%	2700	0	6	177	5 U	5 U	1 J	5 U	6 UJ	5 U
Carbon tetrachloride	UG/KG	0	0%	600	0	0	177	5 U	5 U	6 U	5 U	6 UJ	5 U
Chlorobenzene	UG/KG	0	0%	1700	0	0	177	5 U	5 U	6 U	5 U	6 UJ	5 U
Chlorodibromomethane	UG/KG	0	0%		0	0	177	5 U	5 U	6 U	5 U	6 UJ	5 U
Chloroethane	UG/KG	0	0%	1900	0	0	177	5 U	5 U	6 U	5 U	6 UJ	5 U
Chloroform	UG/KG	0	0%	300	0	0	177	5 U	5 U	6 U	5 U	6 UJ	5 U
Cis-1,2-Dichloroethene	UG/KG	0	0%		0	0	98	5 U	5 U	6 U	5 U	6 UJ	5 U
Cis-1,3-Dichloropropene	UG/KG	0	0%		0	0	107	5 U	5 U	6 U	5 U	6 UJ	5 U
Cyclohexane	UG/KG	3	8%		0	8	98	5 U	5 U	3 J	5 U	2 J	5 U
Dichlorodifluoromethane	UG/KG	0	0%		0	0	98	5 U	5 U	6 U	5 UJ	6 UJ	5 UJ
Ethyl benzene	UG/KG	4.6	1%	5500	0	2	177	5 U	5 U	6 U	5 U	6 UJ	5 U
Isopropylbenzene	UG/KG	0	0%		0	0	98	5 U	5 U	6 U	5 U	6 UJ	5 U
Meta/Para Xylene	UG/KG	9.4	4%		0	3	70						
Methyl Acetate	UG/KG	2	3%		0	3	98	5 U	5 U	6 U	5 U	6 UJ	5 U
Methyl Tertbutyl Ether	UG/KG	0	0%		0	0	98	5 U	5 U	6 U	5 U	6 UJ	5 U
Methyl bromide	UG/KG	0	0%		0	0	107	5 U	5 U	6 U	5 U	6 UJ	5 U
Methyl butyl ketone	UG/KG	0	0%		0	0	107	5 U	5 U	6 U	5 U	6 UJ	5 U
Methyl chloride	UG/KG	0	0%		0	0	107	5 U	5 U	6 U	5 U	6 UJ	5 U
Methyl cyclohexane	UG/KG	5	10%		0	10	98	5 U	5 U	4 J	5 U	3 J	5 U
Methyl ethyl ketone	UG/KG	190	12%	300	0	22	177	5 U	5 U	6 U	5 U	6 UJ	5 U
Methyl isobutyl ketone	UG/KG	1.9	1%	1000	0	1	177	5 U	5 U	6 U	5 U	6 UJ	5 U
Methylene chloride	UG/KG	4.9	20%	100	0	36	178	2 J	1 J	6 U	9 U	6 UJ	6 U
Ortho Xylene	UG/KG	5.05	4%		0	3	70						

Table A-2A
SURFACE SOIL SAMPLE RESULTS (0-2 ft.)
SEAD-59
SEAD-59 and SEAD-71 Phase II RI Report
Seneca Army Depot Activity

Facility	SEAD-59						SEAD-59	SEAD-59	SEAD-59	SEAD-59	SEAD-59	SEAD-59	
Location ID	CL-59-03-WS3						CL-59-03-WW1	CL-59-04-F04	CL-59-04-F01	CL-59-04-WE1	CL-59-04-WN1	CL-59-04-WN1	
Maxtrix	SOIL						SOIL	SOIL	SOIL	SOIL	SOIL	SOIL	
Sample ID	CL-59-03-WS3						CL-59-03-WW1	CL-59-04-F04	CL-59-04-F01	CL-59-04-WE1	CL-59-04-WN1	CL-59-04-WN1	
Sample Depth to Top of Sample ⁽¹⁾	0						0	0	0	0	0	0	
Sample Depth to Bottom of Sample ⁽¹⁾	0						0	0	0	0	0	0	
Sample Date	5/6/2004						5/6/2004	5/6/2004	5/6/2004	5/6/2004	5/6/2004	5/6/2004	
QC Code	SA						SA	SA	SA	SA	SA	SA	
Study ID	ENSR IRM						ENSR IRM	ENSR IRM	ENSR IRM	ENSR IRM	ENSR IRM	ENSR IRM	
Sample Round	1						1	1	1	1	1	1	
Parameter	Units	Maximum Value	Frequency of Detection	NYSDEC TAGM 4046 ⁽²⁾	Number of Exceedances	Number of Detects	Number of Analyses ⁽³⁾	Value (Q)	Value (Q)	Value (Q)	Value (Q)	Value (Q)	Value (Q)
Styrene	UG/KG	0	0%		0	0	107	5 U	5 U	6 U	5 U	6 UJ	5 U
Tetrachloroethene	UG/KG	6.4	3%	1400	0	5	177	5 U	5 U	6 U	5 U	6 UJ	5 U
Toluene	UG/KG	8	8%	1500	0	14	177	5 U	5 U	3 J	1 J	2 J	5 U
Total BTEX	MG/KG	3.25	67%		0	2	3						
Total Xylenes	UG/KG	3	7%	1200	0	7	102	5 U	5 U	2 J	5 UJ	2 J	5 UJ
Trans-1,2-Dichloroethene	UG/KG	0	0%	300	0	0	168	5 U	5 U	6 U	5 U	6 UJ	5 U
Trans-1,3-Dichloropropene	UG/KG	0	0%		0	0	107	5 U	5 U	6 U	5 U	6 UJ	5 U
Trichloroethene	UG/KG	4.5	5%	700	0	8	177	5 U	5 U	6 U	5 U	6 UJ	5 U
Trichlorofluoromethane	UG/KG	6	1%		0	1	98	5 U	5 U	6 U	5 UJ	6 UJ	5 UJ
Vinyl chloride	UG/KG	0	0%	200	0	0	177	5 U	5 U	6 U	5 U	6 UJ	5 U
Semivolatile Organics													
1,1'-Biphenyl	UG/KG	254.5	2%		0	2	99	350 U	400 U	380 U	360 U	390 U	390 U
1,2,4-Trichlorobenzene	UG/KG	0	0%	3400	0	0	9						
1,2-Dichlorobenzene	UG/KG	0	0%	7900	0	0	9						
1,3-Dichlorobenzene	UG/KG	0	0%	1600	0	0	9						
1,4-Dichlorobenzene	UG/KG	0	0%	8500	0	0	9						
2,2'-oxybis(1-Chloropropane)	UG/KG	0	0%		0	0	105	350 U	400 U	380 U	360 U	390 U	390 U
2,4,5-Trichlorophenol	UG/KG	0	0%	100	0	0	178	870 U	1000 U	950 U	910 U	980 U	970 U
2,4,6-Trichlorophenol	UG/KG	0	0%		0	0	178	350 U	400 U	380 U	360 U	390 U	390 U
2,4-Dichlorophenol	UG/KG	0	0%	400	0	0	178	350 U	400 U	380 U	360 U	390 U	390 U
2,4-Dimethylphenol	UG/KG	0	0%		0	0	108	350 U	400 U	380 U	360 U	390 U	390 U
2,4-Dinitrophenol	UG/KG	0	0%	200	0	0	178	870 UJ	1000 UJ	950 UJ	910 UJ	980 UJ	970 UJ
2,4-Dinitrotoluene	UG/KG	0	0%		0	0	178	350 U	400 U	380 U	360 U	390 U	390 U
2,6-Dinitrotoluene	UG/KG	0	0%	1000	0	0	178	350 U	400 U	380 U	360 U	390 U	390 U
2-Chloronaphthalene	UG/KG	0	0%		0	0	108	350 U	400 U	380 U	360 U	390 U	390 U
2-Chlorophenol	UG/KG	0	0%	800	0	0	178	350 U	400 U	380 U	360 U	390 U	390 U
2-Methylnaphthalene	UG/KG	1295	19%	36400	0	34	178	350 U	400 U	380 U	360 U	390 U	390 U
2-Methylphenol	UG/KG	0	0%	100	0	0	178	350 U	400 U	380 U	360 U	390 U	390 U
2-Nitroaniline	UG/KG	0	0%	430	0	0	178	870 U	1000 U	950 U	910 U	980 U	970 U
2-Nitrophenol	UG/KG	0	0%	330	0	0	178	350 U	400 U	380 U	360 U	390 U	390 U
3,3'-Dichlorobenzidine	UG/KG	0	0%		0	0	178	350 U	400 U	380 U	360 U	390 U	390 U
3-Nitroaniline	UG/KG	0	0%	500	0	0	178	870 U	1000 U	950 U	910 U	980 U	970 U
4,6-Dinitro-2-methylphenol	UG/KG	0	0%		0	0	108	870 U	1000 U	950 UJ	910 U	980 UJ	970 U
4-Bromophenyl phenyl ether	UG/KG	0	0%		0	0	108	350 U	400 U	380 U	360 U	390 U	390 U
4-Chloro-3-methylphenol	UG/KG	0	0%	240	0	0	178	350 U	400 U	380 U	360 U	390 U	390 U
4-Chloroaniline	UG/KG	1200	1%	220	1	2	178	350 UJ	400 UJ	380 U	360 UJ	390 U	390 UJ
4-Chlorophenyl phenyl ether	UG/KG	0	0%		0	0	108	350 U	400 U	380 U	360 U	390 U	390 U
4-Methylphenol	UG/KG	150	3%	900	0	5	178	350 U	400 U	380 U	360 U	390 U	390 U
4-Nitroaniline	UG/KG	0	0%		0	0	108	870 UJ	1000 UJ	950 U	910 U	980 U	970 U
4-Nitrophenol	UG/KG	0	0%	100	0	0	178	870 U	1000 U	950 U	910 U	980 U	970 U
Acenaphthene	UG/KG	2680	24%	50000	0	42	178	350 U	400 U	380 U	360 U	390 U	390 U
Acenaphthylene	UG/KG	1700	37%	41000	0	66	178	350 U	400 U	380 U	360 U	390 U	390 U
Acetophenone	UG/KG	0	0%		0	0	99	350 U	400 U	380 U	360 U	390 U	390 U
Aniline	UG/KG	0	0%		0	0	70						
Anthracene	UG/KG	4395	43%	50000	0	77	178	350 U	400 U	380 U	360 U	390 U	390 U

Table A-2A
SURFACE SOIL SAMPLE RESULTS (0-2 ft.)
SEAD-59
SEAD-59 and SEAD-71 Phase II RI Report
Seneca Army Depot Activity

Facility	SEAD-59	SEAD-59	SEAD-59	SEAD-59	SEAD-59	SEAD-59							
Location ID	CL-59-03-WS3	CL-59-03-WW1	CL-59-04-F04	CL-59-04-F01	CL-59-04-WE1	CL-59-04-WN1							
Maxtrix	SOIL	SOIL	SOIL	SOIL	SOIL	SOIL							
Sample ID	CL-59-03-WS3	CL-59-03-WW1	CL-59-04-F04	CL-59-04-F01	CL-59-04-WE1	CL-59-04-WN1							
Sample Depth to Top of Sample ⁽¹⁾	0	0	0	0	0	0							
Sample Depth to Bottom of Sample ⁽¹⁾	0	0	0	0	0	0							
Sample Date	5/6/2004	5/6/2004	5/6/2004	5/6/2004	5/6/2004	5/6/2004							
QC Code	SA	SA	SA	SA	SA	SA							
Study ID	ENSR IRM	ENSR IRM	ENSR IRM	ENSR IRM	ENSR IRM	ENSR IRM							
Sample Round	1	1	1	1	1	1							
Parameter	Units	Maximum Value	Frequency of Detection	NYSDEC TAGM 4046 ⁽²⁾	Number of Exceedances	Number of Detects	Number of Analyses ⁽³⁾	Value (Q)	Value (Q)	Value (Q)	Value (Q)	Value (Q)	Value (Q)
Atrazine	UG/KG	120	1%		0	1	99	350 U	400 U	380 U	360 U	390 U	390 U
Benzaldehyde	UG/KG	50	1%		0	1	99	350 UJ	400 UJ	380 U	360 U	390 U	390 U
Benzo(a)anthracene	UG/KG	8900	51%	224	72	90	178	350 U	400 U	380 U	360 U	390 U	390 U
Benzo(a)pyrene	UG/KG	8050	51%	61	84	91	178	350 U	400 U	380 U	360 U	390 U	390 U
Benzo(b)fluoranthene	UG/KG	6800	52%	1100	40	92	178	350 U	400 U	380 U	360 U	390 U	390 U
Benzo(ghi)perylene	UG/KG	5200	46%	50000	0	82	178	350 U	400 U	380 U	360 U	390 U	390 U
Benzo(k)fluoranthene	UG/KG	7350	49%	1100	35	88	178	350 U	400 U	380 U	360 U	390 U	390 U
Benzoic Acid	UG/KG	0	0%	2700	0	0	70						
Bis(2-Chloroethoxy)methane	UG/KG	0	0%		0	0	108	350 U	400 U	380 U	360 U	390 U	390 U
Bis(2-Chloroethyl)ether	UG/KG	0	0%		0	0	108	350 U	400 U	380 U	360 U	390 U	390 U
Bis(2-Chloroisopropyl)ether	UG/KG	0	0%		0	0	3						
Bis(2-Ethylhexyl)phthalate	UG/KG	990	19%	50000	0	34	178	350 U	400 U	50 NJ	360 U	48 NJ	390 U
Butylbenzylphthalate	UG/KG	0	0%	50000	0	0	178	350 U	400 U	380 U	360 U	390 U	390 U
Caprolactam	UG/KG	0	0%		0	0	99	350 U	400 U	380 U	360 U	390 U	390 U
Carbazole	UG/KG	755	19%		0	20	108	350 U	400 U	380 U	360 U	390 U	390 U
Chrysene	UG/KG	8900	51%	400	62	91	178	350 U	400 U	380 U	360 U	390 U	390 U
Di-n-butylphthalate	UG/KG	965	2%	8100	0	4	178	350 U	400 U	380 U	360 U	390 U	390 U
Di-n-octylphthalate	UG/KG	0	0%	50000	0	0	178	350 U	400 U	380 U	360 U	390 U	390 U
Dibenz(a,h)anthracene	UG/KG	1665	38%	14	67	68	178	350 U	400 U	380 U	360 U	390 U	390 U
Dibenzofuran	UG/KG	2350	16%	6200	0	28	178	350 U	400 U	380 U	360 U	390 U	390 U
Diethyl phthalate	UG/KG	10	1%	7100	0	1	178	350 U	400 U	380 U	360 U	390 U	390 U
Dimethylphthalate	UG/KG	0	0%	2000	0	0	178	350 U	400 U	380 U	360 U	390 U	390 U
Fluoranthene	UG/KG	23500	54%	50000	0	97	178	350 U	400 U	380 U	37 J	390 U	390 U
Fluorene	UG/KG	2640	28%	50000	0	49	178	350 U	400 U	380 U	360 U	390 U	390 U
Hexachlorobenzene	UG/KG	0	0%	410	0	0	178	350 U	400 U	380 U	360 U	390 U	390 U
Hexachlorobutadiene	UG/KG	0	0%		0	0	178	350 U	400 U	380 U	360 U	390 U	390 U
Hexachlorocyclopentadiene	UG/KG	0	0%		0	0	108	350 U	400 U	380 U	360 U	390 U	390 U
Hexachloroethane	UG/KG	0	0%		0	0	178	350 U	400 U	380 U	360 U	390 U	390 U
Indeno(1,2,3-cd)pyrene	UG/KG	4950	47%	3200	2	84	178	350 U	400 U	380 U	360 U	390 U	390 U
Isophorone	UG/KG	0	0%	4400	0	0	178	350 U	400 U	380 U	360 U	390 U	390 U
N-Nitrosodiphenylamine	UG/KG	100	1%		0	1	108	350 U	400 U	380 U	360 U	390 U	390 U
N-Nitrosodipropylamine	UG/KG	0	0%		0	0	108	350 U	400 U	380 UJ	360 U	390 UJ	390 U
Naphthalene	UG/KG	1800	19%	13000	0	34	178	350 U	400 U	380 U	360 U	390 U	390 U
Nitrobenzene	UG/KG	0	0%	200	0	0	178	350 U	400 U	380 U	360 U	390 U	390 U
Pentachlorophenol	UG/KG	0	0%	1000	0	0	178	870 U	1000 U	950 U	910 U	980 U	970 U
Phenanthrene	UG/KG	21300	51%	50000	0	90	178	350 U	400 U	380 U	360 U	390 U	390 U
Phenol	UG/KG	0	0%	30	0	0	178	350 U	400 U	380 U	360 U	390 U	390 U
Pyrene	UG/KG	19200	55%	50000	0	98	178	350 U	400 U	380 U	43 J	390 U	390 U
Pyridine	UG/KG	0	0%		0	0	100						
Total Unknown PAHs as SV	MG/KG	25	100%		0	3	3						
Pesticides/PCBs													
4,4'-DDD	UG/KG	740	28%	2900	0	49	178	3.5 U	4 U	3.8 U	3.6 U	3.9 U	3.9 U
4,4'-DDE	UG/KG	2600	37%	2100	1	65	178	3.5 U	4 U	3.8 U	3.6 U	3.9 U	3.9 U
4,4'-DDT	UG/KG	3700	33%	2100	1	59	178	3.5 U	5.8	3.8 U	3.6 U	3.9 U	3.9 U
Aldrin	UG/KG	1.2	1%	41	0	1	178	1.8 U	2.1 U	2 U	1.9 U	2 U	2 U

Table A-2A
SURFACE SOIL SAMPLE RESULTS (0-2 ft.)
SEAD-59
SEAD-59 and SEAD-71 Phase II RI Report
Seneca Army Depot Activity

Facility	SEAD-59	SEAD-59	SEAD-59	SEAD-59	SEAD-59	SEAD-59							
Location ID	CL-59-03-WS3	CL-59-03-WW1	CL-59-04-F04	CL-59-04-F01	CL-59-04-WE1	CL-59-04-WN1							
Maxtrix	SOIL	SOIL	SOIL	SOIL	SOIL	SOIL							
Sample ID	CL-59-03-WS3	CL-59-03-WW1	CL-59-04-F04	CL-59-04-F01	CL-59-04-WE1	CL-59-04-WN1							
Sample Depth to Top of Sample ⁽¹⁾	0	0	0	0	0	0							
Sample Depth to Bottom of Sample ⁽¹⁾	0	0	0	0	0	0							
Sample Date	5/6/2004	5/6/2004	5/6/2004	5/6/2004	5/6/2004	5/6/2004							
QC Code	SA	SA	SA	SA	SA	SA							
Study ID	ENSR IRM	ENSR IRM	ENSR IRM	ENSR IRM	ENSR IRM	ENSR IRM							
Sample Round	1	1	1	1	1	1							
Parameter	Units	Maximum Value	Frequency of Detection	NYSDEC TAGM 4046 ⁽²⁾	Number of Exceedances	Number of Detects	Number of Analyses ⁽³⁾	Value (Q)	Value (Q)	Value (Q)	Value (Q)	Value (Q)	Value (Q)
Alpha-BHC	UG/KG	0	0%	110	0	0	178	1.8 U	2.1 U	2 U	1.9 UJ	2 U	2 UJ
Alpha-Chlordane	UG/KG	34	4%		0	7	178	1.8 U	2.1 U	2 U	1.9 U	2 U	2 U
Beta-BHC	UG/KG	2.4	1%	200	0	1	178	1.8 U	2.1 U	2 U	1.9 U	2 U	2 U
Delta-BHC	UG/KG	0	0%	300	0	0	178	1.8 U	2.1 U	2 U	1.9 U	2 U	2 U
Dieldrin	UG/KG	0	0%	44	0	0	178	3.5 U	4 U	3.8 U	3.6 U	3.9 U	3.9 U
Endosulfan I	UG/KG	16	1%	900	0	1	178	1.8 U	2.1 U	2 U	1.9 U	2 U	2 U
Endosulfan II	UG/KG	0	0%	900	0	0	178	3.5 U	4 U	3.8 U	3.6 U	3.9 U	3.9 U
Endosulfan sulfate	UG/KG	6.2	1%	1000	0	1	178	3.5 U	4 U	3.8 U	3.6 U	3.9 U	3.9 U
Endrin	UG/KG	16	2%	100	0	3	178	3.5 U	4 U	3.8 U	16 NJ	3.9 U	3.9 U
Endrin aldehyde	UG/KG	4.9	1%		0	2	178	3.5 U	4 U	3.8 U	3.6 U	3.9 U	3.9 U
Endrin ketone	UG/KG	38	2%		0	4	178	3.5 U	4 U	3.8 U	3.6 U	3.9 U	3.9 U
Gamma-BHC/Lindane	UG/KG	0	0%	60	0	0	178	1.8 U	2.1 U	2 U	1.9 U	2 U	2 U
Gamma-Chlordane	UG/KG	24	8%	540	0	14	178	1.8 U	2.1 U	2 U	1.9 U	2 U	2 U
Heptachlor	UG/KG	0	0%	100	0	0	178	1.8 U	2.1 U	2 U	1.9 U	2 U	2 U
Heptachlor epoxide	UG/KG	3	1%	20	0	2	178	1.8 U	2.1 U	2 U	1.9 U	2 U	2 U
Methoxychlor	UG/KG	0	0%		0	0	178	18 U	21 U	20 U	19 U	20 U	20 U
Toxaphene	UG/KG	0	0%		0	0	178	180 UJ	210 UJ	200 U	190 U	200 U	200 U
Aroclor-1016	UG/KG	0	0%		0	0	178	35 U	41 U	39 U	37 U	40 U	39 U
Aroclor-1221	UG/KG	0	0%		0	0	178	35 U	41 U	39 U	37 U	40 U	39 U
Aroclor-1232	UG/KG	0	0%		0	0	178	35 U	41 U	39 U	37 U	40 U	39 U
Aroclor-1242	UG/KG	0	0%		0	0	178	35 U	41 U	39 U	37 U	40 U	39 U
Aroclor-1248	UG/KG	0	0%		0	0	178	35 U	41 U	39 U	37 U	40 U	39 U
Aroclor-1254	UG/KG	0	0%	10000	0	0	178	35 U	41 U	39 U	37 U	40 U	39 U
Aroclor-1260	UG/KG	79	1%	10000	0	2	178	35 U	41 U	39 U	37 U	40 U	39 U
Metals													
Aluminum	MG/KG	18300	100%	19300	0	178	178	15800 J	12500 J	4870	12000 J	9390	7880 J
Antimony	MG/KG	424	58%		5	104	178	0.14 UJ	1.4 J	0.7 J	1.9 J	1.3 J	1.1 J
Arsenic	MG/KG	32.2	100%	8.2	7	178	178	3.6 J	5.3 J	3.5	8 J	3.2	4.6 J
Barium	MG/KG	304	100%	300	1	178	178	52.9 J	169 J	26.2	78.6 J	78.2	66.6 J
Beryllium	MG/KG	2.6	99%	1.1	2	176	178	0.09 U	0.67	0.26	0.57	0.42	0.39
Cadmium	MG/KG	3.2	86%	2.3	2	153	178	0.24 J	0.23 J	0.15 J	0.29 J	0.22	0.22 J
Calcium	MG/KG	214000	100%	121000	1	178	178	15000 J	11900 J	64000	2940 J	78000	38700 J
Chromium	MG/KG	39.3	100%	29.6	2	178	178	20.2 J	19.8 J	8.2	20 J	13.1	11.5 J
Cobalt	MG/KG	47.8	100%	30	2	178	178	18.6 J	7.3 J	5.4 J	14.8 J	5.9 J	7.5 J
Copper	MG/KG	305	100%	33	178	178	178	10 J	19.6 J	19.5	23.6 J	20.1	18.1 J
Cyanide	MG/KG	0	0%	0.35	0	0	9						
Iron	MG/KG	64000	100%	36500	1	178	178	18500 J	23200 J	13800 J	29600 J	17800 J	14700 J
Lead	MG/KG	164	100%	24.8	75	178	178	7.1 J	13.9 J	5.6 J	9.3 J	7.1 J	8.5 J
Magnesium	MG/KG	30200	100%	21500	3	178	178	25300 J	5360 J	14700 J	5320 J	18700 J	9600 J
Manganese	MG/KG	1290	100%	1060	3	178	178	296 J	185 J	286 J	782 J	322 J	399 J
Mercury	MG/KG	0.95	95%	0.1	37	169	178	0.02 J	0.24 J	0.02 U	0.02 J	0.02 U	0.04 J
Nickel	MG/KG	88.3	100%	49	3	178	178	29.8 J	27.8 J	13.7 J	36.1 J	17.4 J	21.2 J
Potassium	MG/KG	2290	100%	2380	0	178	178	972 J	857 J	654	736 J	1830	787 J
Selenium	MG/KG	1.5	9%	2	0	16	178	0.36 U	0.43 U	0.42 U	0.42 U	0.4 U	0.43 U
Silver	MG/KG	2.9	49%	0.75	62	87	178	1.3 J	2.1 J	0.11 U	1.6 J	0.1 U	0.61 J
Sodium	MG/KG	4060	99%	172	86	177	178	3410 J	2070 J	137	82 J	190	73.6 J

**Table A-2A
SURFACE SOIL SAMPLE RESULTS (0-2 ft.)
SEAD-59
SEAD-59 and SEAD-71 Phase II RI Report
Seneca Army Depot Activity**

				SEAD-59	SEAD-59	SEAD-59	SEAD-59	SEAD-59	SEAD-59	SEAD-59			
				CL-59-03-WS3	CL-59-03-WW1	CL-59-04-F04	CL-59-04-F01	CL-59-04-WE1	CL-59-04-WN1	CL-59-04-WN1			
				SOIL	SOIL	SOIL	SOIL	SOIL	SOIL	SOIL			
				CL-59-03-WS3	CL-59-03-WW1	CL-59-04-F04	CL-59-04-F01	CL-59-04-WE1	CL-59-04-WN1	CL-59-04-WN1			
Sample Depth to Top of Sample ⁽¹⁾				0	0	0	0	0	0	0			
Sample Depth to Bottom of Sample ⁽¹⁾				0	0	0	0	0	0	0			
Sample Date				5/6/2004	5/6/2004	5/6/2004	5/6/2004	5/6/2004	5/6/2004	5/6/2004			
QC Code				SA	SA	SA	SA	SA	SA	SA			
Study ID				ENSR IRM	ENSR IRM	ENSR IRM	ENSR IRM	ENSR IRM	ENSR IRM	ENSR IRM			
Sample Round				1	1	1	1	1	1	1			
Parameter	Units	Maximum Value	Frequency of Detection	NYSDEC TAGM 4046 ⁽²⁾	Number of Exceedances	Number of Detects	Number of Analyses ⁽³⁾	Value (Q)	Value (Q)	Value (Q)	Value (Q)	Value (Q)	Value (Q)
Thallium	MG/KG	1.8	29%	0.7	24	51	178	1.8 J	0.55 J	0.21 U	0.21 U	0.2 U	0.21 U
Vanadium	MG/KG	28.5	100%	150	0	178	178	28.5 J	20.1 J	9.5	16.1 J	17.2	13.5 J
Zinc	MG/KG	341	100%	110	19	178	178	25.3 J	64.1 J	34.6 J	75.2 J	36.8 J	40.3 J

Note(s):

(1) - Historical sample depths are presented (I.e. prior to 2002 TCRA)

(2) - NYSDEC Technical and Administrative Guidance Memorandum (TAGM) HWR-94-4046, Revised January 24, 1994

(3) - Sample/Duplicate pair are presented as individual samples in this table. Statistical information used Sample Duplicate pairs as a single entity and averaged result values were used in risk assessment analysis.

U = compound was not detected

J = the reported value is an estimated concentration

UJ = the compound was not detected; the associated reporting limit is approximate

R = the data was rejected in the data validating process

NJ = compound was "tentatively identified" and the associated numerical value is approximate

**Table A-2A
SURFACE SOIL SAMPLE RESULTS (0-2 ft.)
SEAD-59
SEAD-59 and SEAD-71 Phase II RI Report
Seneca Army Depot Activity**

Facility	SEAD-59	SEAD-59	SEAD-59	SEAD-59	SEAD-59							
Location ID	CL-59-04-WN2	CL-59-04-WS1	CL-59-04-WS2	CL-59-04-WW1	CL-59-OTHERA-F01							
Maxtrix	SOIL	SOIL	SOIL	SOIL	SOIL							
Sample ID	CL-59-04-WN2	CL-59-04-WS1	CL-59-04-WS2	CL-59-04-WW1	CL-59-OTHERA-F01							
Sample Depth to Top of Sample ⁽¹⁾	0	0	0	0	0							
Sample Depth to Bottom of Sample ⁽¹⁾	0	0	0	0	0							
Sample Date	5/6/2004	5/6/2004	5/6/2004	5/6/2004	5/6/2004							
QC Code	SA	SA	SA	SA	SA							
Study ID	ENSR IRM	ENSR IRM	ENSR IRM	ENSR IRM	ENSR IRM							
Sample Round	1	1	1	1	1							
Parameter	Units	Maximum Value	Frequency of Detection	NYSDEC TAGM 4046 ⁽²⁾	Number of Exceedances	Number of Detects	Number of Analyses ⁽³⁾	Value (Q)	Value (Q)	Value (Q)	Value (Q)	Value (Q)
Volatile Organics												
1,1,1-Trichloroethane	UG/KG	0	0%	800	0	0	177	4 U	5.5 U	6 U	5 U	5 U
1,1,2,2-Tetrachloroethane	UG/KG	0	0%	600	0	0	169	4 UJ	5.5 U	6 U	5 U	5 UJ
1,1,2-Trichloro-1,2,2-Trifluoroethane	UG/KG	0	0%		0	0	168	4 UJ	5.5 U	6 U	5 U	5 U
1,1,2-Trichloroethane	UG/KG	0	0%		0	0	107	4 U		6 U	5 U	5 U
1,1-Dichloroethane	UG/KG	0	0%	200	0	0	177	4 U	5.5 U	6 U	5 U	5 U
1,1-Dichloroethene	UG/KG	8	2%	400	0	3	177	4 U	5.5 U	6 U	5 U	5 U
1,2,3-Trichloropropane	UG/KG	0	0%		0	0	70		5.5 U			
1,2,4-Trichlorobenzene	UG/KG	0	0%	3400	0	0	161	4 UJ	5.5 U	6 U	5 U	5 UJ
1,2-Dibromo-3-chloropropane	UG/KG	0	0%		0	0	91	4 UJ		6 U	5 U	5 UJ
1,2-Dibromoethane	UG/KG	0	0%		0	0	98	4 U		6 U	5 U	5 U
1,2-Dichlorobenzene	UG/KG	0	0%	7900	0	0	161	4 UJ	5.5 U	6 U	5 U	5 UJ
1,2-Dichloroethane	UG/KG	0	0%	100	0	0	177	4 U	5.5 U	6 U	5 U	5 U
1,2-Dichloroethene (total)	UG/KG	0	0%		0	0	9					
1,2-Dichloropropane	UG/KG	0	0%		0	0	107	4 U		6 U	5 U	5 U
1,3-Dichlorobenzene	UG/KG	0	0%	1600	0	0	161	4 UJ	5.5 U	6 U	5 U	5 UJ
1,3-Dichloropropane	UG/KG	0	0%		0	0	70		5.5 U			
1,4-Dichlorobenzene	UG/KG	0	0%	8500	0	0	161	4 UJ	5.5 U	6 U	5 U	5 UJ
Acetone	UG/KG	550	27%	200	2	47	177	4 U	22 U	11 NJ	14 NJ	5 UJ
Benzene	UG/KG	3	4%	60	0	7	177	4 U	5.5 U	6 U	5 U	1 J
Bromodichloromethane	UG/KG	0	0%		0	0	107	4 U		6 U	5 U	5 U
Bromoform	UG/KG	0	0%		0	0	107	4 U		6 U	5 U	5 U
Carbon disulfide	UG/KG	4	3%	2700	0	6	177	4 U	5.5 U	1 J	5 U	5 U
Carbon tetrachloride	UG/KG	0	0%	600	0	0	177	4 U	5.5 U	6 U	5 U	5 U
Chlorobenzene	UG/KG	0	0%	1700	0	0	177	4 U	5.5 U	6 U	5 U	5 U
Chlorodibromomethane	UG/KG	0	0%		0	0	177	4 U	5.5 U	6 U	5 U	5 U
Chloroethane	UG/KG	0	0%	1900	0	0	177	4 U	11 U	6 U	5 U	5 UJ
Chloroform	UG/KG	0	0%	300	0	0	177	4 U	5.5 U	6 U	5 U	5 U
Cis-1,2-Dichloroethene	UG/KG	0	0%		0	0	98	4 U		6 U	5 U	5 U
Cis-1,3-Dichloropropene	UG/KG	0	0%		0	0	107	4 U		6 U	5 U	5 U
Cyclohexane	UG/KG	3	8%		0	8	98	4 U		6 U	5 U	3 J
Dichlorodifluoromethane	UG/KG	0	0%		0	0	98	4 UJ		6 U	5 U	5 U
Ethyl benzene	UG/KG	4.6	1%	5500	0	2	177	4 U	5.5 U	6 U	5 U	5 U
Isopropylbenzene	UG/KG	0	0%		0	0	98	4 U		6 U	5 U	5 U
Meta/Para Xylene	UG/KG	9.4	4%		0	3	70		5.5 U			
Methyl Acetate	UG/KG	2	3%		0	3	98	4 U		6 U	5 U	5 U
Methyl Tertbutyl Ether	UG/KG	0	0%		0	0	98	4 U		6 U	5 U	5 U
Methyl bromide	UG/KG	0	0%		0	0	107	4 U		6 U	5 U	5 U
Methyl butyl ketone	UG/KG	0	0%		0	0	107	4 U		6 U	5 U	5 U
Methyl chloride	UG/KG	0	0%		0	0	107	4 U		6 U	5 U	5 U
Methyl cyclohexane	UG/KG	5	10%		0	10	98	4 U		1 J	5 U	4 J
Methyl ethyl ketone	UG/KG	190	12%	300	0	22	177	4 U	11 U	6 U	5 U	5 U
Methyl isobutyl ketone	UG/KG	1.9	1%	1000	0	1	177	4 U	11 U	6 U	5 U	5 U
Methylene chloride	UG/KG	4.9	20%	100	0	36	178	7 U	5.5 U	6 U	5 U	5 U
Ortho Xylene	UG/KG	5.05	4%		0	3	70		5.5 U			

Table A-2A
SURFACE SOIL SAMPLE RESULTS (0-2 ft.)
SEAD-59
SEAD-59 and SEAD-71 Phase II RI Report
Seneca Army Depot Activity

Facility	SEAD-59	SEAD-59	SEAD-59	SEAD-59	SEAD-59							
Location ID	CL-59-04-WN2	CL-59-04-WS1	CL-59-04-WS2	CL-59-04-WW1	CL-59-OTHERA-F01							
Maxtrix	SOIL	SOIL	SOIL	SOIL	SOIL							
Sample ID	CL-59-04-WN2	CL-59-04-WS1	CL-59-04-WS2	CL-59-04-WW1	CL-59-OTHERA-F01							
Sample Depth to Top of Sample ⁽¹⁾	0	0	0	0	0							
Sample Depth to Bottom of Sample ⁽¹⁾	0	0	0	0	0							
Sample Date	5/6/2004	5/6/2004	5/6/2004	5/6/2004	5/6/2004							
QC Code	SA	SA	SA	SA	SA							
Study ID	ENSR IRM	ENSR IRM	ENSR IRM	ENSR IRM	ENSR IRM							
Sample Round	1	1	1	1	1							
Parameter	Units	Maximum Value	Frequency of Detection	NYSDEC TAGM 4046 ⁽²⁾	Number of Exceedances	Number of Detects	Number of Analyses ⁽³⁾	Value (Q)	Value (Q)	Value (Q)	Value (Q)	Value (Q)
Styrene	UG/KG	0	0%		0	0	107	4 U		6 U	5 U	5 U
Tetrachloroethene	UG/KG	6.4	3%	1400	0	5	177	4 U	5.5 U	6 U	5 U	5 U
Toluene	UG/KG	8	8%	1500	0	14	177	0.9 J	5.5 U	6 U	5 U	2 J
Total BTEX	MG/KG	3.25	67%		0	2	3					
Total Xylenes	UG/KG	3	7%	1200	0	7	102	4 UJ		6 U	5 U	5 UJ
Trans-1,2-Dichloroethene	UG/KG	0	0%	300	0	0	168	4 U	5.5 U	6 U	5 U	5 U
Trans-1,3-Dichloropropene	UG/KG	0	0%		0	0	107	4 U		6 U	5 U	5 U
Trichloroethene	UG/KG	4.5	5%	700	0	8	177	4 U	5.5 U	6 U	5 U	5 U
Trichlorofluoromethane	UG/KG	6	1%		0	1	98	4 UJ		6 U	5 U	5 U
Vinyl chloride	UG/KG	0	0%	200	0	0	177	4 U	11 U	6 U	5 U	5 U
Semivolatile Organics												
1,1'-Biphenyl	UG/KG	254.5	2%		0	2	99	360 U		370 U	370 U	350 U
1,2,4-Trichlorobenzene	UG/KG	0	0%	3400	0	0	9					
1,2-Dichlorobenzene	UG/KG	0	0%	7900	0	0	9					
1,3-Dichlorobenzene	UG/KG	0	0%	1600	0	0	9					
1,4-Dichlorobenzene	UG/KG	0	0%	8500	0	0	9					
2,2'-oxybis(1-Chloropropane)	UG/KG	0	0%		0	0	105	360 U		370 U	370 U	350 U
2,4,5-Trichlorophenol	UG/KG	0	0%	100	0	0	178	900 U	370 U	940 U	940 U	880 U
2,4,6-Trichlorophenol	UG/KG	0	0%		0	0	178	360 U	370 U	370 U	370 U	350 U
2,4-Dichlorophenol	UG/KG	0	0%	400	0	0	178	360 U	370 U	370 U	370 U	350 U
2,4-Dimethylphenol	UG/KG	0	0%		0	0	108	360 U		370 U	370 U	350 U
2,4-Dinitrophenol	UG/KG	0	0%	200	0	0	178	900 UJ	1900 U	940 UJ	940 UJ	880 U
2,4-Dinitrotoluene	UG/KG	0	0%		0	0	178	360 U	370 U	370 U	370 U	350 U
2,6-Dinitrotoluene	UG/KG	0	0%	1000	0	0	178	360 U	370 U	370 U	370 U	350 U
2-Chloronaphthalene	UG/KG	0	0%		0	0	108	360 U		370 U	370 U	350 U
2-Chlorophenol	UG/KG	0	0%	800	0	0	178	360 U	370 U	370 U	370 U	350 U
2-Methylnaphthalene	UG/KG	1295	19%	36400	0	34	178	360 U	370 U	370 U	370 U	350 U
2-Methylphenol	UG/KG	0	0%	100	0	0	178	360 U	370 U	370 U	370 U	350 U
2-Nitroaniline	UG/KG	0	0%	430	0	0	178	900 U	1900 U	940 U	940 U	880 U
2-Nitrophenol	UG/KG	0	0%	330	0	0	178	360 U	370 U	370 U	370 U	350 U
3,3'-Dichlorobenzidine	UG/KG	0	0%		0	0	178	360 U	370 U	370 U	370 U	350 U
3-Nitroaniline	UG/KG	0	0%	500	0	0	178	900 U	1900 U	940 U	940 U	880 U
4,6-Dinitro-2-methylphenol	UG/KG	0	0%		0	0	108	900 U		940 UJ	940 UJ	880 U
4-Bromophenyl phenyl ether	UG/KG	0	0%		0	0	108	360 U		370 U	370 U	350 U
4-Chloro-3-methylphenol	UG/KG	0	0%	240	0	0	178	360 U	370 U	370 U	370 U	350 U
4-Chloroaniline	UG/KG	1200	1%	220	1	2	178	360 UJ	370 U	370 U	370 U	350 U
4-Chlorophenyl phenyl ether	UG/KG	0	0%		0	0	108	360 U		370 U	370 U	350 U
4-Methylphenol	UG/KG	150	3%	900	0	5	178	360 U	370 U	370 U	370 U	350 U
4-Nitroaniline	UG/KG	0	0%		0	0	108	900 U		940 U	940 U	880 U
4-Nitrophenol	UG/KG	0	0%	100	0	0	178	900 U	1900 U	940 U	940 U	880 U
Acenaphthene	UG/KG	2680	24%	50000	0	42	178	360 U	370 U	370 U	370 U	350 U
Acenaphthylene	UG/KG	1700	37%	41000	0	66	178	360 U	370 U	370 U	370 U	350 U
Acetophenone	UG/KG	0	0%		0	0	99	360 U		370 U	370 U	350 U
Aniline	UG/KG	0	0%		0	0	70		370 U			
Anthracene	UG/KG	4395	43%	50000	0	77	178	360 U	370 U	370 U	370 U	350 U

**Table A-2A
SURFACE SOIL SAMPLE RESULTS (0-2 ft.)
SEAD-59
SEAD-59 and SEAD-71 Phase II RI Report
Seneca Army Depot Activity**

Facility	SEAD-59	SEAD-59	SEAD-59	SEAD-59	SEAD-59							
Location ID	CL-59-04-WN2	CL-59-04-WS1	CL-59-04-WS2	CL-59-04-WW1	CL-59-OTHERA-F01							
Maxtrix	SOIL	SOIL	SOIL	SOIL	SOIL							
Sample ID	CL-59-04-WN2	CL-59-04-WS1	CL-59-04-WS2	CL-59-04-WW1	CL-59-OTHERA-F01							
Sample Depth to Top of Sample ⁽¹⁾	0	0	0	0	0							
Sample Depth to Bottom of Sample ⁽¹⁾	0	0	0	0	0							
Sample Date	5/6/2004	5/6/2004	5/6/2004	5/6/2004	5/6/2004							
QC Code	SA	SA	SA	SA	SA							
Study ID	ENSR IRM	ENSR IRM	ENSR IRM	ENSR IRM	ENSR IRM							
Sample Round	1	1	1	1	1							
Parameter	Units	Maximum Value	Frequency of Detection	NYSDEC TAGM 4046 ⁽²⁾	Number of Exceedances	Number of Detects	Number of Analyses ⁽³⁾	Value (Q)	Value (Q)	Value (Q)	Value (Q)	Value (Q)
Atrazine	UG/KG	120	1%		0	1	99	360 U		370 U	370 U	350 U
Benzaldehyde	UG/KG	50	1%		0	1	99	360 U		370 U	370 U	350 U
Benzo(a)anthracene	UG/KG	8900	51%	224	72	90	178	360 U	370 U	370 U	370 U	350 U
Benzo(a)pyrene	UG/KG	8050	51%	61	84	91	178	360 U	370 U	370 U	370 U	350 U
Benzo(b)fluoranthene	UG/KG	6800	52%	1100	40	92	178	360 U	370 U	370 U	370 U	350 U
Benzo(ghi)perylene	UG/KG	5200	46%	50000	0	82	178	360 U	370 U	370 U	370 U	350 U
Benzo(k)fluoranthene	UG/KG	7350	49%	1100	35	88	178	360 U	370 U	370 U	370 U	350 U
Benzoic Acid	UG/KG	0	0%	2700	0	0	70		1900 U			
Bis(2-Chloroethoxy)methane	UG/KG	0	0%		0	0	108	360 U		370 U	370 U	350 U
Bis(2-Chloroethyl)ether	UG/KG	0	0%		0	0	108	360 U		370 U	370 U	350 U
Bis(2-Chloroisopropyl)ether	UG/KG	0	0%		0	0	3					
Bis(2-Ethylhexyl)phthalate	UG/KG	990	19%	50000	0	34	178	360 U	370 U	44 NJ	47 NJ	350 U
Butylbenzylphthalate	UG/KG	0	0%	50000	0	0	178	360 U	370 U	370 U	370 U	350 U
Caprolactam	UG/KG	0	0%		0	0	99	360 U		370 U	370 U	350 U
Carbazole	UG/KG	755	19%		0	20	108	360 U		370 U	370 U	350 U
Chrysene	UG/KG	8900	51%	400	62	91	178	360 U	370 U	370 U	370 U	350 U
Di-n-butylphthalate	UG/KG	965	2%	8100	0	4	178	360 U	370 U	370 U	370 U	350 U
Di-n-octylphthalate	UG/KG	0	0%	50000	0	0	178	360 U	370 U	370 U	370 U	350 U
Dibenz(a,h)anthracene	UG/KG	1665	38%	14	67	68	178	360 U	370 U	370 U	370 U	350 U
Dibenzofuran	UG/KG	2350	16%	6200	0	28	178	360 U	370 U	370 U	370 U	350 U
Diethyl phthalate	UG/KG	10	1%	7100	0	1	178	360 U	370 U	370 U	370 U	350 U
Dimethylphthalate	UG/KG	0	0%	2000	0	0	178	360 U	370 U	370 U	370 U	350 U
Fluoranthene	UG/KG	23500	54%	50000	0	97	178	360 U	370 U	370 U	370 U	350 U
Fluorene	UG/KG	2640	28%	50000	0	49	178	360 U	370 U	370 U	370 U	350 U
Hexachlorobenzene	UG/KG	0	0%	410	0	0	178	360 U	370 U	370 U	370 U	350 U
Hexachlorobutadiene	UG/KG	0	0%		0	0	178	360 U	370 U	370 U	370 U	350 U
Hexachlorocyclopentadiene	UG/KG	0	0%		0	0	108	360 U		370 U	370 U	350 U
Hexachloroethane	UG/KG	0	0%		0	0	178	360 U	370 U	370 U	370 U	350 U
Indeno(1,2,3-cd)pyrene	UG/KG	4950	47%	3200	2	84	178	360 U	370 U	370 U	370 U	350 U
Isophorone	UG/KG	0	0%	4400	0	0	178	360 U	370 U	370 U	370 U	350 U
N-Nitrosodiphenylamine	UG/KG	100	1%		0	1	108	360 U		370 U	370 U	350 U
N-Nitrosodipropylamine	UG/KG	0	0%		0	0	108	360 U		370 UJ	370 UJ	350 U
Naphthalene	UG/KG	1800	19%	13000	0	34	178	360 U	370 U	370 U	370 U	350 U
Nitrobenzene	UG/KG	0	0%	200	0	0	178	360 U	370 U	370 U	370 U	350 U
Pentachlorophenol	UG/KG	0	0%	1000	0	0	178	900 U	1900 U	940 U	940 U	880 U
Phenanthrene	UG/KG	21300	51%	50000	0	90	178	360 U	370 U	370 U	370 U	350 U
Phenol	UG/KG	0	0%	30	0	0	178	360 U	370 U	370 U	370 U	350 U
Pyrene	UG/KG	19200	55%	50000	0	98	178	360 U	370 U	370 U	370 U	350 U
Pyridine	UG/KG	0	0%		0	0	100		1900 U			
Total Unknown PAHs as SV	MG/KG	25	100%		0	3	3					
Pesticides/PCBs												
4,4'-DDD	UG/KG	740	28%	2900	0	49	178	3.6 U	18 U	3.7 U	3.7 U	3.5 U
4,4'-DDE	UG/KG	2600	37%	2100	1	65	178	3.6 U	18 U	3.7 U	3.7 U	3.5 U
4,4'-DDT	UG/KG	3700	33%	2100	1	59	178	3.6 U	18 U	3.7 U	3.7 U	4.9
Aldrin	UG/KG	1.2	1%	41	0	1	178	1.8 U	9.4 U	1.9 U	1.9 U	1.8 U

Table A-2A
SURFACE SOIL SAMPLE RESULTS (0-2 ft.)
SEAD-59
SEAD-59 and SEAD-71 Phase II RI Report
Seneca Army Depot Activity

Facility								SEAD-59	SEAD-59	SEAD-59	SEAD-59	SEAD-59
Location ID								CL-59-04-WN2	CL-59-04-WS1	CL-59-04-WS2	CL-59-04-WW1	CL-59-OTHERA-F01
Maxtrix								SOIL	SOIL	SOIL	SOIL	SOIL
Sample ID								CL-59-04-WN2	CL-59-04-WS1	CL-59-04-WS2	CL-59-04-WW1	CL-59-OTHERA-F01
Sample Depth to Top of Sample ⁽¹⁾								0	0	0	0	0
Sample Depth to Bottom of Sample ⁽¹⁾								0	0	0	0	0
Sample Date								5/6/2004	5/6/2004	5/6/2004	5/6/2004	5/6/2004
QC Code								SA	SA	SA	SA	SA
Study ID								ENSR IRM	ENSR IRM	ENSR IRM	ENSR IRM	ENSR IRM
Sample Round								1	1	1	1	1
Parameter	Units	Maximum Value	Frequency of Detection	NYSDEC TAGM 4046 ⁽²⁾	Number of Exceedances	Number of Detects	Number of Analyses ⁽³⁾	Value (Q)	Value (Q)	Value (Q)	Value (Q)	Value (Q)
Alpha-BHC	UG/KG	0	0%	110	0	0	178	1.8 UJ	9.4 U	1.9 U	1.9 U	1.8 U
Alpha-Chlordane	UG/KG	34	4%		0	7	178	1.8 U	9.4 U	1.9 U	1.9 U	1.8 U
Beta-BHC	UG/KG	2.4	1%	200	0	1	178	1.8 U	9.4 U	1.9 U	1.9 U	1.8 U
Delta-BHC	UG/KG	0	0%	300	0	0	178	1.8 U	9.4 U	1.9 U	1.9 U	1.8 U
Dieldrin	UG/KG	0	0%	44	0	0	178	3.6 U	18 U	3.7 U	3.7 U	3.5 U
Endosulfan I	UG/KG	16	1%	900	0	1	178	1.8 U	9.4 U	1.9 U	1.9 U	1.8 U
Endosulfan II	UG/KG	0	0%	900	0	0	178	3.6 U	18 U	3.7 U	3.7 U	3.5 U
Endosulfan sulfate	UG/KG	6.2	1%	1000	0	1	178	3.6 U	18 U	3.7 U	3.7 U	3.5 U
Endrin	UG/KG	16	2%	100	0	3	178	3.6 U	18 U	3.7 U	3.7 U	3.5 U
Endrin aldehyde	UG/KG	4.9	1%		0	2	178	3.6 U	18 U	3.7 U	3.7 U	3.5 U
Endrin ketone	UG/KG	38	2%		0	4	178	3.6 U	18 U	3.7 U	3.7 U	3.5 U
Gamma-BHC/Lindane	UG/KG	0	0%	60	0	0	178	1.8 U	9.4 U	1.9 U	1.9 U	1.8 U
Gamma-Chlordane	UG/KG	24	8%	540	0	14	178	1.8 U	9.4 U	1.9 U	2.4 J	1.8 U
Heptachlor	UG/KG	0	0%	100	0	0	178	1.8 U	9.4 U	1.9 U	1.9 U	1.8 U
Heptachlor epoxide	UG/KG	3	1%	20	0	2	178	1.8 U	9.4 U	1.9 U	1.9 U	1.8 U
Methoxychlor	UG/KG	0	0%		0	0	178	18 U	94 U	19 U	19 U	18 U
Toxaphene	UG/KG	0	0%		0	0	178	180 U	180 U	190 U	190 U	180 U
Aroclor-1016	UG/KG	0	0%		0	0	178	36 U	37 U	38 U	38 U	36 U
Aroclor-1221	UG/KG	0	0%		0	0	178	36 U	37 U	38 U	38 U	36 U
Aroclor-1232	UG/KG	0	0%		0	0	178	36 U	37 U	38 U	38 U	36 U
Aroclor-1242	UG/KG	0	0%		0	0	178	36 U	37 U	38 U	38 U	36 U
Aroclor-1248	UG/KG	0	0%		0	0	178	36 U	37 U	38 U	38 U	36 U
Aroclor-1254	UG/KG	0	0%	10000	0	0	178	36 U	37 U	38 U	38 U	36 U
Aroclor-1260	UG/KG	79	1%	10000	0	2	178	36 U	37 U	38 U	38 U	36 U
Metals												
Aluminum	MG/KG	18300	100%	19300	0	178	178	6020 J	8210	9070	12200	10600
Antimony	MG/KG	424	58%	5.9	5	104	178	1.1 J	3.2 UJ	1.7 J	2 J	1.5 J
Arsenic	MG/KG	32.2	100%	8.2	7	178	178	3.6 J	5 J	4.2	6.3	6.3
Barium	MG/KG	304	100%	300	1	178	178	67.1 J	59.6	90.4	68	87.5
Beryllium	MG/KG	2.6	99%	1.1	2	176	178	0.31 J	0.23	0.43	0.58	0.6
Cadmium	MG/KG	3.2	86%	2.3	2	153	178	0.21 J	0.27 U	0.23	0.27	0.32 J
Calcium	MG/KG	214000	100%	121000	1	178	178	103000 J	2540	99200	2230	36200
Chromium	MG/KG	39.3	100%	29.6	2	178	178	9.7 J	15.9	13.6	20.7	16.2
Cobalt	MG/KG	47.8	100%	30	2	178	178	5.2 J	9.8	7.2 J	9.3 J	12.8 J
Copper	MG/KG	305	100%	33	19	178	178	16 J	21.4	18.8	17.7	21.1
Cyanide	MG/KG	0	0%	0.35	0	0	9					
Iron	MG/KG	64000	100%	36500	1	178	178	11900 J	20300 J	18400 J	26300 J	22800
Lead	MG/KG	164	100%	24.8	75	178	178	6 J	12.3	7.2 J	8 J	14.3
Magnesium	MG/KG	30200	100%	21500	3	178	178	18600 J	3650	16400 J	4760 J	7060
Manganese	MG/KG	1290	100%	1060	3	178	178	281 J	421	407 J	849 J	908
Mercury	MG/KG	0.95	95%	0.1	37	169	178	0.02 U	0.02 J	0.05	0.03 J	0.03 J
Nickel	MG/KG	88.3	100%	49	3	178	178	17.1 J	26.4	22.1 J	30.9 J	26.9
Potassium	MG/KG	2290	100%	2380	0	178	178	751 J	972	1590	1010	1000
Selenium	MG/KG	1.5	9%	2	0	16	178	0.42 U	0.53 U	0.41 U	0.42 U	0.43 UJ
Silver	MG/KG	2.9	49%	0.75	62	87	178	0.11 U	0.53 U	0.1 U	1.7	1.8
Sodium	MG/KG	4060	99%	172	86	177	178	123 J	92.5	171	99.8	73.1

Table A-2A
SURFACE SOIL SAMPLE RESULTS (0-2 ft.)
SEAD-59
SEAD-59 and SEAD-71 Phase II RI Report
Seneca Army Depot Activity

				SEAD-59	SEAD-59	SEAD-59	SEAD-59	SEAD-59				
				CL-59-04-WN2	CL-59-04-WS1	CL-59-04-WS2	CL-59-04-WW1	CL-59-OTHERA-F01				
				SOIL	SOIL	SOIL	SOIL	SOIL				
				CL-59-04-WN2	CL-59-04-WS1	CL-59-04-WS2	CL-59-04-WW1	CL-59-OTHERA-F01				
Sample Depth to Top of Sample ⁽¹⁾				0	0	0	0	0				
Sample Depth to Bottom of Sample ⁽¹⁾				0	0	0	0	0				
Sample Date				5/6/2004	5/6/2004	5/6/2004	5/6/2004	5/6/2004				
QC Code				SA	SA	SA	SA	SA				
Study ID				ENSR IRM	ENSR IRM	ENSR IRM	ENSR IRM	ENSR IRM				
Sample Round				1	1	1	1	1				
Parameter	Units	Maximum Value	Frequency of Detection	NYSDEC TAGM 4046 ⁽²⁾	Number of Exceedances	Number of Detects	Number of Analyses ⁽³⁾	Value (Q)	Value (Q)	Value (Q)	Value (Q)	Value (Q)
Thallium	MG/KG	1.8	29%	0.7	24	51	178	0.21 U	0.53 U	0.2 U	0.21 U	0.22 U
Vanadium	MG/KG	28.5	100%	150	0	178	178	10.8 J	17.7	15.8	16.5	18
Zinc	MG/KG	341	100%	110	19	178	178	33.3 J	82.2 J	39.9 J	68.5 J	58.1

Note(s):

- (1) - Historical sample depths are presented (I.e. prior to 2002 TCRA)
- (2) - NYSDEC Technical and Administrative Guidance Memorandum (TAGM) HWR-94-4046, Revised January 24, 1994
- (3) - Sample/Duplicate pair are presented as individual samples in this table. Statistical information used Sample Duplicate pairs as a single entity and averaged result values were used in risk assessment analysis.

U = compound was not detected

J = the reported value is an estimated concentration

UJ = the compound was not detected; the associated reporting limit is approximate

R = the data was rejected in the data validating process

NJ = compound was "tentatively identified" and the associated numerical value is approximate

Table A-2A
SURFACE SOIL SAMPLE RESULTS (0-2 ft.)
SEAD-59
SEAD-59 and SEAD-71 Phase II RI Report
Seneca Army Depot Activity

Facility	SEAD-59								SEAD-59			
Location ID	CL-59-OTHERA-WE1								CL-59-OTHERA-WN1			
Maxtrix	SOIL								SOIL			
Sample ID	CL-59-OTHERA-WE1								CL-59-OTHERA-WN1			
Sample Depth to Top of Sample ⁽¹⁾	0								0			
Sample Depth to Bottom of Sample ⁽¹⁾	0								0			
Sample Date	5/6/2004								5/6/2004			
QC Code	SA								SA			
Study ID	ENSR IRM								ENSR IRM			
Sample Round	1								1			
Parameter	Units	Maximum Value	Frequency of Detection	NYSDEC TAGM 4046 ⁽²⁾	Number of Exceedances	Number of Detects	Number of Analyses ⁽³⁾	Value (Q)	Value (Q)	Value (Q)	Value (Q)	
Volatile Organics												
1,1,1-Trichloroethane	UG/KG	0	0%	800	0	0	177	5 U	6 U	5 U	5 U	
1,1,2,2-Tetrachloroethane	UG/KG	0	0%	600	0	0	169	5 U	6 UJ	5 U	5 UJ	
1,1,2-Trichloro-1,2,2-Trifluoroethane	UG/KG	0	0%		0	0	168	5 U	6 U	5 U	5 U	
1,1,2-Trichloroethane	UG/KG	0	0%		0	0	107	5 U	6 U	5 U	5 U	
1,1-Dichloroethane	UG/KG	0	0%	200	0	0	177	5 U	6 U	5 U	5 U	
1,1-Dichloroethene	UG/KG	8	2%	400	0	3	177	5 U	6 U	5 U	5 U	
1,2,3-Trichloropropane	UG/KG	0	0%		0	0	70					
1,2,4-Trichlorobenzene	UG/KG	0	0%	3400	0	0	161	5 U	6 UJ	5 U	5 UJ	
1,2-Dibromo-3-chloropropane	UG/KG	0	0%		0	0	91	5 UJ	6 UJ	5 U	5 UJ	
1,2-Dibromoethane	UG/KG	0	0%		0	0	98	5 U	6 U	5 U	5 U	
1,2-Dichlorobenzene	UG/KG	0	0%	7900	0	0	161	5 U	6 UJ	5 U	5 UJ	
1,2-Dichloroethane	UG/KG	0	0%	100	0	0	177	5 U	6 U	5 U	5 U	
1,2-Dichloroethene (total)	UG/KG	0	0%		0	0	9					
1,2-Dichloropropane	UG/KG	0	0%		0	0	107	5 U	6 U	5 U	5 U	
1,3-Dichlorobenzene	UG/KG	0	0%	1600	0	0	161	5 U	6 UJ	5 U	5 UJ	
1,3-Dichloropropane	UG/KG	0	0%		0	0	70					
1,4-Dichlorobenzene	UG/KG	0	0%	8500	0	0	161	5 U	6 UJ	5 U	5 UJ	
Acetone	UG/KG	550	27%	200	2	47	177	10 U	23 U	5 UJ	5 U	
Benzene	UG/KG	3	4%	60	0	7	177	5 U	6 U	5 U	5 U	
Bromodichloromethane	UG/KG	0	0%		0	0	107	5 U	6 U	5 U	5 U	
Bromoform	UG/KG	0	0%		0	0	107	5 UJ	6 UJ	5 U	5 UJ	
Carbon disulfide	UG/KG	4	3%	2700	0	6	177	5 U	6 U	5 U	5 U	
Carbon tetrachloride	UG/KG	0	0%	600	0	0	177	5 U	6 U	5 U	5 U	
Chlorobenzene	UG/KG	0	0%	1700	0	0	177	5 U	6 U	5 U	5 U	
Chlorodibromomethane	UG/KG	0	0%		0	0	177	5 U	6 U	5 U	5 U	
Chloroethane	UG/KG	0	0%	1900	0	0	177	5 U	6 U	5 UJ	5 U	
Chloroform	UG/KG	0	0%	300	0	0	177	5 U	6 U	5 U	5 U	
Cis-1,2-Dichloroethene	UG/KG	0	0%		0	0	98	5 U	6 U	5 U	5 U	
Cis-1,3-Dichloropropene	UG/KG	0	0%		0	0	107	5 U	6 U	5 U	5 U	
Cyclohexane	UG/KG	3	8%		0	8	98	5 U	6 U	5 U	5 U	
Dichlorodifluoromethane	UG/KG	0	0%		0	0	98	5 U	6 U	5 U	5 U	
Ethyl benzene	UG/KG	4.6	1%	5500	0	2	177	5 U	6 U	5 U	5 U	
Isopropylbenzene	UG/KG	0	0%		0	0	98	5 U	6 U	5 U	5 U	
Meta/Para Xylene	UG/KG	9.4	4%		0	3	70					
Methyl Acetate	UG/KG	2	3%		0	3	98	5 U	6 U	5 U	5 U	
Methyl Tertbutyl Ether	UG/KG	0	0%		0	0	98	5 U	6 U	5 U	5 U	
Methyl bromide	UG/KG	0	0%		0	0	107	5 U	6 U	5 U	5 U	
Methyl butyl ketone	UG/KG	0	0%		0	0	107	5 U	6 U	5 U	5 U	
Methyl chloride	UG/KG	0	0%		0	0	107	5 U	6 U	5 U	5 U	
Methyl cyclohexane	UG/KG	5	10%		0	10	98	5 U	6 U	5 U	5 U	
Methyl ethyl ketone	UG/KG	190	12%	300	0	22	177	5 U	2 J	5 U	5 U	
Methyl isobutyl ketone	UG/KG	1.9	1%	1000	0	1	177	5 U	6 U	5 U	5 U	
Methylene chloride	UG/KG	4.9	20%	100	0	36	178	5 U	6 U	5 U	5 U	
Ortho Xylene	UG/KG	5.05	4%		0	3	70					

Table A-2A
SURFACE SOIL SAMPLE RESULTS (0-2 ft.)
SEAD-59
SEAD-59 and SEAD-71 Phase II RI Report
Seneca Army Depot Activity

Facility	SEAD-59	SEAD-59	SEAD-59	SEAD-59							
Location ID	CL-59-OTHERA-WE1	CL-59-OTHERA-WN1	CL-59-OTHERA-WS1	CL-59-OTHERA-WW1							
Maxtrix	SOIL	SOIL	SOIL	SOIL							
Sample ID	CL-59-OTHERA-WE1	CL-59-OTHERA-WN1	CL-59-OTHERA-WS1	CL-59-OTHERA-WW1							
Sample Depth to Top of Sample ⁽¹⁾	0	0	0	0							
Sample Depth to Bottom of Sample ⁽¹⁾	0	0	0	0							
Sample Date	5/6/2004	5/6/2004	5/6/2004	5/6/2004							
QC Code	SA	SA	SA	SA							
Study ID	ENSR IRM	ENSR IRM	ENSR IRM	ENSR IRM							
Sample Round	1	1	1	1							
Parameter	Units	Maximum Value	Frequency of Detection	NYSDEC TAGM 4046 ⁽²⁾	Number of Exceedances	Number of Detects	Number of Analyses ⁽³⁾	Value (Q)	Value (Q)	Value (Q)	Value (Q)
Styrene	UG/KG	0	0%		0	0	107	5 U	6 U	5 U	5 U
Tetrachloroethene	UG/KG	6.4	3%	1400	0	5	177	5 U	6 U	5 U	5 U
Toluene	UG/KG	8	8%	1500	0	14	177	5 U	6 U	5 U	5 U
Total BTEX	MG/KG	3.25	67%		0	2	3				
Total Xylenes	UG/KG	3	7%	1200	0	7	102	5 U	6 UJ	5 U	5 UJ
Trans-1,2-Dichloroethene	UG/KG	0	0%	300	0	0	168	5 U	6 U	5 U	5 U
Trans-1,3-Dichloropropene	UG/KG	0	0%		0	0	107	5 U	6 U	5 U	5 U
Trichloroethene	UG/KG	4.5	5%	700	0	8	177	5 U	6 U	5 U	5 U
Trichlorofluoromethane	UG/KG	6	1%		0	1	98	5 U	6 U	5 U	5 U
Vinyl chloride	UG/KG	0	0%	200	0	0	177	5 U	6 U	5 U	5 U
Semivolatile Organics											
1,1'-Biphenyl	UG/KG	254.5	2%		0	2	99	370 U	390 U	360 U	370 U
1,2,4-Trichlorobenzene	UG/KG	0	0%	3400	0	0	9				
1,2-Dichlorobenzene	UG/KG	0	0%	7900	0	0	9				
1,3-Dichlorobenzene	UG/KG	0	0%	1600	0	0	9				
1,4-Dichlorobenzene	UG/KG	0	0%	8500	0	0	9				
2,2'-oxybis(1-Chloropropane)	UG/KG	0	0%		0	0	105	370 U	390 U	360 U	370 U
2,4,5-Trichlorophenol	UG/KG	0	0%	100	0	0	178	920 U	990 U	900 U	930 U
2,4,6-Trichlorophenol	UG/KG	0	0%		0	0	178	370 U	390 U	360 U	370 U
2,4-Dichlorophenol	UG/KG	0	0%	400	0	0	178	370 U	390 U	360 U	370 U
2,4-Dimethylphenol	UG/KG	0	0%		0	0	108	370 U	390 U	360 U	370 U
2,4-Dinitrophenol	UG/KG	0	0%	200	0	0	178	920 U	990 U	900 U	930 U
2,4-Dinitrotoluene	UG/KG	0	0%		0	0	178	370 U	390 U	360 U	370 U
2,6-Dinitrotoluene	UG/KG	0	0%	1000	0	0	178	370 U	390 U	360 U	370 U
2-Chloronaphthalene	UG/KG	0	0%		0	0	108	370 U	390 U	360 U	370 U
2-Chlorophenol	UG/KG	0	0%	800	0	0	178	370 U	390 U	360 U	370 U
2-Methylnaphthalene	UG/KG	1295	19%	36400	0	34	178	370 U	390 U	360 U	370 U
2-Methylphenol	UG/KG	0	0%	100	0	0	178	370 U	390 U	360 U	370 U
2-Nitroaniline	UG/KG	0	0%	430	0	0	178	920 U	990 U	900 U	930 U
2-Nitrophenol	UG/KG	0	0%	330	0	0	178	370 U	390 U	360 U	370 U
3,3'-Dichlorobenzidine	UG/KG	0	0%		0	0	178	370 U	390 U	360 U	370 U
3-Nitroaniline	UG/KG	0	0%	500	0	0	178	920 U	990 U	900 U	930 U
4,6-Dinitro-2-methylphenol	UG/KG	0	0%		0	0	108	920 U	990 U	900 U	930 U
4-Bromophenyl phenyl ether	UG/KG	0	0%		0	0	108	370 U	390 U	360 U	370 U
4-Chloro-3-methylphenol	UG/KG	0	0%	240	0	0	178	370 U	390 U	360 U	370 U
4-Chloroaniline	UG/KG	1200	1%	220	1	2	178	370 U	390 U	360 U	370 U
4-Chlorophenyl phenyl ether	UG/KG	0	0%		0	0	108	370 U	390 U	360 U	370 U
4-Methylphenol	UG/KG	150	3%	900	0	5	178	370 U	390 U	360 U	370 U
4-Nitroaniline	UG/KG	0	0%		0	0	108	920 U	990 U	900 U	930 U
4-Nitrophenol	UG/KG	0	0%	100	0	0	178	920 U	990 U	900 U	930 U
Acenaphthene	UG/KG	2680	24%	50000	0	42	178	370 U	390 U	360 U	370 U
Acenaphthylene	UG/KG	1700	37%	41000	0	66	178	370 U	390 U	360 U	370 U
Acetophenone	UG/KG	0	0%		0	0	99	370 U	390 U	360 U	370 U
Aniline	UG/KG	0	0%		0	0	70				
Anthracene	UG/KG	4395	43%	50000	0	77	178	370 U	390 U	360 U	370 U

Table A-2A
SURFACE SOIL SAMPLE RESULTS (0-2 ft.)
SEAD-59
SEAD-59 and SEAD-71 Phase II RI Report
Seneca Army Depot Activity

Facility	SEAD-59								SEAD-59	SEAD-59	SEAD-59	SEAD-59
Location ID	CL-59-OTHERA-WE1								CL-59-OTHERA-WN1	CL-59-OTHERA-WS1	CL-59-OTHERA-WW1	CL-59-OTHERA-WW1
Matrix	SOIL								SOIL	SOIL	SOIL	SOIL
Sample ID	CL-59-OTHERA-WE1								CL-59-OTHERA-WN1	CL-59-OTHERA-WS1	CL-59-OTHERA-WW1	CL-59-OTHERA-WW1
Sample Depth to Top of Sample ⁽¹⁾	0								0	0	0	0
Sample Depth to Bottom of Sample ⁽¹⁾	0								0	0	0	0
Sample Date	5/6/2004								5/6/2004	5/6/2004	5/6/2004	5/6/2004
QC Code	SA								SA	SA	SA	SA
Study ID	ENSR IRM								ENSR IRM	ENSR IRM	ENSR IRM	ENSR IRM
Sample Round	1								1	1	1	1
Parameter	Units	Maximum Value	Frequency of Detection	NYSDEC TAGM 4046 ⁽²⁾	Number of Exceedances	Number of Detects	Number of Analyses ⁽³⁾	Value (Q)	Value (Q)	Value (Q)	Value (Q)	
Atrazine	UG/KG	120	1%		0	1	99	370 U	390 U	360 U	370 U	
Benzaldehyde	UG/KG	50	1%		0	1	99	370 U	390 U	360 U	370 U	
Benzo(a)anthracene	UG/KG	8900	51%	224	72	90	178	370 U	390 U	360 U	370 U	
Benzo(a)pyrene	UG/KG	8050	51%	61	84	91	178	370 U	390 U	360 U	370 U	
Benzo(b)fluoranthene	UG/KG	6800	52%	1100	40	92	178	370 U	390 U	360 U	370 U	
Benzo(ghi)perylene	UG/KG	5200	46%	50000	0	82	178	370 U	390 U	360 U	370 U	
Benzo(k)fluoranthene	UG/KG	7350	49%	1100	35	88	178	370 U	390 U	360 U	370 U	
Benzoic Acid	UG/KG	0	0%	2700	0	0	70					
Bis(2-Chloroethoxy)methane	UG/KG	0	0%		0	0	108	370 U	390 U	360 U	370 U	
Bis(2-Chloroethyl)ether	UG/KG	0	0%		0	0	108	370 U	390 U	360 U	370 U	
Bis(2-Chloroisopropyl)ether	UG/KG	0	0%		0	0	3					
Bis(2-Ethylhexyl)phthalate	UG/KG	990	19%	50000	0	34	178	370 U	390 U	360 U	370 U	
Butylbenzylphthalate	UG/KG	0	0%	50000	0	0	178	370 U	390 U	360 U	370 U	
Caprolactam	UG/KG	0	0%		0	0	99	370 U	390 U	360 U	370 U	
Carbazole	UG/KG	755	19%		0	20	108	370 U	390 U	360 U	370 U	
Chrysene	UG/KG	8900	51%	400	62	91	178	370 U	390 U	360 U	370 U	
Di-n-butylphthalate	UG/KG	965	2%	8100	0	4	178	370 U	390 U	360 U	370 U	
Di-n-octylphthalate	UG/KG	0	0%	50000	0	0	178	370 U	390 U	360 U	370 U	
Dibenz(a,h)anthracene	UG/KG	1665	38%	14	67	68	178	370 U	390 U	360 U	370 U	
Dibenzofuran	UG/KG	2350	16%	6200	0	28	178	370 U	390 U	360 U	370 U	
Diethyl phthalate	UG/KG	10	1%	7100	0	1	178	370 U	390 U	360 U	370 U	
Dimethylphthalate	UG/KG	0	0%	2000	0	0	178	370 U	390 U	360 U	370 U	
Fluoranthene	UG/KG	23500	54%	50000	0	97	178	370 U	390 U	59 J	370 U	
Fluorene	UG/KG	2640	28%	50000	0	49	178	370 U	390 U	360 U	370 U	
Hexachlorobenzene	UG/KG	0	0%	410	0	0	178	370 U	390 U	360 U	370 U	
Hexachlorobutadiene	UG/KG	0	0%		0	0	178	370 U	390 U	360 U	370 U	
Hexachlorocyclopentadiene	UG/KG	0	0%		0	0	108	370 U	390 U	360 U	370 U	
Hexachloroethane	UG/KG	0	0%		0	0	178	370 U	390 U	360 U	370 U	
Indeno(1,2,3-cd)pyrene	UG/KG	4950	47%	3200	2	84	178	370 U	390 U	360 U	370 U	
Isophorone	UG/KG	0	0%	4400	0	0	178	370 U	390 U	360 U	370 U	
N-Nitrosodiphenylamine	UG/KG	100	1%		0	1	108	370 U	390 U	360 U	370 U	
N-Nitrosodipropylamine	UG/KG	0	0%		0	0	108	370 U	390 U	360 U	370 U	
Naphthalene	UG/KG	1800	19%	13000	0	34	178	370 U	390 U	360 U	370 U	
Nitrobenzene	UG/KG	0	0%	200	0	0	178	370 U	390 U	360 U	370 U	
Pentachlorophenol	UG/KG	0	0%	1000	0	0	178	920 U	990 U	900 U	930 U	
Phenanthrene	UG/KG	21300	51%	50000	0	90	178	370 U	390 U	360 U	370 U	
Phenol	UG/KG	0	0%	30	0	0	178	370 U	390 U	360 U	370 U	
Pyrene	UG/KG	19200	55%	50000	0	98	178	370 U	390 U	60 J	370 U	
Pyridine	UG/KG	0	0%		0	0	100					
Total Unknown PAHs as SV	MG/KG	25	100%		0	3	3					
Pesticides/PCBs												
4,4'-DDD	UG/KG	740	28%	2900	0	49	178	3.6 U	3.9 U	3.6 U	3.7 U	
4,4'-DDE	UG/KG	2600	37%	2100	1	65	178	3.6 U	3.9 U	4	3.7 U	
4,4'-DDT	UG/KG	3700	33%	2100	1	59	178	3.6 U	3.9 U	3.6 U	3.7 U	
Aldrin	UG/KG	1.2	1%	41	0	1	178	1.8 U	2 U	1.8 U	1.9 U	

**Table A-2A
SURFACE SOIL SAMPLE RESULTS (0-2 ft.)
SEAD-59
SEAD-59 and SEAD-71 Phase II RI Report
Seneca Army Depot Activity**

				SEAD-59	SEAD-59	SEAD-59	SEAD-59				
Facility				CL-59-OTHERA-WE1	CL-59-OTHERA-WN1	CL-59-OTHERA-WS1	CL-59-OTHERA-WW1				
Location ID				SOIL	SOIL	SOIL	SOIL				
Matrix				CL-59-OTHERA-WE1	CL-59-OTHERA-WN1	CL-59-OTHERA-WS1	CL-59-OTHERA-WW1				
Sample ID				0	0	0	0				
Sample Depth to Top of Sample ⁽¹⁾				0	0	0	0				
Sample Depth to Bottom of Sample ⁽¹⁾				0	0	0	0				
Sample Date				5/6/2004	5/6/2004	5/6/2004	5/6/2004				
QC Code				SA	SA	SA	SA				
Study ID				ENSR IRM	ENSR IRM	ENSR IRM	ENSR IRM				
Sample Round				1	1	1	1				
Parameter	Units	Maximum Value	Frequency of Detection	NYSDEC TAGM 4046 ⁽²⁾	Number of Exceedances	Number of Detects	Number of Analyses ⁽³⁾	Value (Q)	Value (Q)	Value (Q)	Value (Q)
Alpha-BHC	UG/KG	0	0%	110	0	0	178	1.8 U	2 U	1.8 U	1.9 U
Alpha-Chlordane	UG/KG	34	4%		0	7	178	1.8 U	2 U	1.8 U	1.9 U
Beta-BHC	UG/KG	2.4	1%	200	0	1	178	1.8 U	2 U	1.8 U	1.9 U
Delta-BHC	UG/KG	0	0%	300	0	0	178	1.8 U	2 U	1.8 U	1.9 U
Dieldrin	UG/KG	0	0%	44	0	0	178	3.6 U	3.9 U	3.6 U	3.7 U
Endosulfan I	UG/KG	16	1%	900	0	1	178	1.8 U	2 U	1.8 U	1.9 U
Endosulfan II	UG/KG	0	0%	900	0	0	178	3.6 U	3.9 U	3.6 U	3.7 U
Endosulfan sulfate	UG/KG	6.2	1%	1000	0	1	178	3.6 U	3.9 U	3.6 U	3.7 U
Endrin	UG/KG	16	2%	100	0	3	178	3.6 U	3.9 U	3.6 U	3.7 U
Endrin aldehyde	UG/KG	4.9	1%		0	2	178	3.6 U	3.9 U	3.6 U	3.7 U
Endrin ketone	UG/KG	38	2%		0	4	178	3.6 U	3.9 U	3.6 U	3.7 U
Gamma-BHC/Lindane	UG/KG	0	0%	60	0	0	178	1.8 U	2 U	1.8 U	1.9 U
Gamma-Chlordane	UG/KG	24	8%	540	0	14	178	1.8 U	2 U	1.8 U	1.9 U
Heptachlor	UG/KG	0	0%	100	0	0	178	1.8 U	2 U	1.8 U	1.9 U
Heptachlor epoxide	UG/KG	3	1%	20	0	2	178	1.8 U	2 U	1.8 U	1.9 U
Methoxychlor	UG/KG	0	0%		0	0	178	18 U	20 U	18 U	19 U
Toxaphene	UG/KG	0	0%		0	0	178	180 U	200 U	180 U	190 U
Aroclor-1016	UG/KG	0	0%		0	0	178	36 U	40 U	36 U	38 U
Aroclor-1221	UG/KG	0	0%		0	0	178	36 U	40 U	36 U	38 U
Aroclor-1232	UG/KG	0	0%		0	0	178	36 U	40 U	36 U	38 U
Aroclor-1242	UG/KG	0	0%		0	0	178	36 U	40 U	36 U	38 U
Aroclor-1248	UG/KG	0	0%		0	0	178	36 U	40 U	36 U	38 U
Aroclor-1254	UG/KG	0	0%	10000	0	0	178	36 U	40 U	36 U	38 U
Aroclor-1260	UG/KG	79	1%	10000	0	2	178	36 U	40 U	36 U	38 U
Metals											
Aluminum	MG/KG	18300	100%	19300	0	178	178	13700	16800	11600	12500
Antimony	MG/KG	424	58%	5.9	5	104	178	1.1 J	1.4 J	0.9 J	1.5 J
Arsenic	MG/KG	32.2	100%	8.2	7	178	178	6.7	6.5	8.3	6
Barium	MG/KG	304	100%	300	1	178	178	135	198	126	166
Beryllium	MG/KG	2.6	99%	1.1	2	176	178	0.72	1.1	0.69	0.67
Cadmium	MG/KG	3.2	86%	2.3	2	153	178	0.21 J	0.51	0.44	0.51
Calcium	MG/KG	214000	100%	121000	1	178	178	2780	6310	5590	4390
Chromium	MG/KG	39.3	100%	29.6	2	178	178	19.1	21.4	16.9	16.5
Cobalt	MG/KG	47.8	100%	30	2	178	178	7.9 J	9.8 J	14.4 J	10.2 J
Copper	MG/KG	305	100%	33	19	178	178	16.4	31.6	20.3	12.9
Cyanide	MG/KG	0	0%	0.35	0	0	9				
Iron	MG/KG	64000	100%	36500	1	178	178	25100	26500	26000	23700
Lead	MG/KG	164	100%	24.8	75	178	178	12.1	19	37	31.4
Magnesium	MG/KG	30200	100%	21500	3	178	178	3510	3910	3970	2530
Manganese	MG/KG	1290	100%	1060	3	178	178	288	837	1170	1050
Mercury	MG/KG	0.95	95%	0.1	37	169	178	0.03 J	0.14	0.14	0.11
Nickel	MG/KG	88.3	100%	49	3	178	178	20.2	25.3	24.7	15.4
Potassium	MG/KG	2290	100%	2380	0	178	178	971	1230	895	831
Selenium	MG/KG	1.5	9%	2	0	16	178	0.44 UJ	0.48 UJ	0.43 UJ	0.45 UJ
Silver	MG/KG	2.9	49%	0.75	62	87	178	2.5	2.9	2.6	2.6
Sodium	MG/KG	4060	99%	172	86	177	178	93.6	49.8 J	39.6 J	35.9 J

Table A-2A
SURFACE SOIL SAMPLE RESULTS (0-2 ft.)
SEAD-59
SEAD-59 and SEAD-71 Phase II RI Report
Seneca Army Depot Activity

				SEAD-59	SEAD-59	SEAD-59	SEAD-59				
Facility				CL-59-OTHERA-WE1	CL-59-OTHERA-WN1	CL-59-OTHERA-WS1	CL-59-OTHERA-WW1				
Location ID				SOIL	SOIL	SOIL	SOIL				
Maxtrix				CL-59-OTHERA-WE1	CL-59-OTHERA-WN1	CL-59-OTHERA-WS1	CL-59-OTHERA-WW1				
Sample ID				0	0	0	0				
Sample Depth to Top of Sample ⁽¹⁾				0	0	0	0				
Sample Depth to Bottom of Sample ⁽¹⁾				5/6/2004	5/6/2004	5/6/2004	5/6/2004				
Sample Date				SA	SA	SA	SA				
QC Code				ENSR IRM	ENSR IRM	ENSR IRM	ENSR IRM				
Study ID				1	1	1	1				
Sample Round											
Parameter	Units	Maximum Value	Frequency of Detection	NYSDEC TAGM 4046 ⁽²⁾	Number of Exceedances	Number of Detects	Number of Analyses ⁽³⁾	Value (Q)	Value (Q)	Value (Q)	Value (Q)
Thallium	MG/KG	1.8	29%	0.7	24	51	178	0.22 U	0.24 U	0.21 U	0.23 U
Vanadium	MG/KG	28.5	100%	150	0	178	178	25.4	26.1	22.8	22.9
Zinc	MG/KG	341	100%	110	19	178	178	46.1	73.5	54	46.2

- Note(s):
- (1) - Historical sample depths are presented (I.e. prior to 2002 TCRA)
 - (2) - NYSDEC Technical and Administrative Guidance Memorandum (TAGM) HWR-94-4046, Revised January 24, 1994
 - (3) - Sample/Duplicate pair are presented as individual samples in this table. Statistical information used Sample Duplicate pairs as a single entity and averaged result values were used in risk assessment analysis.

U = compound was not detected
J = the reported value is an estimated concentration
UJ = the compound was not detected; the associated reporting limit is approximate
R = the data was rejected in the data validating process
NJ = compound was "tentatively identified" and the associated numerical value is approximate

Table A-2A
SURFACE SOIL SAMPLE RESULTS (0-2 ft.)
SEAD-59
SEAD-59 and SEAD-71 Phase II RI Report
Seneca Army Depot Activity

Facility	SEAD-59										
Location ID	CL-59-OTHERB-F01	CL-59-OTHERB-WE1	CL-59-OTHERB-WN1	CL-59-OTHERB-WS1							
Matrix	SOIL										
Sample ID	CL-59-OTHERB-F01	CL-59-OTHERB-WE1	CL-59-OTHERB-WN1	CL-59-OTHERB-WS1							
Sample Depth to Top of Sample ⁽¹⁾	0	0	0	0							
Sample Depth to Bottom of Sample ⁽¹⁾	0	0	0	0							
Sample Date	5/6/2004	5/6/2004	5/6/2004	5/6/2004							
QC Code	SA	SA	SA	SA							
Study ID	ENSR IRM	ENSR IRM	ENSR IRM	ENSR IRM							
Sample Round	1	1	1	1							
Parameter	Units	Maximum Value	Frequency of Detection	NYSDEC TAGM 4046 ⁽²⁾	Number of Exceedances	Number of Detects	Number of Analyses ⁽³⁾	Value (Q)	Value (Q)	Value (Q)	Value (Q)
Volatile Organics											
1,1,1-Trichloroethane	UG/KG	0	0%	800	0	0	177	4 U	6 U	5 U	5 U
1,1,2,2-Tetrachloroethane	UG/KG	0	0%	600	0	0	169	4 U	6 UJ	5 U	5 U
1,1,2-Trichloro-1,2,2-Trifluoroethane	UG/KG	0	0%		0	0	168	4 U	6 U	5 U	5 U
1,1,2-Trichloroethane	UG/KG	0	0%		0	0	107	4 U	6 U	5 U	5 U
1,1-Dichloroethane	UG/KG	0	0%	200	0	0	177	4 U	6 U	5 U	5 U
1,1-Dichloroethene	UG/KG	8	2%	400	0	3	177	4 U	6 U	5 U	5 U
1,2,3-Trichloropropane	UG/KG	0	0%		0	0	70				
1,2,4-Trichlorobenzene	UG/KG	0	0%	3400	0	0	161	4 U	6 UJ	5 U	5 U
1,2-Dibromo-3-chloropropane	UG/KG	0	0%		0	0	91	4 U	6 UJ	5 U	5 UJ
1,2-Dibromoethane	UG/KG	0	0%		0	0	98	4 U	6 UJ	5 U	5 U
1,2-Dichlorobenzene	UG/KG	0	0%	7900	0	0	161	4 U	6 UJ	5 U	5 U
1,2-Dichloroethane	UG/KG	0	0%	100	0	0	177	4 U	6 U	5 U	5 U
1,2-Dichloroethene (total)	UG/KG	0	0%		0	0	9				
1,2-Dichloropropane	UG/KG	0	0%		0	0	107	4 U	6 U	5 U	5 U
1,3-Dichlorobenzene	UG/KG	0	0%	1600	0	0	161	4 U	6 UJ	5 U	5 U
1,3-Dichloropropane	UG/KG	0	0%		0	0	70				
1,4-Dichlorobenzene	UG/KG	0	0%	8500	0	0	161	4 U	6 UJ	5 U	5 U
Acetone	UG/KG	550	27%	200	2	47	177	4 UJ	35 NJ	5 UJ	14 U
Benzene	UG/KG	3	4%	60	0	7	177	4 U	6 U	5 U	5 U
Bromodichloromethane	UG/KG	0	0%		0	0	107	4 U	6 U	5 U	5 U
Bromoform	UG/KG	0	0%		0	0	107	4 U	6 UJ	5 U	5 UJ
Carbon disulfide	UG/KG	4	3%	2700	0	6	177	4 U	6 U	5 U	5 U
Carbon tetrachloride	UG/KG	0	0%	600	0	0	177	4 U	6 U	5 U	5 U
Chlorobenzene	UG/KG	0	0%	1700	0	0	177	4 U	6 UJ	5 U	5 U
Chlorodibromomethane	UG/KG	0	0%		0	0	177	4 U	6 UJ	5 U	5 U
Chloroethane	UG/KG	0	0%	1900	0	0	177	4 UJ	6 U	5 UJ	5 U
Chloroform	UG/KG	0	0%	300	0	0	177	4 U	6 U	5 U	5 U
Cis-1,2-Dichloroethene	UG/KG	0	0%		0	0	98	4 U	6 U	5 U	5 U
Cis-1,3-Dichloropropene	UG/KG	0	0%		0	0	107	4 U	6 U	5 U	5 U
Cyclohexane	UG/KG	3	8%		0	8	98	4 U	6 U	5 U	5 U
Dichlorodifluoromethane	UG/KG	0	0%		0	0	98	4 U	6 U	5 U	5 U
Ethyl benzene	UG/KG	4.6	1%	5500	0	2	177	4 U	6 UJ	5 U	5 U
Isopropylbenzene	UG/KG	0	0%		0	0	98	4 U	6 UJ	5 U	5 U
Meta/Para Xylene	UG/KG	9.4	4%		0	3	70				
Methyl Acetate	UG/KG	2	3%		0	3	98	4 U	2 J	5 U	1 J
Methyl Tertbutyl Ether	UG/KG	0	0%		0	0	98	4 U	6 U	5 U	5 U
Methyl bromide	UG/KG	0	0%		0	0	107	4 U	6 U	5 U	5 U
Methyl butyl ketone	UG/KG	0	0%		0	0	107	4 U	6 UJ	5 U	5 U
Methyl chloride	UG/KG	0	0%		0	0	107	4 U	6 U	5 U	5 U
Methyl cyclohexane	UG/KG	5	10%		0	10	98	4 U	6 U	5 U	5 U
Methyl ethyl ketone	UG/KG	190	12%	300	0	22	177	4 U	2 J	5 U	5 U
Methyl isobutyl ketone	UG/KG	1.9	1%	1000	0	1	177	4 U	6 U	5 U	5 U
Methylene chloride	UG/KG	4.9	20%	100	0	36	178	4 U	6 U	5 U	5 U
Ortho Xylene	UG/KG	5.05	4%		0	3	70				

Table A-2A
SURFACE SOIL SAMPLE RESULTS (0-2 ft.)
SEAD-59
SEAD-59 and SEAD-71 Phase II RI Report
Seneca Army Depot Activity

Facility	SEAD-59	SEAD-59	SEAD-59	SEAD-59							
Location ID	CL-59-OTHERB-F01	CL-59-OTHERB-WE1	CL-59-OTHERB-WN1	CL-59-OTHERB-WS1							
Maxtrix	SOIL	SOIL	SOIL	SOIL							
Sample ID	CL-59-OTHERB-F01	CL-59-OTHERB-WE1	CL-59-OTHERB-WN1	CL-59-OTHERB-WS1							
Sample Depth to Top of Sample ⁽¹⁾	0	0	0	0							
Sample Depth to Bottom of Sample ⁽¹⁾	0	0	0	0							
Sample Date	5/6/2004	5/6/2004	5/6/2004	5/6/2004							
QC Code	SA	SA	SA	SA							
Study ID	ENSR IRM	ENSR IRM	ENSR IRM	ENSR IRM							
Sample Round	1	1	1	1							
Parameter	Units	Maximum Value	Frequency of Detection	NYSDEC TAGM 4046 ⁽²⁾	Number of Exceedances	Number of Detects	Number of Analyses ⁽³⁾	Value (Q)	Value (Q)	Value (Q)	Value (Q)
Styrene	UG/KG	0	0%		0	0	107	4 U	6 UJ	5 U	5 U
Tetrachloroethene	UG/KG	6.4	3%	1400	0	5	177	4 U	6 UJ	5 U	5 U
Toluene	UG/KG	8	8%	1500	0	14	177	4 U	6 U	5 U	5 U
Total BTEX	MG/KG	3.25	67%		0	2	3				
Total Xylenes	UG/KG	3	7%	1200	0	7	102	4 U	6 UJ	5 U	5 U
Trans-1,2-Dichloroethene	UG/KG	0	0%	300	0	0	168	4 U	6 U	5 U	5 U
Trans-1,3-Dichloropropene	UG/KG	0	0%		0	0	107	4 U	6 U	5 U	5 U
Trichloroethene	UG/KG	4.5	5%	700	0	8	177	4 U	6 U	5 U	5 U
Trichlorofluoromethane	UG/KG	6	1%		0	1	98	4 U	6 U	5 U	5 U
Vinyl chloride	UG/KG	0	0%	200	0	0	177	4 U	6 U	5 U	5 U
Semivolatile Organics											
1,1'-Biphenyl	UG/KG	254.5	2%		0	2	99	360 U	370 U	370 U	350 U
1,2,4-Trichlorobenzene	UG/KG	0	0%	3400	0	0	9				
1,2-Dichlorobenzene	UG/KG	0	0%	7900	0	0	9				
1,3-Dichlorobenzene	UG/KG	0	0%	1600	0	0	9				
1,4-Dichlorobenzene	UG/KG	0	0%	8500	0	0	9				
2,2'-oxybis(1-Chloropropane)	UG/KG	0	0%		0	0	105	360 U	370 U	370 U	350 U
2,4,5-Trichlorophenol	UG/KG	0	0%	100	0	0	178	910 U	930 U	920 U	870 U
2,4,6-Trichlorophenol	UG/KG	0	0%		0	0	178	360 U	370 U	370 U	350 U
2,4-Dichlorophenol	UG/KG	0	0%	400	0	0	178	360 U	370 U	370 U	350 U
2,4-Dimethylphenol	UG/KG	0	0%		0	0	108	360 U	370 U	370 U	350 U
2,4-Dinitrophenol	UG/KG	0	0%	200	0	0	178	910 U	930 U	920 U	870 U
2,4-Dinitrotoluene	UG/KG	0	0%		0	0	178	360 U	370 U	370 U	350 U
2,6-Dinitrotoluene	UG/KG	0	0%	1000	0	0	178	360 U	370 U	370 U	350 U
2-Chloronaphthalene	UG/KG	0	0%		0	0	108	360 U	370 U	370 U	350 U
2-Chlorophenol	UG/KG	0	0%	800	0	0	178	360 U	370 U	370 U	350 U
2-Methylnaphthalene	UG/KG	1295	19%	36400	0	34	178	360 U	370 U	370 U	350 U
2-Methylphenol	UG/KG	0	0%	100	0	0	178	360 U	370 U	370 U	350 U
2-Nitroaniline	UG/KG	0	0%	430	0	0	178	910 U	930 U	920 U	870 U
2-Nitrophenol	UG/KG	0	0%	330	0	0	178	360 U	370 U	370 U	350 U
3,3'-Dichlorobenzidine	UG/KG	0	0%		0	0	178	360 U	370 U	370 U	350 U
3-Nitroaniline	UG/KG	0	0%	500	0	0	178	910 U	930 U	920 U	870 U
4,6-Dinitro-2-methylphenol	UG/KG	0	0%		0	0	108	910 U	930 U	920 U	870 U
4-Bromophenyl phenyl ether	UG/KG	0	0%		0	0	108	360 U	370 U	370 U	350 U
4-Chloro-3-methylphenol	UG/KG	0	0%	240	0	0	178	360 U	370 U	370 U	350 U
4-Chloroaniline	UG/KG	1200	1%	220	1	2	178	360 U	370 U	370 U	350 U
4-Chlorophenyl phenyl ether	UG/KG	0	0%		0	0	108	360 U	370 U	370 U	350 U
4-Methylphenol	UG/KG	150	3%	900	0	5	178	360 U	370 U	370 U	350 U
4-Nitroaniline	UG/KG	0	0%		0	0	108	910 U	930 U	920 U	870 U
4-Nitrophenol	UG/KG	0	0%	100	0	0	178	910 U	930 U	920 U	870 U
Acenaphthene	UG/KG	2680	24%	50000	0	42	178	360 U	370 U	370 U	350 U
Acenaphthylene	UG/KG	1700	37%	41000	0	66	178	360 U	370 U	370 U	350 U
Acetophenone	UG/KG	0	0%		0	0	99	360 U	370 U	370 U	350 U
Aniline	UG/KG	0	0%		0	0	70				
Anthracene	UG/KG	4395	43%	50000	0	77	178	360 U	370 U	370 U	350 U

Table A-2A
SURFACE SOIL SAMPLE RESULTS (0-2 ft.)
SEAD-59
SEAD-59 and SEAD-71 Phase II RI Report
Seneca Army Depot Activity

Facility	SEAD-59								SEAD-59	SEAD-59	SEAD-59	SEAD-59
Location ID	CL-59-OTHERB-F01								CL-59-OTHERB-WE1	CL-59-OTHERB-WN1	CL-59-OTHERB-WS1	CL-59-OTHERB-WS1
Matrix	SOIL								SOIL	SOIL	SOIL	SOIL
Sample ID	CL-59-OTHERB-F01								CL-59-OTHERB-WE1	CL-59-OTHERB-WN1	CL-59-OTHERB-WS1	CL-59-OTHERB-WS1
Sample Depth to Top of Sample ⁽¹⁾	0								0	0	0	0
Sample Depth to Bottom of Sample ⁽¹⁾	0								0	0	0	0
Sample Date	5/6/2004								5/6/2004	5/6/2004	5/6/2004	5/6/2004
QC Code	SA								SA	SA	SA	SA
Study ID	ENSR IRM								ENSR IRM	ENSR IRM	ENSR IRM	ENSR IRM
Sample Round	1								1	1	1	1
Parameter	Units	Maximum Value	Frequency of Detection	NYSDEC TAGM 4046 ⁽²⁾	Number of Exceedances	Number of Detects	Number of Analyses ⁽³⁾	Value (Q)	Value (Q)	Value (Q)	Value (Q)	
Atrazine	UG/KG	120	1%		0	1	99	360 U	370 U	370 U	350 U	
Benzaldehyde	UG/KG	50	1%		0	1	99	360 U	370 U	370 U	350 U	
Benzo(a)anthracene	UG/KG	8900	51%	224	72	90	178	360 U	370 U	370 U	350 U	
Benzo(a)pyrene	UG/KG	8050	51%	61	84	91	178	360 U	370 U	370 U	350 U	
Benzo(b)fluoranthene	UG/KG	6800	52%	1100	40	92	178	360 U	370 U	370 U	350 U	
Benzo(ghi)perylene	UG/KG	5200	46%	50000	0	82	178	360 U	370 U	370 U	350 U	
Benzo(k)fluoranthene	UG/KG	7350	49%	1100	35	88	178	360 U	370 U	370 U	350 U	
Benzoic Acid	UG/KG	0	0%	2700	0	0	70					
Bis(2-Chloroethoxy)methane	UG/KG	0	0%		0	0	108	360 U	370 U	370 U	350 U	
Bis(2-Chloroethyl)ether	UG/KG	0	0%		0	0	108	360 U	370 U	370 U	350 U	
Bis(2-Chloroisopropyl)ether	UG/KG	0	0%		0	0	3					
Bis(2-Ethylhexyl)phthalate	UG/KG	990	19%	50000	0	34	178	360 U	370 U	370 U	350 U	
Butylbenzylphthalate	UG/KG	0	0%	50000	0	0	178	360 U	370 U	370 U	350 U	
Caprolactam	UG/KG	0	0%		0	0	99	360 U	370 U	370 U	350 U	
Carbazole	UG/KG	755	19%		0	20	108	360 U	370 U	370 U	350 U	
Chrysene	UG/KG	8900	51%	400	62	91	178	360 U	370 U	370 U	350 U	
Di-n-butylphthalate	UG/KG	965	2%	8100	0	4	178	360 U	370 U	370 U	350 U	
Di-n-octylphthalate	UG/KG	0	0%	50000	0	0	178	360 U	370 U	370 U	350 U	
Dibenz(a,h)anthracene	UG/KG	1665	38%	14	67	68	178	360 U	370 U	370 U	350 U	
Dibenzofuran	UG/KG	2350	16%	6200	0	28	178	360 U	370 U	370 U	350 U	
Diethyl phthalate	UG/KG	10	1%	7100	0	1	178	360 U	370 U	370 U	350 U	
Dimethylphthalate	UG/KG	0	0%	2000	0	0	178	360 U	370 U	370 U	350 U	
Fluoranthene	UG/KG	23500	54%	50000	0	97	178	360 U	370 U	370 U	350 U	
Fluorene	UG/KG	2640	28%	50000	0	49	178	360 U	370 U	370 U	350 U	
Hexachlorobenzene	UG/KG	0	0%	410	0	0	178	360 U	370 U	370 U	350 U	
Hexachlorobutadiene	UG/KG	0	0%		0	0	178	360 U	370 U	370 U	350 U	
Hexachlorocyclopentadiene	UG/KG	0	0%		0	0	108	360 U	370 U	370 U	350 U	
Hexachloroethane	UG/KG	0	0%		0	0	178	360 U	370 U	370 U	350 U	
Indeno(1,2,3-cd)pyrene	UG/KG	4950	47%	3200	2	84	178	360 U	370 U	370 U	350 U	
Isophorone	UG/KG	0	0%	4400	0	0	178	360 U	370 U	370 U	350 U	
N-Nitrosodiphenylamine	UG/KG	100	1%		0	1	108	360 U	370 U	370 U	350 U	
N-Nitrosodipropylamine	UG/KG	0	0%		0	0	108	360 U	370 U	370 U	350 U	
Naphthalene	UG/KG	1800	19%	13000	0	34	178	360 U	370 U	370 U	350 U	
Nitrobenzene	UG/KG	0	0%	200	0	0	178	360 U	370 U	370 U	350 U	
Pentachlorophenol	UG/KG	0	0%	1000	0	0	178	910 U	930 U	920 U	870 U	
Phenanthrene	UG/KG	21300	51%	50000	0	90	178	360 U	370 U	370 U	350 U	
Phenol	UG/KG	0	0%	30	0	0	178	360 U	370 U	370 U	350 U	
Pyrene	UG/KG	19200	55%	50000	0	98	178	360 U	370 U	370 U	350 U	
Pyridine	UG/KG	0	0%		0	0	100					
Total Unknown PAHs as SV	MG/KG	25	100%		0	3	3					
Pesticides/PCBs												
4,4'-DDD	UG/KG	740	28%	2900	0	49	178	3.6 U	3.7 U	3.6 U	3.5 U	
4,4'-DDE	UG/KG	2600	37%	2100	1	65	178	3.6 U	3.7 U	3.6 U	3.5 U	
4,4'-DDT	UG/KG	3700	33%	2100	1	59	178	3.6 U	3.7 U	3.6 U	3.5 U	
Aldrin	UG/KG	1.2	1%	41	0	1	178	1.9 U	1.9 U	1.9 U	1.8 U	

Table A-2A
SURFACE SOIL SAMPLE RESULTS (0-2 ft.)
SEAD-59
SEAD-59 and SEAD-71 Phase II RI Report
Seneca Army Depot Activity

Facility	SEAD-59	SEAD-59	SEAD-59	SEAD-59							
Location ID	CL-59-OTHERB-F01	CL-59-OTHERB-WE1	CL-59-OTHERB-WN1	CL-59-OTHERB-WS1							
Matrix	SOIL	SOIL	SOIL	SOIL							
Sample ID	CL-59-OTHERB-F01	CL-59-OTHERB-WE1	CL-59-OTHERB-WN1	CL-59-OTHERB-WS1							
Sample Depth to Top of Sample ⁽¹⁾	0	0	0	0							
Sample Depth to Bottom of Sample ⁽¹⁾	0	0	0	0							
Sample Date	5/6/2004	5/6/2004	5/6/2004	5/6/2004							
QC Code	SA	SA	SA	SA							
Study ID	ENSR IRM	ENSR IRM	ENSR IRM	ENSR IRM							
Sample Round	1	1	1	1							
Parameter	Units	Maximum Value	Frequency of Detection	NYSDEC TAGM 4046 ⁽²⁾	Number of Exceedances	Number of Detects	Number of Analyses ⁽³⁾	Value (Q)	Value (Q)	Value (Q)	Value (Q)
Alpha-BHC	UG/KG	0	0%	110	0	0	178	1.9 U	1.9 U	1.9 U	1.8 U
Alpha-Chlordane	UG/KG	34	4%		0	7	178	1.9 U	1.9 U	1.9 U	1.8 U
Beta-BHC	UG/KG	2.4	1%	200	0	1	178	1.9 U	1.9 U	1.9 U	1.8 U
Delta-BHC	UG/KG	0	0%	300	0	0	178	1.9 U	1.9 U	1.9 U	1.8 U
Dieldrin	UG/KG	0	0%	44	0	0	178	3.6 U	3.7 U	3.6 U	3.5 U
Endosulfan I	UG/KG	16	1%	900	0	1	178	1.9 U	1.9 U	1.9 U	1.8 U
Endosulfan II	UG/KG	0	0%	900	0	0	178	3.6 U	3.7 U	3.6 U	3.5 U
Endosulfan sulfate	UG/KG	6.2	1%	1000	0	1	178	3.6 U	3.7 U	3.6 U	3.5 U
Endrin	UG/KG	16	2%	100	0	3	178	3.6 U	3.7 U	3.6 U	3.5 U
Endrin aldehyde	UG/KG	4.9	1%		0	2	178	3.6 U	3.7 U	3.6 U	3.5 U
Endrin ketone	UG/KG	38	2%		0	4	178	3.6 U	3.7 U	3.6 U	3.5 U
Gamma-BHC/Lindane	UG/KG	0	0%	60	0	0	178	1.9 U	1.9 U	1.9 U	1.8 U
Gamma-Chlordane	UG/KG	24	8%	540	0	14	178	1.9 U	1.9 U	1.9 U	1.8 U
Heptachlor	UG/KG	0	0%	100	0	0	178	1.9 U	1.9 U	1.9 U	1.8 U
Heptachlor epoxide	UG/KG	3	1%	20	0	2	178	1.9 U	1.9 U	1.9 U	1.8 U
Methoxychlor	UG/KG	0	0%		0	0	178	19 U	19 U	19 U	18 U
Toxaphene	UG/KG	0	0%		0	0	178	190 U	190 U	190 U	180 U
Aroclor-1016	UG/KG	0	0%		0	0	178	37 U	37 U	37 U	35 U
Aroclor-1221	UG/KG	0	0%		0	0	178	37 U	37 U	37 U	35 U
Aroclor-1232	UG/KG	0	0%		0	0	178	37 U	37 U	37 U	35 U
Aroclor-1242	UG/KG	0	0%		0	0	178	37 U	37 U	37 U	35 U
Aroclor-1248	UG/KG	0	0%		0	0	178	37 U	37 U	37 U	35 U
Aroclor-1254	UG/KG	0	0%	10000	0	0	178	37 U	37 U	37 U	35 U
Aroclor-1260	UG/KG	79	1%	10000	0	2	178	37 U	37 U	37 U	35 U
Metals											
Aluminum	MG/KG	18300	100%	19300	0	178	178	11400	11400	12400	11200
Antimony	MG/KG	424	58%	5.9	5	104	178	1.1 J	1.5 J	1.5 J	1.4 J
Arsenic	MG/KG	32.2	100%	8.2	7	178	178	6.4	5.6	7.8	6.2
Barium	MG/KG	304	100%	300	1	178	178	59.6	83	92.5	81.2
Beryllium	MG/KG	2.6	99%	1.1	2	176	178	0.57	0.6	0.68	0.56
Cadmium	MG/KG	3.2	86%	2.3	2	153	178	0.26 J	0.17 J	0.26 J	0.19 J
Calcium	MG/KG	214000	100%	121000	1	178	178	11800	9390	3140	2540
Chromium	MG/KG	39.3	100%	29.6	2	178	178	18.3	17.7	19.5	17.4
Cobalt	MG/KG	47.8	100%	30	2	178	178	8.3 J	7.9 J	12.6 J	9.1 J
Copper	MG/KG	305	100%	33	19	178	178	19.9	17.7	30.2	25.1
Cyanide	MG/KG	0	0%	0.35	0	0	9				
Iron	MG/KG	64000	100%	36500	1	178	178	23800	22300	26200	23200
Lead	MG/KG	164	100%	24.8	75	178	178	13.1	12.8	17.1	11.7
Magnesium	MG/KG	30200	100%	21500	3	178	178	5280	5090	4520	4390
Manganese	MG/KG	1290	100%	1060	3	178	178	261	265	540	543
Mercury	MG/KG	0.95	95%	0.1	37	169	178	0.06	0.05	0.05	0.02 J
Nickel	MG/KG	88.3	100%	49	3	178	178	27.6	28.5	35.5	27.9
Potassium	MG/KG	2290	100%	2380	0	178	178	833	838	962	947
Selenium	MG/KG	1.5	9%	2	0	16	178	0.36 UJ	0.45 UJ	0.44 UJ	0.43 UJ
Silver	MG/KG	2.9	49%	0.75	62	87	178	2	2.1	2.5	2.3
Sodium	MG/KG	4060	99%	172	86	177	178	164	239	95.7	96

**Table A-2A
SURFACE SOIL SAMPLE RESULTS (0-2 ft.)
SEAD-59
SEAD-59 and SEAD-71 Phase II RI Report
Seneca Army Depot Activity**

				SEAD-59	SEAD-59	SEAD-59	SEAD-59				
Facility				CL-59-OTHERB-F01	CL-59-OTHERB-WE1	CL-59-OTHERB-WN1	CL-59-OTHERB-WS1				
Location ID				SOIL	SOIL	SOIL	SOIL				
Maxtrix				CL-59-OTHERB-F01	CL-59-OTHERB-WE1	CL-59-OTHERB-WN1	CL-59-OTHERB-WS1				
Sample ID				0	0	0	0				
Sample Depth to Top of Sample ⁽¹⁾				0	0	0	0				
Sample Depth to Bottom of Sample ⁽¹⁾				5/6/2004	5/6/2004	5/6/2004	5/6/2004				
Sample Date				SA	SA	SA	SA				
QC Code				ENSR IRM	ENSR IRM	ENSR IRM	ENSR IRM				
Study ID				1	1	1	1				
Sample Round											
Parameter	Units	Maximum Value	Frequency of Detection	NYSDEC TAGM 4046 ⁽²⁾	Number of Exceedances	Number of Detects	Number of Analyses ⁽³⁾	Value (Q)	Value (Q)	Value (Q)	Value (Q)
Thallium	MG/KG	1.8	29%	0.7	24	51	178	0.18 U	0.4 J	0.22 U	0.21 U
Vanadium	MG/KG	28.5	100%	150	0	178	178	18.3	18.2	21.5	19.6
Zinc	MG/KG	341	100%	110	19	178	178	125	54.8	74.4	57.4

Note(s):

- (1) - Historical sample depths are presented (I.e. prior to 2002 TCRA)
- (2) - NYSDEC Technical and Administrative Guidance Memorandum (TAGM) HWR-94-4046, Revised January 24, 1994
- (3) - Sample/Duplicate pair are presented as individual samples in this table. Statistical information used Sample Duplicate pairs as a single entity and averaged result values were used in risk assessment analysis.

U = compound was not detected

J = the reported value is an estimated concentration

UJ = the compound was not detected; the associated reporting limit is approximate

R = the data was rejected in the data validating process

NJ = compound was "tentatively identified" and the associated numerical value is approximate

Table A-2A
SURFACE SOIL SAMPLE RESULTS (0-2 ft.)
SEAD-59
SEAD-59 and SEAD-71 Phase II RI Report
Seneca Army Depot Activity

Facility	SEAD-59	SEAD-59	SEAD-59	SEAD-59							
Location ID	CL-59-OTHERB-WW1	CL-59-OTHERC-F01	CL-59-OTHERC-WE2	CL-59-OTHERC-WS1							
Maxtrix	SOIL	SOIL	SOIL	SOIL							
Sample ID	CL-59-OTHERB-WW1	CL-59-OTHERC-F01	CL-59-OTHERC-WE2	CL-59-OTHERC-WS1							
Sample Depth to Top of Sample ⁽¹⁾	0	0	0	0							
Sample Depth to Bottom of Sample ⁽¹⁾	0	0	0	0							
Sample Date	5/6/2004	5/6/2004	5/6/2004	5/6/2004							
QC Code	SA	SA	SA	SA							
Study ID	ENSR IRM	ENSR IRM	ENSR IRM	ENSR IRM							
Sample Round	1	1	1	1							
Parameter	Units	Maximum Value	Frequency of Detection	NYSDEC TAGM 4046 ⁽²⁾	Number of Exceedances	Number of Detects	Number of Analyses ⁽³⁾	Value (Q)	Value (Q)	Value (Q)	Value (Q)
Volatile Organics											
1,1,1-Trichloroethane	UG/KG	0	0%	800	0	0	177	5 U	5.4 U	5 U	6 U
1,1,2,2-Tetrachloroethane	UG/KG	0	0%	600	0	0	169	5 R	5.4 U	5 UJ	6 U
1,1,2-Trichloro-1,2,2-Trifluoroethane	UG/KG	0	0%		0	0	168	5 U	5.4 U	5 U	6 U
1,1,2-Trichloroethane	UG/KG	0	0%		0	0	107	5 U		5 U	
1,1-Dichloroethane	UG/KG	0	0%	200	0	0	177	5 U	5.4 U	5 U	6 U
1,1-Dichloroethene	UG/KG	8	2%	400	0	3	177	5 U	5.4 U	5 U	6 U
1,2,3-Trichloropropane	UG/KG	0	0%		0	0	70		5.4 U		6 U
1,2,4-Trichlorobenzene	UG/KG	0	0%	3400	0	0	161	5 R	5.4 U	5 UJ	6 U
1,2-Dibromo-3-chloropropane	UG/KG	0	0%		0	0	91	5 R		5 UJ	
1,2-Dibromoethane	UG/KG	0	0%		0	0	98	5 U		5 U	
1,2-Dichlorobenzene	UG/KG	0	0%	7900	0	0	161	5 R	5.4 U	5 UJ	6 U
1,2-Dichloroethane	UG/KG	0	0%	100	0	0	177	5 U	5.4 U	5 U	6 U
1,2-Dichloroethene (total)	UG/KG	0	0%		0	0	9				
1,2-Dichloropropane	UG/KG	0	0%		0	0	107	5 U		5 U	
1,3-Dichlorobenzene	UG/KG	0	0%	1600	0	0	161	5 R	5.4 U	5 UJ	6 U
1,3-Dichloropropane	UG/KG	0	0%		0	0	70		5.4 U		6 U
1,4-Dichlorobenzene	UG/KG	0	0%	8500	0	0	161	5 R	5.4 U	5 UJ	6 U
Acetone	UG/KG	550	27%	200	2	47	177	24 U	22 U	16 J	24 U
Benzene	UG/KG	3	4%	60	0	7	177	1 J	5.4 U	5 U	6 U
Bromodichloromethane	UG/KG	0	0%		0	0	107	5 U		5 U	
Bromoform	UG/KG	0	0%		0	0	107	5 UJ		5 U	
Carbon disulfide	UG/KG	4	3%	2700	0	6	177	5 U	5.4 U	5 U	6 U
Carbon tetrachloride	UG/KG	0	0%	600	0	0	177	5 U	5.4 U	5 U	6 U
Chlorobenzene	UG/KG	0	0%	1700	0	0	177	5 U	5.4 U	5 U	6 U
Chlorodibromomethane	UG/KG	0	0%		0	0	177	5 U	5.4 U	5 U	6 U
Chloroethane	UG/KG	0	0%	1900	0	0	177	5 U	11 U	5 U	12 U
Chloroform	UG/KG	0	0%	300	0	0	177	5 U	5.4 U	5 U	6 U
Cis-1,2-Dichloroethene	UG/KG	0	0%		0	0	98	5 U		5 U	
Cis-1,3-Dichloropropene	UG/KG	0	0%		0	0	107	5 U		5 U	
Cyclohexane	UG/KG	3	8%		0	8	98	3 J		5 U	
Dichlorodifluoromethane	UG/KG	0	0%		0	0	98	5 U		5 U	
Ethyl benzene	UG/KG	4.6	1%	5500	0	2	177	5 U	5.4 U	5 U	6 U
Isopropylbenzene	UG/KG	0	0%		0	0	98	5 U		5 U	
Meta/Para Xylene	UG/KG	9.4	4%		0	3	70		5.4 U		6 U
Methyl Acetate	UG/KG	2	3%		0	3	98	1 J		5 U	
Methyl Tertbutyl Ether	UG/KG	0	0%		0	0	98	5 U		5 U	
Methyl bromide	UG/KG	0	0%		0	0	107	5 U		5 U	
Methyl butyl ketone	UG/KG	0	0%		0	0	107	5 U		5 U	
Methyl chloride	UG/KG	0	0%		0	0	107	5 U		5 U	
Methyl cyclohexane	UG/KG	5	10%		0	10	98	5 J		5 U	
Methyl ethyl ketone	UG/KG	190	12%	300	0	22	177	2 J	11 U	5 U	12 U
Methyl isobutyl ketone	UG/KG	1.9	1%	1000	0	1	177	5 U	11 U	5 U	1.9 J
Methylene chloride	UG/KG	4.9	20%	100	0	36	178	5 U	5.4 U	5 U	6 U
Ortho Xylene	UG/KG	5.05	4%		0	3	70		5.4 U		6 U

Table A-2A
SURFACE SOIL SAMPLE RESULTS (0-2 ft.)
SEAD-59
SEAD-59 and SEAD-71 Phase II RI Report
Seneca Army Depot Activity

Facility	SEAD-59								SEAD-59	SEAD-59	SEAD-59	SEAD-59
Location ID	CL-59-OTHERB-WW1								CL-59-OTHERC-F01	CL-59-OTHERC-F01	CL-59-OTHERC-F01	CL-59-OTHERC-F01
Maxtrix	SOIL								SOIL	SOIL	SOIL	SOIL
Sample ID	CL-59-OTHERB-WW1								CL-59-OTHERC-F01	CL-59-OTHERC-F01	CL-59-OTHERC-F01	CL-59-OTHERC-F01
Sample Depth to Top of Sample ⁽¹⁾	0								0	0	0	0
Sample Depth to Bottom of Sample ⁽¹⁾	0								0	0	0	0
Sample Date	5/6/2004								5/6/2004	5/6/2004	5/6/2004	5/6/2004
QC Code	SA								SA	SA	SA	SA
Study ID	ENSR IRM								ENSR IRM	ENSR IRM	ENSR IRM	ENSR IRM
Sample Round	1								1	1	1	1
Parameter	Units	Maximum Value	Frequency of Detection	NYSDEC TAGM 4046 ⁽²⁾	Number of Exceedances	Number of Detects	Number of Analyses ⁽³⁾	Value (Q)	Value (Q)	Value (Q)	Value (Q)	
Styrene	UG/KG	0	0%		0	0	107	5 U		5 U		
Tetrachloroethene	UG/KG	6.4	3%	1400	0	5	177	5 U	5.4 U	5 U	6 U	
Toluene	UG/KG	8	8%	1500	0	14	177	3 J	5.4 U	5 U	6 U	
Total BTEX	MG/KG	3.25	67%		0	2	3					
Total Xylenes	UG/KG	3	7%	1200	0	7	102	2 J		5 UJ		
Trans-1,2-Dichloroethene	UG/KG	0	0%	300	0	0	168	5 U	5.4 U	5 U	6 U	
Trans-1,3-Dichloropropene	UG/KG	0	0%		0	0	107	5 U		5 U		
Trichloroethene	UG/KG	4.5	5%	700	0	8	177	5 U	5.4 U	5 U	6 U	
Trichlorofluoromethane	UG/KG	6	1%		0	1	98	5 U		5 U		
Vinyl chloride	UG/KG	0	0%	200	0	0	177	5 U	11 U	5 U	12 U	
Semivolatile Organics												
1,1'-Biphenyl	UG/KG	254.5	2%		0	2	99	350 U		360 U		
1,2,4-Trichlorobenzene	UG/KG	0	0%	3400	0	0	9					
1,2-Dichlorobenzene	UG/KG	0	0%	7900	0	0	9					
1,3-Dichlorobenzene	UG/KG	0	0%	1600	0	0	9					
1,4-Dichlorobenzene	UG/KG	0	0%	8500	0	0	9					
2,2'-oxybis(1-Chloropropane)	UG/KG	0	0%		0	0	105	350 U		360 U		
2,4,5-Trichlorophenol	UG/KG	0	0%	100	0	0	178	890 U	360 U	910 U	400 U	
2,4,6-Trichlorophenol	UG/KG	0	0%		0	0	178	350 U	360 U	360 U	400 U	
2,4-Dichlorophenol	UG/KG	0	0%	400	0	0	178	350 U	360 U	360 U	400 U	
2,4-Dimethylphenol	UG/KG	0	0%		0	0	108	350 U		360 U		
2,4-Dinitrophenol	UG/KG	0	0%	200	0	0	178	890 U	1800 U	910 U	2000 U	
2,4-Dinitrotoluene	UG/KG	0	0%		0	0	178	350 U	360 U	360 U	400 U	
2,6-Dinitrotoluene	UG/KG	0	0%	1000	0	0	178	350 U	360 U	360 U	400 U	
2-Chloronaphthalene	UG/KG	0	0%		0	0	108	350 U		360 U		
2-Chlorophenol	UG/KG	0	0%	800	0	0	178	350 U	360 U	360 U	400 U	
2-Methylnaphthalene	UG/KG	1295	19%	36400	0	34	178	350 U	360 U	360 U	400 U	
2-Methylphenol	UG/KG	0	0%	100	0	0	178	350 U	360 U	360 U	400 U	
2-Nitroaniline	UG/KG	0	0%	430	0	0	178	890 U	1800 U	910 U	2000 U	
2-Nitrophenol	UG/KG	0	0%	330	0	0	178	350 U	360 U	360 U	400 U	
3,3'-Dichlorobenzidine	UG/KG	0	0%		0	0	178	350 U	360 U	360 U	400 U	
3-Nitroaniline	UG/KG	0	0%	500	0	0	178	890 U	1800 U	910 U	2000 U	
4,6-Dinitro-2-methylphenol	UG/KG	0	0%		0	0	108	890 U		910 U		
4-Bromophenyl phenyl ether	UG/KG	0	0%		0	0	108	350 U		360 U		
4-Chloro-3-methylphenol	UG/KG	0	0%	240	0	0	178	350 U	360 U	360 U	400 U	
4-Chloroaniline	UG/KG	1200	1%	220	1	2	178	350 U	360 U	360 U	400 U	
4-Chlorophenyl phenyl ether	UG/KG	0	0%		0	0	108	350 U		360 U		
4-Methylphenol	UG/KG	150	3%	900	0	5	178	350 U	360 U	360 U	400 U	
4-Nitroaniline	UG/KG	0	0%		0	0	108	890 U		910 U		
4-Nitrophenol	UG/KG	0	0%	100	0	0	178	890 U	1800 U	910 U	2000 U	
Acenaphthene	UG/KG	2680	24%	50000	0	42	178	350 U	360 U	360 U	400 U	
Acenaphthylene	UG/KG	1700	37%	41000	0	66	178	350 U	360 U	360 U	400 U	
Acetophenone	UG/KG	0	0%		0	0	99	350 U		360 U		
Aniline	UG/KG	0	0%		0	0	70		360 U		400 U	
Anthracene	UG/KG	4395	43%	50000	0	77	178	350 U	360 U	360 U	400 U	

Table A-2A
SURFACE SOIL SAMPLE RESULTS (0-2 ft.)
SEAD-59
SEAD-59 and SEAD-71 Phase II RI Report
Seneca Army Depot Activity

Facility	SEAD-59								SEAD-59	SEAD-59	SEAD-59	SEAD-59
Location ID	CL-59-OTHERB-WW1								CL-59-OTHERC-F01	CL-59-OTHERC-F01	CL-59-OTHERC-F01	CL-59-OTHERC-F01
Matrix	SOIL								SOIL	SOIL	SOIL	SOIL
Sample ID	CL-59-OTHERB-WW1								CL-59-OTHERC-F01	CL-59-OTHERC-F01	CL-59-OTHERC-F01	CL-59-OTHERC-F01
Sample Depth to Top of Sample ⁽¹⁾	0								0	0	0	0
Sample Depth to Bottom of Sample ⁽¹⁾	0								0	0	0	0
Sample Date	5/6/2004								5/6/2004	5/6/2004	5/6/2004	5/6/2004
QC Code	SA								SA	SA	SA	SA
Study ID	ENSR IRM								ENSR IRM	ENSR IRM	ENSR IRM	ENSR IRM
Sample Round	1								1	1	1	1
Parameter	Units	Maximum Value	Frequency of Detection	NYSDEC TAGM 4046 ⁽²⁾	Number of Exceedances	Number of Detects	Number of Analyses ⁽³⁾	Value (Q)	Value (Q)	Value (Q)	Value (Q)	
Atrazine	UG/KG	120	1%		0	1	99	350 U		360 U		
Benzaldehyde	UG/KG	50	1%		0	1	99	350 U		360 U		
Benzo(a)anthracene	UG/KG	8900	51%	224	72	90	178	100 J	360 U	95 J	69 J	
Benzo(a)pyrene	UG/KG	8050	51%	61	84	91	178	120 J	360 U	97 J	61 NJ	
Benzo(b)fluoranthene	UG/KG	6800	52%	1100	40	92	178	150 J	360 U	140 J	67 J	
Benzo(ghi)perylene	UG/KG	5200	46%	50000	0	82	178	350 U	360 U	360 U	400 U	
Benzo(k)fluoranthene	UG/KG	7350	49%	1100	35	88	178	100 J	360 U	85 NJ	400 U	
Benzoic Acid	UG/KG	0	0%	2700	0	0	70		1800 U		2000 U	
Bis(2-Chloroethoxy)methane	UG/KG	0	0%		0	0	108	350 U		360 U		
Bis(2-Chloroethyl)ether	UG/KG	0	0%		0	0	108	350 U		360 U		
Bis(2-Chloroisopropyl)ether	UG/KG	0	0%		0	0	3					
Bis(2-Ethylhexyl)phthalate	UG/KG	990	19%	50000	0	34	178	350 U	360 U	360 U	400 U	
Butylbenzylphthalate	UG/KG	0	0%	50000	0	0	178	350 U	360 U	360 U	400 U	
Caprolactam	UG/KG	0	0%		0	0	99	350 U		360 U		
Carbazole	UG/KG	755	19%		0	20	108	350 U		360 U		
Chrysene	UG/KG	8900	51%	400	62	91	178	120 J	360 U	110 J	89 J	
Di-n-butylphthalate	UG/KG	965	2%	8100	0	4	178	350 U	360 U	360 U	400 U	
Di-n-octylphthalate	UG/KG	0	0%	50000	0	0	178	350 U	360 U	360 U	400 U	
Dibenz(a,h)anthracene	UG/KG	1665	38%	14	67	68	178	350 U	360 U	360 U	400 U	
Dibenzofuran	UG/KG	2350	16%	6200	0	28	178	350 U	360 U	360 U	400 U	
Diethyl phthalate	UG/KG	10	1%	7100	0	1	178	350 U	360 U	360 U	400 U	
Dimethylphthalate	UG/KG	0	0%	2000	0	0	178	350 U	360 U	360 U	400 U	
Fluoranthene	UG/KG	23500	54%	50000	0	97	178	200 J	360 U	180 J	89 J	
Fluorene	UG/KG	2640	28%	50000	0	49	178	350 U	360 U	360 U	400 U	
Hexachlorobenzene	UG/KG	0	0%	410	0	0	178	350 U	360 U	360 U	400 U	
Hexachlorobutadiene	UG/KG	0	0%		0	0	178	350 U	360 U	360 U	400 U	
Hexachlorocyclopentadiene	UG/KG	0	0%		0	0	108	350 U		360 U		
Hexachloroethane	UG/KG	0	0%		0	0	178	350 U	360 U	360 U	400 U	
Indeno(1,2,3-cd)pyrene	UG/KG	4950	47%	3200	2	84	178	350 U	360 U	360 U	400 U	
Isophorone	UG/KG	0	0%	4400	0	0	178	350 U	360 U	360 U	400 U	
N-Nitrosodiphenylamine	UG/KG	100	1%		0	1	108	350 U		360 U		
N-Nitrosodipropylamine	UG/KG	0	0%		0	0	108	350 U		360 U		
Naphthalene	UG/KG	1800	19%	13000	0	34	178	350 U	360 U	360 U	400 U	
Nitrobenzene	UG/KG	0	0%	200	0	0	178	350 U	360 U	360 U	400 U	
Pentachlorophenol	UG/KG	0	0%	1000	0	0	178	890 U	1800 U	910 U	2000 U	
Phenanthrene	UG/KG	21300	51%	50000	0	90	178	84 J	360 U	73 J	400 U	
Phenol	UG/KG	0	0%	30	0	0	178	350 U	360 U	360 U	400 U	
Pyrene	UG/KG	19200	55%	50000	0	98	178	210 J	360 U	170 J	98 J	
Pyridine	UG/KG	0	0%		0	0	100		1800 U		2000 U	
Total Unknown PAHs as SV	MG/KG	25	100%		0	3	3					
Pesticides/PCBs												
4,4'-DDD	UG/KG	740	28%	2900	0	49	178	3.5 U	18 U	13	20 U	
4,4'-DDE	UG/KG	2600	37%	2100	1	65	178	6 J	18 U	27	22 J	
4,4'-DDT	UG/KG	3700	33%	2100	1	59	178	3.5 U	18 U	59	24	
Aldrin	UG/KG	1.2	1%	41	0	1	178	1.8 U	9.2 U	1.8 U	10 U	

Table A-2A
SURFACE SOIL SAMPLE RESULTS (0-2 ft.)
SEAD-59
SEAD-59 and SEAD-71 Phase II RI Report
Seneca Army Depot Activity

Facility	SEAD-59				SEAD-59				SEAD-59				SEAD-59			
Location ID	CL-59-OTHERB-WW1				CL-59-OTHERC-F01				CL-59-OTHERC-F01				CL-59-OTHERC-F01			
Matrix	SOIL				SOIL				SOIL				SOIL			
Sample ID	CL-59-OTHERB-WW1				CL-59-OTHERC-F01				CL-59-OTHERC-F01				CL-59-OTHERC-F01			
Sample Depth to Top of Sample ⁽¹⁾	0				0				0				0			
Sample Depth to Bottom of Sample ⁽¹⁾	0				0				0				0			
Sample Date	5/6/2004				5/6/2004				5/6/2004				5/6/2004			
QC Code	SA				SA				SA				SA			
Study ID	ENSR IRM				ENSR IRM				ENSR IRM				ENSR IRM			
Sample Round	1				1				1				1			
Parameter	Units	Maximum Value	Frequency of Detection	NYSDEC TAGM 4046 ⁽²⁾	Number of Exceedances	Number of Detects	Number of Analyses ⁽³⁾	Value (Q)	Value (Q)	Value (Q)	Value (Q)	Value (Q)	Value (Q)	Value (Q)	Value (Q)	
Alpha-BHC	UG/KG	0	0%	110	0	0	178	1.8 U	9.2 U	1.8 U	10 U	10 U	10 U	10 U		
Alpha-Chlordane	UG/KG	34	4%		0	7	178	1.8 U	9.2 U	1.8 U	10 U	10 U	10 U	10 U		
Beta-BHC	UG/KG	2.4	1%	200	0	1	178	1.8 U	9.2 U	1.8 U	10 U	10 U	10 U	10 U		
Delta-BHC	UG/KG	0	0%	300	0	0	178	1.8 U	9.2 U	1.8 U	10 U	10 U	10 U	10 U		
Dieldrin	UG/KG	0	0%	44	0	0	178	3.5 U	18 U	3.6 U	20 U	20 U	20 U	20 U		
Endosulfan I	UG/KG	16	1%	900	0	1	178	1.8 U	9.2 U	1.8 U	10 U	10 U	10 U	10 U		
Endosulfan II	UG/KG	0	0%	900	0	0	178	3.5 U	18 U	3.6 U	20 U	20 U	20 U	20 U		
Endosulfan sulfate	UG/KG	6.2	1%	1000	0	1	178	3.5 U	18 U	6.2 J	20 U	20 U	20 U	20 U		
Endrin	UG/KG	16	2%	100	0	3	178	3.5 U	18 U	3.6 U	20 U	20 U	20 U	20 U		
Endrin aldehyde	UG/KG	4.9	1%		0	2	178	3.5 U	18 U	3.6 U	20 U	20 U	20 U	20 U		
Endrin ketone	UG/KG	38	2%		0	4	178	3.5 U	18 U	3.6 U	20 U	20 U	20 U	20 U		
Gamma-BHC/Lindane	UG/KG	0	0%	60	0	0	178	1.8 U	9.2 U	1.8 U	10 U	10 U	10 U	10 U		
Gamma-Chlordane	UG/KG	24	8%	540	0	14	178	1.8 U	9.2 U	1.8 U	10 U	10 U	10 U	10 U		
Heptachlor	UG/KG	0	0%	100	0	0	178	1.8 U	9.2 U	1.8 U	10 U	10 U	10 U	10 U		
Heptachlor epoxide	UG/KG	3	1%	20	0	2	178	1.8 U	9.2 U	1.8 U	10 U	10 U	10 U	10 U		
Methoxychlor	UG/KG	0	0%		0	0	178	18 U	92 U	18 U	100 U	100 U	100 U	100 U		
Toxaphene	UG/KG	0	0%		0	0	178	180 U	180 U	180 U	200 U	200 U	200 U	200 U		
Aroclor-1016	UG/KG	0	0%		0	0	178	36 U	36 U	36 U	40 U	40 U	40 U	40 U		
Aroclor-1221	UG/KG	0	0%		0	0	178	36 U	36 U	36 U	40 U	40 U	40 U	40 U		
Aroclor-1232	UG/KG	0	0%		0	0	178	36 U	36 U	36 U	40 U	40 U	40 U	40 U		
Aroclor-1242	UG/KG	0	0%		0	0	178	36 U	36 U	36 U	40 U	40 U	40 U	40 U		
Aroclor-1248	UG/KG	0	0%		0	0	178	36 U	36 U	36 U	40 U	40 U	40 U	40 U		
Aroclor-1254	UG/KG	0	0%	10000	0	0	178	36 U	36 U	36 U	40 U	40 U	40 U	40 U		
Aroclor-1260	UG/KG	79	1%	10000	0	2	178	36 U	36 U	79 NJ	40 U	40 U	40 U	40 U		
Metals																
Aluminum	MG/KG	18300	100%	19300	0	178	178	10700	10800	14700 J	13800	13800	13800	13800		
Antimony	MG/KG	424	58%	5.9	5	104	178	1.4 J	3.2 UJ	2.4 J	3.6 UJ	3.6 UJ	3.6 UJ	3.6 UJ		
Arsenic	MG/KG	32.2	100%	8.2	7	178	178	5.9	3.7	7 J	9.3	9.3	9.3	9.3		
Barium	MG/KG	304	100%	300	1	178	178	64.4	82.9	99.7 J	140	140	140	140		
Beryllium	MG/KG	2.6	99%	1.1	2	176	178	0.54	0.23	0.73	0.45	0.45	0.45	0.45		
Cadmium	MG/KG	3.2	86%	2.3	2	153	178	0.27 J	0.27 U	0.39	0.64	0.64	0.64	0.64		
Calcium	MG/KG	214000	100%	121000	1	178	178	25600	17200	6460	7470	7470	7470	7470		
Chromium	MG/KG	39.3	100%	29.6	2	178	178	16	15.9	20.7 J	20.4	20.4	20.4	20.4		
Cobalt	MG/KG	47.8	100%	30	2	178	178	7.2 J	6	10.2 J	18.4	18.4	18.4	18.4		
Copper	MG/KG	305	100%	33	19	178	178	18.8	17.6	22.8 J	29.6	29.6	29.6	29.6		
Cyanide	MG/KG	0	0%	0.35	0	0	9									
Iron	MG/KG	64000	100%	36500	1	178	178	20900	19300 J	23900	27800 J	27800 J	27800 J	27800 J		
Lead	MG/KG	164	100%	24.8	75	178	178	15.9	20.8 J	40 J	73.7 J	73.7 J	73.7 J	73.7 J		
Magnesium	MG/KG	30200	100%	21500	3	178	178	6540	5170	4240 J	4850	4850	4850	4850		
Manganese	MG/KG	1290	100%	1060	3	178	178	340	267 J	453 J	1240 J	1240 J	1240 J	1240 J		
Mercury	MG/KG	0.95	95%	0.1	37	169	178	0.06	0.11	0.14	0.17	0.17	0.17	0.17		
Nickel	MG/KG	88.3	100%	49	3	178	178	23.1	21.8	28.6 J	39.2	39.2	39.2	39.2		
Potassium	MG/KG	2290	100%	2380	0	178	178	793	1090	1240 J	1300	1300	1300	1300		
Selenium	MG/KG	1.5	9%	2	0	16	178	0.39 UJ	0.54 U	0.44 U	0.59 U	0.59 U	0.59 U	0.59 U		
Silver	MG/KG	2.9	49%	0.75	62	87	178	1.7	0.54 U	1.4	0.59 U	0.59 U	0.59 U	0.59 U		
Sodium	MG/KG	4060	99%	172	86	177	178	109	193	89.9	63	63	63	63		

**Table A-2A
SURFACE SOIL SAMPLE RESULTS (0-2 ft.)
SEAD-59
SEAD-59 and SEAD-71 Phase II RI Report
Seneca Army Depot Activity**

				SEAD-59	SEAD-59	SEAD-59	SEAD-59				
Facility				CL-59-OTHERB-WW1	CL-59-OTHERC-F01	CL-59-OTHERC-WE2	CL-59-OTHERC-WS1				
Location ID				SOIL	SOIL	SOIL	SOIL				
Maxtrix				CL-59-OTHERB-WW1	CL-59-OTHERC-F01	CL-59-OTHERC-WE2	CL-59-OTHERC-WS1				
Sample ID											
Sample Depth to Top of Sample ⁽¹⁾				0	0	0	0				
Sample Depth to Bottom of Sample ⁽¹⁾				0	0	0	0				
Sample Date				5/6/2004	5/6/2004	5/6/2004	5/6/2004				
QC Code				SA	SA	SA	SA				
Study ID				ENSR IRM	ENSR IRM	ENSR IRM	ENSR IRM				
Sample Round				1	1	1	1				
Parameter	Units	Maximum Value	Frequency of Detection	NYSDEC TAGM 4046 ⁽²⁾	Number of Exceedances	Number of Detects	Number of Analyses ⁽³⁾	Value (Q)	Value (Q)	Value (Q)	Value (Q)
Thallium	MG/KG	1.8	29%	0.7	24	51	178	0.19 U	0.54 U	0.22 U	1.1 J
Vanadium	MG/KG	28.5	100%	150	0	178	178	16.5	19.9	22.4 J	25.8 J
Zinc	MG/KG	341	100%	110	19	178	178	68.6	90.4 J	228 J	100 J

Note(s):
 (1) - Historical sample depths are presented (I.e. prior to 2002 TCRA)
 (2) - NYSDEC Technical and Administrative Guidance Memorandum (TAGM) HWR-94-4046, Revised January 24, 1994
 (3) - Sample/Duplicate pair are presented as individual samples in this table. Statistical information used Sample Duplicate pairs as a single entity and averaged result values were used in risk assessment analysis.

U = compound was not detected
 J = the reported value is an estimated concentration
 UJ = the compound was not detected; the associated reporting limit is approximate
 R = the data was rejected in the data validating process
 NJ = compound was "tentatively identified" and the associated numerical value is approximate

**Table A-2A
SURFACE SOIL SAMPLE RESULTS (0-2 ft.)
SEAD-59
SEAD-59 and SEAD-71 Phase II RI Report
Seneca Army Depot Activity**

Facility	SEAD-59	SEAD-59	SEAD-59	SEAD-59	SEAD-59
Location ID	CL-59-OTHERC-WW1	SB59-2	SB59-3	SB59-4	SB59-4
Maxitrix	SOIL	SOIL	SOIL	SOIL	SOIL
Sample ID	CL-59-OTHERC-WW1	SB59-2-02	SB59-3-04	SB59-4-05	SB59-4-10
Sample Depth to Top of Sample ⁽¹⁾	0	2	6	8	10
Sample Depth to Bottom of Sample ⁽¹⁾	0	4	8	10	20
Sample Date	5/6/2004	5/26/1994	5/25/1994	5/25/1994	5/25/1994
QC Code	SA	SA	SA	SA	SA
Study ID	ENSR IRM	ESI	ESI	ESI	ESI
Sample Round	1				

Parameter	Units	Maximum	Frequency of	NYSDEC	Number of	Number of	Number of	Value (Q)	Value (Q)	Value (Q)	Value (Q)	Value (Q)
		Value	Detection	TAGM 4046 ⁽²⁾	Exceedances	Detects	Analyses ⁽³⁾					
Volatiles Organics												
1,1,1-Trichloroethane	UG/KG	0	0%	800	0	0	177	5.6 U	12 U	11 U	18 U	11 U
1,1,2,2-Tetrachloroethane	UG/KG	0	0%	600	0	0	169	5.6 U	12 U	11 U	18 U	11 U
1,1,2-Trichloro-1,2,2-Trifluoroethane	UG/KG	0	0%		0	0	168	5.6 U				
1,1,2-Trichloroethane	UG/KG	0	0%		0	0	107		12 U	11 U	18 U	11 U
1,1-Dichloroethane	UG/KG	0	0%	200	0	0	177	5.6 U	12 U	11 U	18 U	11 U
1,1-Dichloroethane	UG/KG	8	2%	400	0	3	177	5.6 U	12 U	11 U	18 U	11 U
1,2,3-Trichloropropane	UG/KG	0	0%		0	0	70	5.6 U				
1,2,4-Trichlorobenzene	UG/KG	0	0%	3400	0	0	161	5.6 U				
1,2-Dibromo-3-chloropropane	UG/KG	0	0%		0	0	91					
1,2-Dibromoethane	UG/KG	0	0%		0	0	98					
1,2-Dichlorobenzene	UG/KG	0	0%	7900	0	0	161	5.6 U				
1,2-Dichloroethane	UG/KG	0	0%	100	0	0	177	5.6 U	12 U	11 U	18 U	11 U
1,2-Dichloroethene (total)	UG/KG	0	0%		0	0	9		12 U	11 U	18 U	11 U
1,2-Dichloropropane	UG/KG	0	0%		0	0	107		12 U	11 U	18 U	11 U
1,3-Dichlorobenzene	UG/KG	0	0%	1600	0	0	161	5.6 U				
1,3-Dichloropropane	UG/KG	0	0%		0	0	70	5.6 U				
1,4-Dichlorobenzene	UG/KG	0	0%	8500	0	0	161	5.6 U				
Acetone	UG/KG	550	27%	200	2	47	177	22 U	45 U	11 U	18 U	11 U
Benzene	UG/KG	3	4%	60	0	7	177	5.6 U	12 U	11 U	18 U	11 U
Bromodichloromethane	UG/KG	0	0%		0	0	107		12 U	11 U	18 U	11 U
Bromoform	UG/KG	0	0%		0	0	107		12 U	11 U	18 U	11 U
Carbon disulfide	UG/KG	4	3%	2700	0	6	177	5.6 U	12 U	11 U	4 J	11 U
Carbon tetrachloride	UG/KG	0	0%	600	0	0	177	5.6 U	12 U	11 U	18 U	11 U
Chlorobenzene	UG/KG	0	0%	1700	0	0	177	5.6 U	12 U	11 U	18 U	11 U
Chlorodibromomethane	UG/KG	0	0%		0	0	177	5.6 U	12 U	11 U	18 U	11 U
Chloroethane	UG/KG	0	0%	1900	0	0	177	11 U	12 U	11 U	18 U	11 U
Chloroform	UG/KG	0	0%	300	0	0	177	5.6 U	12 U	11 U	18 U	11 U
Cis-1,2-Dichloroethene	UG/KG	0	0%		0	0	98					
Cis-1,3-Dichloropropene	UG/KG	0	0%		0	0	107		12 U	11 U	18 U	11 U
Cyclohexane	UG/KG	3	8%		0	8	98					
Dichlorodifluoromethane	UG/KG	0	0%		0	0	98					
Ethyl benzene	UG/KG	4.6	1%	5500	0	2	177	5.6 U	12 U	11 U	18 U	11 U
Isopropylbenzene	UG/KG	0	0%		0	0	98					
Meta/Para Xylene	UG/KG	9.4	4%		0	3	70	5.6 U				
Methyl Acetate	UG/KG	2	3%		0	3	98					
Methyl Tertbutyl Ether	UG/KG	0	0%		0	0	98					
Methyl bromide	UG/KG	0	0%		0	0	107		12 U	11 U	18 U	11 U
Methyl butyl ketone	UG/KG	0	0%		0	0	107		12 U	11 U	18 U	11 U
Methyl chloride	UG/KG	0	0%		0	0	107		12 U	11 U	18 U	11 U
Methyl cyclohexane	UG/KG	5	10%		0	10	98					
Methyl ethyl ketone	UG/KG	190	12%	300	0	22	177	11 U	12 J	11 U	18 U	11 U
Methyl isobutyl ketone	UG/KG	1.9	1%	1000	0	1	177	11 U	12 U	11 U	18 U	11 U
Methylene chloride	UG/KG	4.9	20%	100	0	36	178	5.6 U	12 U	11 U	2 J	11 U
Ortho Xylene	UG/KG	5.05	4%		0	3	70	5.6 U				

**Table A-2A
SURFACE SOIL SAMPLE RESULTS (0-2 ft.)
SEAD-59
SEAD-59 and SEAD-71 Phase II RI Report
Seneca Army Depot Activity**

Facility	SEAD-59	SEAD-59	SEAD-59	SEAD-59	SEAD-59
Location ID	CL-59-OTHERC-WW1	SB59-2	SB59-3	SB59-4	SB59-4
Maxitrix	SOIL	SOIL	SOIL	SOIL	SOIL
Sample ID	CL-59-OTHERC-WW1	SB59-2-02	SB59-3-04	SB59-4-05	SB59-4-10
Sample Depth to Top of Sample ⁽¹⁾	0	2	6	8	10
Sample Depth to Bottom of Sample ⁽¹⁾	0	4	8	10	20
Sample Date	5/6/2004	5/26/1994	5/25/1994	5/25/1994	5/25/1994
QC Code	SA	SA	SA	SA	SA
Study ID	ENSR IRM	ESI	ESI	ESI	ESI
Sample Round	1				

Parameter	Units	Maximum Value	Frequency of Detection	NYSDEC TAGM 4046 ⁽²⁾	Number of Exceedances	Number of Detects	Number of Analyses ⁽³⁾	Value (Q)	Value (Q)	Value (Q)	Value (Q)	Value (Q)
Styrene	UG/KG	0	0%		0	0	107		12 U	11 U	18 U	11 U
Tetrachloroethene	UG/KG	6.4	3%	1400	0	5	177	5.6 U	12 U	11 U	18 U	11 U
Toluene	UG/KG	8	8%	1500	0	14	177	5.6 U	12 U	11 U	18 U	11 U
Total BTEX	MG/KG	3.25	67%		0	2	3					
Total Xylenes	UG/KG	3	7%	1200	0	7	102		12 U	11 U	18 U	11 U
Trans-1,2-Dichloroethene	UG/KG	0	0%	300	0	0	168	5.6 U				
Trans-1,3-Dichloropropene	UG/KG	0	0%		0	0	107		12 U	11 U	18 U	11 U
Trichloroethene	UG/KG	4.5	5%	700	0	8	177	5.6 U	12 U	11 U	18 U	11 U
Trichlorofluoromethane	UG/KG	6	1%		0	1	98					
Vinyl chloride	UG/KG	0	0%	200	0	0	177	11 U	12 U	11 U	18 U	11 U
Semivolatile Organics												
1,1'-Biphenyl	UG/KG	254.5	2%		0	2	99					
1,2,4-Trichlorobenzene	UG/KG	0	0%	3400	0	0	9		820 U	360 U	420 U	360 U
1,2-Dichlorobenzene	UG/KG	0	0%	7900	0	0	9		820 U	360 U	420 U	360 U
1,3-Dichlorobenzene	UG/KG	0	0%	1600	0	0	9		820 U	360 U	420 U	360 U
1,4-Dichlorobenzene	UG/KG	0	0%	8500	0	0	9		820 U	360 U	420 U	360 U
2,2'-oxybis(1-Chloropropane)	UG/KG	0	0%		0	0	105		820 U	360 U	420 U	360 U
2,4,5-Trichlorophenol	UG/KG	0	0%	100	0	0	178	370 U	2000 U	880 U	1000 U	870 U
2,4,6-Trichlorophenol	UG/KG	0	0%		0	0	178	370 U	820 U	360 U	420 U	360 U
2,4-Dichlorophenol	UG/KG	0	0%	400	0	0	178	370 U	820 U	360 U	420 U	360 U
2,4-Dimethylphenol	UG/KG	0	0%		0	0	108		820 U	360 U	420 U	360 U
2,4-Dinitrophenol	UG/KG	0	0%	200	0	0	178	1900 U	2000 U	880 U	1000 U	870 U
2,4-Dinitrotoluene	UG/KG	0	0%		0	0	178	370 U	820 U	360 U	420 U	360 U
2,6-Dinitrotoluene	UG/KG	0	0%	1000	0	0	178	370 U	820 U	360 U	420 U	360 U
2-Chloronaphthalene	UG/KG	0	0%		0	0	108		820 U	360 U	420 U	360 U
2-Chlorophenol	UG/KG	0	0%	800	0	0	178	370 U	820 U	360 U	420 U	360 U
2-Methylnaphthalene	UG/KG	1295	19%	36400	0	34	178	370 U	160 J	360 U	37 J	360 U
2-Methylphenol	UG/KG	0	0%	100	0	0	178	370 U	820 U	360 U	420 U	360 U
2-Nitroaniline	UG/KG	0	0%	430	0	0	178	1900 U	2000 U	880 U	1000 U	870 U
2-Nitrophenol	UG/KG	0	0%	330	0	0	178	370 U	820 U	360 U	420 U	360 U
3,3'-Dichlorobenzidine	UG/KG	0	0%		0	0	178	370 U	820 U	360 U	420 U	360 U
3-Nitroaniline	UG/KG	0	0%	500	0	0	178	1900 U	2000 U	880 U	1000 U	870 U
4,6-Dinitro-2-methylphenol	UG/KG	0	0%		0	0	108		2000 U	880 U	1000 U	870 U
4-Bromophenyl phenyl ether	UG/KG	0	0%		0	0	108		820 U	360 U	420 U	360 U
4-Chloro-3-methylphenol	UG/KG	0	0%	240	0	0	178	370 U	820 U	360 U	420 U	360 U
4-Chloroaniline	UG/KG	1200	1%	220	1	2	178	370 U	820 U	360 U	420 U	360 U
4-Chlorophenyl phenyl ether	UG/KG	0	0%		0	0	108		820 U	360 U	420 U	360 U
4-Methylphenol	UG/KG	150	3%	900	0	5	178	370 U	820 U	360 U	420 U	360 U
4-Nitroaniline	UG/KG	0	0%		0	0	108		2000 U	880 U	1000 U	870 U
4-Nitrophenol	UG/KG	0	0%	100	0	0	178	1900 U	2000 U	880 U	1000 U	870 U
Acenaphthene	UG/KG	2680	24%	50000	0	42	178	370 U	230 J	360 U	93 J	360 U
Acenaphthylene	UG/KG	1700	37%	41000	0	66	178	370 U	100 J	360 U	52 J	360 U
Acetophenone	UG/KG	0	0%		0	0	99					
Aniline	UG/KG	0	0%		0	0	70	370 U				
Anthracene	UG/KG	4395	43%	50000	0	77	178	370 U	440 J	360 U	250 J	360 U

**Table A-2A
SURFACE SOIL SAMPLE RESULTS (0-2 ft.)
SEAD-59
SEAD-59 and SEAD-71 Phase II RI Report
Seneca Army Depot Activity**

Facility	SEAD-59	SEAD-59	SEAD-59	SEAD-59	SEAD-59							
Location ID	CL-59-OTHERC-WW1	SB59-2	SB59-3	SB59-4	SB59-4							
Maxitrix	SOIL	SOIL	SOIL	SOIL	SOIL							
Sample ID	CL-59-OTHERC-WW1	SB59-2-02	SB59-3-04	SB59-4-05	SB59-4-10							
Sample Depth to Top of Sample ⁽¹⁾	0	2	6	8	10							
Sample Depth to Bottom of Sample ⁽¹⁾	0	4	8	10	20							
Sample Date	5/6/2004	5/26/1994	5/25/1994	5/25/1994	5/25/1994							
QC Code	SA	SA	SA	SA	SA							
Study ID	ENSR IRM	ESI	ESI	ESI	ESI							
Sample Round	1											
Parameter	Units	Maximum	Frequency of	NYSDEC	Number of	Number of	Number of	Value (Q)	Value (Q)	Value (Q)	Value (Q)	Value (Q)
		Value	Detection	TAGM 4046 ⁽²⁾	Exceedances	Detects	Analyses ⁽³⁾					
Atrazine	UG/KG	120	1%		0	1	99					
Benzaldehyde	UG/KG	50	1%		0	1	99					
Benzo(a)anthracene	UG/KG	8900	51%	224	72	90	178	370 U	1600	360 U	740	360 U
Benzo(a)pyrene	UG/KG	8050	51%	61	84	91	178	370 U	1500	360 U	360	360 U
Benzo(b)fluoranthene	UG/KG	6800	52%	1100	40	92	178	370 U	3100 J	360 U	730	360 U
Benzo(ghi)perylene	UG/KG	5200	46%	50000	0	82	178	370 U	740 J	360 U	420 U	360 U
Benzo(k)fluoranthene	UG/KG	7350	49%	1100	35	88	178	370 U	820 UJ	360 U	590	360 U
Benzoic Acid	UG/KG	0	0%	2700	0	0	70	1900 U				
Bis(2-Chloroethoxy)methane	UG/KG	0	0%		0	0	108		820 U	360 U	420 U	360 U
Bis(2-Chloroethyl)ether	UG/KG	0	0%		0	0	108		820 U	360 U	420 U	360 U
Bis(2-Chloroisopropyl)ether	UG/KG	0	0%		0	0	3					
Bis(2-Ethylhexyl)phthalate	UG/KG	990	19%	50000	0	34	178	370 U	72 J	360 U	420 U	360 U
Butylbenzylphthalate	UG/KG	0	0%	50000	0	0	178	370 U	820 U	360 U	420 U	360 U
Caprolactam	UG/KG	0	0%		0	0	99					
Carbazole	UG/KG	755	19%		0	20	108		220 J	360 U	160 J	360 U
Chrysene	UG/KG	8900	51%	400	62	91	178	370 U	1500	360 U	820	360 U
Di-n-butylphthalate	UG/KG	965	2%	8100	0	4	178	370 U	820 U	360 U	120 J	360 U
Di-n-octylphthalate	UG/KG	0	0%	50000	0	0	178	370 U	820 U	360 U	420 U	360 U
Dibenz(a,h)anthracene	UG/KG	1665	38%	14	67	68	178	370 U	470 J	360 U	160 J	360 U
Dibenzofuran	UG/KG	2350	16%	6200	0	28	178	370 U	820 U	360 U	64 J	360 U
Diethyl phthalate	UG/KG	10	1%	7100	0	1	178	370 U	820 U	360 U	420 U	360 U
Dimethylphthalate	UG/KG	0	0%	2000	0	0	178	370 U	820 U	360 U	420 U	360 U
Fluoranthene	UG/KG	23500	54%	50000	0	97	178	370 U	3200	360 U	1900	19 J
Fluorene	UG/KG	2640	28%	50000	0	49	178	370 U	380 J	360 U	100 J	360 U
Hexachlorobenzene	UG/KG	0	0%	410	0	0	178	370 U	820 U	360 U	420 U	360 U
Hexachlorobutadiene	UG/KG	0	0%		0	0	178	370 U	820 U	360 U	420 U	360 U
Hexachlorocyclopentadiene	UG/KG	0	0%		0	0	108		820 U	360 U	420 U	360 U
Hexachloroethane	UG/KG	0	0%		0	0	178	370 U	820 U	360 U	420 U	360 U
Indeno(1,2,3-cd)pyrene	UG/KG	4950	47%	3200	2	84	178	370 U	940	360 U	300 J	360 U
Isophorone	UG/KG	0	0%	4400	0	0	178	370 U	820 U	360 U	420 U	360 U
N-Nitrosodiphenylamine	UG/KG	100	1%		0	1	108		820 U	360 U	420 U	360 U
N-Nitrosodipropylamine	UG/KG	0	0%		0	0	108		820 U	360 U	420 U	360 U
Naphthalene	UG/KG	1800	19%	13000	0	34	178	370 U	170 J	360 U	100 J	360 U
Nitrobenzene	UG/KG	0	0%	200	0	0	178	370 U	820 U	360 U	420 U	360 U
Pentachlorophenol	UG/KG	0	0%	1000	0	0	178	1900 U	2000 U	880 U	1000 U	870 U
Phenanthrene	UG/KG	21300	51%	50000	0	90	178	370 U	1800	360 U	1100	360 U
Phenol	UG/KG	0	0%	30	0	0	178	370 U	820 U	360 U	420 U	360 U
Pyrene	UG/KG	19200	55%	50000	0	98	178	370 U	3200	360 U	940	28 J
Pyridine	UG/KG	0	0%		0	0	100	1900 U				
Total Unknown PAHs as SV	MG/KG	25	100%		0	3	3					
Pesticides/PCBs												
4,4'-DDD	UG/KG	740	28%	2900	0	49	178	19 U	48 J	3.6 UJ	450	3.6 UJ
4,4'-DDE	UG/KG	2600	37%	2100	1	65	178	19 U	81 J	3.6 UJ	140	3.6 UJ
4,4'-DDT	UG/KG	3700	33%	2100	1	59	178	19 U	16 J	3.6 UJ	350	3.6 UJ
Aldrin	UG/KG	1.2	1%	41	0	1	178	9.5 U	1.2 J	1.9 UJ	22 U	1.8 UJ

Table A-2A
SURFACE SOIL SAMPLE RESULTS (0-2 ft.)
SEAD-59
SEAD-59 and SEAD-71 Phase II RI Report
Seneca Army Depot Activity

Facility	SEAD-59	SEAD-59	SEAD-59	SEAD-59	SEAD-59
Location ID	CL-59-OTHERC-WW1	SB59-2	SB59-3	SB59-4	SB59-4
Maxitrix	SOIL	SOIL	SOIL	SOIL	SOIL
Sample ID	CL-59-OTHERC-WW1	SB59-2-02	SB59-3-04	SB59-4-05	SB59-4-10
Sample Depth to Top of Sample ⁽¹⁾	0	2	6	8	10
Sample Depth to Bottom of Sample ⁽¹⁾	0	4	8	10	20
Sample Date	5/6/2004	5/26/1994	5/25/1994	5/25/1994	5/25/1994
QC Code	SA	SA	SA	SA	SA
Study ID	ENSR IRM	ESI	ESI	ESI	ESI
Sample Round	1				

Parameter	Units	Maximum	Frequency of	NYSDEC	Number of	Number of	Number of	Value (Q)	Value (Q)	Value (Q)	Value (Q)	Value (Q)
		Value	Detection	TAGM 4046 ⁽²⁾	Exceedances	Detects	Analyses ⁽³⁾					
Alpha-BHC	UG/KG	0	0%	110	0	0	178	9.5 U	2.1 UJ	1.9 UJ	22 U	1.8 UJ
Alpha-Chlordane	UG/KG	34	4%		0	7	178	9.5 U	5.2 J	1.9 UJ	22 U	1.8 UJ
Beta-BHC	UG/KG	2.4	1%	200	0	1	178	9.5 U	2.1 UJ	1.9 UJ	22 U	1.8 UJ
Delta-BHC	UG/KG	0	0%	300	0	0	178	9.5 U	2.1 UJ	1.9 UJ	22 U	1.8 UJ
Dieldrin	UG/KG	0	0%	44	0	0	178	19 U	4.1 UJ	3.6 UJ	42 U	3.6 UJ
Endosulfan I	UG/KG	16	1%	900	0	1	178	9.5 U	16 J	1.9 UJ	22 U	1.8 UJ
Endosulfan II	UG/KG	0	0%	900	0	0	178	19 U	4.1 UJ	3.6 UJ	42 U	3.6 UJ
Endosulfan sulfate	UG/KG	6.2	1%	1000	0	1	178	19 U	4.1 UJ	3.6 UJ	42 U	3.6 UJ
Endrin	UG/KG	16	2%	100	0	3	178	19 U	4.1 UJ	3.6 UJ	42 U	3.6 UJ
Endrin aldehyde	UG/KG	4.9	1%		0	2	178	19 U	4.1 UJ	3.6 UJ	42 U	3.6 UJ
Endrin ketone	UG/KG	38	2%		0	4	178	19 U	4.1 UJ	3.6 UJ	42 U	3.6 UJ
Gamma-BHC/Lindane	UG/KG	0	0%	60	0	0	178	9.5 U	2.1 UJ	1.9 UJ	22 U	1.8 UJ
Gamma-Chlordane	UG/KG	24	8%	540	0	14	178	9.5 U	2.1 UJ	1.9 UJ	22 U	1.8 UJ
Heptachlor	UG/KG	0	0%	100	0	0	178	9.5 U	2.1 UJ	1.9 UJ	22 U	1.8 UJ
Heptachlor epoxide	UG/KG	3	1%	20	0	2	178	9.5 U	2.1 UJ	1.9 UJ	22 U	1.8 UJ
Methoxychlor	UG/KG	0	0%		0	0	178	95 U	21 UJ	19 UJ	220 U	18 UJ
Toxaphene	UG/KG	0	0%		0	0	178	190 U	210 UJ	190 UJ	2200 U	180 UJ
Aroclor-1016	UG/KG	0	0%		0	0	178	37 U	41 UJ	36 UJ	420 U	36 UJ
Aroclor-1221	UG/KG	0	0%		0	0	178	37 U	84 UJ	74 UJ	850 U	73 UJ
Aroclor-1232	UG/KG	0	0%		0	0	178	37 U	41 UJ	36 UJ	420 U	36 UJ
Aroclor-1242	UG/KG	0	0%		0	0	178	37 U	41 UJ	36 UJ	420 U	36 UJ
Aroclor-1248	UG/KG	0	0%		0	0	178	37 U	41 UJ	36 UJ	420 U	36 UJ
Aroclor-1254	UG/KG	0	0%	10000	0	0	178	37 U	41 UJ	36 UJ	420 U	36 UJ
Aroclor-1260	UG/KG	79	1%	10000	0	2	178	37 U	41 UJ	36 UJ	420 U	36 UJ
Metals												
Aluminum	MG/KG	18300	100%	19300	0	178	178	14200	12500	8020	4200	7550
Antimony	MG/KG	424	58%	5.9	5	104	178	3.2 UJ	0.84 J	0.15 UJ	424 J	0.22 UJ
Arsenic	MG/KG	32.2	100%	8.2	7	178	178	5.5	6	4.4	3.8	3.7
Barium	MG/KG	304	100%	300	1	178	178	136	93.4	62.9	304	21.1 J
Beryllium	MG/KG	2.6	99%	1.1	2	176	178	0.22	0.67 J	0.39 J	0.37 J	0.38 J
Cadmium	MG/KG	3.2	86%	2.3	2	153	178	0.27 U	0.9 J	0.52 J	3.2	0.42 J
Calcium	MG/KG	214000	100%	121000	1	178	178	3010	44500	71100	214000	61700
Chromium	MG/KG	39.3	100%	29.6	2	178	178	19.6	21.1	13.3	14.7	12.8
Cobalt	MG/KG	47.8	100%	30	2	178	178	11.7	11.7	7.9	4 J	7.7 J
Copper	MG/KG	305	100%	33	19	178	178	16.7	28.1	18.4	14.2	15.6
Cyanide	MG/KG	0	0%	0.35	0	9	9		0.56 U	0.51 U		0.47 U
Iron	MG/KG	64000	100%	36500	1	178	178	25900 J	24600	17600	6540	17300
Lead	MG/KG	164	100%	24.8	75	178	178	13.7 J	50.3	9.3 J	139 J	9.5 J
Magnesium	MG/KG	30200	100%	21500	3	178	178	3720	8540	18500	7980	14600
Manganese	MG/KG	1290	100%	1060	3	178	178	762 J	664	403	298	328
Mercury	MG/KG	0.95	95%	0.1	37	169	178	0.05	0.08 J	0.03 J	0.11	0.03 J
Nickel	MG/KG	88.3	100%	49	3	178	178	25.2	31.8	22.5	10.6	21.3
Potassium	MG/KG	2290	100%	2380	0	178	178	1150	1690 J	1370 J	845 J	1100 J
Selenium	MG/KG	1.5	9%	2	0	16	178	0.54 U	1.3	0.26 U	0.28 J	0.96 J
Silver	MG/KG	2.9	49%	0.75	62	87	178	0.54 U	0.32 J	0.11 UJ	0.11 J	0.15 UJ

**Table A-2A
SURFACE SOIL SAMPLE RESULTS (0-2 ft.)
SEAD-59
SEAD-59 and SEAD-71 Phase II RI Report
Seneca Army Depot Activity**

	SEAD-59	SEAD-59	SEAD-59	SEAD-59	SEAD-59
Facility	CL-59-OTHERC-WW1	SB59-2	SB59-3	SB59-4	SB59-4
Location ID	SOIL	SOIL	SOIL	SOIL	SOIL
Maxtrix	CL-59-OTHERC-WW1	SB59-2-02	SB59-3-04	SB59-4-05	SB59-4-10
Sample ID	0	2	6	8	10
Sample Depth to Top of Sample ⁽¹⁾	0	4	8	10	20
Sample Depth to Bottom of Sample ⁽¹⁾	5/6/2004	5/26/1994	5/25/1994	5/25/1994	5/25/1994
Sample Date	SA	SA	SA	SA	SA
QC Code	ENSR IRM	ESI	ESI	ESI	ESI
Study ID	1				
Sample Round					

Parameter	Units	Maximum Value	Frequency of Detection	NYSDEC TAGM 4046 ⁽²⁾	Number of Exceedances	Number of Detects	Number of Analyses ⁽³⁾	Value (Q)	Value (Q)	Value (Q)	Value (Q)	Value (Q)
Sodium	MG/KG	4060	99%	172	86	177	178	122	168 J	198 J	125 J	140 J
Thallium	MG/KG	1.8	29%	0.7	24	51	178	0.83 J	0.4 U	0.24 U	0.22 U	0.34 U
Vanadium	MG/KG	28.5	100%	150	0	178	178	27.4	24.2	13.6	13.9	12.1
Zinc	MG/KG	341	100%	110	19	178	178	73.2 J	115	53.6	341	54.9

- Note(s):
(1) - Historical sample depths are presented (I.e. prior to 2002 TCRA)
(2) - NYSDEC Technical and Administrative Guidance Memorandum (TAGM) HWR-94-4046, Revised January 24, 1994
(3) - Sample/Duplicate pair are presented as individual samples in this table. Statistical information used Sample Duplicate pairs as a single entity and averaged result values were used in risk assessment analysis.

U = compound was not detected
J = the reported value is an estimated concentration
UJ = the compound was not detected; the associated reporting limit is approximate
R = the data was rejected in the data validating process
NJ = compound was "tentatively identified" and the associated numerical value is approximate

Table A-2A
SURFACE SOIL SAMPLE RESULTS (0-2 ft.)
SEAD-59
SEAD-59 and SEAD-71 Phase II RI Report
Seneca Army Depot Activity

Facility	SEAD-59	SEAD-59	SEAD-59	SEAD-59	SEAD-59
Location ID	SB59-5	TP59-17-3	WS-59-01-004-7	WS-59-01-006-11	WS-59-01-006-2
Matrix	SOIL	SOIL	SOIL	SOIL	SOIL
Sample ID	SB59-5-03	59044	WS-59-01-004-7	WS-59-01-006-11	WS-59-01-006-2
Sample Depth to Top of Sample ⁽¹⁾	4	3	0	0	0
Sample Depth to Bottom of Sample ⁽¹⁾	6	3.5	0	0	0
Sample Date	5/25/1994	10/13/1997	5/6/2004	5/6/2004	5/6/2004
QC Code	SA	SA	SA	SA	SA
Study ID	ESI	RI PHASE 1 STEP 1	ENSR IRM	ENSR IRM	ENSR IRM
Sample Round			1	1	1

Parameter	Units	Maximum Value	Frequency of Detection	NYSDEC TAGM 4046 ⁽²⁾	Number of Exceedances	Number of Detects	Number of Analyses ⁽³⁾	Value (Q)	Value (Q)	Value (Q)	Value (Q)	Value (Q)
Volatile Organics												
1,1,1-Trichloroethane	UG/KG	0	0%	800	0	0	177	11 U	11 U	6 U	5.7 U	5.6 U
1,1,2,2-Tetrachloroethane	UG/KG	0	0%	600	0	0	169	11 U	11 U	6 U	5.7 U	5.6 U
1,1,2-Trichloro-1,2,2-Trifluoroethane	UG/KG	0	0%		0	0	168			6 U	5.7 U	5.6 U
1,1,2-Trichloroethane	UG/KG	0	0%		0	0	107	11 U	11 U			
1,1-Dichloroethane	UG/KG	0	0%	200	0	0	177	11 U	11 U	6 U	5.7 U	5.6 U
1,1-Dichloroethene	UG/KG	8	2%	400	0	3	177	11 U	11 U	6 U	5.7 U	5.6 U
1,2,3-Trichloropropane	UG/KG	0	0%		0	0	70			6 U	5.7 U	5.6 U
1,2,4-Trichlorobenzene	UG/KG	0	0%	3400	0	0	161			6 U	5.7 U	5.6 U
1,2-Dibromo-3-chloropropane	UG/KG	0	0%		0	0	91					
1,2-Dibromoethane	UG/KG	0	0%		0	0	98					
1,2-Dichlorobenzene	UG/KG	0	0%	7900	0	0	161			6 U	5.7 U	5.6 U
1,2-Dichloroethane	UG/KG	0	0%	100	0	0	177	11 U	11 U	6 U	5.7 U	5.6 U
1,2-Dichloroethene (total)	UG/KG	0	0%		0	0	9	11 U	11 U			
1,2-Dichloropropane	UG/KG	0	0%		0	0	107	11 U	11 U			
1,3-Dichlorobenzene	UG/KG	0	0%	1600	0	0	161			6 U	5.7 U	5.6 U
1,3-Dichloropropane	UG/KG	0	0%		0	0	70			6 U	5.7 U	5.6 U
1,4-Dichlorobenzene	UG/KG	0	0%	8500	0	0	161			6 U	5.7 U	5.6 U
Acetone	UG/KG	550	27%	200	2	47	177	11 U	11 U	24 U	23 U	22 U
Benzene	UG/KG	3	4%	60	0	7	177	11 U	11 U	6 U	5.7 U	5.6 U
Bromodichloromethane	UG/KG	0	0%		0	0	107	11 U	11 U			
Bromoform	UG/KG	0	0%		0	0	107	11 U	11 U			
Carbon disulfide	UG/KG	4	3%	2700	0	6	177	11 U	11 U	6 U	5.7 U	5.6 U
Carbon tetrachloride	UG/KG	0	0%	600	0	0	177	11 U	11 U	6 U	5.7 U	5.6 U
Chlorobenzene	UG/KG	0	0%	1700	0	0	177	11 U	11 U	6 U	5.7 U	5.6 U
Chlorodibromomethane	UG/KG	0	0%		0	0	177	11 U	11 U	6 U	5.7 U	5.6 U
Chloroethane	UG/KG	0	0%	1900	0	0	177	11 U	11 U	12 U	11 U	11 U
Chloroform	UG/KG	0	0%	300	0	0	177	11 U	11 U	6 U	5.7 U	5.6 U
Cis-1,2-Dichloroethene	UG/KG	0	0%		0	0	98					
Cis-1,3-Dichloropropene	UG/KG	0	0%		0	0	107	11 U	11 U			
Cyclohexane	UG/KG	3	8%		0	8	98					
Dichlorodifluoromethane	UG/KG	0	0%		0	0	98					
Ethyl benzene	UG/KG	4.6	1%	5500	0	2	177	11 U	11 U	6 U	5.7 U	5.6 U
Isopropylbenzene	UG/KG	0	0%		0	0	98					
Meta/Para Xylene	UG/KG	9.4	4%		0	3	70			6 U	5.7 U	5.6 U
Methyl Acetate	UG/KG	2	3%		0	3	98					
Methyl Tertbutyl Ether	UG/KG	0	0%		0	0	98					
Methyl bromide	UG/KG	0	0%		0	0	107	11 U	11 U			
Methyl butyl ketone	UG/KG	0	0%		0	0	107	11 U	11 U			
Methyl chloride	UG/KG	0	0%		0	0	107	11 U	11 U			
Methyl cyclohexane	UG/KG	5	10%		0	10	98					
Methyl ethyl ketone	UG/KG	190	12%	300	0	22	177	11 U	11 U	12 U	11 U	11 UJ
Methyl isobutyl ketone	UG/KG	1.9	1%	1000	0	1	177	11 U	11 U	12 U	11 U	11 U
Methylene chloride	UG/KG	4.9	20%	100	0	36	178	11 U	11 U	6 U	5.7 U	1.3 J
Ortho Xylene	UG/KG	5.05	4%		0	3	70			6 U	5.7 U	5.6 U

Table A-2A
SURFACE SOIL SAMPLE RESULTS (0-2 ft.)
SEAD-59
SEAD-59 and SEAD-71 Phase II RI Report
Seneca Army Depot Activity

Facility	SEAD-59	SEAD-59	SEAD-59	SEAD-59	SEAD-59
Location ID	SB59-5	TP59-17-3	WS-59-01-004-7	WS-59-01-006-11	WS-59-01-006-2
Matrix	SOIL	SOIL	SOIL	SOIL	SOIL
Sample ID	SB59-5-03	59044	WS-59-01-004-7	WS-59-01-006-11	WS-59-01-006-2
Sample Depth to Top of Sample ⁽¹⁾	4	3	0	0	0
Sample Depth to Bottom of Sample ⁽¹⁾	6	3.5	0	0	0
Sample Date	5/25/1994	10/13/1997	5/6/2004	5/6/2004	5/6/2004
QC Code	SA	SA	SA	SA	SA
Study ID	ESI	RI PHASE 1 STEP 1	ENSR IRM	ENSR IRM	ENSR IRM
Sample Round			1	1	1

Parameter	Units	Maximum Value	Frequency of Detection	NYSDEC TAGM 4046 ⁽²⁾	Number of Exceedances	Number of Detects	Number of Analyses ⁽³⁾	Value (Q)	Value (Q)	Value (Q)	Value (Q)	Value (Q)
Styrene	UG/KG	0	0%		0	0	107	11 U	11 U			
Tetrachloroethene	UG/KG	6.4	3%	1400	0	5	177	11 U	11 U	6 U	5.7 U	5.6 U
Toluene	UG/KG	8	8%	1500	0	14	177	11 U	2 J	6 U	5.7 U	5.6 U
Total BTEX	MG/KG	3.25	67%		0	2	3		2.8			
Total Xylenes	UG/KG	3	7%	1200	0	7	102	11 U	11 U			
Trans-1,2-Dichloroethene	UG/KG	0	0%	300	0	0	168			6 U	5.7 U	5.6 U
Trans-1,3-Dichloropropene	UG/KG	0	0%		0	0	107	11 U	11 U			
Trichloroethene	UG/KG	4.5	5%	700	0	8	177	1 J	11 U	6 U	1.6 J	1.6 J
Trichlorofluoromethane	UG/KG	6	1%		0	1	98					
Vinyl chloride	UG/KG	0	0%	200	0	0	177	11 U	11 U	12 U	11 U	11 U
Semivolatile Organics												
1,1'-Biphenyl	UG/KG	254.5	2%		0	2	99					
1,2,4-Trichlorobenzene	UG/KG	0	0%	3400	0	0	9	370 U	360 U			
1,2-Dichlorobenzene	UG/KG	0	0%	7900	0	0	9	370 U	360 U			
1,3-Dichlorobenzene	UG/KG	0	0%	1600	0	0	9	370 U	360 U			
1,4-Dichlorobenzene	UG/KG	0	0%	8500	0	0	9	370 U	360 U			
2,2'-oxybis(1-Chloropropane)	UG/KG	0	0%		0	0	105	370 U				
2,4,5-Trichlorophenol	UG/KG	0	0%	100	0	0	178	910 U	880 U	1200 U	1900 U	740 U
2,4,6-Trichlorophenol	UG/KG	0	0%		0	0	178	370 U	360 U	1200 U	1900 U	740 U
2,4-Dichlorophenol	UG/KG	0	0%	400	0	0	178	370 U	360 U	1200 U	1900 U	740 U
2,4-Dimethylphenol	UG/KG	0	0%		0	0	108	370 U	360 U			
2,4-Dinitrophenol	UG/KG	0	0%	200	0	0	178	910 U	880 U	6100 U	9700 U	3800 U
2,4-Dinitrotoluene	UG/KG	0	0%		0	0	178	370 U	360 U	1200 U	1900 U	740 U
2,6-Dinitrotoluene	UG/KG	0	0%	1000	0	0	178	370 U	360 U	1200 U	1900 U	740 U
2-Chloronaphthalene	UG/KG	0	0%		0	0	108	370 U	360 U			
2-Chlorophenol	UG/KG	0	0%	800	0	0	178	370 U	360 U	1200 U	1900 U	740 U
2-Methylnaphthalene	UG/KG	1295	19%	36400	0	34	178	45 J	970	220 J	1900 U	75 J
2-Methylphenol	UG/KG	0	0%	100	0	0	178	370 U	360 U	1200 U	1900 U	740 U
2-Nitroaniline	UG/KG	0	0%	430	0	0	178	910 U	880 U	6100 U	9700 U	3800 U
2-Nitrophenol	UG/KG	0	0%	330	0	0	178	370 U	360 U	1200 U	1900 U	740 U
3,3'-Dichlorobenzidine	UG/KG	0	0%		0	0	178	370 U	360 U	1200 U	1900 U	740 U
3-Nitroaniline	UG/KG	0	0%	500	0	0	178	910 U	880 U	6100 U	9700 U	3800 U
4,6-Dinitro-2-methylphenol	UG/KG	0	0%		0	0	108	910 U	880 U			
4-Bromophenyl phenyl ether	UG/KG	0	0%		0	0	108	370 U	360 U			
4-Chloro-3-methylphenol	UG/KG	0	0%	240	0	0	178	370 U	360 U	1200 U	1900 U	740 U
4-Chloroaniline	UG/KG	1200	1%	220	1	2	178	370 U	360 U	1200 U	1900 U	740 U
4-Chlorophenyl phenyl ether	UG/KG	0	0%		0	0	108	370 U	360 U			
4-Methylphenol	UG/KG	150	3%	900	0	5	178	370 U	360 U	1200 U	1900 U	740 U
4-Nitroaniline	UG/KG	0	0%		0	0	108	910 U	880 U			
4-Nitrophenol	UG/KG	0	0%	100	0	0	178	910 U	880 U	6100 U	9700 U	3800 U
Acenaphthene	UG/KG	2680	24%	50000	0	42	178	44 J	510	1200 U	320 J	150 J
Acenaphthylene	UG/KG	1700	37%	41000	0	66	178	190 J	130 J	120 J	1700 J	1100
Acetophenone	UG/KG	0	0%		0	0	99					
Aniline	UG/KG	0	0%		0	0	70			1200 U	1900 U	740 U
Anthracene	UG/KG	4395	43%	50000	0	77	178	410 J	210 J	130 J	1400 J	790

Table A-2A
SURFACE SOIL SAMPLE RESULTS (0-2 ft.)
SEAD-59
SEAD-59 and SEAD-71 Phase II RI Report
Seneca Army Depot Activity

Facility	SEAD-59	SEAD-59	SEAD-59	SEAD-59	SEAD-59
Location ID	SB59-5	TP59-17-3	WS-59-01-004-7	WS-59-01-006-11	WS-59-01-006-2
Matrix	SOIL	SOIL	SOIL	SOIL	SOIL
Sample ID	SB59-5-03	59044	WS-59-01-004-7	WS-59-01-006-11	WS-59-01-006-2
Sample Depth to Top of Sample ⁽¹⁾	4	3	0	0	0
Sample Depth to Bottom of Sample ⁽¹⁾	6	3.5	0	0	0
Sample Date	5/25/1994	10/13/1997	5/6/2004	5/6/2004	5/6/2004
QC Code	SA	SA	SA	SA	SA
Study ID	ESI	RI PHASE 1 STEP 1	ENSR IRM	ENSR IRM	ENSR IRM
Sample Round			1	1	1

Parameter	Units	Maximum	Frequency of	NYSDEC	Number of	Number of	Number of	Value (Q)	Value (Q)	Value (Q)	Value (Q)	Value (Q)
		Value	Detection	TAGM 4046 ⁽²⁾	Exceedances	Detects	Analyses ⁽³⁾					
Atrazine	UG/KG	120	1%		0	1	99					
Benzaldehyde	UG/KG	50	1%		0	1	99					
Benzo(a)anthracene	UG/KG	8900	51%	224	72	90	178	1400	1000	280 J	3200	2000
Benzo(a)pyrene	UG/KG	8050	51%	61	84	91	178	1200 J	1300	350 J	3800	2800
Benzo(b)fluoranthene	UG/KG	6800	52%	1100	40	92	178	1100 J	1000	250 J	2700	2000
Benzo(ghi)perylene	UG/KG	5200	46%	50000	0	82	178	150 J	900	220 J	2900	2200
Benzo(k)fluoranthene	UG/KG	7350	49%	1100	35	88	178	870 J	1200	280 J	2600	1900
Benzoic Acid	UG/KG	0	0%	2700	0	0	70			6100 U	9700 UJ	3800 UJ
Bis(2-Chloroethoxy)methane	UG/KG	0	0%		0	0	108	370 U	360 U			
Bis(2-Chloroethyl)ether	UG/KG	0	0%		0	0	108	370 U	360 U			
Bis(2-Chloroisopropyl)ether	UG/KG	0	0%		0	0	3		360 U			
Bis(2-Ethylhexyl)phthalate	UG/KG	990	19%	50000	0	34	178	370 U	360 U	210 J	1900 U	740 U
Butylbenzylphthalate	UG/KG	0	0%	50000	0	0	178	370 U	360 U	1200 U	1900 U	740 U
Caprolactam	UG/KG	0	0%		0	0	99					
Carbazole	UG/KG	755	19%		0	20	108	370 U	150 J			
Chrysene	UG/KG	8900	51%	400	62	91	178	1400	1100	330 J	3200	2100
Di-n-butylphthalate	UG/KG	965	2%	8100	0	4	178	370 U	360 U	1200 U	1900 U	740 U
Di-n-octylphthalate	UG/KG	0	0%	50000	0	0	178	370 U	360 U	1200 U	1900 U	740 U
Dibenz(a,h)anthracene	UG/KG	1665	38%	14	67	68	178	300 J	350 J	1200 U	900 J	630 J
Dibenzofuran	UG/KG	2350	16%	6200	0	28	178	28 J	440	1200 U	1900 U	740 U
Diethyl phthalate	UG/KG	10	1%	7100	0	1	178	370 U	360 U	1200 U	1900 U	740 U
Dimethylphthalate	UG/KG	0	0%	2000	0	0	178	370 U	360 U	1200 U	1900 U	740 U
Fluoranthene	UG/KG	23500	54%	50000	0	97	178	2300 J	1900	560 J	6600	3900
Fluorene	UG/KG	2640	28%	50000	0	49	178	90 J	220 J	1200 U	320 J	150 NJ
Hexachlorobenzene	UG/KG	0	0%	410	0	0	178	370 U	360 U	1200 U	1900 U	740 U
Hexachlorobutadiene	UG/KG	0	0%		0	0	178	370 U	360 U	1200 U	1900 U	740 U
Hexachlorocyclopentadiene	UG/KG	0	0%		0	0	108	370 U	360 U			
Hexachloroethane	UG/KG	0	0%		0	0	178	370 U	360 U	1200 U	1900 U	740 U
Indeno(1,2,3-cd)pyrene	UG/KG	4950	47%	3200	2	84	178	570 J	840	200 J	2600 J	1900 J
Isophorone	UG/KG	0	0%	4400	0	0	178	370 U	360 U	1200 U	1900 U	740 U
N-Nitrosodiphenylamine	UG/KG	100	1%		0	1	108	370 U	360 U			
N-Nitrosodipropylamine	UG/KG	0	0%		0	0	108	370 U	360 U			
Naphthalene	UG/KG	1800	19%	13000	0	34	178	44 J	610	1200 U	1900 U	90 NJ
Nitrobenzene	UG/KG	0	0%	200	0	0	178	370 U	360 U	1200 U	1900 U	740 U
Pentachlorophenol	UG/KG	0	0%	1000	0	0	178	910 U	880 U	6100 U	9700 U	3800 U
Phenanthrene	UG/KG	21300	51%	50000	0	90	178	1200 J	830	350 J	3200	1600
Phenol	UG/KG	0	0%	30	0	0	178	370 U	360 U	1200 U	1900 U	740 U
Pyrene	UG/KG	19200	55%	50000	0	98	178	2800	1600	470 J	5400	3900
Pyridine	UG/KG	0	0%		0	0	100			6100 U	9700 U	3800 U
Total Unknown PAHs as SV	MG/KG	25	100%		0	3			25 J			
Pesticides/PCBs												
4,4'-DDD	UG/KG	740	28%	2900	0	49	178	22 J	11 J	38	19 U	23 J
4,4'-DDE	UG/KG	2600	37%	2100	1	65	178	21	15	43	21	90 J
4,4'-DDT	UG/KG	3700	33%	2100	1	59	178	23 J	24	42	19 U	55 J
Aldrin	UG/KG	1.2	1%	41	0	1	178	3.9 U	1.9 U	10 U	9.7 U	9.5 U

**Table A-2A
SURFACE SOIL SAMPLE RESULTS (0-2 ft.)
SEAD-59
SEAD-59 and SEAD-71 Phase II RI Report
Seneca Army Depot Activity**

Facility	SEAD-59	SEAD-59	SEAD-59	SEAD-59	SEAD-59
Location ID	SB59-5	TP59-17-3	WS-59-01-004-7	WS-59-01-006-11	WS-59-01-006-2
Matrix	SOIL	SOIL	SOIL	SOIL	SOIL
Sample ID	SB59-5-03	59044	WS-59-01-004-7	WS-59-01-006-11	WS-59-01-006-2
Sample Depth to Top of Sample ⁽¹⁾	4	3	0	0	0
Sample Depth to Bottom of Sample ⁽¹⁾	6	3.5	0	0	0
Sample Date	5/25/1994	10/13/1997	5/6/2004	5/6/2004	5/6/2004
QC Code	SA	SA	SA	SA	SA
Study ID	ESI	RI PHASE 1 STEP 1	ENSR IRM	ENSR IRM	ENSR IRM
Sample Round			1	1	1

Parameter	Units	Maximum	Frequency of	NYSDEC	Number of	Number of	Number of	Value (Q)	Value (Q)	Value (Q)	Value (Q)	Value (Q)
		Value	Detection	TAGM 4046 ⁽²⁾	Exceedances	Detects	Analyses ⁽³⁾					
Alpha-BHC	UG/KG	0	0%	110	0	0	178	3.9 U	1.9 U	10 U	9.7 U	9.5 U
Alpha-Chlordane	UG/KG	34	4%		0	7	178	3.9 U	1.9 U	10 U	9.7 U	9.5 U
Beta-BHC	UG/KG	2.4	1%	200	0	1	178	3.9 U	1.9 U	10 U	9.7 U	9.5 U
Delta-BHC	UG/KG	0	0%	300	0	0	178	3.9 U	1.9 U	10 U	9.7 U	9.5 U
Dieldrin	UG/KG	0	0%	44	0	0	178	7.5 U	3.6 U	20 U	19 U	18 U
Endosulfan I	UG/KG	16	1%	900	0	1	178	3.9 U	1.9 U	10 U	9.7 U	9.5 U
Endosulfan II	UG/KG	0	0%	900	0	0	178	7.5 U	3.6 U	20 U	19 U	18 U
Endosulfan sulfate	UG/KG	6.2	1%	1000	0	1	178	7.5 U	3.6 U	20 U	19 U	18 U
Endrin	UG/KG	16	2%	100	0	3	178	7.5 U	6.2	20 U	19 U	18 U
Endrin aldehyde	UG/KG	4.9	1%		0	2	178	7.5 U	3.7 J	20 U	19 U	18 U
Endrin ketone	UG/KG	38	2%		0	4	178	7.5 U	3.3 J	20 U	19 U	18 U
Gamma-BHC/Lindane	UG/KG	0	0%	60	0	0	178	3.9 U	1.9 U	10 U	9.7 U	9.5 U
Gamma-Chlordane	UG/KG	24	8%	540	0	14	178	2.2 J	1 J	10 U	9.7 U	9.5 U
Heptachlor	UG/KG	0	0%	100	0	0	178	3.9 U	1.9 U	10 U	9.7 U	9.5 U
Heptachlor epoxide	UG/KG	3	1%	20	0	2	178	3.9 U	1.6 J	10 U	9.7 U	9.5 U
Methoxychlor	UG/KG	0	0%		0	0	178	39 U	19 U	100 U	97 U	95 U
Toxaphene	UG/KG	0	0%		0	0	178	390 U	190 U	200 U	190 U	180 U
Aroclor-1016	UG/KG	0	0%		0	0	178	75 U	36 U	40 U	38 U	37 U
Aroclor-1221	UG/KG	0	0%		0	0	178	150 U	74 U	40 U	38 U	37 U
Aroclor-1232	UG/KG	0	0%		0	0	178	75 U	36 U	40 U	38 U	37 U
Aroclor-1242	UG/KG	0	0%		0	0	178	75 U	36 U	40 U	38 U	37 U
Aroclor-1248	UG/KG	0	0%		0	0	178	75 U	36 U	40 U	38 U	37 U
Aroclor-1254	UG/KG	0	0%	10000	0	0	178	75 U	36 U	40 U	38 U	37 U
Aroclor-1260	UG/KG	79	1%	10000	0	2	178	75 U	36 U	40 U	38 U	37 U
Metals												
Aluminum	MG/KG	18300	100%	19300	0	178	178	12800	12300 J	9670	11100	9720
Antimony	MG/KG	424	58%	5.9	5	104	178	0.2 UJ	0.56 UJ	3.5 UJ	3.4 UJ	3.2 UJ
Arsenic	MG/KG	32.2	100%	8.2	7	178	178	5.5	5.5	4.3	5.2 J	4.1
Barium	MG/KG	304	100%	300	1	178	178	81.9	69.5	85.1	93.9	78.5
Beryllium	MG/KG	2.6	99%	1.1	2	176	178	0.61 J	0.46	0.25 J	0.34	0.2
Cadmium	MG/KG	3.2	86%	2.3	2	153	178	0.91 J	0.08 U	0.39 J	0.69	0.46 J
Calcium	MG/KG	214000	100%	121000	1	178	178	62800	59600	46500 J	53300	59200
Chromium	MG/KG	39.3	100%	29.6	2	178	178	20.1	21.2	15.6	20.1	15.8
Cobalt	MG/KG	47.8	100%	30	2	178	178	10.8	12.6	7.5	10.8	9.3
Copper	MG/KG	305	100%	33	19	178	178	26	30.2	21.8	28.4 J	22.1
Cyanide	MG/KG	0	0%	0.35	0	0	9	0.5 U	0.66 U			
Iron	MG/KG	64000	100%	36500	1	178	178	24100	25800	17400 J	20400	18400
Lead	MG/KG	164	100%	24.8	75	178	178	42.1 J	30.4 J	29.5 J	70.4	28.9
Magnesium	MG/KG	30200	100%	21500	3	178	178	11500	12900 J	7000 J	12300	9840
Manganese	MG/KG	1290	100%	1060	3	178	178	640	454 J	582	526	476
Mercury	MG/KG	0.95	95%	0.1	37	169	178	0.15	0.05 U	0.04	0.09	0.04
Nickel	MG/KG	88.3	100%	49	3	178	178	29.8	41.4	21.5	30	25.4
Potassium	MG/KG	2290	100%	2380	0	178	178	1710 J	1780	1240	1110	947
Selenium	MG/KG	1.5	9%	2	0	16	178	0.53 J	0.77 U	0.58 U	0.57 U	0.53 UJ
Silver	MG/KG	2.9	49%	0.75	62	87	178	0.14 UJ	0.21 U	0.58 U	0.57 UJ	0.53 U

**Table A-2A
SURFACE SOIL SAMPLE RESULTS (0-2 ft.)
SEAD-59
SEAD-59 and SEAD-71 Phase II RI Report
Seneca Army Depot Activity**

Facility	SEAD-59	SEAD-59	SEAD-59	SEAD-59	SEAD-59
Location ID	SB59-5	TP59-17-3	WS-59-01-004-7	WS-59-01-006-11	WS-59-01-006-2
Maxtrix	SOIL	SOIL	SOIL	SOIL	SOIL
Sample ID	SB59-5-03	59044	WS-59-01-004-7	WS-59-01-006-11	WS-59-01-006-2
Sample Depth to Top of Sample ⁽¹⁾	4	3	0	0	0
Sample Depth to Bottom of Sample ⁽¹⁾	6	3.5	0	0	0
Sample Date	5/25/1994	10/13/1997	5/6/2004	5/6/2004	5/6/2004
QC Code	SA	SA	SA	SA	SA
Study ID	ESI	RI PHASE 1 STEP 1	ENSR IRM	ENSR IRM	ENSR IRM
Sample Round			1	1	1

Parameter	Units	Maximum Value	Frequency of Detection	NYSDEC TAGM 4046 ⁽²⁾	Number of Exceedances	Number of Detects	Number of Analyses ⁽³⁾	Value (Q)	Value (Q)	Value (Q)	Value (Q)	Value (Q)
Sodium	MG/KG	4060	99%	172	86	177	178	161 J	155	173	197	107
Thallium	MG/KG	1.8	29%	0.7	24	51	178	0.32 U	1.2 U	0.85 J	0.57 U	0.72 J
Vanadium	MG/KG	28.5	100%	150	0	178	178	23.2	21.2	19.4	20	16.5
Zinc	MG/KG	341	100%	110	19	178	178	101	83.8 J	75.8 J	123 J	78.8

Note(s):

- (1) - Historical sample depths are presented (I.e. prior to 2002 TCRA)
- (2) - NYSDEC Technical and Administrative Guidance Memorandum (TAGM) HWR-94-4046, Revised January 24, 1994
- (3) - Sample/Duplicate pair are presented as individual samples in this table. Statistical information used Sample Duplicate pairs as a single entity and averaged result values were used in risk assessment analysis.

U = compound was not detected

J = the reported value is an estimated concentration

UJ = the compound was not detected; the associated reporting limit is approximate

R = the data was rejected in the data validating process

NJ = compound was "tentatively identified" and the associated numerical value is approximate

Table A-2A
SURFACE SOIL SAMPLE RESULTS (0-2 ft.)
SEAD-59
SEAD-59 and SEAD-71 Phase II RI Report
Seneca Army Depot Activity

Facility	SEAD-59	SEAD-59	SEAD-59	SEAD-59	SEAD-59
Location ID	WS-59-01-006-4	WS-59-01-006-5	WS-59-01-006-6	WS-59-01-006-8	WS-59-01-007-3
Matrix	SOIL	SOIL	SOIL	SOIL	SOIL
Sample ID	WS-59-01-006-4	WS-59-01-006-5	WS-59-01-006-6	WS-59-01-006-8	WS-59-01-007-3
Sample Depth to Top of Sample ⁽¹⁾	0	0	0	0	0
Sample Depth to Bottom of Sample ⁽¹⁾	0	0	0	0	0
Sample Date	5/6/2004	5/6/2004	5/6/2004	5/6/2004	5/6/2004
QC Code	SA	SA	SA	SA	SA
Study ID	ENSR IRM	ENSR IRM	ENSR IRM	ENSR IRM	ENSR IRM
Sample Round	1	1	1	1	1

Parameter	Units	Maximum Value	Frequency of Detection	NYSDEC TAGM 4046 ⁽²⁾	Number of Exceedances	Number of Detects	Number of Analyses ⁽³⁾	Value (Q)	Value (Q)	Value (Q)	Value (Q)	Value (Q)
Volatile Organics												
1,1,1-Trichloroethane	UG/KG	0	0%	800	0	0	177	5.7 U	5.6 U	5.9 U	5.7 U	5.9 U
1,1,2,2-Tetrachloroethane	UG/KG	0	0%	600	0	0	169	5.7 U	5.6 U	5.9 U	5.7 U	5.9 U
1,1,2-Trichloro-1,2,2-Trifluoroethane	UG/KG	0	0%		0	0	168	5.7 U	5.6 U	5.9 U	5.7 U	5.9 U
1,1,2-Trichloroethane	UG/KG	0	0%		0	0	107					
1,1-Dichloroethane	UG/KG	0	0%	200	0	0	177	5.7 U	5.6 U	5.9 U	5.7 U	5.9 U
1,1-Dichloroethene	UG/KG	8	2%	400	0	3	177	5.7 U	5.6 U	5.9 U	5.7 U	5.9 U
1,2,3-Trichloropropane	UG/KG	0	0%		0	0	70		5.6 U	5.9 U	5.7 U	5.9 U
1,2,4-Trichlorobenzene	UG/KG	0	0%	3400	0	0	161	5.7 U	5.6 U	5.9 U	5.7 U	5.9 U
1,2-Dibromo-3-chloropropane	UG/KG	0	0%		0	0	91					
1,2-Dibromoethane	UG/KG	0	0%		0	0	98					
1,2-Dichlorobenzene	UG/KG	0	0%	7900	0	0	161	5.7 U	5.6 U	5.9 U	5.7 U	5.9 U
1,2-Dichloroethane	UG/KG	0	0%	100	0	0	177	5.7 U	5.6 U	5.9 U	5.7 U	5.9 U
1,2-Dichloroethene (total)	UG/KG	0	0%		0	0	9					
1,2-Dichloropropane	UG/KG	0	0%		0	0	107					
1,3-Dichlorobenzene	UG/KG	0	0%	1600	0	0	161	5.7 U	5.6 U	5.9 U	5.7 U	5.9 U
1,3-Dichloropropane	UG/KG	0	0%		0	0	70	5.7 U	5.6 U	5.9 U	5.7 U	5.9 U
1,4-Dichlorobenzene	UG/KG	0	0%	8500	0	0	161	5.7 U	5.6 U	5.9 U	5.7 U	5.9 U
Acetone	UG/KG	550	27%	200	2	47	177	23 U	4 J	7.1 J	23 U	20 J
Benzene	UG/KG	3	4%	60	0	7	177	5.7 U	5.6 U	5.9 U	5.7 U	5.9 U
Bromodichloromethane	UG/KG	0	0%		0	0	107					
Bromoform	UG/KG	0	0%		0	0	107					
Carbon disulfide	UG/KG	4	3%	2700	0	6	177	5.7 U	5.6 U	5.9 U	5.7 U	5.9 U
Carbon tetrachloride	UG/KG	0	0%	600	0	0	177	5.7 U	5.6 U	5.9 U	5.7 U	5.9 U
Chlorobenzene	UG/KG	0	0%	1700	0	0	177	5.7 U	5.6 U	5.9 U	5.7 U	5.9 U
Chlorodibromomethane	UG/KG	0	0%		0	0	177	5.7 U	5.6 U	5.9 U	5.7 U	5.9 U
Chloroethane	UG/KG	0	0%	1900	0	0	177	11 U	11 U	12 U	11 U	12 U
Chloroform	UG/KG	0	0%	300	0	0	177	5.7 U	5.6 U	5.9 U	5.7 U	5.9 U
Cis-1,2-Dichloroethene	UG/KG	0	0%		0	0	98					
Cis-1,3-Dichloropropene	UG/KG	0	0%		0	0	107					
Cyclohexane	UG/KG	3	8%		0	8	98					
Dichlorodifluoromethane	UG/KG	0	0%		0	0	98					
Ethyl benzene	UG/KG	4.6	1%	5500	0	2	177	5.7 U	5.6 U	5.9 U	5.7 U	5.9 U
Isopropylbenzene	UG/KG	0	0%		0	0	98					
Meta/Para Xylene	UG/KG	9.4	4%		0	3	70	5.1 J	5.6 U	5.9 U	5.7 U	5.9 U
Methyl Acetate	UG/KG	2	3%		0	3	98					
Methyl Tertbutyl Ether	UG/KG	0	0%		0	0	98					
Methyl bromide	UG/KG	0	0%		0	0	107					
Methyl butyl ketone	UG/KG	0	0%		0	0	107					
Methyl chloride	UG/KG	0	0%		0	0	107					
Methyl cyclohexane	UG/KG	5	10%		0	10	98					
Methyl ethyl ketone	UG/KG	190	12%	300	0	22	177	11 U	11 U	12 U	11 U	12 U
Methyl isobutyl ketone	UG/KG	1.9	1%	1000	0	1	177	11 U	11 U	12 U	11 U	12 U
Methylene chloride	UG/KG	4.9	20%	100	0	36	178	5.7 U	5.6 U	5.9 U	5.7 U	5.9 U
Ortho Xylene	UG/KG	5.05	4%		0	3	70	1.1 NJ	5.6 U	5.9 U	5.7 U	5.9 U

Table A-2A
SURFACE SOIL SAMPLE RESULTS (0-2 ft.)
SEAD-59
SEAD-59 and SEAD-71 Phase II RI Report
Seneca Army Depot Activity

Facility	SEAD-59	SEAD-59	SEAD-59	SEAD-59	SEAD-59
Location ID	WS-59-01-006-4	WS-59-01-006-5	WS-59-01-006-6	WS-59-01-006-8	WS-59-01-007-3
Matrix	SOIL	SOIL	SOIL	SOIL	SOIL
Sample ID	WS-59-01-006-4	WS-59-01-006-5	WS-59-01-006-6	WS-59-01-006-8	WS-59-01-007-3
Sample Depth to Top of Sample ⁽¹⁾	0	0	0	0	0
Sample Depth to Bottom of Sample ⁽¹⁾	0	0	0	0	0
Sample Date	5/6/2004	5/6/2004	5/6/2004	5/6/2004	5/6/2004
QC Code	SA	SA	SA	SA	SA
Study ID	ENSR IRM	ENSR IRM	ENSR IRM	ENSR IRM	ENSR IRM
Sample Round	1	1	1	1	1

Parameter	Units	Maximum Value	Frequency of Detection	NYSDEC TAGM 4046 ⁽²⁾	Number of Exceedances	Number of Detects	Number of Analyses ⁽³⁾	Value (Q)	Value (Q)	Value (Q)	Value (Q)	Value (Q)
Styrene	UG/KG	0	0%		0	0	107					
Tetrachloroethene	UG/KG	6.4	3%	1400	0	5	177	5.7 U	5.6 U	5.9 U	5.7 U	5.9 U
Toluene	UG/KG	8	8%	1500	0	14	177	5.7 U	5.6 U	5.9 U	5.7 U	5.9 U
Total BTEX	MG/KG	3.25	67%		0	2	3					
Total Xylenes	UG/KG	3	7%	1200	0	7	102					
Trans-1,2-Dichloroethene	UG/KG	0	0%	300	0	0	168	5.7 U	5.6 U	5.9 U	5.7 U	5.9 U
Trans-1,3-Dichloropropene	UG/KG	0	0%		0	0	107					
Trichloroethene	UG/KG	4.5	5%	700	0	8	177	4.5 J	4 J	5.9 U	5.7 U	1.4 J
Trichlorofluoromethane	UG/KG	6	1%		0	1	98					
Vinyl chloride	UG/KG	0	0%	200	0	0	177	11 U	11 UJ	12 UJ	11 U	12 U
Semivolatile Organics												
1,1'-Biphenyl	UG/KG	254.5	2%		0	2	99					
1,2,4-Trichlorobenzene	UG/KG	0	0%	3400	0	0	9					
1,2-Dichlorobenzene	UG/KG	0	0%	7900	0	0	9					
1,3-Dichlorobenzene	UG/KG	0	0%	1600	0	0	9					
1,4-Dichlorobenzene	UG/KG	0	0%	8500	0	0	9					
2,2'-oxybis(1-Chloropropane)	UG/KG	0	0%		0	0	105					
2,4,5-Trichlorophenol	UG/KG	0	0%	100	0	0	178	1100 U	1100 U	1200 U	1900 U	2000 U
2,4,6-Trichlorophenol	UG/KG	0	0%		0	0	178	1100 U	1100 U	1200 U	1900 U	2000 U
2,4-Dichlorophenol	UG/KG	0	0%	400	0	0	178	1100 U	1100 U	1200 U	1900 U	2000 U
2,4-Dimethylphenol	UG/KG	0	0%		0	0	108					
2,4-Dinitrophenol	UG/KG	0	0%	200	0	0	178	5800 U	5700 U	6000 U	9600 U	10000 U
2,4-Dinitrotoluene	UG/KG	0	0%		0	0	178	1100 U	1100 U	1200 U	1900 U	2000 U
2,6-Dinitrotoluene	UG/KG	0	0%	1000	0	0	178	1100 U	1100 U	1200 U	1900 U	2000 U
2-Chloronaphthalene	UG/KG	0	0%		0	0	108					
2-Chlorophenol	UG/KG	0	0%	800	0	0	178	1100 U	1100 U	1200 U	1900 U	2000 U
2-Methylnaphthalene	UG/KG	1295	19%	36400	0	34	178	280 J	1100 U	1200 U	1900 U	2000 U
2-Methylphenol	UG/KG	0	0%	100	0	0	178	1100 U	1100 U	1200 U	1900 U	2000 U
2-Nitroaniline	UG/KG	0	0%	430	0	0	178	5800 U	5700 U	6000 U	9600 U	10000 U
2-Nitrophenol	UG/KG	0	0%	330	0	0	178	1100 U	1100 U	1200 U	1900 U	2000 U
3,3'-Dichlorobenzidine	UG/KG	0	0%		0	0	178	1100 U	1100 U	1200 U	1900 U	2000 U
3-Nitroaniline	UG/KG	0	0%	500	0	0	178	5800 U	5700 U	6000 U	9600 U	10000 U
4,6-Dinitro-2-methylphenol	UG/KG	0	0%		0	0	108					
4-Bromophenyl phenyl ether	UG/KG	0	0%		0	0	108					
4-Chloro-3-methylphenol	UG/KG	0	0%	240	0	0	178	1100 U	1100 U	1200 U	1900 U	2000 U
4-Chloroaniline	UG/KG	1200	1%	220	1	2	178	1100 U	1100 U	1200 U	1900 U	2000 U
4-Chlorophenyl phenyl ether	UG/KG	0	0%		0	0	108					
4-Methylphenol	UG/KG	150	3%	900	0	5	178	1100 U	1100 U	1200 U	1900 U	2000 U
4-Nitroaniline	UG/KG	0	0%		0	0	108					
4-Nitrophenol	UG/KG	0	0%	100	0	0	178	5800 U	5700 U	6000 U	9600 U	10000 U
Acenaphthene	UG/KG	2680	24%	50000	0	42	178	330 J	300 J	140 J	1900 U	260 J
Acenaphthylene	UG/KG	1700	37%	41000	0	66	178	1500	1600	650 J	1100 J	790 J
Acetophenone	UG/KG	0	0%		0	0	99					
Aniline	UG/KG	0	0%		0	0	70	1100 U	1100 U	1200 U	1900 U	2000 U
Anthracene	UG/KG	4395	43%	50000	0	77	178	1200	1300	580 J	900 J	920 J

Table A-2A
SURFACE SOIL SAMPLE RESULTS (0-2 ft.)
SEAD-59
SEAD-59 and SEAD-71 Phase II RI Report
Seneca Army Depot Activity

Facility	SEAD-59	SEAD-59	SEAD-59	SEAD-59	SEAD-59
Location ID	WS-59-01-006-4	WS-59-01-006-5	WS-59-01-006-6	WS-59-01-006-8	WS-59-01-007-3
Matrix	SOIL	SOIL	SOIL	SOIL	SOIL
Sample ID	WS-59-01-006-4	WS-59-01-006-5	WS-59-01-006-6	WS-59-01-006-8	WS-59-01-007-3
Sample Depth to Top of Sample ⁽¹⁾	0	0	0	0	0
Sample Depth to Bottom of Sample ⁽¹⁾	0	0	0	0	0
Sample Date	5/6/2004	5/6/2004	5/6/2004	5/6/2004	5/6/2004
QC Code	SA	SA	SA	SA	SA
Study ID	ENSR IRM	ENSR IRM	ENSR IRM	ENSR IRM	ENSR IRM
Sample Round	1	1	1	1	1

Parameter	Units	Maximum	Frequency of	NYSDEC	Number of	Number of	Number of	Value (Q)	Value (Q)	Value (Q)	Value (Q)	Value (Q)
		Value	Detection	TAGM 4046 ⁽²⁾	Exceedances	Detects	Analyses ⁽³⁾					
Atrazine	UG/KG	120	1%		0	1	99					
Benzaldehyde	UG/KG	50	1%		0	1	99					
Benzo(a)anthracene	UG/KG	8900	51%	224	72	90	178	2500	3100	1300	2000	3100
Benzo(a)pyrene	UG/KG	8050	51%	61	84	91	178	3100	3900	1600	2300	3200
Benzo(b)fluoranthene	UG/KG	6800	52%	1100	40	92	178	2200	2600	1100 J	1700 J	2500
Benzo(ghi)perylene	UG/KG	5200	46%	50000	0	82	178	2400	2900	1200	1900 J	2000
Benzo(k)fluoranthene	UG/KG	7350	49%	1100	35	88	178	2200	2800	1100 J	1500 J	2600
Benzoic Acid	UG/KG	0	0%	2700	0	0	70	5800 UJ	5700 UJ	6000 UJ	9600 UJ	10000 U
Bis(2-Chloroethoxy)methane	UG/KG	0	0%		0	0	108					
Bis(2-Chloroethyl)ether	UG/KG	0	0%		0	0	108					
Bis(2-Chloroisopropyl)ether	UG/KG	0	0%		0	0	3					
Bis(2-Ethylhexyl)phthalate	UG/KG	990	19%	50000	0	34	178	1100 U	1100 U	1200 U	1900 U	2000 U
Butylbenzylphthalate	UG/KG	0	0%	50000	0	0	178	1100 U	1100 U	1200 U	1900 U	2000 UJ
Caprolactam	UG/KG	0	0%		0	0	99					
Carbazole	UG/KG	755	19%		0	20	108					
Chrysene	UG/KG	8900	51%	400	62	91	178	2500	3100	1200	1900	3200
Di-n-butylphthalate	UG/KG	965	2%	8100	0	4	178	1100 U	1100 U	1200 U	1900 U	2000 U
Di-n-octylphthalate	UG/KG	0	0%	50000	0	0	178	1100 U	1100 U	1200 U	1900 U	2000 U
Dibenz(a,h)anthracene	UG/KG	1665	38%	14	67	68	178	710 J	940 J	400 J	510 J	710 J
Dibenzofuran	UG/KG	2350	16%	6200	0	28	178	180 NJ	120 J	1200 U	1900 U	2000 U
Diethyl phthalate	UG/KG	10	1%	7100	0	1	178	1100 U	1100 U	1200 U	1900 U	2000 U
Dimethylphthalate	UG/KG	0	0%	2000	0	0	178	1100 U	1100 U	1200 U	1900 U	2000 U
Fluoranthene	UG/KG	23500	54%	50000	0	97	178	4900	6200	2500	3900	6000
Fluorene	UG/KG	2640	28%	50000	0	49	178	430 J	310 J	190 J	220 J	310 J
Hexachlorobenzene	UG/KG	0	0%	410	0	0	178	1100 U	1100 U	1200 U	1900 U	2000 U
Hexachlorobutadiene	UG/KG	0	0%		0	0	178	1100 U	1100 U	1200 U	1900 U	2000 U
Hexachlorocyclopentadiene	UG/KG	0	0%		0	0	108					
Hexachloroethane	UG/KG	0	0%		0	0	178	1100 U	1100 U	1200 U	1900 U	2000 U
Indeno(1,2,3-cd)pyrene	UG/KG	4950	47%	3200	2	84	178	2000 J	2600 J	1100 J	1700 J	1900 J
Isophorone	UG/KG	0	0%	4400	0	0	178	1100 U	1100 U	1200 U	1900 U	2000 U
N-Nitrosodiphenylamine	UG/KG	100	1%		0	1	108					
N-Nitrosodipropylamine	UG/KG	0	0%		0	0	108					
Naphthalene	UG/KG	1800	19%	13000	0	34	178	170 J	110 NJ	1200 U	1900 U	2000 U
Nitrobenzene	UG/KG	0	0%	200	0	0	178	1100 U	1100 U	1200 U	1900 U	2000 U
Pentachlorophenol	UG/KG	0	0%	1000	0	0	178	5800 U	5700 U	6000 U	9600 U	10000 U
Phenanthrene	UG/KG	21300	51%	50000	0	90	178	2700	2800	1300	2000	2500
Phenol	UG/KG	0	0%	30	0	0	178	1100 U	1100 U	1200 U	1900 U	2000 U
Pyrene	UG/KG	19200	55%	50000	0	98	178	4900	5700	2200	3700	4900
Pyridine	UG/KG	0	0%		0	0	100	5800 U	5700 U	6000 U	9600 U	10000 U
Total Unknown PAHs as SV	MG/KG	25	100%		0	3	3					
Pesticides/PCBs												
4,4'-DDD	UG/KG	740	28%	2900	0	49	178	100 J	110	160	160	37
4,4'-DDE	UG/KG	2600	37%	2100	1	65	178	280	300	190	310	22 J
4,4'-DDT	UG/KG	3700	33%	2100	1	59	178	310	470	410	570	20 U
Aldrin	UG/KG	1.2	1%	41	0	1	178	9.6 U	19 U	20 U	39 U	10 U

**Table A-2A
SURFACE SOIL SAMPLE RESULTS (0-2 ft.)
SEAD-59
SEAD-59 and SEAD-71 Phase II RI Report
Seneca Army Depot Activity**

Facility	SEAD-59	SEAD-59	SEAD-59	SEAD-59	SEAD-59							
Location ID	WS-59-01-006-4	WS-59-01-006-5	WS-59-01-006-6	WS-59-01-006-8	WS-59-01-007-3							
Matrix	SOIL	SOIL	SOIL	SOIL	SOIL							
Sample ID	WS-59-01-006-4	WS-59-01-006-5	WS-59-01-006-6	WS-59-01-006-8	WS-59-01-007-3							
Sample Depth to Top of Sample ⁽¹⁾	0	0	0	0	0							
Sample Depth to Bottom of Sample ⁽¹⁾	0	0	0	0	0							
Sample Date	5/6/2004	5/6/2004	5/6/2004	5/6/2004	5/6/2004							
QC Code	SA	SA	SA	SA	SA							
Study ID	ENSR IRM	ENSR IRM	ENSR IRM	ENSR IRM	ENSR IRM							
Sample Round	1	1	1	1	1							
Parameter	Units	Maximum Value	Frequency of Detection	NYSDEC TAGM 4046 ⁽²⁾	Number of Exceedances	Number of Detects	Number of Analyses ⁽³⁾	Value (Q)	Value (Q)	Value (Q)	Value (Q)	Value (Q)
Alpha-BHC	UG/KG	0	0%	110	0	0	178	9.6 U	19 U	20 U	39 U	10 U
Alpha-Chlordane	UG/KG	34	4%		0	7	178	9.6 U	19 U	20 U	39 U	10 U
Beta-BHC	UG/KG	2.4	1%	200	0	1	178	9.6 U	19 U	20 U	39 U	10 U
Delta-BHC	UG/KG	0	0%	300	0	0	178	9.6 U	19 U	20 U	39 U	10 U
Dieldrin	UG/KG	0	0%	44	0	0	178	19 U	37 U	39 U	75 U	20 U
Endosulfan I	UG/KG	16	1%	900	0	1	178	9.6 U	19 U	20 U	39 U	10 U
Endosulfan II	UG/KG	0	0%	900	0	0	178	19 U	37 U	39 U	75 U	20 U
Endosulfan sulfate	UG/KG	6.2	1%	1000	0	1	178	19 U	37 U	39 U	75 U	20 U
Endrin	UG/KG	16	2%	100	0	3	178	19 U	37 U	39 U	75 U	20 U
Endrin aldehyde	UG/KG	4.9	1%		0	2	178	19 U	37 U	39 U	75 U	20 U
Endrin ketone	UG/KG	38	2%		0	4	178	19 U	37 U	39 U	75 U	20 U
Gamma-BHC/Lindane	UG/KG	0	0%	60	0	0	178	9.6 U	19 U	20 U	39 U	10 U
Gamma-Chlordane	UG/KG	24	8%	540	0	14	178	9.6 U	19 U	20 U	39 U	10 U
Heptachlor	UG/KG	0	0%	100	0	0	178	9.6 U	19 U	20 U	39 U	10 U
Heptachlor epoxide	UG/KG	3	1%	20	0	2	178	9.6 U	19 U	20 U	39 U	10 U
Methoxychlor	UG/KG	0	0%		0	0	178	96 U	190 U	200 U	390 U	100 U
Toxaphene	UG/KG	0	0%		0	0	178	190 U	370 U	390 U	750 U	200 U
Aroclor-1016	UG/KG	0	0%		0	0	178	37 U	37 U	39 U	37 U	39 U
Aroclor-1221	UG/KG	0	0%		0	0	178	37 U	37 U	39 U	37 U	39 U
Aroclor-1232	UG/KG	0	0%		0	0	178	37 U	37 U	39 U	37 U	39 U
Aroclor-1242	UG/KG	0	0%		0	0	178	37 U	37 U	39 U	37 U	39 U
Aroclor-1248	UG/KG	0	0%		0	0	178	37 U	37 U	39 U	37 U	39 U
Aroclor-1254	UG/KG	0	0%	10000	0	0	178	37 U	37 U	39 U	37 U	39 U
Aroclor-1260	UG/KG	79	1%	10000	0	2	178	37 U	37 U	39 U	37 U	39 U
Metals												
Aluminum	MG/KG	18300	100%	19300	0	178	178	10100	10600	11900	10000	10700
Antimony	MG/KG	424	58%	5.9	5	104	178	3.4 UJ	3.3 UJ	3.4 UJ	3.3 UJ	3.4 UJ
Arsenic	MG/KG	32.2	100%	8.2	7	178	178	5.4	5.4 J	5.4 J	5.3 J	5
Barium	MG/KG	304	100%	300	1	178	178	84.8	85.1	105	85.4	87.5
Beryllium	MG/KG	2.6	99%	1.1	2	176	178	0.2	0.26	0.23	0.23	0.29
Cadmium	MG/KG	3.2	86%	2.3	2	153	178	0.61	0.68	0.68	0.7	0.7
Calcium	MG/KG	214000	100%	121000	1	178	178	53600	63500	37100	63200	44700
Chromium	MG/KG	39.3	100%	29.6	2	178	178	19.4	19	20.3	18.1	19.4
Cobalt	MG/KG	47.8	100%	30	2	178	178	10.5	11	11.2	9.9	9.5
Copper	MG/KG	305	100%	33	19	178	178	27.6	33.6 J	46.9 J	33.5 J	29.2
Cyanide	MG/KG	0	0%	0.35	0	0	9					
Iron	MG/KG	64000	100%	36500	1	178	178	19200	18900	20800	18400	19400
Lead	MG/KG	164	100%	24.8	75	178	178	54.9	58.1	48.7	164	39.8 J
Magnesium	MG/KG	30200	100%	21500	3	178	178	8380	8610	6890	9330	7980
Manganese	MG/KG	1290	100%	1060	3	178	178	529	522	575	462	451
Mercury	MG/KG	0.95	95%	0.1	37	169	178	0.05	0.11	0.23	0.05	0.08
Nickel	MG/KG	88.3	100%	49	3	178	178	28.6	30.7	30.7	27.4	28.7
Potassium	MG/KG	2290	100%	2380	0	178	178	1100	1100	1180	1090	1100
Selenium	MG/KG	1.5	9%	2	0	16	178	0.56 UJ	0.55 U	0.57 U	0.56 U	0.57 U
Silver	MG/KG	2.9	49%	0.75	62	87	178	0.56 U	0.55 UJ	0.57 UJ	0.56 UJ	0.57 UJ

**Table A-2A
SURFACE SOIL SAMPLE RESULTS (0-2 ft.)
SEAD-59
SEAD-59 and SEAD-71 Phase II RI Report
Seneca Army Depot Activity**

Facility	SEAD-59	SEAD-59	SEAD-59	SEAD-59	SEAD-59
Location ID	WS-59-01-006-4	WS-59-01-006-5	WS-59-01-006-6	WS-59-01-006-8	WS-59-01-007-3
Matrix	SOIL	SOIL	SOIL	SOIL	SOIL
Sample ID	WS-59-01-006-4	WS-59-01-006-5	WS-59-01-006-6	WS-59-01-006-8	WS-59-01-007-3
Sample Depth to Top of Sample ⁽¹⁾	0	0	0	0	0
Sample Depth to Bottom of Sample ⁽¹⁾	0	0	0	0	0
Sample Date	5/6/2004	5/6/2004	5/6/2004	5/6/2004	5/6/2004
QC Code	SA	SA	SA	SA	SA
Study ID	ENSR IRM	ENSR IRM	ENSR IRM	ENSR IRM	ENSR IRM
Sample Round	1	1	1	1	1

Parameter	Units	Maximum Value	Frequency of Detection	NYSDEC TAGM 4046 ⁽²⁾	Number of Exceedances	Number of Detects	Number of Analyses ⁽³⁾	Value (Q)	Value (Q)	Value (Q)	Value (Q)	Value (Q)
Sodium	MG/KG	4060	99%	172	86	177	178	105	173	222	194	461
Thallium	MG/KG	1.8	29%	0.7	24	51	178	0.64 J	0.78 J	0.75 J	0.56 U	0.67 J
Vanadium	MG/KG	28.5	100%	150	0	178	178	18.1	18.5	20.4	19.4	18.5
Zinc	MG/KG	341	100%	110	19	178	178	104	114 J	115 J	135 J	133

Note(s):

- (1) - Historical sample depths are presented (I.e. prior to 2002 TCRA)
- (2) - NYSDEC Technical and Administrative Guidance Memorandum (TAGM) HWR-94-4046, Revised January 24, 1994
- (3) - Sample/Duplicate pair are presented as individual samples in this table. Statistical information used Sample Duplicate pairs as a single entity and averaged result values were used in risk assessment analysis.

U = compound was not detected

J = the reported value is an estimated concentration

UJ = the compound was not detected; the associated reporting limit is approximate

R = the data was rejected in the data validating process

NJ = compound was "tentatively identified" and the associated numerical value is approximate

Table A-2A
SURFACE SOIL SAMPLE RESULTS (0-2 ft.)
SEAD-59
SEAD-59 and SEAD-71 Phase II RI Report
Seneca Army Depot Activity

Facility	SEAD-59	SEAD-59	SEAD-59	SEAD-59	SEAD-59
Location ID	WS-59-01-007-4	WS-59-01-007-7	WS-59-01-007-9	WS-59-01-011-3	WS-59-01-011-4
Matrix	SOIL	SOIL	SOIL	SOIL	SOIL
Sample ID	WS-59-01-007-4	WS-59-01-007-7	WS-59-01-007-9	WS-59-01-011-3	WS-59-01-011-4
Sample Depth to Top of Sample ⁽¹⁾	0	0	0	0	0
Sample Depth to Bottom of Sample ⁽¹⁾	0	0	0	0	0
Sample Date	5/6/2004	5/6/2004	5/6/2004	5/6/2004	5/6/2004
QC Code	SA	SA	SA	SA	SA
Study ID	ENSR IRM	ENSR IRM	ENSR IRM	ENSR IRM	ENSR IRM
Sample Round	1	1	1	1	1

Parameter	Units	Maximum Value	Frequency of Detection	NYSDEC TAGM 4046 ⁽²⁾	Number of Exceedances	Number of Detects	Number of Analyses ⁽³⁾	Value (Q)	Value (Q)	Value (Q)	Value (Q)	Value (Q)
Volatile Organics												
1,1,1-Trichloroethane	UG/KG	0	0%	800	0	0	177	5.9 U	6 U	5.8 U	5 U	5 U
1,1,2,2-Tetrachloroethane	UG/KG	0	0%	600	0	0	169	5.9 U	6 U	5.8 U	5 U	5 UJ
1,1,2-Trichloro-1,2,2-Trifluoroethane	UG/KG	0	0%		0	0	168	5.9 U	6 U	5.8 U	5 UJ	5 UJ
1,1,2-Trichloroethane	UG/KG	0	0%		0	0	107				5 U	5 U
1,1-Dichloroethane	UG/KG	0	0%	200	0	0	177	5.9 U	6 U	5.8 U	5 U	5 U
1,1-Dichloroethene	UG/KG	8	2%	400	0	3	177	5.9 U	6 U	5.8 U	5 U	5 U
1,2,3-Trichloropropane	UG/KG	0	0%		0	0	70	5.9 U	6 U	5.8 U		
1,2,4-Trichlorobenzene	UG/KG	0	0%	3400	0	0	161	5.9 U	6 U	5.8 U	5 U	5 UJ
1,2-Dibromo-3-chloropropane	UG/KG	0	0%		0	0	91				5 U	5 UJ
1,2-Dibromoethane	UG/KG	0	0%		0	0	98				5 U	5 U
1,2-Dichlorobenzene	UG/KG	0	0%	7900	0	0	161	5.9 U	6 U	5.8 U	5 U	5 UJ
1,2-Dichloroethane	UG/KG	0	0%	100	0	0	177	5.9 U	6 U	5.8 U	5 U	5 U
1,2-Dichloroethene (total)	UG/KG	0	0%		0	0	9					
1,2-Dichloropropane	UG/KG	0	0%		0	0	107				5 U	5 U
1,3-Dichlorobenzene	UG/KG	0	0%	1600	0	0	161	5.9 U	6 U	5.8 U	5 U	5 UJ
1,3-Dichloropropane	UG/KG	0	0%		0	0	70	5.9 U	6 U	5.8 U		
1,4-Dichlorobenzene	UG/KG	0	0%	8500	0	0	161	5.9 U	6 U	5.8 U	5 U	5 UJ
Acetone	UG/KG	550	27%	200	2	47	177	5.2 J	24 U	23 U	5 U	5 U
Benzene	UG/KG	3	4%	60	0	7	177	5.9 U	6 U	5.8 U	5 U	5 U
Bromodichloromethane	UG/KG	0	0%		0	0	107				5 U	5 U
Bromoform	UG/KG	0	0%		0	0	107				5 U	5 U
Carbon disulfide	UG/KG	4	3%	2700	0	6	177	5.9 U	6 U	5.8 U	5 U	5 U
Carbon tetrachloride	UG/KG	0	0%	600	0	0	177	5.9 U	6 U	5.8 U	5 U	5 U
Chlorobenzene	UG/KG	0	0%	1700	0	0	177	5.9 U	6 U	5.8 U	5 U	5 U
Chlorodibromomethane	UG/KG	0	0%		0	0	177	5.9 U	6 U	5.8 U	5 U	5 U
Chloroethane	UG/KG	0	0%	1900	0	0	177	12 U	12 U	12 U	5 U	5 U
Chloroform	UG/KG	0	0%	300	0	0	177	5.9 U	6 U	5.8 U	5 U	5 U
Cis-1,2-Dichloroethene	UG/KG	0	0%		0	0	98				5 U	5 U
Cis-1,3-Dichloropropene	UG/KG	0	0%		0	0	107				5 U	5 U
Cyclohexane	UG/KG	3	8%		0	8	98				5 U	5 U
Dichlorodifluoromethane	UG/KG	0	0%		0	0	98				5 U	5 U
Ethyl benzene	UG/KG	4.6	1%	5500	0	2	177	5.9 U	6 U	5.8 U	5 U	5 U
Isopropylbenzene	UG/KG	0	0%		0	0	98				5 U	5 U
Meta/Para Xylene	UG/KG	9.4	4%		0	3	70	5.9 U	6 U	5.8 U		
Methyl Acetate	UG/KG	2	3%		0	3	98				5 U	5 U
Methyl Tertbutyl Ether	UG/KG	0	0%		0	0	98				5 U	5 U
Methyl bromide	UG/KG	0	0%		0	0	107				5 U	5 U
Methyl butyl ketone	UG/KG	0	0%		0	0	107				5 U	5 U
Methyl chloride	UG/KG	0	0%		0	0	107				5 U	5 U
Methyl cyclohexane	UG/KG	5	10%		0	10	98				5 U	5 U
Methyl ethyl ketone	UG/KG	190	12%	300	0	22	177	12 U	12 U	12 U	5 U	5 U
Methyl isobutyl ketone	UG/KG	1.9	1%	1000	0	1	177	12 U	12 U	12 U	5 U	5 U
Methylene chloride	UG/KG	4.9	20%	100	0	36	178	5.9 U	6 U	5.8 U	5 U	2 J
Ortho Xylene	UG/KG	5.05	4%		0	3	70	5.9 U	6 U	5.8 U		

Table A-2A
SURFACE SOIL SAMPLE RESULTS (0-2 ft.)
SEAD-59
SEAD-59 and SEAD-71 Phase II RI Report
Seneca Army Depot Activity

Facility	SEAD-59	SEAD-59	SEAD-59	SEAD-59	SEAD-59
Location ID	WS-59-01-007-4	WS-59-01-007-7	WS-59-01-007-9	WS-59-01-011-3	WS-59-01-011-4
Matrix	SOIL	SOIL	SOIL	SOIL	SOIL
Sample ID	WS-59-01-007-4	WS-59-01-007-7	WS-59-01-007-9	WS-59-01-011-3	WS-59-01-011-4
Sample Depth to Top of Sample ⁽¹⁾	0	0	0	0	0
Sample Depth to Bottom of Sample ⁽¹⁾	0	0	0	0	0
Sample Date	5/6/2004	5/6/2004	5/6/2004	5/6/2004	5/6/2004
QC Code	SA	SA	SA	SA	SA
Study ID	ENSR IRM	ENSR IRM	ENSR IRM	ENSR IRM	ENSR IRM
Sample Round	1	1	1	1	1

Parameter	Units	Maximum Value	Frequency of Detection	NYSDEC TAGM 4046 ⁽²⁾	Number of Exceedances	Number of Detects	Number of Analyses ⁽³⁾	Value (Q)	Value (Q)	Value (Q)	Value (Q)	Value (Q)
Styrene	UG/KG	0	0%		0	0	107				5 U	5 U
Tetrachloroethene	UG/KG	6.4	3%	1400	0	5	177	5.9 U	6 U	5.8 U	5 U	5 U
Toluene	UG/KG	8	8%	1500	0	14	177	5.9 U	6 U	5.8 U	5 U	5 U
Total BTEX	MG/KG	3.25	67%		0	2	3					
Total Xylenes	UG/KG	3	7%	1200	0	7	102				5 U	5 UJ
Trans-1,2-Dichloroethene	UG/KG	0	0%	300	0	0	168	5.9 U	6 U	5.8 U	5 U	5 U
Trans-1,3-Dichloropropene	UG/KG	0	0%		0	0	107				5 U	5 U
Trichloroethene	UG/KG	4.5	5%	700	0	8	177	2 J	6 U	2.6 J	5 U	5 U
Trichlorofluoromethane	UG/KG	6	1%		0	1	98				5 U	5 U
Vinyl chloride	UG/KG	0	0%	200	0	0	177	12 U	12 U	12 U	5 U	5 U
Semivolatile Organics												
1,1'-Biphenyl	UG/KG	254.5	2%		0	2	99				1900 U	1800 U
1,2,4-Trichlorobenzene	UG/KG	0	0%	3400	0	0	9					
1,2-Dichlorobenzene	UG/KG	0	0%	7900	0	0	9					
1,3-Dichlorobenzene	UG/KG	0	0%	1600	0	0	9					
1,4-Dichlorobenzene	UG/KG	0	0%	8500	0	0	9					
2,2'-oxybis(1-Chloropropane)	UG/KG	0	0%		0	0	105				1900 U	1800 U
2,4,5-Trichlorophenol	UG/KG	0	0%	100	0	0	178	1900 U	4000 U	1900 U	4800 U	4600 U
2,4,6-Trichlorophenol	UG/KG	0	0%		0	0	178	1900 U	4000 U	1900 U	1900 U	1800 U
2,4-Dichlorophenol	UG/KG	0	0%	400	0	0	178	1900 U	4000 U	1900 U	1900 U	1800 U
2,4-Dimethylphenol	UG/KG	0	0%		0	0	108				1900 U	1800 U
2,4-Dinitrophenol	UG/KG	0	0%	200	0	0	178	10000 U	20000 U	9900 U	4800 U	4600 U
2,4-Dinitrotoluene	UG/KG	0	0%		0	0	178	1900 U	4000 U	1900 U	1900 U	1800 U
2,6-Dinitrotoluene	UG/KG	0	0%	1000	0	0	178	1900 U	4000 U	1900 U	1900 U	1800 U
2-Chloronaphthalene	UG/KG	0	0%		0	0	108				1900 U	1800 U
2-Chlorophenol	UG/KG	0	0%	800	0	0	178	1900 U	4000 U	1900 U	1900 U	1800 U
2-Methylnaphthalene	UG/KG	1295	19%	36400	0	34	178	1900 U	4000 U	340 J	1900 U	1800 U
2-Methylphenol	UG/KG	0	0%	100	0	0	178	1900 U	4000 U	1900 U	1900 U	1800 U
2-Nitroaniline	UG/KG	0	0%	430	0	0	178	10000 U	20000 U	9900 U	4800 U	4600 U
2-Nitrophenol	UG/KG	0	0%	330	0	0	178	1900 U	4000 U	1900 U	1900 U	1800 U
3,3'-Dichlorobenzidine	UG/KG	0	0%		0	0	178	1900 U	4000 U	1900 U	1900 U	1800 U
3-Nitroaniline	UG/KG	0	0%	500	0	0	178	10000 U	20000 U	9900 U	4800 U	4600 U
4,6-Dinitro-2-methylphenol	UG/KG	0	0%		0	0	108				4800 U	4600 U
4-Bromophenyl phenyl ether	UG/KG	0	0%		0	0	108				1900 U	1800 U
4-Chloro-3-methylphenol	UG/KG	0	0%	240	0	0	178	1900 U	4000 U	1900 U	1900 U	1800 U
4-Chloroaniline	UG/KG	1200	1%	220	1	2	178	1900 U	4000 U	1900 U	1900 U	1800 U
4-Chlorophenyl phenyl ether	UG/KG	0	0%		0	0	108				1900 U	1800 U
4-Methylphenol	UG/KG	150	3%	900	0	5	178	1900 U	4000 U	1900 U	1900 U	1800 U
4-Nitroaniline	UG/KG	0	0%		0	0	108				4800 U	4600 U
4-Nitrophenol	UG/KG	0	0%	100	0	0	178	10000 U	20000 U	9900 U	4800 U	4600 U
Acenaphthene	UG/KG	2680	24%	50000	0	42	178	1900 U	4000 U	590 J	1900 U	1800 U
Acenaphthylene	UG/KG	1700	37%	41000	0	66	178	850 J	690 J	740 J	900 J	710 J
Acetophenone	UG/KG	0	0%		0	0	99				1900 U	1800 U
Aniline	UG/KG	0	0%		0	0	70	1900 U	4000 U	1900 U		
Anthracene	UG/KG	4395	43%	50000	0	77	178	730 J	810 J	1400 J	750 J	640 J

**Table A-2A
SURFACE SOIL SAMPLE RESULTS (0-2 ft.)
SEAD-59
SEAD-59 and SEAD-71 Phase II RI Report
Seneca Army Depot Activity**

Facility	SEAD-59	SEAD-59	SEAD-59	SEAD-59	SEAD-59
Location ID	WS-59-01-007-4	WS-59-01-007-7	WS-59-01-007-9	WS-59-01-011-3	WS-59-01-011-4
Matrix	SOIL	SOIL	SOIL	SOIL	SOIL
Sample ID	WS-59-01-007-4	WS-59-01-007-7	WS-59-01-007-9	WS-59-01-011-3	WS-59-01-011-4
Sample Depth to Top of Sample ⁽¹⁾	0	0	0	0	0
Sample Depth to Bottom of Sample ⁽¹⁾	0	0	0	0	0
Sample Date	5/6/2004	5/6/2004	5/6/2004	5/6/2004	5/6/2004
QC Code	SA	SA	SA	SA	SA
Study ID	ENSR IRM	ENSR IRM	ENSR IRM	ENSR IRM	ENSR IRM
Sample Round	1	1	1	1	1

Parameter	Units	Maximum Value	Frequency of Detection	NYSDEC TAGM 4046 ⁽²⁾	Number of Exceedances	Number of Detects	Number of Analyses ⁽³⁾	Value (Q)	Value (Q)	Value (Q)	Value (Q)	Value (Q)
Atrazine	UG/KG	120	1%		0	1	99				1900 U	1800 U
Benzaldehyde	UG/KG	50	1%		0	1	99				1900 U	1800 U
Benzo(a)anthracene	UG/KG	8900	51%	224	72	90	178	2000 J	2200 J	2900	2600	2200
Benzo(a)pyrene	UG/KG	8050	51%	61	84	91	178	2400	2500 J	3000	3000	2500
Benzo(b)fluoranthene	UG/KG	6800	52%	1100	40	92	178	1800 J	2000 J	2100	3500	2900
Benzo(ghi)perylene	UG/KG	5200	46%	50000	0	82	178	1600 J	1200 J	2000	1900	1600 J
Benzo(k)fluoranthene	UG/KG	7350	49%	1100	35	88	178	1800 J	2000 J	2400	1500 J	1100 J
Benzoic Acid	UG/KG	0	0%	2700	0	0	70	10000 U	20000 U	9900 U		
Bis(2-Chloroethoxy)methane	UG/KG	0	0%		0	0	108				1900 U	1800 U
Bis(2-Chloroethyl)ether	UG/KG	0	0%		0	0	108				1900 U	1800 U
Bis(2-Chloroisopropyl)ether	UG/KG	0	0%		0	0	3					
Bis(2-Ethylhexyl)phthalate	UG/KG	990	19%	50000	0	34	178	1900 U	4000 U	1900 U	1900 U	1800 U
Butylbenzylphthalate	UG/KG	0	0%	50000	0	0	178	1900 UJ	4000 UJ	1900 U	1900 U	1800 U
Caprolactam	UG/KG	0	0%		0	0	99				1900 U	1800 U
Carbazole	UG/KG	755	19%		0	20	108				1900 U	1800 U
Chrysene	UG/KG	8900	51%	400	62	91	178	2000	2200 J	2900	2500	2100
Di-n-butylphthalate	UG/KG	965	2%	8100	0	4	178	1900 U	4000 U	1900 U	1900 U	1800 U
Di-n-octylphthalate	UG/KG	0	0%	50000	0	0	178	1900 U	4000 U	1900 U	1900 U	1800 U
Dibenz(a,h)anthracene	UG/KG	1665	38%	14	67	68	178	510 J	460 J	640 J	520 J	410 J
Dibenzofuran	UG/KG	2350	16%	6200	0	28	178	1900 U	4000 U	400 J	1900 U	1800 U
Diethyl phthalate	UG/KG	10	1%	7100	0	1	178	1900 U	4000 U	1900 U	1900 U	1800 U
Dimethylphthalate	UG/KG	0	0%	2000	0	0	178	1900 U	4000 U	1900 U	1900 U	1800 U
Fluoranthene	UG/KG	23500	54%	50000	0	97	178	3700	4400	5600	3600	3100
Fluorene	UG/KG	2640	28%	50000	0	49	178	1900 U	4000 U	690 J	1900 U	1800 U
Hexachlorobenzene	UG/KG	0	0%	410	0	0	178	1900 U	4000 U	1900 U	1900 U	1800 U
Hexachlorobutadiene	UG/KG	0	0%		0	0	178	1900 U	4000 U	1900 U	1900 U	1800 U
Hexachlorocyclopentadiene	UG/KG	0	0%		0	0	108				1900 U	1800 U
Hexachloroethane	UG/KG	0	0%		0	0	178	1900 U	4000 U	1900 U	1900 U	1800 U
Indeno(1,2,3-cd)pyrene	UG/KG	4950	47%	3200	2	84	178	1500 J	1300 J	1800 J	1900	1600 J
Isophorone	UG/KG	0	0%	4400	0	0	178	1900 U	4000 U	1900 U	1900 U	1800 U
N-Nitrosodiphenylamine	UG/KG	100	1%		0	1	108				1900 U	1800 U
N-Nitrosodipropylamine	UG/KG	0	0%		0	0	108				1900 U	1800 U
Naphthalene	UG/KG	1800	19%	13000	0	34	178	1900 U	4000 U	690 J	1900 U	1800 U
Nitrobenzene	UG/KG	0	0%	200	0	0	178	1900 U	4000 U	1900 U	1900 U	1800 U
Pentachlorophenol	UG/KG	0	0%	1000	0	0	178	10000 U	20000 U	9900 U	4800 U	4600 U
Phenanthrene	UG/KG	21300	51%	50000	0	90	178	1800 J	1700 J	4000	1500 J	1300 J
Phenol	UG/KG	0	0%	30	0	0	178	1900 U	4000 U	1900 U	1900 U	1800 U
Pyrene	UG/KG	19200	55%	50000	0	98	178	3200	3200 J	5100	5000	4200
Pyridine	UG/KG	0	0%		0	0	100	10000 U	20000 U	9900 U		
Total Unknown PAHs as SV	MG/KG	25	100%		0	3	3					
Pesticides/PCBs												
4,4'-DDD	UG/KG	740	28%	2900	0	49	178	19 U	22	56	9 J	6.5 J
4,4'-DDE	UG/KG	2600	37%	2100	1	65	178	19 U	32	27	34 NJ	31 NJ
4,4'-DDT	UG/KG	3700	33%	2100	1	59	178	19 U	34	78	22	38 J
Aldrin	UG/KG	1.2	1%	41	0	1	178	10 U	10 U	9.9 U	2 U	1.8 U

**Table A-2A
SURFACE SOIL SAMPLE RESULTS (0-2 ft.)
SEAD-59
SEAD-59 and SEAD-71 Phase II RI Report
Seneca Army Depot Activity**

Facility	SEAD-59	SEAD-59	SEAD-59	SEAD-59	SEAD-59							
Location ID	WS-59-01-007-4	WS-59-01-007-7	WS-59-01-007-9	WS-59-01-011-3	WS-59-01-011-4							
Matrix	SOIL	SOIL	SOIL	SOIL	SOIL							
Sample ID	WS-59-01-007-4	WS-59-01-007-7	WS-59-01-007-9	WS-59-01-011-3	WS-59-01-011-4							
Sample Depth to Top of Sample ⁽¹⁾	0	0	0	0	0							
Sample Depth to Bottom of Sample ⁽¹⁾	0	0	0	0	0							
Sample Date	5/6/2004	5/6/2004	5/6/2004	5/6/2004	5/6/2004							
QC Code	SA	SA	SA	SA	SA							
Study ID	ENSR IRM	ENSR IRM	ENSR IRM	ENSR IRM	ENSR IRM							
Sample Round	1	1	1	1	1							
Parameter	Units	Maximum Value	Frequency of Detection	NYSDEC TAGM 4046 ⁽²⁾	Number of Exceedances	Number of Detects	Number of Analyses ⁽³⁾	Value (Q)	Value (Q)	Value (Q)	Value (Q)	Value (Q)
Alpha-BHC	UG/KG	0	0%	110	0	0	178	10 U	10 U	9.9 U	2 U	1.8 U
Alpha-Chlordane	UG/KG	34	4%		0	7	178	10 U	10 U	9.9 U	16	21
Beta-BHC	UG/KG	2.4	1%	200	0	1	178	10 U	10 U	9.9 U	2 U	1.8 U
Delta-BHC	UG/KG	0	0%	300	0	0	178	10 U	10 U	9.9 U	2 U	1.8 U
Dieldrin	UG/KG	0	0%	44	0	0	178	19 U	20 U	19 U	3.8 U	3.6 U
Endosulfan I	UG/KG	16	1%	900	0	1	178	10 U	10 U	9.9 U	2 U	1.8 U
Endosulfan II	UG/KG	0	0%	900	0	0	178	19 U	20 U	19 U	3.8 U	3.6 U
Endosulfan sulfate	UG/KG	6.2	1%	1000	0	1	178	19 U	20 U	19 U	3.8 U	3.6 U
Endrin	UG/KG	16	2%	100	0	3	178	19 U	20 U	19 U	3.8 U	3.6 U
Endrin aldehyde	UG/KG	4.9	1%		0	2	178	19 U	20 U	19 U	3.8 U	3.6 U
Endrin ketone	UG/KG	38	2%		0	4	178	19 U	20 U	19 U	38	11 NJ
Gamma-BHC/Lindane	UG/KG	0	0%	60	0	0	178	10 U	10 U	9.9 U	2 U	1.8 U
Gamma-Chlordane	UG/KG	24	8%	540	0	14	178	10 U	10 U	9.9 U	7 J	11
Heptachlor	UG/KG	0	0%	100	0	0	178	10 U	10 U	9.9 U	2 U	1.8 U
Heptachlor epoxide	UG/KG	3	1%	20	0	2	178	10 U	10 U	9.9 U	2 U	1.8 U
Methoxychlor	UG/KG	0	0%		0	0	178	100 U	100 U	99 U	20 UJ	18 UJ
Toxaphene	UG/KG	0	0%		0	0	178	190 U	200 U	190 U	200 U	180 U
Aroclor-1016	UG/KG	0	0%		0	0	178	39 U	40 U	38 U	38 U	36 U
Aroclor-1221	UG/KG	0	0%		0	0	178	39 U	40 U	38 U	38 U	36 U
Aroclor-1232	UG/KG	0	0%		0	0	178	39 U	40 U	38 U	38 U	36 U
Aroclor-1242	UG/KG	0	0%		0	0	178	39 U	40 U	38 U	38 U	36 U
Aroclor-1248	UG/KG	0	0%		0	0	178	39 U	40 U	38 U	38 U	36 U
Aroclor-1254	UG/KG	0	0%	10000	0	0	178	39 U	40 U	38 U	38 U	36 U
Aroclor-1260	UG/KG	79	1%	10000	0	2	178	39 U	40 U	38 U	38 U	36 U
Metals												
Aluminum	MG/KG	18300	100%	19300	0	178	178	10900	10900	11100	11200 J	11300 J
Antimony	MG/KG	424	58%	5.9	5	104	178	3.4 UJ	3.4 UJ	3.5 UJ	2.7 J	8.9 J
Arsenic	MG/KG	32.2	100%	8.2	7	178	178	4.7	4.2	4.7	6.8 J	6.4 J
Barium	MG/KG	304	100%	300	1	178	178	91.3	97	90.7	94.2 J	90.5 J
Beryllium	MG/KG	2.6	99%	1.1	2	176	178	0.29	0.35	0.32	0.6	0.57
Cadmium	MG/KG	3.2	86%	2.3	2	153	178	0.8	0.64	0.7	0.47	0.52
Calcium	MG/KG	214000	100%	121000	1	178	178	56100	32500	36400	41000	62300
Chromium	MG/KG	39.3	100%	29.6	2	178	178	20	20	19.1	17.1 J	17.3 J
Cobalt	MG/KG	47.8	100%	30	2	178	178	9.9	9.5	9.9	10.1 J	9 J
Copper	MG/KG	305	100%	33	19	178	178	38.8	39.9	28.4	25.8 J	99.7 J
Cyanide	MG/KG	0	0%	0.35	0	0	9					
Iron	MG/KG	64000	100%	36500	1	178	178	19500	19000	20200	22100	20400
Lead	MG/KG	164	100%	24.8	75	178	178	53.6 J	38.2 J	44.6 J	36.6 J	61.8 J
Magnesium	MG/KG	30200	100%	21500	3	178	178	9650	6370	7130	6430 J	8940 J
Manganese	MG/KG	1290	100%	1060	3	178	178	507	408	512	516 J	463 J
Mercury	MG/KG	0.95	95%	0.1	37	169	178	0.12	0.07	0.07	0.07	0.06
Nickel	MG/KG	88.3	100%	49	3	178	178	28.9	30	28.9	27 J	26 J
Potassium	MG/KG	2290	100%	2380	0	178	178	1110	1140	1140	1110 J	1580 J
Selenium	MG/KG	1.5	9%	2	0	16	178	0.57 U	0.57 U	0.58 U	0.43 U	0.45 U
Silver	MG/KG	2.9	49%	0.75	62	87	178	0.57 UJ	0.57 UJ	0.58 UJ	0.85	0.51 J

Table A-2A
SURFACE SOIL SAMPLE RESULTS (0-2 ft.)
SEAD-59
SEAD-59 and SEAD-71 Phase II RI Report
Seneca Army Depot Activity

Facility	SEAD-59	SEAD-59	SEAD-59	SEAD-59	SEAD-59
Location ID	WS-59-01-007-4	WS-59-01-007-7	WS-59-01-007-9	WS-59-01-011-3	WS-59-01-011-4
Matrix	SOIL	SOIL	SOIL	SOIL	SOIL
Sample ID	WS-59-01-007-4	WS-59-01-007-7	WS-59-01-007-9	WS-59-01-011-3	WS-59-01-011-4
Sample Depth to Top of Sample ⁽¹⁾	0	0	0	0	0
Sample Depth to Bottom of Sample ⁽¹⁾	0	0	0	0	0
Sample Date	5/6/2004	5/6/2004	5/6/2004	5/6/2004	5/6/2004
QC Code	SA	SA	SA	SA	SA
Study ID	ENSR IRM	ENSR IRM	ENSR IRM	ENSR IRM	ENSR IRM
Sample Round	1	1	1	1	1

Parameter	Units	Maximum Value	Frequency of Detection	NYSDEC TAGM 4046 ⁽²⁾	Number of Exceedances	Number of Detects	Number of Analyses ⁽³⁾	Value (Q)	Value (Q)	Value (Q)	Value (Q)	Value (Q)
Sodium	MG/KG	4060	99%	172	86	177	178	167	133	126	196J	383J
Thallium	MG/KG	1.8	29%	0.7	24	51	178	0.57 U	0.57 U	0.67 J	0.22 U	0.22 U
Vanadium	MG/KG	28.5	100%	150	0	178	178	19.5	19	20.5	18.1 J	19.9 J
Zinc	MG/KG	341	100%	110	19	178	178	92.4	104	91.6	84 J	83.5 J

Note(s):

- (1) - Historical sample depths are presented (I.e. prior to 2002 TCRA)
- (2) - NYSDEC Technical and Administrative Guidance Memorandum (TAGM) HWR-94-4046, Revised January 24, 1994
- (3) - Sample/Duplicate pair are presented as individual samples in this table. Statistical information used Sample Duplicate pairs as a single entity and averaged result values were used in risk assessment analysis.

U = compound was not detected
J = the reported value is an estimated concentration
UJ = the compound was not detected; the associated reporting limit is approximate
R = the data was rejected in the data validating process
NJ = compound was "tentatively identified" and the associated numerical value is approximate

**Table A-2A
SURFACE SOIL SAMPLE RESULTS (0-2 ft.)
SEAD-59
SEAD-59 and SEAD-71 Phase II RI Report
Seneca Army Depot Activity**

Facility	SEAD-59	SEAD-59	SEAD-59	SEAD-59	SEAD-59
Location ID	WS-59-01-013-1	WS-59-01-013-3	WS-59-01-013-4	WS-59-01-013-5	WS-59-01-013-6
Matrix	SOIL	SOIL	SOIL	SOIL	SOIL
Sample ID	WS-59-01-013-1	WS-59-01-013-3	WS-59-01-013-4	WS-59-01-013-5	WS-59-01-013-6
Sample Depth to Top of Sample ⁽¹⁾	0	0	0	0	0
Sample Depth to Bottom of Sample ⁽¹⁾	0	0	0	0	0
Sample Date	5/6/2004	5/6/2004	5/6/2004	5/6/2004	5/6/2004
QC Code	SA	SA	SA	SA	SA
Study ID	ENSR IRM	ENSR IRM	ENSR IRM	ENSR IRM	ENSR IRM
Sample Round	1	1	1	1	1

Parameter	Units	Maximum Value	Frequency of Detection	NYSDEC TAGM 4046 ⁽²⁾	Number of Exceedances	Number of Detects	Number of Analyses ⁽³⁾	Value (Q)	Value (Q)	Value (Q)	Value (Q)	Value (Q)
Volatile Organics												
1,1,1-Trichloroethane	UG/KG	0	0%	800	0	0	177	5.8 U	5.8 U	5.9 U	5.8 U	5.8 U
1,1,2,2-Tetrachloroethane	UG/KG	0	0%	600	0	0	169	5.8 U	5.8 U	5.9 U	5.8 U	5.8 U
1,1,2-Trichloro-1,2,2-Trifluoroethane	UG/KG	0	0%		0	0	168	5.8 U	5.8 U	5.9 U	5.8 U	5.8 U
1,1,2-Trichloroethane	UG/KG	0	0%		0	0	107					
1,1-Dichloroethane	UG/KG	0	0%	200	0	0	177	5.8 U	5.8 U	5.9 U	5.8 U	5.8 U
1,1-Dichloroethene	UG/KG	8	2%	400	0	3	177	5.8 U	5.8 U	5.9 U	5.8 U	5.8 U
1,2,3-Trichloropropane	UG/KG	0	0%		0	0	70	5.8 U	5.8 U	5.9 U	5.8 U	5.8 U
1,2,4-Trichlorobenzene	UG/KG	0	0%	3400	0	0	161	5.8 U	5.8 U	5.9 U	5.8 U	5.8 U
1,2-Dibromo-3-chloropropane	UG/KG	0	0%		0	0	91					
1,2-Dibromoethane	UG/KG	0	0%		0	0	98					
1,2-Dichlorobenzene	UG/KG	0	0%	7900	0	0	161	5.8 U	5.8 U	5.9 U	5.8 U	5.8 U
1,2-Dichloroethane	UG/KG	0	0%	100	0	0	177	5.8 U	5.8 U	5.9 U	5.8 U	5.8 U
1,2-Dichloroethene (total)	UG/KG	0	0%		0	0	9					
1,2-Dichloropropane	UG/KG	0	0%		0	0	107					
1,3-Dichlorobenzene	UG/KG	0	0%	1600	0	0	161	5.8 U	5.8 U	5.9 U	5.8 U	5.8 U
1,3-Dichloropropane	UG/KG	0	0%		0	0	70	5.8 U	5.8 U	5.9 U	5.8 U	5.8 U
1,4-Dichlorobenzene	UG/KG	0	0%	8500	0	0	161	5.8 U	5.8 U	5.9 U	5.8 U	5.8 U
Acetone	UG/KG	550	27%	200	2	47	177	23 U	23 U	24 U	23 U	23 U
Benzene	UG/KG	3	4%	60	0	7	177	5.8 U	5.8 U	5.9 U	5.8 U	5.8 U
Bromodichloromethane	UG/KG	0	0%		0	0	107					
Bromoform	UG/KG	0	0%		0	0	107					
Carbon disulfide	UG/KG	4	3%	2700	0	6	177	5.8 U	5.8 U	5.9 U	5.8 U	5.8 U
Carbon tetrachloride	UG/KG	0	0%	600	0	0	177	5.8 U	5.8 U	5.9 U	5.8 U	5.8 U
Chlorobenzene	UG/KG	0	0%	1700	0	0	177	5.8 U	5.8 U	5.9 U	5.8 U	5.8 U
Chlorodibromomethane	UG/KG	0	0%		0	0	177	5.8 U	5.8 U	5.9 U	5.8 U	5.8 U
Chloroethane	UG/KG	0	0%	1900	0	0	177	12 U	12 U	12 U	12 U	12 U
Chloroform	UG/KG	0	0%	300	0	0	177	5.8 U	5.8 U	5.9 U	5.8 U	5.8 U
Cis-1,2-Dichloroethene	UG/KG	0	0%		0	0	98					
Cis-1,3-Dichloropropene	UG/KG	0	0%		0	0	107					
Cyclohexane	UG/KG	3	8%		0	8	98					
Dichlorodifluoromethane	UG/KG	0	0%		0	0	98					
Ethyl benzene	UG/KG	4.6	1%	5500	0	2	177	5.8 U	5.8 U	5.9 U	5.8 U	5.8 U
Isopropylbenzene	UG/KG	0	0%		0	0	98					
Meta/Para Xylene	UG/KG	9.4	4%		0	3	70	5.8 U	5.8 U	5.9 U	5.8 U	5.8 U
Methyl Acetate	UG/KG	2	3%		0	3	98					
Methyl Tertbutyl Ether	UG/KG	0	0%		0	0	98					
Methyl bromide	UG/KG	0	0%		0	0	107					
Methyl butyl ketone	UG/KG	0	0%		0	0	107					
Methyl chloride	UG/KG	0	0%		0	0	107					
Methyl cyclohexane	UG/KG	5	10%		0	10	98					
Methyl ethyl ketone	UG/KG	190	12%	300	0	22	177	12 U	12 U	12 U	12 U	12 U
Methyl isobutyl ketone	UG/KG	1.9	1%	1000	0	1	177	12 U	12 U	12 U	12 U	12 U
Methylene chloride	UG/KG	4.9	20%	100	0	36	178	5.8 U	5.8 U	5.9 U	1.3 J	5.8 U
Ortho Xylene	UG/KG	5.05	4%		0	3	70	5.8 U	5.8 U	5.9 U	5.8 U	5.8 U

**Table A-2A
SURFACE SOIL SAMPLE RESULTS (0-2 ft.)
SEAD-59
SEAD-59 and SEAD-71 Phase II RI Report
Seneca Army Depot Activity**

Facility	SEAD-59	SEAD-59	SEAD-59	SEAD-59	SEAD-59
Location ID	WS-59-01-013-1	WS-59-01-013-3	WS-59-01-013-4	WS-59-01-013-5	WS-59-01-013-6
Matrix	SOIL	SOIL	SOIL	SOIL	SOIL
Sample ID	WS-59-01-013-1	WS-59-01-013-3	WS-59-01-013-4	WS-59-01-013-5	WS-59-01-013-6
Sample Depth to Top of Sample ⁽¹⁾	0	0	0	0	0
Sample Depth to Bottom of Sample ⁽¹⁾	0	0	0	0	0
Sample Date	5/6/2004	5/6/2004	5/6/2004	5/6/2004	5/6/2004
QC Code	SA	SA	SA	SA	SA
Study ID	ENSR IRM	ENSR IRM	ENSR IRM	ENSR IRM	ENSR IRM
Sample Round	1	1	1	1	1

Parameter	Units	Maximum Value	Frequency of Detection	NYSDEC TAGM 4046 ⁽²⁾	Number of Exceedances	Number of Detects	Number of Analyses ⁽³⁾	Value (Q)	Value (Q)	Value (Q)	Value (Q)	Value (Q)
Styrene	UG/KG	0	0%		0	0	107					
Tetrachloroethene	UG/KG	6.4	3%	1400	0	5	177	5.8 U	5.8 U	5.9 U	5.8 U	5.8 U
Toluene	UG/KG	8	8%	1500	0	14	177	5.8 U	5.8 U	5.9 U	5.8 U	5.8 U
Total BTEX	MG/KG	3.25	67%		0	2	3					
Total Xylenes	UG/KG	3	7%	1200	0	7	102					
Trans-1,2-Dichloroethene	UG/KG	0	0%	300	0	0	168	5.8 U	5.8 U	5.9 U	5.8 U	5.8 U
Trans-1,3-Dichloropropene	UG/KG	0	0%		0	0	107					
Trichloroethene	UG/KG	4.5	5%	700	0	8	177	5.8 U	5.8 U	5.9 U	5.8 U	5.8 U
Trichlorofluoromethane	UG/KG	6	1%		0	1	98					
Vinyl chloride	UG/KG	0	0%	200	0	0	177	12 U	12 U	12 U	12 U	12 U
Semivolatile Organics												
1,1'-Biphenyl	UG/KG	254.5	2%		0	2	99					
1,2,4-Trichlorobenzene	UG/KG	0	0%	3400	0	0	9					
1,2-Dichlorobenzene	UG/KG	0	0%	7900	0	0	9					
1,3-Dichlorobenzene	UG/KG	0	0%	1600	0	0	9					
1,4-Dichlorobenzene	UG/KG	0	0%	8500	0	0	9					
2,2'-oxybis(1-Chloropropane)	UG/KG	0	0%		0	0	105					
2,4,5-Trichlorophenol	UG/KG	0	0%	100	0	0	178	1900 U	1900 U	780 U	1900 U	1900 U
2,4,6-Trichlorophenol	UG/KG	0	0%		0	0	178	1900 U	1900 U	780 U	1900 U	1900 U
2,4-Dichlorophenol	UG/KG	0	0%	400	0	0	178	1900 U	1900 U	780 U	1900 U	1900 U
2,4-Dimethylphenol	UG/KG	0	0%		0	0	108					
2,4-Dinitrophenol	UG/KG	0	0%	200	0	0	178	9900 U	9900 U	4000 U	9900 U	9800 U
2,4-Dinitrotoluene	UG/KG	0	0%		0	0	178	1900 U	1900 U	780 U	1900 U	1900 U
2,6-Dinitrotoluene	UG/KG	0	0%	1000	0	0	178	1900 U	1900 U	780 U	1900 U	1900 U
2-Chloronaphthalene	UG/KG	0	0%		0	0	108					
2-Chlorophenol	UG/KG	0	0%	800	0	0	178	1900 U	1900 U	780 U	1900 U	1900 U
2-Methylnaphthalene	UG/KG	1295	19%	36400	0	34	178	370 J	260 J	780 U	1900 U	1900 U
2-Methylphenol	UG/KG	0	0%	100	0	0	178	1900 U	1900 U	780 U	1900 U	1900 U
2-Nitroaniline	UG/KG	0	0%	430	0	0	178	9900 U	9900 U	4000 U	9900 U	9800 U
2-Nitrophenol	UG/KG	0	0%	330	0	0	178	1900 U	1900 U	780 U	1900 U	1900 U
3,3'-Dichlorobenzidine	UG/KG	0	0%		0	0	178	1900 U	1900 U	780 U	1900 U	1900 U
3-Nitroaniline	UG/KG	0	0%	500	0	0	178	9900 U	9900 U	4000 U	9900 U	9800 U
4,6-Dinitro-2-methylphenol	UG/KG	0	0%		0	0	108					
4-Bromophenyl phenyl ether	UG/KG	0	0%		0	0	108					
4-Chloro-3-methylphenol	UG/KG	0	0%	240	0	0	178	1900 U	1900 U	780 U	1900 U	1900 U
4-Chloroaniline	UG/KG	1200	1%	220	1	2	178	1900 U	1900 U	780 U	1900 U	1900 U
4-Chlorophenyl phenyl ether	UG/KG	0	0%		0	0	108					
4-Methylphenol	UG/KG	150	3%	900	0	5	178	1900 U	1900 U	780 U	1900 U	1900 U
4-Nitroaniline	UG/KG	0	0%		0	0	108					
4-Nitrophenol	UG/KG	0	0%	100	0	0	178	9900 U	9900 U	4000 U	9900 U	9800 U
Acenaphthene	UG/KG	2680	24%	50000	0	42	178	850 J	370 J	110 J	1900 U	200 J
Acenaphthylene	UG/KG	1700	37%	41000	0	66	178	1400 J	620 J	330 J	470 J	540 J
Acetophenone	UG/KG	0	0%		0	0	99					
Aniline	UG/KG	0	0%		0	0	70	1900 U	1900 U	780 U	1900 U	1900 U
Anthracene	UG/KG	4395	43%	50000	0	77	178	3500	1100 J	370 J	510 J	720 J

Table A-2A
SURFACE SOIL SAMPLE RESULTS (0-2 ft.)
SEAD-59
SEAD-59 and SEAD-71 Phase II RI Report
Seneca Army Depot Activity

Facility	SEAD-59	SEAD-59	SEAD-59	SEAD-59	SEAD-59
Location ID	WS-59-01-013-1	WS-59-01-013-3	WS-59-01-013-4	WS-59-01-013-5	WS-59-01-013-6
Matrix	SOIL	SOIL	SOIL	SOIL	SOIL
Sample ID	WS-59-01-013-1	WS-59-01-013-3	WS-59-01-013-4	WS-59-01-013-5	WS-59-01-013-6
Sample Depth to Top of Sample ⁽¹⁾	0	0	0	0	0
Sample Depth to Bottom of Sample ⁽¹⁾	0	0	0	0	0
Sample Date	5/6/2004	5/6/2004	5/6/2004	5/6/2004	5/6/2004
QC Code	SA	SA	SA	SA	SA
Study ID	ENSR IRM	ENSR IRM	ENSR IRM	ENSR IRM	ENSR IRM
Sample Round	1	1	1	1	1

Parameter	Units	Maximum Value	Frequency of Detection	NYSDEC TAGM 4046 ⁽²⁾	Number of Exceedances	Number of Detects	Number of Analyses ⁽³⁾	Value (Q)	Value (Q)	Value (Q)	Value (Q)	Value (Q)
Atrazine	UG/KG	120	1%		0	1	99					
Benzaldehyde	UG/KG	50	1%		0	1	99					
Benzo(a)anthracene	UG/KG	8900	51%	224	72	90	178	7800	2800	1100	1600 J	2300
Benzo(a)pyrene	UG/KG	8050	51%	61	84	91	178	7000	2900	1400	2000	2700
Benzo(b)fluoranthene	UG/KG	6800	52%	1100	40	92	178	5200	2300	1100	1700 J	2100
Benzo(ghi)perylene	UG/KG	5200	46%	50000	0	82	178	3900	1800 J	1000	1500 J	2000
Benzo(k)fluoranthene	UG/KG	7350	49%	1100	35	88	178	5600	2500	1100	1600 J	2300
Benzoic Acid	UG/KG	0	0%	2700	0	0	70	9900 UJ	9900 UJ	4000 U	9900 UJ	9800 UJ
Bis(2-Chloroethoxy)methane	UG/KG	0	0%		0	0	108					
Bis(2-Chloroethyl)ether	UG/KG	0	0%		0	0	108					
Bis(2-Chloroisopropyl)ether	UG/KG	0	0%		0	0	3					
Bis(2-Ethylhexyl)phthalate	UG/KG	990	19%	50000	0	34	178	1900 U	1900 U	780 U	1900 U	1900 U
Butylbenzylphthalate	UG/KG	0	0%	50000	0	0	178	1900 UJ	1900 UJ	780 UJ	1900 UJ	1900 UJ
Caprolactam	UG/KG	0	0%		0	0	99					
Carbazole	UG/KG	755	19%		0	20	108					
Chrysene	UG/KG	8900	51%	400	62	91	178	7500	2900	1300	1800 J	2300
Di-n-butylphthalate	UG/KG	965	2%	8100	0	4	178	1900 U	1900 U	780 U	1900 U	1900 U
Di-n-octylphthalate	UG/KG	0	0%	50000	0	0	178	1900 U	1900 U	780 U	1900 U	1900 U
Dibenz(a,h)anthracene	UG/KG	1665	38%	14	67	68	178	1400 J	620 J	310 J	460 J	650 J
Dibenzofuran	UG/KG	2350	16%	6200	0	28	178	550 J	250 J	780 U	1900 U	1900 U
Diethyl phthalate	UG/KG	10	1%	7100	0	1	178	1900 U	1900 U	780 U	1900 U	1900 U
Dimethylphthalate	UG/KG	0	0%	2000	0	0	178	1900 U	1900 U	780 U	1900 U	1900 U
Fluoranthene	UG/KG	23500	54%	50000	0	97	178	16000	5200	1800	2900	4100
Fluorene	UG/KG	2640	28%	50000	0	49	178	1600 J	560 J	130 J	1900 U	200 J
Hexachlorobenzene	UG/KG	0	0%	410	0	0	178	1900 U	1900 U	780 U	1900 U	1900 U
Hexachlorobutadiene	UG/KG	0	0%		0	0	178	1900 U	1900 U	780 U	1900 U	1900 U
Hexachlorocyclopentadiene	UG/KG	0	0%		0	0	108					
Hexachloroethane	UG/KG	0	0%		0	0	178	1900 U	1900 U	780 U	1900 U	1900 U
Indeno(1,2,3-cd)pyrene	UG/KG	4950	47%	3200	2	84	178	3700 J	1700 J	920 J	1300 J	1900 J
Isophorone	UG/KG	0	0%	4400	0	0	178	1900 U	1900 U	780 U	1900 U	1900 U
N-Nitrosodiphenylamine	UG/KG	100	1%		0	1	108					
N-Nitrosodipropylamine	UG/KG	0	0%		0	0	108					
Naphthalene	UG/KG	1800	19%	13000	0	34	178	380 J	340 J	100 J	1900 U	1900 U
Nitrobenzene	UG/KG	0	0%	200	0	0	178	1900 U	1900 U	780 U	1900 U	1900 U
Pentachlorophenol	UG/KG	0	0%	1000	0	0	178	9900 U	9900 U	4000 U	9900 U	9800 U
Phenanthrene	UG/KG	21300	51%	50000	0	90	178	11000	3400	1000	1300 J	1800 J
Phenol	UG/KG	0	0%	30	0	0	178	1900 U	1900 U	780 U	1900 U	1900 U
Pyrene	UG/KG	19200	55%	50000	0	98	178	15000	5100	1700 J	2600	3500
Pyridine	UG/KG	0	0%		0	0	100	9900 U	9900 U	4000 U	9900 U	9800 U
Total Unknown PAHs as SV	MG/KG	25	100%		0	3	3					
Pesticides/PCBs												
4,4'-DDD	UG/KG	740	28%	2900	0	49	178	22 J	30	20 U	19 U	19 U
4,4'-DDE	UG/KG	2600	37%	2100	1	65	178	56	59	20 U	23	19 U
4,4'-DDT	UG/KG	3700	33%	2100	1	59	178	32	19 U	20 U	26	39
Aldrin	UG/KG	1.2	1%	41	0	1	178	10 U	9.9 U	10 U	10 U	9.8 U

**Table A-2A
SURFACE SOIL SAMPLE RESULTS (0-2 ft.)
SEAD-59
SEAD-59 and SEAD-71 Phase II RI Report
Seneca Army Depot Activity**

Facility	SEAD-59	SEAD-59	SEAD-59	SEAD-59	SEAD-59
Location ID	WS-59-01-013-1	WS-59-01-013-3	WS-59-01-013-4	WS-59-01-013-5	WS-59-01-013-6
Matrix	SOIL	SOIL	SOIL	SOIL	SOIL
Sample ID	WS-59-01-013-1	WS-59-01-013-3	WS-59-01-013-4	WS-59-01-013-5	WS-59-01-013-6
Sample Depth to Top of Sample ⁽¹⁾	0	0	0	0	0
Sample Depth to Bottom of Sample ⁽¹⁾	0	0	0	0	0
Sample Date	5/6/2004	5/6/2004	5/6/2004	5/6/2004	5/6/2004
QC Code	SA	SA	SA	SA	SA
Study ID	ENSR IRM	ENSR IRM	ENSR IRM	ENSR IRM	ENSR IRM
Sample Round	1	1	1	1	1

Parameter	Units	Maximum Value	Frequency of Detection	NYSDEC TAGM 4046 ⁽²⁾	Number of Exceedances	Number of Detects	Number of Analyses ⁽³⁾	Value (Q)	Value (Q)	Value (Q)	Value (Q)	Value (Q)
Alpha-BHC	UG/KG	0	0%	110	0	0	178	10 U	9.9 U	10 U	10 U	9.8 U
Alpha-Chlordane	UG/KG	34	4%		0	7	178	10 U	9.9 U	10 U	10 U	9.8 U
Beta-BHC	UG/KG	2.4	1%	200	0	1	178	10 U	9.9 U	10 U	10 U	9.8 U
Delta-BHC	UG/KG	0	0%	300	0	0	178	10 U	9.9 U	10 U	10 U	9.8 U
Dieldrin	UG/KG	0	0%	44	0	0	178	19 U	19 U	20 U	19 U	19 U
Endosulfan I	UG/KG	16	1%	900	0	1	178	10 U	9.9 U	10 U	10 U	9.8 U
Endosulfan II	UG/KG	0	0%	900	0	0	178	19 U	19 U	20 U	19 U	19 U
Endosulfan sulfate	UG/KG	6.2	1%	1000	0	1	178	19 U	19 U	20 U	19 U	19 U
Endrin	UG/KG	16	2%	100	0	3	178	19 U	19 U	20 U	19 U	19 U
Endrin aldehyde	UG/KG	4.9	1%		0	2	178	19 U	19 U	20 U	19 U	19 U
Endrin ketone	UG/KG	38	2%		0	4	178	19 U	19 U	20 U	19 U	19 U
Gamma-BHC/Lindane	UG/KG	0	0%	60	0	0	178	10 U	9.9 U	10 U	10 U	9.8 U
Gamma-Chlordane	UG/KG	24	8%	540	0	14	178	10 U	9.9 U	10 U	10 U	9.8 U
Heptachlor	UG/KG	0	0%	100	0	0	178	10 U	9.9 U	10 U	10 U	9.8 U
Heptachlor epoxide	UG/KG	3	1%	20	0	2	178	10 U	9.9 U	10 U	10 U	9.8 U
Methoxychlor	UG/KG	0	0%		0	0	178	99 U	99 U	100 U	99 U	98 U
Toxaphene	UG/KG	0	0%		0	0	178	190 U	190 U	200 U	190 U	190 U
Aroclor-1016	UG/KG	0	0%		0	0	178	39 U	38 U	39 U	38 U	38 U
Aroclor-1221	UG/KG	0	0%		0	0	178	39 U	38 U	39 U	38 U	38 U
Aroclor-1232	UG/KG	0	0%		0	0	178	39 U	38 U	39 U	38 U	38 U
Aroclor-1242	UG/KG	0	0%		0	0	178	39 U	38 U	39 U	38 U	38 U
Aroclor-1248	UG/KG	0	0%		0	0	178	39 U	38 U	39 U	38 U	38 U
Aroclor-1254	UG/KG	0	0%	10000	0	0	178	39 U	38 U	39 U	38 U	38 U
Aroclor-1260	UG/KG	79	1%	10000	0	2	178	39 U	38 U	39 U	77	38 U
Metals												
Aluminum	MG/KG	18300	100%	19300	0	178	178	11600	11900	12100	11700	11300
Antimony	MG/KG	424	58%	5.9	5	104	178	3.3 U	3.4 U	3.3 U	3.4 U	3.3 U
Arsenic	MG/KG	32.2	100%	8.2	7	178	178	4.7	5.1	4.6	6	4.6
Barium	MG/KG	304	100%	300	1	178	178	102	108	89.9	105	94.6
Beryllium	MG/KG	2.6	99%	1.1	2	176	178	0.34	0.36	0.4	0.4	0.34
Cadmium	MG/KG	3.2	86%	2.3	2	153	178	0.4 J	0.4 J	0.33 J	0.58	0.39 J
Calcium	MG/KG	214000	100%	121000	1	178	178	57400	31600	46400	38600	34300
Chromium	MG/KG	39.3	100%	29.6	2	178	178	18.9	19.2	19.9	23.4	19.3
Cobalt	MG/KG	47.8	100%	30	2	178	178	10.6	11.4	10.3	11.7	10.4
Copper	MG/KG	305	100%	33	19	178	178	26.1	26.1	24.8	30.5	40.6
Cyanide	MG/KG	0	0%	0.35	0	0	9					
Iron	MG/KG	64000	100%	36500	1	178	178	20100	22300	23400	25400	21000
Lead	MG/KG	164	100%	24.8	75	178	178	34.4 J	36.3 J	29.4 J	84.6 J	42 J
Magnesium	MG/KG	30200	100%	21500	3	178	178	7180	6700	8210	8040	8630
Manganese	MG/KG	1290	100%	1060	3	178	178	570	628	588	655	588
Mercury	MG/KG	0.95	95%	0.1	37	169	178	0.1	0.06	0.05	0.07	0.06
Nickel	MG/KG	88.3	100%	49	3	178	178	29.6	29.6	29.7	33	29.4
Potassium	MG/KG	2290	100%	2380	0	178	178	1200	1300	1280	1320	1230
Selenium	MG/KG	1.5	9%	2	0	16	178	0.6 J	0.56 U	0.55 U	0.78 J	0.55 U
Silver	MG/KG	2.9	49%	0.75	62	87	178	0.55 U	0.56 U	0.55 U	0.57 U	0.55 U

**Table A-2A
SURFACE SOIL SAMPLE RESULTS (0-2 ft.)
SEAD-59
SEAD-59 and SEAD-71 Phase II RI Report
Seneca Army Depot Activity**

Facility	SEAD-59	SEAD-59	SEAD-59	SEAD-59	SEAD-59
Location ID	WS-59-01-013-1	WS-59-01-013-3	WS-59-01-013-4	WS-59-01-013-5	WS-59-01-013-6
Maxtrix	SOIL	SOIL	SOIL	SOIL	SOIL
Sample ID	WS-59-01-013-1	WS-59-01-013-3	WS-59-01-013-4	WS-59-01-013-5	WS-59-01-013-6
Sample Depth to Top of Sample ⁽¹⁾	0	0	0	0	0
Sample Depth to Bottom of Sample ⁽¹⁾	0	0	0	0	0
Sample Date	5/6/2004	5/6/2004	5/6/2004	5/6/2004	5/6/2004
QC Code	SA	SA	SA	SA	SA
Study ID	ENSR IRM	ENSR IRM	ENSR IRM	ENSR IRM	ENSR IRM
Sample Round	1	1	1	1	1

Parameter	Units	Maximum Value	Frequency of Detection	NYSDEC TAGM 4046 ⁽²⁾	Number of Exceedances	Number of Detects	Number of Analyses ⁽³⁾	Value (Q)	Value (Q)	Value (Q)	Value (Q)	Value (Q)
Sodium	MG/KG	4060	99%	172	86	177	178	141	186	169	182	203
Thallium	MG/KG	1.8	29%	0.7	24	51	178	0.99 J	0.92 J	0.88 J	0.96 J	0.87 J
Vanadium	MG/KG	28.5	100%	150	0	178	178	21.1	22.5	20	21.2	21
Zinc	MG/KG	341	100%	110	19	178	178	88.4 J	85.2 J	84.5 J	120 J	91.1 J

Note(s):

- (1) - Historical sample depths are presented (I.e. prior to 2002 TCRA)
- (2) - NYSDEC Technical and Administrative Guidance Memorandum (TAGM) HWR-94-4046, Revised January 24, 1994
- (3) - Sample/Duplicate pair are presented as individual samples in this table. Statistical information used Sample Duplicate pairs as a single entity and averaged result values were used in risk assessment analysis.

U = compound was not detected
 J = the reported value is an estimated concentration
 UJ = the compound was not detected; the associated reporting limit is approximate
 R = the data was rejected in the data validating process
 NJ = compound was "tentatively identified" and the associated numerical value is approximate

Table A-2A
SURFACE SOIL SAMPLE RESULTS (0-2 ft.)
SEAD-59
SEAD-59 and SEAD-71 Phase II RI Report
Seneca Army Depot Activity

Facility	SEAD-59	SEAD-59	SEAD-59	SEAD-59	SEAD-59
Location ID	WS-59-01-013-7	WS-59-01-014-1	WS-59-01-014-2	WS-59-01-014-3	WS-59-01-014-4
Matrix	SOIL	SOIL	SOIL	SOIL	SOIL
Sample ID	WS-59-01-013-7	WS-59-01-014-1	WS-59-01-014-2	WS-59-01-014-3	WS-59-01-014-4
Sample Depth to Top of Sample ⁽¹⁾	0	0	0	0	0
Sample Depth to Bottom of Sample ⁽¹⁾	0	0	0	0	0
Sample Date	5/6/2004	5/6/2004	5/6/2004	5/6/2004	5/6/2004
QC Code	SA	SA	SA	SA	SA
Study ID	ENSR IRM	ENSR IRM	ENSR IRM	ENSR IRM	ENSR IRM
Sample Round	1	1	1	1	1

Parameter	Units	Maximum Value	Frequency of Detection	NYSDEC TAGM 4046 ⁽²⁾	Number of Exceedances	Number of Detects	Number of Analyses ⁽³⁾	Value (Q)	Value (Q)	Value (Q)	Value (Q)	Value (Q)
Volatile Organics												
1,1,1-Trichloroethane	UG/KG	0	0%	800	0	0	177	6.1 U	6 U	6 U	6 U	6 U
1,1,2,2-Tetrachloroethane	UG/KG	0	0%	600	0	0	169	6.1 U	6 UJ	6 UJ	6 U	6 UJ
1,1,2-Trichloro-1,2,2-Trifluoroethane	UG/KG	0	0%		0	0	168	6.1 U	6 U	6 U	6 U	6 U
1,1,2-Trichloroethane	UG/KG	0	0%		0	0	107		6 U	6 U	6 U	6 U
1,1-Dichloroethane	UG/KG	0	0%	200	0	0	177	6.1 U	6 U	6 U	6 U	6 U
1,1-Dichloroethene	UG/KG	8	2%	400	0	3	177	6.1 U	6 U	6 U	6 U	6 U
1,2,3-Trichloropropane	UG/KG	0	0%		0	0	70	6.1 U				
1,2,4-Trichlorobenzene	UG/KG	0	0%	3400	0	0	161	6.1 U	6 UJ	6 UJ	6 U	6 UJ
1,2-Dibromo-3-chloropropane	UG/KG	0	0%		0	0	91		6 UJ	6 UJ	6 U	6 UJ
1,2-Dibromoethane	UG/KG	0	0%		0	0	98		6 U	6 U	6 U	6 U
1,2-Dichlorobenzene	UG/KG	0	0%	7900	0	0	161	6.1 U	6 UJ	6 UJ	6 U	6 UJ
1,2-Dichloroethane	UG/KG	0	0%	100	0	0	177	6.1 U	6 U	6 U	6 U	6 U
1,2-Dichloroethene (total)	UG/KG	0	0%		0	0	9					
1,2-Dichloropropane	UG/KG	0	0%		0	0	107		6 U	6 U	6 U	6 U
1,3-Dichlorobenzene	UG/KG	0	0%	1600	0	0	161	6.1 U	6 UJ	6 UJ	6 U	6 UJ
1,3-Dichloropropane	UG/KG	0	0%		0	0	70	6.1 U				
1,4-Dichlorobenzene	UG/KG	0	0%	8500	0	0	161	6.1 U	6 UJ	6 UJ	6 U	6 UJ
Acetone	UG/KG	550	27%	200	2	47	177	25 U	6 U	15 NJ	110 NJ	6 U
Benzene	UG/KG	3	4%	60	0	7	177	6.1 U	6 U	6 U	6 U	6 U
Bromodichloromethane	UG/KG	0	0%		0	0	107		6 U	6 U	6 U	6 U
Bromoform	UG/KG	0	0%		0	0	107		6 U	6 U	6 U	6 U
Carbon disulfide	UG/KG	4	3%	2700	0	6	177	6.1 U	6 U	6 U	6 U	6 U
Carbon tetrachloride	UG/KG	0	0%	600	0	0	177	6.1 U	6 U	6 U	6 U	6 U
Chlorobenzene	UG/KG	0	0%	1700	0	0	177	6.1 U	6 U	6 U	6 U	6 U
Chlorodibromomethane	UG/KG	0	0%		0	0	177	6.1 U	6 U	6 U	6 U	6 U
Chloroethane	UG/KG	0	0%	1900	0	0	177	12 U	6 U	6 U	6 U	6 U
Chloroform	UG/KG	0	0%	300	0	0	177	6.1 U	6 U	6 U	6 U	6 U
Cis-1,2-Dichloroethene	UG/KG	0	0%		0	0	98		6 U	6 U	6 U	6 U
Cis-1,3-Dichloropropene	UG/KG	0	0%		0	0	107		6 U	6 U	6 U	6 U
Cyclohexane	UG/KG	3	8%		0	8	98		6 U	6 U	6 U	6 U
Dichlorodifluoromethane	UG/KG	0	0%		0	0	98		6 U	6 U	6 U	6 U
Ethyl benzene	UG/KG	4.6	1%	5500	0	2	177	6.1 U	6 U	6 U	6 U	6 U
Isopropylbenzene	UG/KG	0	0%		0	0	98		6 U	6 U	6 U	6 U
Meta/Para Xylene	UG/KG	9.4	4%		0	3	70	6.1 U				
Methyl Acetate	UG/KG	2	3%		0	3	98		6 U	6 U	6 U	6 U
Methyl Tertbutyl Ether	UG/KG	0	0%		0	0	98		6 U	6 U	6 U	6 U
Methyl bromide	UG/KG	0	0%		0	0	107		6 U	6 U	6 U	6 U
Methyl butyl ketone	UG/KG	0	0%		0	0	107		6 U	6 U	6 U	6 U
Methyl chloride	UG/KG	0	0%		0	0	107		6 U	6 U	6 U	6 U
Methyl cyclohexane	UG/KG	5	10%		0	10	98		6 U	6 U	6 U	6 U
Methyl ethyl ketone	UG/KG	190	12%	300	0	22	177	12 U	6 U	6 U	8 J	6 U
Methyl isobutyl ketone	UG/KG	1.9	1%	1000	0	1	177	12 U	6 U	6 U	6 U	6 U
Methylene chloride	UG/KG	4.9	20%	100	0	36	178	6.1 U	6 U	6 U	6 U	6 U
Ortho Xylene	UG/KG	5.05	4%		0	3	70	6.1 U				

**Table A-2A
SURFACE SOIL SAMPLE RESULTS (0-2 ft.)
SEAD-59
SEAD-59 and SEAD-71 Phase II RI Report
Seneca Army Depot Activity**

Facility	SEAD-59	SEAD-59	SEAD-59	SEAD-59	SEAD-59
Location ID	WS-59-01-013-7	WS-59-01-014-1	WS-59-01-014-2	WS-59-01-014-3	WS-59-01-014-4
Matrix	SOIL	SOIL	SOIL	SOIL	SOIL
Sample ID	WS-59-01-013-7	WS-59-01-014-1	WS-59-01-014-2	WS-59-01-014-3	WS-59-01-014-4
Sample Depth to Top of Sample ⁽¹⁾	0	0	0	0	0
Sample Depth to Bottom of Sample ⁽¹⁾	0	0	0	0	0
Sample Date	5/6/2004	5/6/2004	5/6/2004	5/6/2004	5/6/2004
QC Code	SA	SA	SA	SA	SA
Study ID	ENSR IRM	ENSR IRM	ENSR IRM	ENSR IRM	ENSR IRM
Sample Round	1	1	1	1	1

Parameter	Units	Maximum Value	Frequency of Detection	NYSDEC TAGM 4046 ⁽²⁾	Number of Exceedances	Number of Detects	Number of Analyses ⁽³⁾	Value (Q)	Value (Q)	Value (Q)	Value (Q)	Value (Q)
Styrene	UG/KG	0	0%		0	0	107		6 U	6 U	6 U	6 U
Tetrachloroethene	UG/KG	6.4	3%	1400	0	5	177	6.1 U	6 U	6 U	6 U	6 U
Toluene	UG/KG	8	8%	1500	0	14	177	6.1 U	6 U	6 U	6 U	6 U
Total BTEX	MG/KG	3.25	67%		0	2	3					
Total Xylenes	UG/KG	3	7%	1200	0	7	102		6 UJ	6 UJ	6 U	6 UJ
Trans-1,2-Dichloroethene	UG/KG	0	0%	300	0	0	168	6.1 U	6 U	6 U	6 U	6 U
Trans-1,3-Dichloropropene	UG/KG	0	0%		0	0	107		6 U	6 U	6 U	6 U
Trichloroethene	UG/KG	4.5	5%	700	0	8	177	6.1 U	6 U	6 U	6 U	6 U
Trichlorofluoromethane	UG/KG	6	1%		0	1	98		6 U	6 U	6 U	6 U
Vinyl chloride	UG/KG	0	0%	200	0	0	177	12 U	6 U	6 U	6 U	6 U
Semivolatile Organics												
1,1'-Biphenyl	UG/KG	254.5	2%		0	2	99		400 U	400 U	410 U	410 U
1,2,4-Trichlorobenzene	UG/KG	0	0%	3400	0	0	9					
1,2-Dichlorobenzene	UG/KG	0	0%	7900	0	0	9					
1,3-Dichlorobenzene	UG/KG	0	0%	1600	0	0	9					
1,4-Dichlorobenzene	UG/KG	0	0%	8500	0	0	9					
2,2'-oxybis(1-Chloropropane)	UG/KG	0	0%		0	0	105		400 U	400 U	410 U	410 U
2,4,5-Trichlorophenol	UG/KG	0	0%	100	0	0	178	810 U	1000 U	1000 U	1000 U	1000 U
2,4,6-Trichlorophenol	UG/KG	0	0%		0	0	178	810 U	400 U	400 U	410 U	410 U
2,4-Dichlorophenol	UG/KG	0	0%	400	0	0	178	810 U	400 U	400 U	410 U	410 U
2,4-Dimethylphenol	UG/KG	0	0%		0	0	108		400 U	400 U	410 U	410 U
2,4-Dinitrophenol	UG/KG	0	0%	200	0	0	178	4200 U	1000 UJ	1000 UJ	1000 UJ	1000 U
2,4-Dinitrotoluene	UG/KG	0	0%		0	0	178	810 U	400 U	400 U	410 U	410 U
2,6-Dinitrotoluene	UG/KG	0	0%	1000	0	0	178	810 U	400 U	400 U	410 U	410 U
2-Chloronaphthalene	UG/KG	0	0%		0	0	108		400 U	400 U	410 U	410 U
2-Chlorophenol	UG/KG	0	0%	800	0	0	178	810 U	400 U	400 U	410 U	410 U
2-Methylnaphthalene	UG/KG	1295	19%	36400	0	34	178	810 U	400 U	53 J	410 U	410 U
2-Methylphenol	UG/KG	0	0%	100	0	0	178	810 U	400 U	400 U	410 U	410 U
2-Nitroaniline	UG/KG	0	0%	430	0	0	178	4200 U	1000 U	1000 U	1000 U	1000 U
2-Nitrophenol	UG/KG	0	0%	330	0	0	178	810 U	400 U	400 U	410 U	410 U
3,3'-Dichlorobenzidine	UG/KG	0	0%		0	0	178	810 U	400 UJ	400 UJ	410 UJ	410 U
3-Nitroaniline	UG/KG	0	0%	500	0	0	178	4200 U	1000 U	1000 U	1000 U	1000 U
4,6-Dinitro-2-methylphenol	UG/KG	0	0%		0	0	108		1000 U	1000 U	1000 U	1000 U
4-Bromophenyl phenyl ether	UG/KG	0	0%		0	0	108		400 U	400 U	410 U	410 U
4-Chloro-3-methylphenol	UG/KG	0	0%	240	0	0	178	810 U	400 U	400 U	410 U	410 U
4-Chloroaniline	UG/KG	1200	1%	220	1	2	178	810 U	400 UJ	400 UJ	410 UJ	410 U
4-Chlorophenyl phenyl ether	UG/KG	0	0%		0	0	108		400 U	400 U	410 U	410 U
4-Methylphenol	UG/KG	150	3%	900	0	5	178	810 U	54 J	400 U	410 U	410 U
4-Nitroaniline	UG/KG	0	0%		0	0	108		1000 U	1000 U	1000 U	1000 U
4-Nitrophenol	UG/KG	0	0%	100	0	0	178	4200 U	1000 U	1000 U	1000 U	1000 U
Acenaphthene	UG/KG	2680	24%	50000	0	42	178	810 U	400 U	110 J	410 U	73 J
Acenaphthylene	UG/KG	1700	37%	41000	0	66	178	280 J	170 J	330 J	120 J	180 J
Acetophenone	UG/KG	0	0%		0	0	99		400 U	400 U	410 U	410 U
Aniline	UG/KG	0	0%		0	0	70	810 U				
Anthracene	UG/KG	4395	43%	50000	0	77	178	290 J	77 J	320 J	75 J	360 J

Table A-2A
SURFACE SOIL SAMPLE RESULTS (0-2 ft.)
SEAD-59
SEAD-59 and SEAD-71 Phase II RI Report
Seneca Army Depot Activity

Facility	SEAD-59	SEAD-59	SEAD-59	SEAD-59	SEAD-59
Location ID	WS-59-01-013-7	WS-59-01-014-1	WS-59-01-014-2	WS-59-01-014-3	WS-59-01-014-4
Matrix	SOIL	SOIL	SOIL	SOIL	SOIL
Sample ID	WS-59-01-013-7	WS-59-01-014-1	WS-59-01-014-2	WS-59-01-014-3	WS-59-01-014-4
Sample Depth to Top of Sample ⁽¹⁾	0	0	0	0	0
Sample Depth to Bottom of Sample ⁽¹⁾	0	0	0	0	0
Sample Date	5/6/2004	5/6/2004	5/6/2004	5/6/2004	5/6/2004
QC Code	SA	SA	SA	SA	SA
Study ID	ENSR IRM	ENSR IRM	ENSR IRM	ENSR IRM	ENSR IRM
Sample Round	1	1	1	1	1

Parameter	Units	Maximum Value	Frequency of Detection	NYSDEC TAGM 4046 ⁽²⁾	Number of Exceedances	Number of Detects	Number of Analyses ⁽³⁾	Value (Q)	Value (Q)	Value (Q)	Value (Q)	Value (Q)
Atrazine	UG/KG	120	1%		0	1	99		400 U	400 U	410 U	410 U
Benzaldehyde	UG/KG	50	1%		0	1	99		400 U	400 U	410 U	410 U
Benzo(a)anthracene	UG/KG	8900	51%	224	72	90	178	1300	490 NJ	1400 NJ	270 J	1000 NJ
Benzo(a)pyrene	UG/KG	8050	51%	611	84	91	178	1400	650 J	2100 J	360 J	890
Benzo(b)fluoranthene	UG/KG	6800	52%	1100	40	92	178	1200	830 J	2700 J	450 J	1100
Benzo(ghi)perylene	UG/KG	5200	46%	50000	0	82	178	940	430 J	1100 J	220 J	380 J
Benzo(k)fluoranthene	UG/KG	7350	49%	1100	35	88	178	1200	440 J	990 J	280 NJ	440
Benzoic Acid	UG/KG	0	0%	2700	0	0	70	4200 U				
Bis(2-Chloroethoxy)methane	UG/KG	0	0%		0	0	108		400 U	400 U	410 U	410 U
Bis(2-Chloroethyl)ether	UG/KG	0	0%		0	0	108		400 U	400 U	410 U	410 U
Bis(2-Chloroisopropyl)ether	UG/KG	0	0%		0	0	3					
Bis(2-Ethylhexyl)phthalate	UG/KG	990	19%	50000	0	34	178	810 U	110 NJ	84 NJ	150 J	49 J
Butylbenzylphthalate	UG/KG	0	0%	50000	0	0	178	810 UJ	400 UJ	400 UJ	410 UJ	410 U
Caprolactam	UG/KG	0	0%		0	0	99		400 U	400 U	410 U	410 U
Carbazole	UG/KG	755	19%		0	20	108		400 U	78 J	46 J	55 J
Chrysene	UG/KG	8900	51%	400	62	91	178	1300	550 J	1600 J	330 J	970
Di-n-butylphthalate	UG/KG	965	2%	8100	0	4	178	810 U	400 U	400 U	410 U	410 U
Di-n-octylphthalate	UG/KG	0	0%	50000	0	0	178	810 U	400 UJ	400 UJ	410 UJ	410 U
Dibenz(a,h)anthracene	UG/KG	1665	38%	14	67	68	178	320 J	100 J	320 J	66 J	120 J
Dibenzofuran	UG/KG	2350	16%	6200	0	28	178	810 U	400 U	53 J	410 U	410 U
Diethyl phthalate	UG/KG	10	1%	7100	0	1	178	810 U	400 U	400 U	410 U	410 U
Dimethylphthalate	UG/KG	0	0%	2000	0	0	178	810 U	400 U	400 U	410 U	410 U
Fluoranthene	UG/KG	23500	54%	50000	0	97	178	2900	590	1700	430	2300
Fluorene	UG/KG	2640	28%	50000	0	49	178	110 J	44 J	140 J	47 J	100 J
Hexachlorobenzene	UG/KG	0	0%	410	0	0	178	810 U	400 U	400 U	410 U	410 U
Hexachlorobutadiene	UG/KG	0	0%		0	0	178	810 U	400 U	400 U	410 U	410 U
Hexachlorocyclopentadiene	UG/KG	0	0%		0	0	108		400 U	400 U	410 U	410 U
Hexachloroethane	UG/KG	0	0%		0	0	178	810 U	400 U	400 U	410 U	410 U
Indeno(1,2,3-cd)pyrene	UG/KG	4950	47%	3200	2	84	178	880 J	380 J	1100 J	200 J	450
Isophorone	UG/KG	0	0%	4400	0	0	178	810 U	400 U	400 U	410 U	410 U
N-Nitrosodiphenylamine	UG/KG	100	1%		0	1	108		400 U	400 U	410 U	410 U
N-Nitrosodipropylamine	UG/KG	0	0%		0	0	108		400 U	400 U	410 U	410 U
Naphthalene	UG/KG	1800	19%	13000	0	34	178	810 U	49 J	63 J	55 J	410 U
Nitrobenzene	UG/KG	0	0%	200	0	0	178	810 U	400 U	400 U	410 U	410 U
Pentachlorophenol	UG/KG	0	0%	1000	0	0	178	4200 U	1000 U	1000 U	1000 U	1000 U
Phenanthrene	UG/KG	21300	51%	50000	0	90	178	1500	240 J	780	270 J	900
Phenol	UG/KG	0	0%	30	0	0	178	810 U	400 U	400 U	410 U	410 U
Pyrene	UG/KG	19200	55%	50000	0	98	178	2300 J	1100 J	2300	780 J	2100
Pyridine	UG/KG	0	0%		0	0	100	4200 U				
Total Unknown PAHs as SV	MG/KG	25	100%		0	3	3					
Pesticides/PCBs												
4,4'-DDD	UG/KG	740	28%	2900	0	49	178	20 U	11 J	10 NJ	12	16 J
4,4'-DDE	UG/KG	2600	37%	2100	1	65	178	20 U	56 J	18 NJ	38 J	19
4,4'-DDT	UG/KG	3700	33%	2100	1	59	178	20 U	8.6	4 U	8	34
Aldrin	UG/KG	1.2	1%	41	0	1	178	10 U	2 U	2.1 U	2.1 U	2.1 U

Table A-2A
SURFACE SOIL SAMPLE RESULTS (0-2 ft.)
SEAD-59
SEAD-59 and SEAD-71 Phase II RI Report
Seneca Army Depot Activity

Facility	SEAD-59	SEAD-59	SEAD-59	SEAD-59	SEAD-59							
Location ID	WS-59-01-013-7	WS-59-01-014-1	WS-59-01-014-2	WS-59-01-014-3	WS-59-01-014-4							
Matrix	SOIL	SOIL	SOIL	SOIL	SOIL							
Sample ID	WS-59-01-013-7	WS-59-01-014-1	WS-59-01-014-2	WS-59-01-014-3	WS-59-01-014-4							
Sample Depth to Top of Sample ⁽¹⁾	0	0	0	0	0							
Sample Depth to Bottom of Sample ⁽¹⁾	0	0	0	0	0							
Sample Date	5/6/2004	5/6/2004	5/6/2004	5/6/2004	5/6/2004							
QC Code	SA	SA	SA	SA	SA							
Study ID	ENSR IRM	ENSR IRM	ENSR IRM	ENSR IRM	ENSR IRM							
Sample Round	1	1	1	1	1							
Parameter	Units	Maximum Value	Frequency of Detection	NYSDEC TAGM 4046 ⁽²⁾	Number of Exceedances	Number of Detects	Number of Analyses ⁽³⁾	Value (Q)	Value (Q)	Value (Q)	Value (Q)	Value (Q)
Alpha-BHC	UG/KG	0	0%	110	0	0	178	10 U	2 U	2.1 U	2.1 U	2.1 U
Alpha-Chlordane	UG/KG	34	4%		0	7	178	10 U	2 U	2.1 U	2.1 U	2.1 U
Beta-BHC	UG/KG	2.4	1%	200	0	1	178	10 U	2 U	2.1 U	2.1 U	2.1 U
Delta-BHC	UG/KG	0	0%	300	0	0	178	10 U	2 U	2.1 U	2.1 U	2.1 U
Dieldrin	UG/KG	0	0%	44	0	0	178	20 U	4 U	4 U	4.1 U	4.1 U
Endosulfan I	UG/KG	16	1%	900	0	1	178	10 U	2 U	2.1 U	2.1 U	2.1 U
Endosulfan II	UG/KG	0	0%	900	0	0	178	20 U	4 U	4 U	4.1 U	4.1 U
Endosulfan sulfate	UG/KG	6.2	1%	1000	0	1	178	20 U	4 U	4 U	4.1 U	4.1 U
Endrin	UG/KG	16	2%	100	0	3	178	20 U	4 U	4 U	4.1 U	4.1 U
Endrin aldehyde	UG/KG	4.9	1%		0	2	178	20 U	4 U	4 U	4.1 U	4.1 U
Endrin ketone	UG/KG	38	2%		0	4	178	20 U	4 U	4 U	4.1 U	4.1 U
Gamma-BHC/Lindane	UG/KG	0	0%	60	0	0	178	10 U	2 U	2.1 U	2.1 U	2.1 U
Gamma-Chlordane	UG/KG	24	8%	540	0	14	178	10 U	2 U	2.1 U	2.1 U	2.1 U
Heptachlor	UG/KG	0	0%	100	0	0	178	10 U	2 U	2.1 U	2.1 U	2.1 U
Heptachlor epoxide	UG/KG	3	1%	20	0	2	178	10 U	2 U	2.1 U	2.1 U	2.1 U
Methoxychlor	UG/KG	0	0%		0	0	178	100 U	20 U	21 U	21 U	21 U
Toxaphene	UG/KG	0	0%		0	0	178	200 U	200 U	210 U	210 U	210 U
Aroclor-1016	UG/KG	0	0%		0	0	178	40 U	40 U	41 U	42 U	41 U
Aroclor-1221	UG/KG	0	0%		0	0	178	40 U	40 U	41 U	42 U	41 U
Aroclor-1232	UG/KG	0	0%		0	0	178	40 U	40 U	41 U	42 U	41 U
Aroclor-1242	UG/KG	0	0%		0	0	178	40 U	40 U	41 U	42 U	41 U
Aroclor-1248	UG/KG	0	0%		0	0	178	40 U	40 U	41 U	42 U	41 U
Aroclor-1254	UG/KG	0	0%	10000	0	0	178	40 U	40 U	41 U	42 U	41 U
Aroclor-1260	UG/KG	79	1%	10000	0	2	178	40 U	40 U	41 U	42 U	41 U
Metals												
Aluminum	MG/KG	18300	100%	19300	0	178	178	12200	12800 J	13000 J	14100 J	12300 J
Antimony	MG/KG	424	58%	5.9	5	104	178	3.6 U	1.9 J	1.6 J	1.8 J	1.7 J
Arsenic	MG/KG	32.2	100%	8.2	7	178	178	4.8	6.5 J	6.2 J	7.2 J	5.7 J
Barium	MG/KG	304	100%	300	1	178	178	131	109 J	106 J	153 J	139 J
Beryllium	MG/KG	2.6	99%	1.1	2	176	178	0.35	0.71	0.66	0.77	0.67
Cadmium	MG/KG	3.2	86%	2.3	2	153	178	0.42 J	0.6	0.53	0.63	0.52
Calcium	MG/KG	214000	100%	121000	1	178	178	15100	25700 J	35400 J	19700 J	16400 J
Chromium	MG/KG	39.3	100%	29.6	2	178	178	19.2	18.9 J	20 J	19.9 J	17.7 J
Cobalt	MG/KG	47.8	100%	30	2	178	178	11.1	10.1 J	11 J	10.9 J	9.6 J
Copper	MG/KG	305	100%	33	19	178	178	25	28.3 J	28.7 J	28 J	24.4 J
Cyanide	MG/KG	0	0%	0.35	0	0	9					
Iron	MG/KG	64000	100%	36500	1	178	178	20500	21800 J	21800 J	23700 J	20400 J
Lead	MG/KG	164	100%	24.8	75	178	178	32 J	29.5 J	34.5 J	27.8 J	27 J
Magnesium	MG/KG	30200	100%	21500	3	178	178	5780	7370 J	8410 J	5600 J	5510 J
Manganese	MG/KG	1290	100%	1060	3	178	178	679	797 J	528 J	828 J	703 J
Mercury	MG/KG	0.95	95%	0.1	37	169	178	0.09	0.07	0.05	0.07 J	0.09 J
Nickel	MG/KG	88.3	100%	49	3	178	178	31.9	28.9 J	32.8 J	31.8 J	26.3 J
Potassium	MG/KG	2290	100%	2380	0	178	178	1290	1400 J	1400 J	1470 J	1270 J
Selenium	MG/KG	1.5	9%	2	0	16	178	0.6 U	0.48 U	0.41 U	0.46 U	0.4 U
Silver	MG/KG	2.9	49%	0.75	62	87	178	0.6 U	0.96	0.7	1.1	0.96

**Table A-2A
SURFACE SOIL SAMPLE RESULTS (0-2 ft.)
SEAD-59
SEAD-59 and SEAD-71 Phase II RI Report
Seneca Army Depot Activity**

Facility	SEAD-59	SEAD-59	SEAD-59	SEAD-59	SEAD-59
Location ID	WS-59-01-013-7	WS-59-01-014-1	WS-59-01-014-2	WS-59-01-014-3	WS-59-01-014-4
Matrix	SOIL	SOIL	SOIL	SOIL	SOIL
Sample ID	WS-59-01-013-7	WS-59-01-014-1	WS-59-01-014-2	WS-59-01-014-3	WS-59-01-014-4
Sample Depth to Top of Sample ⁽¹⁾	0	0	0	0	0
Sample Depth to Bottom of Sample ⁽¹⁾	0	0	0	0	0
Sample Date	5/6/2004	5/6/2004	5/6/2004	5/6/2004	5/6/2004
QC Code	SA	SA	SA	SA	SA
Study ID	ENSR IRM	ENSR IRM	ENSR IRM	ENSR IRM	ENSR IRM
Sample Round	1	1	1	1	1

Parameter	Units	Maximum Value	Frequency of Detection	NYSDEC TAGM 4046 ⁽²⁾	Number of Exceedances	Number of Detects	Number of Analyses ⁽³⁾	Value (Q)	Value (Q)	Value (Q)	Value (Q)	Value (Q)
Sodium	MG/KG	4060	99%	172	86	177	178	249	244 J	245 J	281 J	341 J
Thallium	MG/KG	1.8	29%	0.7	24	51	178	0.93 J	0.24 U	0.2 U	0.23 U	0.2 U
Vanadium	MG/KG	28.5	100%	150	0	178	178	22.2	21.8 J	22.5 J	22.7 J	20 J
Zinc	MG/KG	341	100%	110	19	178	178	85.6 J	88.1 J	87.5 J	96.2 J	88.6 J

Note(s):

- (1) - Historical sample depths are presented (I.e. prior to 2002 TCRA)
- (2) - NYSDEC Technical and Administrative Guidance Memorandum (TAGM) HWR-94-4046, Revised January 24, 1994
- (3) - Sample/Duplicate pair are presented as individual samples in this table. Statistical information used Sample Duplicate pairs as a single entity and averaged result values were used in risk assessment analysis.

U = compound was not detected

J = the reported value is an estimated concentration

UJ = the compound was not detected; the associated reporting limit is approximate

R = the data was rejected in the data validating process

NJ = compound was "tentatively identified" and the associated numerical value is approximate

Table A-2A
SURFACE SOIL SAMPLE RESULTS (0-2 ft.)
SEAD-59
SEAD-59 and SEAD-71 Phase II RI Report
Seneca Army Depot Activity

Facility	SEAD-59	SEAD-59	SEAD-59	SEAD-59	SEAD-59
Location ID	WS-59-01-015-1	WS-59-01-015-10	WS-59-01-015-11	WS-59-01-015-18	WS-59-01-015-19
Matrix	SOIL	SOIL	SOIL	SOIL	SOIL
Sample ID	WS-59-01-015-1	WS-59-01-015-10	WS-59-01-015-11	WS-59-01-015-18	WS-59-01-015-19
Sample Depth to Top of Sample ⁽¹⁾	0	0	0	0	0
Sample Depth to Bottom of Sample ⁽¹⁾	0	0	0	0	0
Sample Date	5/6/2004	5/6/2004	5/6/2004	5/6/2004	5/6/2004
QC Code	SA	SA	SA	SA	SA
Study ID	ENSR IRM	ENSR IRM	ENSR IRM	ENSR IRM	ENSR IRM
Sample Round	1	1	1	1	1

Parameter	Units	Maximum Value	Frequency of Detection	NYSDEC TAGM 4046 ⁽²⁾	Number of Exceedances	Number of Detects	Number of Analyses ⁽³⁾	Value (Q)	Value (Q)	Value (Q)	Value (Q)	Value (Q)
Volatile Organics												
1,1,1-Trichloroethane	UG/KG	0	0%	800	0	0	177	6.2 U	6 U	6 U	5.9 U	5.8 U
1,1,2,2-Tetrachloroethane	UG/KG	0	0%	600	0	0	169	6.2 U	6 U	6 U	5.9 U	5.8 U
1,1,2-Trichloro-1,2,2-Trifluoroethane	UG/KG	0	0%		0	0	168	6.2 U	6 U	6 U	5.9 U	5.8 U
1,1,2-Trichloroethane	UG/KG	0	0%		0	0	107					
1,1-Dichloroethane	UG/KG	0	0%	200	0	0	177	6.2 U	6 U	6 U	5.9 U	5.8 U
1,1-Dichloroethene	UG/KG	8	2%	400	0	3	177	6.2 U	6 U	6 U	5.9 U	5.8 U
1,2,3-Trichloropropane	UG/KG	0	0%		0	0	70	6.2 U	6 U	6 U	5.9 U	5.8 U
1,2,4-Trichlorobenzene	UG/KG	0	0%	3400	0	0	161	6.2 U	6 U	6 U	5.9 U	5.8 U
1,2-Dibromo-3-chloropropane	UG/KG	0	0%		0	0	91					
1,2-Dibromoethane	UG/KG	0	0%		0	0	98					
1,2-Dichlorobenzene	UG/KG	0	0%	7900	0	0	161	6.2 U	6 U	6 U	5.9 U	5.8 U
1,2-Dichloroethane	UG/KG	0	0%	100	0	0	177	6.2 U	6 U	6 U	5.9 U	5.8 U
1,2-Dichloroethene (total)	UG/KG	0	0%		0	0	9					
1,2-Dichloropropane	UG/KG	0	0%		0	0	107					
1,3-Dichlorobenzene	UG/KG	0	0%	1600	0	0	161	6.2 U	6 U	6 U	5.9 U	5.8 U
1,3-Dichloropropane	UG/KG	0	0%		0	0	70	6.2 U	6 U	6 U	5.9 U	5.8 U
1,4-Dichlorobenzene	UG/KG	0	0%	8500	0	0	161	6.2 U	6 U	6 U	5.9 U	5.8 U
Acetone	UG/KG	550	27%	200	2	47	177	25 U	24 U	24 U	15 J	23 U
Benzene	UG/KG	3	4%	60	0	7	177	6.2 U	6 U	6 U	5.9 U	5.8 U
Bromodichloromethane	UG/KG	0	0%		0	0	107					
Bromoform	UG/KG	0	0%		0	0	107					
Carbon disulfide	UG/KG	4	3%	2700	0	6	177	6.2 U	6 U	6 U	5.9 U	5.8 U
Carbon tetrachloride	UG/KG	0	0%	600	0	0	177	6.2 U	6 U	6 U	5.9 U	5.8 U
Chlorobenzene	UG/KG	0	0%	1700	0	0	177	6.2 U	6 U	6 U	5.9 U	5.8 U
Chlorodibromomethane	UG/KG	0	0%		0	0	177	6.2 U	6 U	6 U	5.9 U	5.8 U
Chloroethane	UG/KG	0	0%	1900	0	0	177	12 U	12 U	12 U	12 U	12 U
Chloroform	UG/KG	0	0%	300	0	0	177	6.2 U	6 U	6 U	5.9 U	5.8 U
Cis-1,2-Dichloroethene	UG/KG	0	0%		0	0	98					
Cis-1,3-Dichloropropene	UG/KG	0	0%		0	0	107					
Cyclohexane	UG/KG	3	8%		0	8	98					
Dichlorodifluoromethane	UG/KG	0	0%		0	0	98					
Ethyl benzene	UG/KG	4.6	1%	5500	0	2	177	6.2 U	6 U	6 U	5.9 U	5.8 U
Isopropylbenzene	UG/KG	0	0%		0	0	98					
Meta/Para Xylene	UG/KG	9.4	4%		0	3	70	6.2 U	6 U	6 U	5.9 U	5.8 U
Methyl Acetate	UG/KG	2	3%		0	3	98					
Methyl Tertbutyl Ether	UG/KG	0	0%		0	0	98					
Methyl bromide	UG/KG	0	0%		0	0	107					
Methyl butyl ketone	UG/KG	0	0%		0	0	107					
Methyl chloride	UG/KG	0	0%		0	0	107					
Methyl cyclohexane	UG/KG	5	10%		0	10	98					
Methyl ethyl ketone	UG/KG	190	12%	300	0	22	177	12 U	12 U	12 U	12 U	12 U
Methyl isobutyl ketone	UG/KG	1.9	1%	1000	0	1	177	12 U	12 U	12 U	12 U	12 U
Methylene chloride	UG/KG	4.9	20%	100	0	36	178	6.2 U	6 U	6 U	5.9 U	5.8 U
Ortho Xylene	UG/KG	5.05	4%		0	3	70	6.2 U	6 U	6 U	5.9 U	5.8 U

Table A-2A
SURFACE SOIL SAMPLE RESULTS (0-2 ft.)
SEAD-59
SEAD-59 and SEAD-71 Phase II RI Report
Seneca Army Depot Activity

Facility	SEAD-59	SEAD-59	SEAD-59	SEAD-59	SEAD-59
Location ID	WS-59-01-015-1	WS-59-01-015-10	WS-59-01-015-11	WS-59-01-015-18	WS-59-01-015-19
Matrix	SOIL	SOIL	SOIL	SOIL	SOIL
Sample ID	WS-59-01-015-1	WS-59-01-015-10	WS-59-01-015-11	WS-59-01-015-18	WS-59-01-015-19
Sample Depth to Top of Sample ⁽¹⁾	0	0	0	0	0
Sample Depth to Bottom of Sample ⁽¹⁾	0	0	0	0	0
Sample Date	5/6/2004	5/6/2004	5/6/2004	5/6/2004	5/6/2004
QC Code	SA	SA	SA	SA	SA
Study ID	ENSR IRM	ENSR IRM	ENSR IRM	ENSR IRM	ENSR IRM
Sample Round	1	1	1	1	1

Parameter	Units	Maximum Value	Frequency of Detection	NYSDEC TAGM 4046 ⁽²⁾	Number of Exceedances	Number of Detects	Number of Analyses ⁽³⁾	Value (Q)	Value (Q)	Value (Q)	Value (Q)	Value (Q)
Styrene	UG/KG	0	0%		0	0	107					
Tetrachloroethene	UG/KG	6.4	3%	1400	0	5	177	6.2 U	6 U	6 U	5.9 U	5.8 U
Toluene	UG/KG	8	8%	1500	0	14	177	6.2 U	6 U	6 U	5.9 U	5.8 U
Total BTEX	MG/KG	3.25	67%		0	2	3					
Total Xylenes	UG/KG	3	7%	1200	0	7	102					
Trans-1,2-Dichloroethene	UG/KG	0	0%	300	0	0	168	6.2 U	6 U	6 U	5.9 U	5.8 U
Trans-1,3-Dichloropropene	UG/KG	0	0%		0	0	107					
Trichloroethene	UG/KG	4.5	5%	700	0	8	177	6.2 U	6 U	6 U	5.9 U	5.8 U
Trichlorofluoromethane	UG/KG	6	1%		0	1	98					
Vinyl chloride	UG/KG	0	0%	200	0	0	177	12 U	12 U	12 U	12 U	12 U
Semivolatile Organics												
1,1'-Biphenyl	UG/KG	254.5	2%		0	2	99					
1,2,4-Trichlorobenzene	UG/KG	0	0%	3400	0	0	9					
1,2-Dichlorobenzene	UG/KG	0	0%	7900	0	0	9					
1,3-Dichlorobenzene	UG/KG	0	0%	1600	0	0	9					
1,4-Dichlorobenzene	UG/KG	0	0%	8500	0	0	9					
2,2'-oxybis(1-Chloropropane)	UG/KG	0	0%		0	0	105					
2,4,5-Trichlorophenol	UG/KG	0	0%	100	0	0	178	2000 U	2000 U	2000 U	1900 U	1900 U
2,4,6-Trichlorophenol	UG/KG	0	0%		0	0	178	2000 U	2000 U	2000 U	1900 U	1900 U
2,4-Dichlorophenol	UG/KG	0	0%	400	0	0	178	2000 U	2000 U	2000 U	1900 U	1900 U
2,4-Dimethylphenol	UG/KG	0	0%		0	0	108					
2,4-Dinitrophenol	UG/KG	0	0%	200	0	0	178	11000 U	10000 U	10000 U	10000 U	9800 U
2,4-Dinitrotoluene	UG/KG	0	0%		0	0	178	2000 U	2000 U	2000 U	1900 U	1900 U
2,6-Dinitrotoluene	UG/KG	0	0%	1000	0	0	178	2000 U	2000 U	2000 U	1900 U	1900 U
2-Chloronaphthalene	UG/KG	0	0%		0	0	108					
2-Chlorophenol	UG/KG	0	0%	800	0	0	178	2000 U	2000 U	2000 U	1900 U	1900 U
2-Methylnaphthalene	UG/KG	1295	19%	36400	0	34	178	2000 U	2000 U	2000 U	1900 U	1900 U
2-Methylphenol	UG/KG	0	0%	100	0	0	178	2000 U	2000 U	2000 U	1900 U	1900 U
2-Nitroaniline	UG/KG	0	0%	430	0	0	178	11000 U	10000 U	10000 U	10000 U	9800 U
2-Nitrophenol	UG/KG	0	0%	330	0	0	178	2000 U	2000 U	2000 U	1900 U	1900 U
3,3'-Dichlorobenzidine	UG/KG	0	0%		0	0	178	2000 U	2000 U	2000 U	1900 U	1900 U
3-Nitroaniline	UG/KG	0	0%	500	0	0	178	11000 U	10000 U	10000 U	10000 U	9800 U
4,6-Dinitro-2-methylphenol	UG/KG	0	0%		0	0	108					
4-Bromophenyl phenyl ether	UG/KG	0	0%		0	0	108					
4-Chloro-3-methylphenol	UG/KG	0	0%	240	0	0	178	2000 U	2000 U	2000 U	1900 U	1900 U
4-Chloroaniline	UG/KG	1200	1%	220	1	2	178	2000 U	2000 U	2000 U	1900 U	1900 U
4-Chlorophenyl phenyl ether	UG/KG	0	0%		0	0	108					
4-Methylphenol	UG/KG	150	3%	900	0	5	178	2000 U	2000 U	2000 U	1900 U	1900 U
4-Nitroaniline	UG/KG	0	0%		0	0	108					
4-Nitrophenol	UG/KG	0	0%	100	0	0	178	11000 U	10000 U	10000 U	10000 U	9800 U
Acenaphthene	UG/KG	2680	24%	50000	0	42	178	2000 U	2000 U	2000 U	390 J	350 J
Acenaphthylene	UG/KG	1700	37%	41000	0	66	178	300 J	430 J	920 J	1300 J	1400 J
Acetophenone	UG/KG	0	0%		0	0	99					
Aniline	UG/KG	0	0%		0	0	70	2000 U	2000 U	2000 U	1900 U	1900 U
Anthracene	UG/KG	4395	43%	50000	0	77	178	570 J	440 J	610 J	1200 J	1400 J

Table A-2A
SURFACE SOIL SAMPLE RESULTS (0-2 ft.)
SEAD-59
SEAD-59 and SEAD-71 Phase II RI Report
Seneca Army Depot Activity

Facility	SEAD-59	SEAD-59	SEAD-59	SEAD-59	SEAD-59							
Location ID	WS-59-01-015-1	WS-59-01-015-10	WS-59-01-015-11	WS-59-01-015-18	WS-59-01-015-19							
Matrix	SOIL	SOIL	SOIL	SOIL	SOIL							
Sample ID	WS-59-01-015-1	WS-59-01-015-10	WS-59-01-015-11	WS-59-01-015-18	WS-59-01-015-19							
Sample Depth to Top of Sample ⁽¹⁾	0	0	0	0	0							
Sample Depth to Bottom of Sample ⁽¹⁾	0	0	0	0	0							
Sample Date	5/6/2004	5/6/2004	5/6/2004	5/6/2004	5/6/2004							
QC Code	SA	SA	SA	SA	SA							
Study ID	ENSR IRM	ENSR IRM	ENSR IRM	ENSR IRM	ENSR IRM							
Sample Round	1	1	1	1	1							
Parameter	Units	Maximum Value	Frequency of Detection	NYSDEC TAGM 4046 ⁽²⁾	Number of Exceedances	Number of Detects	Number of Analyses ⁽³⁾	Value (Q)	Value (Q)	Value (Q)	Value (Q)	Value (Q)
Atrazine	UG/KG	120	1%		0	1	99					
Benzaldehyde	UG/KG	50	1%		0	1	99					
Benzo(a)anthracene	UG/KG	8900	51%	224	72	90	178	3000	1700 J	1900 J	3100	3600
Benzo(a)pyrene	UG/KG	8050	51%	61	84	91	178	2700	2000	2300	3600	3800
Benzo(b)fluoranthene	UG/KG	6800	52%	1100	40	92	178	2100	1500 J	1800 J	2900	2900
Benzo(ghi)perylene	UG/KG	5200	46%	50000	0	82	178	1700 J	1200 J	1500 J	1900 J	1900
Benzo(k)fluoranthene	UG/KG	7350	49%	1100	35	88	178	2500	1600 J	1800 J	3000	3100
Benzoic Acid	UG/KG	0	0%	2700	0	0	70	11000 U	10000 U	10000 U	10000 U	9800 U
Bis(2-Chloroethoxy)methane	UG/KG	0	0%		0	0	108					
Bis(2-Chloroethyl)ether	UG/KG	0	0%		0	0	108					
Bis(2-Chloroisopropyl)ether	UG/KG	0	0%		0	0	3					
Bis(2-Ethylhexyl)phthalate	UG/KG	990	19%	50000	0	34	178	2000 U	2000 U	2000 U	1900 U	1900 U
Butylbenzylphthalate	UG/KG	0	0%	50000	0	0	178	2000 U	2000 U	2000 U	1900 UJ	1900 UJ
Caprolactam	UG/KG	0	0%		0	0	99					
Carbazole	UG/KG	755	19%		0	20	108					
Chrysene	UG/KG	8900	51%	400	62	91	178	2900	1700 NJ	1900 NJ	3500	3600
Di-n-butylphthalate	UG/KG	965	2%	8100	0	4	178	2000 U	2000 U	2000 U	1900 U	1900 U
Di-n-octylphthalate	UG/KG	0	0%	50000	0	0	178	2000 U	2000 U	2000 U	1900 U	1900 U
Dibenz(a,h)anthracene	UG/KG	1665	38%	14	67	68	178	580 J	390 J	450 J	660 J	660 J
Dibenzofuran	UG/KG	2350	16%	6200	0	28	178	2000 U	2000 U	2000 U	240 J	210 J
Diethyl phthalate	UG/KG	10	1%	7100	0	1	178	2000 U	2000 U	2000 U	1900 U	1900 U
Dimethylphthalate	UG/KG	0	0%	2000	0	0	178	2000 U	2000 U	2000 U	1900 U	1900 U
Fluoranthene	UG/KG	23500	54%	50000	0	97	178	4600	2800	3200	7000	7000
Fluorene	UG/KG	2640	28%	50000	0	49	178	2000 U	2000 U	2000 U	510 J	530 J
Hexachlorobenzene	UG/KG	0	0%	410	0	0	178	2000 U	2000 U	2000 U	1900 U	1900 U
Hexachlorobutadiene	UG/KG	0	0%		0	0	178	2000 U	2000 U	2000 U	1900 U	1900 U
Hexachlorocyclopentadiene	UG/KG	0	0%		0	0	108					
Hexachloroethane	UG/KG	0	0%		0	0	178	2000 U	2000 U	2000 U	1900 U	1900 U
Indeno(1,2,3-cd)pyrene	UG/KG	4950	47%	3200	2	84	178	1500 J	1100 J	1400 J	1800 J	1800 J
Isophorone	UG/KG	0	0%	4400	0	0	178	2000 U	2000 U	2000 U	1900 U	1900 U
N-Nitrosodiphenylamine	UG/KG	100	1%		0	1	108					
N-Nitrosodipropylamine	UG/KG	0	0%		0	0	108					
Naphthalene	UG/KG	1800	19%	13000	0	34	178	2000 U	2000 U	260 J	1900 U	1900 U
Nitrobenzene	UG/KG	0	0%	200	0	0	178	2000 U	2000 U	2000 U	1900 U	1900 U
Pentachlorophenol	UG/KG	0	0%	1000	0	0	178	11000 U	10000 U	10000 U	10000 U	9800 U
Phenanthrene	UG/KG	21300	51%	50000	0	90	178	1700 J	880 J	1400 J	4300	3300
Phenol	UG/KG	0	0%	30	0	0	178	2000 U	2000 U	2000 U	1900 U	1900 U
Pyrene	UG/KG	19200	55%	50000	0	98	178	5100	2600	3200	5900 J	6400 J
Pyridine	UG/KG	0	0%		0	0	100	11000 U	10000 U	10000 U	10000 U	9800 U
Total Unknown PAHs as SV	MG/KG	25	100%		0	3	3					
Pesticides/PCBs												
4,4'-DDD	UG/KG	740	28%	2900	0	49	178	20 U	20 U	36 J	89	39 J
4,4'-DDE	UG/KG	2600	37%	2100	1	65	178	20 U	20 U	20 U	39 J	25
4,4'-DDT	UG/KG	3700	33%	2100	1	59	178	20 U	20 U	30 J	92	38 J
Aldrin	UG/KG	1.2	1%	41	0	1	178	11 U	10 U	10 U	10 U	9.8 U

**Table A-2A
SURFACE SOIL SAMPLE RESULTS (0-2 ft.)
SEAD-59
SEAD-59 and SEAD-71 Phase II RI Report
Seneca Army Depot Activity**

Facility	SEAD-59	SEAD-59	SEAD-59	SEAD-59	SEAD-59							
Location ID	WS-59-01-015-1	WS-59-01-015-10	WS-59-01-015-11	WS-59-01-015-18	WS-59-01-015-19							
Matrix	SOIL	SOIL	SOIL	SOIL	SOIL							
Sample ID	WS-59-01-015-1	WS-59-01-015-10	WS-59-01-015-11	WS-59-01-015-18	WS-59-01-015-19							
Sample Depth to Top of Sample ⁽¹⁾	0	0	0	0	0							
Sample Depth to Bottom of Sample ⁽¹⁾	0	0	0	0	0							
Sample Date	5/6/2004	5/6/2004	5/6/2004	5/6/2004	5/6/2004							
QC Code	SA	SA	SA	SA	SA							
Study ID	ENSR IRM	ENSR IRM	ENSR IRM	ENSR IRM	ENSR IRM							
Sample Round	1	1	1	1	1							
Parameter	Units	Maximum Value	Frequency of Detection	NYSDEC TAGM 4046 ⁽²⁾	Number of Exceedances	Number of Detects	Number of Analyses ⁽³⁾	Value (Q)	Value (Q)	Value (Q)	Value (Q)	Value (Q)
Alpha-BHC	UG/KG	0	0%	110	0	0	178	11 U	10 U	10 U	10 U	9.8 U
Alpha-Chlordane	UG/KG	34	4%		0	7	178	11 U	10 U	10 U	10 U	9.8 U
Beta-BHC	UG/KG	2.4	1%	200	0	1	178	11 U	10 U	10 U	10 U	9.8 U
Delta-BHC	UG/KG	0	0%	300	0	0	178	11 U	10 U	10 U	10 U	9.8 U
Dieldrin	UG/KG	0	0%	44	0	0	178	20 U	20 U	20 U	19 U	19 U
Endosulfan I	UG/KG	16	1%	900	0	1	178	11 U	10 U	10 U	10 U	9.8 U
Endosulfan II	UG/KG	0	0%	900	0	0	178	20 U	20 U	20 U	19 U	19 U
Endosulfan sulfate	UG/KG	6.2	1%	1000	0	1	178	20 U	20 U	20 U	19 U	19 U
Endrin	UG/KG	16	2%	100	0	3	178	20 U	20 U	20 U	19 U	19 U
Endrin aldehyde	UG/KG	4.9	1%		0	2	178	20 U	20 U	20 U	19 U	19 U
Endrin ketone	UG/KG	38	2%		0	4	178	20 U	20 U	20 U	19 U	19 U
Gamma-BHC/Lindane	UG/KG	0	0%	60	0	0	178	11 U	10 U	10 U	10 U	9.8 U
Gamma-Chlordane	UG/KG	24	8%	540	0	14	178	11 U	10 U	10 U	10 U	9.8 U
Heptachlor	UG/KG	0	0%	100	0	0	178	11 U	10 U	10 U	10 U	9.8 U
Heptachlor epoxide	UG/KG	3	1%	20	0	2	178	11 U	10 U	10 U	10 U	9.8 U
Methoxychlor	UG/KG	0	0%		0	0	178	110 U	100 U	100 U	100 U	98 U
Toxaphene	UG/KG	0	0%		0	0	178	200 U	200 U	200 U	190 U	190 U
Aroclor-1016	UG/KG	0	0%		0	0	178	41 U	40 U	39 U	39 U	38 U
Aroclor-1221	UG/KG	0	0%		0	0	178	41 U	40 U	39 U	39 U	38 U
Aroclor-1232	UG/KG	0	0%		0	0	178	41 U	40 U	39 U	39 U	38 U
Aroclor-1242	UG/KG	0	0%		0	0	178	41 U	40 U	39 U	39 U	38 U
Aroclor-1248	UG/KG	0	0%		0	0	178	41 U	40 U	39 U	39 U	38 U
Aroclor-1254	UG/KG	0	0%	10000	0	0	178	41 U	40 U	39 U	39 U	38 U
Aroclor-1260	UG/KG	79	1%	10000	0	2	178	41 U	40 U	39 U	39 U	38 U
Metals												
Aluminum	MG/KG	18300	100%	19300	0	178	178	11800	9840	10200	12900	11200
Antimony	MG/KG	424	58%	5.9	5	104	178	3.7 UJ	3.6 UJ	11.1 J	7.9	3.2 U
Arsenic	MG/KG	32.2	100%	8.2	7	178	178	5	4.2	4.7	4.3	4.7
Barium	MG/KG	304	100%	300	1	178	178	102	91.3	104	135	96.5
Beryllium	MG/KG	2.6	99%	1.1	2	176	178	0.29	0.29	0.29	0.4	0.3
Cadmium	MG/KG	3.2	86%	2.3	2	153	178	0.69	0.65	0.66	0.59	0.48 J
Calcium	MG/KG	214000	100%	121000	1	178	178	27800	65400	41600	63200	86800
Chromium	MG/KG	39.3	100%	29.6	2	178	178	19.3	16	16.9	20.4	17.9
Cobalt	MG/KG	47.8	100%	30	2	178	178	11.2	8.5	9	9.9	10
Copper	MG/KG	305	100%	33	19	178	178	26.6	26.1	22.8	32.6	30.8
Cyanide	MG/KG	0	0%	0.35	0	0	9					
Iron	MG/KG	64000	100%	36500	1	178	178	22400	19400	19800	21500	20100
Lead	MG/KG	164	100%	24.8	75	178	178	21.1 J	27.4 J	31.8 J	57.7 J	80.8 J
Magnesium	MG/KG	30200	100%	21500	3	178	178	8170	7780	7200	7630	8930
Manganese	MG/KG	1290	100%	1060	3	178	178	617	466	446	568	492
Mercury	MG/KG	0.95	95%	0.1	37	169	178	0.08	0.06	0.02 J	0.08	0.04
Nickel	MG/KG	88.3	100%	49	3	178	178	31.4	25.5	25	27.5	27.7
Potassium	MG/KG	2290	100%	2380	0	178	178	1210	1060	1020	1210	1150
Selenium	MG/KG	1.5	9%	2	0	16	178	0.61 UJ	0.59 UJ	0.57 UJ	0.57 U	0.54 U
Silver	MG/KG	2.9	49%	0.75	62	87	178	0.61 UJ	0.59 UJ	0.57 UJ	0.57 U	0.54 U

**Table A-2A
SURFACE SOIL SAMPLE RESULTS (0-2 ft.)
SEAD-59
SEAD-59 and SEAD-71 Phase II RI Report
Seneca Army Depot Activity**

Facility	SEAD-59	SEAD-59	SEAD-59	SEAD-59	SEAD-59
Location ID	WS-59-01-015-1	WS-59-01-015-10	WS-59-01-015-11	WS-59-01-015-18	WS-59-01-015-19
Matrix	SOIL	SOIL	SOIL	SOIL	SOIL
Sample ID	WS-59-01-015-1	WS-59-01-015-10	WS-59-01-015-11	WS-59-01-015-18	WS-59-01-015-19
Sample Depth to Top of Sample ⁽¹⁾	0	0	0	0	0
Sample Depth to Bottom of Sample ⁽¹⁾	0	0	0	0	0
Sample Date	5/6/2004	5/6/2004	5/6/2004	5/6/2004	5/6/2004
QC Code	SA	SA	SA	SA	SA
Study ID	ENSR IRM	ENSR IRM	ENSR IRM	ENSR IRM	ENSR IRM
Sample Round	1	1	1	1	1

Parameter	Units	Maximum Value	Frequency of Detection	NYSDEC TAGM 4046 ⁽²⁾	Number of Exceedances	Number of Detects	Number of Analyses ⁽³⁾	Value (Q)	Value (Q)	Value (Q)	Value (Q)	Value (Q)
Sodium	MG/KG	4060	99%	172	86	177	178	300	267	120	130	106
Thallium	MG/KG	1.8	29%	0.7	24	51	178	0.84 J	0.63 J	0.57 U	0.91 J	0.86 J
Vanadium	MG/KG	28.5	100%	150	0	178	178	19.4	16.4	17.9	22	20
Zinc	MG/KG	341	100%	110	19	178	178	74.5 J	67.5 J	80.6 J	115 J	77.6 J

Note(s):

- (1) - Historical sample depths are presented (I.e. prior to 2002 TCRA)
- (2) - NYSDEC Technical and Administrative Guidance Memorandum (TAGM) HWR-94-4046, Revised January 24, 1994
- (3) - Sample/Duplicate pair are presented as individual samples in this table. Statistical information used Sample Duplicate pairs as a single entity and averaged result values were used in risk assessment analysis.

U = compound was not detected

J = the reported value is an estimated concentration

UJ = the compound was not detected; the associated reporting limit is approximate

R = the data was rejected in the data validating process

NJ = compound was "tentatively identified" and the associated numerical value is approximate

Table A-2A
SURFACE SOIL SAMPLE RESULTS (0-2 ft.)
SEAD-59
SEAD-59 and SEAD-71 Phase II RI Report
Seneca Army Depot Activity

Facility	SEAD-59	SEAD-59	SEAD-59	SEAD-59	SEAD-59
Location ID	WS-59-01-015-2	WS-59-01-015-5	WS-59-01-015-6	WS-59-01-015-7	WS-59-01-015-9
Matrix	SOIL	SOIL	SOIL	SOIL	SOIL
Sample ID	WS-59-01-015-2	WS-59-01-015-5	WS-59-01-015-6	WS-59-01-015-7	WS-59-01-015-9
Sample Depth to Top of Sample ⁽¹⁾	0	0	0	0	0
Sample Depth to Bottom of Sample ⁽¹⁾	0	0	0	0	0
Sample Date	5/6/2004	5/6/2004	5/6/2004	5/6/2004	5/6/2004
QC Code	SA	SA	SA	SA	SA
Study ID	ENSR IRM	ENSR IRM	ENSR IRM	ENSR IRM	ENSR IRM
Sample Round	1	1	1	1	1

Parameter	Units	Maximum Value	Frequency of Detection	NYSDEC TAGM 4046 ⁽²⁾	Number of Exceedances	Number of Detects	Number of Analyses ⁽³⁾	Value (Q)	Value (Q)	Value (Q)	Value (Q)	Value (Q)
Volatile Organics												
1,1,1-Trichloroethane	UG/KG	0	0%	800	0	0	177	5.9 U	6 U	6 U	6.2 U	5.9 U
1,1,2,2-Tetrachloroethane	UG/KG	0	0%	600	0	0	169	5.9 U	6 U	6 U	6.2 U	5.9 U
1,1,2-Trichloro-1,2,2-Trifluoroethane	UG/KG	0	0%		0	0	168	5.9 U	6 U	6 U	6.2 U	5.9 U
1,1,2-Trichloroethane	UG/KG	0	0%		0	0	107					
1,1-Dichloroethane	UG/KG	0	0%	200	0	0	177	5.9 U	6 U	6 U	6.2 U	5.9 U
1,1-Dichloroethene	UG/KG	8	2%	400	0	3	177	5.9 U	6 U	6 U	6.2 U	5.9 U
1,2,3-Trichloropropane	UG/KG	0	0%		0	0	70	5.9 U	6 U	6 U	6.2 U	5.9 U
1,2,4-Trichlorobenzene	UG/KG	0	0%	3400	0	0	161	5.9 U	6 U	6 U	6.2 U	5.9 U
1,2-Dibromo-3-chloropropane	UG/KG	0	0%		0	0	91					
1,2-Dibromoethane	UG/KG	0	0%		0	0	98					
1,2-Dichlorobenzene	UG/KG	0	0%	7900	0	0	161	5.9 U	6 U	6 U	6.2 U	5.9 U
1,2-Dichloroethane	UG/KG	0	0%	100	0	0	177	5.9 U	6 U	6 U	6.2 U	5.9 U
1,2-Dichloroethene (total)	UG/KG	0	0%		0	0	9					
1,2-Dichloropropane	UG/KG	0	0%		0	0	107					
1,3-Dichlorobenzene	UG/KG	0	0%	1600	0	0	161	5.9 U	6 U	6 U	6.2 U	5.9 U
1,3-Dichloropropane	UG/KG	0	0%		0	0	70	5.9 U	6 U	6 U	6.2 U	5.9 U
1,4-Dichlorobenzene	UG/KG	0	0%	8500	0	0	161	5.9 U	6 U	6 U	6.2 U	5.9 U
Acetone	UG/KG	550	27%	200	2	47	177	24 U	24 U	24 U	25 U	24 U
Benzene	UG/KG	3	4%	60	0	7	177	5.9 U	6 U	6 U	6.2 U	5.9 U
Bromodichloromethane	UG/KG	0	0%		0	0	107					
Bromoform	UG/KG	0	0%		0	0	107					
Carbon disulfide	UG/KG	4	3%	2700	0	6	177	5.9 U	6 U	6 U	6.2 U	5.9 U
Carbon tetrachloride	UG/KG	0	0%	600	0	0	177	5.9 U	6 U	6 U	6.2 U	5.9 U
Chlorobenzene	UG/KG	0	0%	1700	0	0	177	5.9 U	6 U	6 U	6.2 U	5.9 U
Chlorodibromomethane	UG/KG	0	0%		0	0	177	5.9 U	6 U	6 U	6.2 U	5.9 U
Chloroethane	UG/KG	0	0%	1900	0	0	177	12 U	12 U	12 U	12 U	12 U
Chloroform	UG/KG	0	0%	300	0	0	177	5.9 U	6 U	6 U	6.2 U	5.9 U
Cis-1,2-Dichloroethene	UG/KG	0	0%		0	0	98					
Cis-1,3-Dichloropropene	UG/KG	0	0%		0	0	107					
Cyclohexane	UG/KG	3	8%		0	8	98					
Dichlorodifluoromethane	UG/KG	0	0%		0	0	98					
Ethyl benzene	UG/KG	4.6	1%	5500	0	2	177	5.9 U	6 U	6 U	6.2 U	5.9 U
Isopropylbenzene	UG/KG	0	0%		0	0	98					
Meta/Para Xylene	UG/KG	9.4	4%		0	3	70	5.9 U	6 U	6 U	6.2 U	5.9 U
Methyl Acetate	UG/KG	2	3%		0	3	98					
Methyl Tertbutyl Ether	UG/KG	0	0%		0	0	98					
Methyl bromide	UG/KG	0	0%		0	0	107					
Methyl butyl ketone	UG/KG	0	0%		0	0	107					
Methyl chloride	UG/KG	0	0%		0	0	107					
Methyl cyclohexane	UG/KG	5	10%		0	10	98					
Methyl ethyl ketone	UG/KG	190	12%	300	0	22	177	12 U	12 U	12 U	12 U	12 U
Methyl isobutyl ketone	UG/KG	1.9	1%	1000	0	1	177	12 U	12 U	12 U	12 U	12 U
Methylene chloride	UG/KG	4.9	20%	100	0	36	178	5.9 U	6 U	6 U	6.2 U	5.9 U
Ortho Xylene	UG/KG	5.05	4%		0	3	70	5.9 U	6 U	6 U	6.2 U	5.9 U

**Table A-2A
SURFACE SOIL SAMPLE RESULTS (0-2 ft.)
SEAD-59
SEAD-59 and SEAD-71 Phase II RI Report
Seneca Army Depot Activity**

Facility	SEAD-59	SEAD-59	SEAD-59	SEAD-59	SEAD-59
Location ID	WS-59-01-015-2	WS-59-01-015-5	WS-59-01-015-6	WS-59-01-015-7	WS-59-01-015-9
Matrix	SOIL	SOIL	SOIL	SOIL	SOIL
Sample ID	WS-59-01-015-2	WS-59-01-015-5	WS-59-01-015-6	WS-59-01-015-7	WS-59-01-015-9
Sample Depth to Top of Sample ⁽¹⁾	0	0	0	0	0
Sample Depth to Bottom of Sample ⁽¹⁾	0	0	0	0	0
Sample Date	5/6/2004	5/6/2004	5/6/2004	5/6/2004	5/6/2004
QC Code	SA	SA	SA	SA	SA
Study ID	ENSR IRM	ENSR IRM	ENSR IRM	ENSR IRM	ENSR IRM
Sample Round	1	1	1	1	1

Parameter	Units	Maximum Value	Frequency of Detection	NYSDEC TAGM 4046 ⁽²⁾	Number of Exceedances	Number of Detects	Number of Analyses ⁽³⁾	Value (Q)	Value (Q)	Value (Q)	Value (Q)	Value (Q)
Styrene	UG/KG	0	0%		0	0	107					
Tetrachloroethene	UG/KG	6.4	3%	1400	0	5	177	5.9 U	6 U	6 U	6.2 U	5.9 U
Toluene	UG/KG	8	8%	1500	0	14	177	5.9 U	6 U	6 U	6.2 U	5.9 U
Total BTEX	MG/KG	3.25	67%		0	2	3					
Total Xylenes	UG/KG	3	7%	1200	0	7	102					
Trans-1,2-Dichloroethene	UG/KG	0	0%	300	0	0	168	5.9 U	6 U	6 U	6.2 U	5.9 U
Trans-1,3-Dichloropropene	UG/KG	0	0%		0	0	107					
Trichloroethene	UG/KG	4.5	5%	700	0	8	177	5.9 U	6 U	6 U	6.2 U	5.9 U
Trichlorofluoromethane	UG/KG	6	1%		0	1	98					
Vinyl chloride	UG/KG	0	0%	200	0	0	177	12 U	12 U	12 U	12 U	12 U
Semivolatile Organics												
1,1'-Biphenyl	UG/KG	254.5	2%		0	2	99					
1,2,4-Trichlorobenzene	UG/KG	0	0%	3400	0	0	9					
1,2-Dichlorobenzene	UG/KG	0	0%	7900	0	0	9					
1,3-Dichlorobenzene	UG/KG	0	0%	1600	0	0	9					
1,4-Dichlorobenzene	UG/KG	0	0%	8500	0	0	9					
2,2'-oxybis(1-Chloropropane)	UG/KG	0	0%		0	0	105					
2,4,5-Trichlorophenol	UG/KG	0	0%	100	0	0	178	2000 U	2000 U	2000 U	2000 U	2000 U
2,4,6-Trichlorophenol	UG/KG	0	0%		0	0	178	2000 U	2000 U	2000 U	2000 U	2000 U
2,4-Dichlorophenol	UG/KG	0	0%	400	0	0	178	2000 U	2000 U	2000 U	2000 U	2000 U
2,4-Dimethylphenol	UG/KG	0	0%		0	0	108					
2,4-Dinitrophenol	UG/KG	0	0%	200	0	0	178	10000 U	10000 U	10000 U	11000 U	10000 U
2,4-Dinitrotoluene	UG/KG	0	0%		0	0	178	2000 U	2000 U	2000 U	2000 U	2000 U
2,6-Dinitrotoluene	UG/KG	0	0%	1000	0	0	178	2000 U	2000 U	2000 U	2000 U	2000 U
2-Chloronaphthalene	UG/KG	0	0%		0	0	108					
2-Chlorophenol	UG/KG	0	0%	800	0	0	178	2000 U	2000 U	2000 U	2000 U	2000 U
2-Methylnaphthalene	UG/KG	1295	19%	36400	0	34	178	2000 U	2000 U	2000 U	2000 U	330 J
2-Methylphenol	UG/KG	0	0%	100	0	0	178	2000 U	2000 U	2000 U	2000 U	2000 U
2-Nitroaniline	UG/KG	0	0%	430	0	0	178	10000 U	10000 U	10000 U	11000 U	10000 U
2-Nitrophenol	UG/KG	0	0%	330	0	0	178	2000 U	2000 U	2000 U	2000 U	2000 U
3,3'-Dichlorobenzidine	UG/KG	0	0%		0	0	178	2000 U	2000 U	2000 U	2000 U	2000 U
3-Nitroaniline	UG/KG	0	0%	500	0	0	178	10000 U	10000 U	10000 U	11000 U	10000 U
4,6-Dinitro-2-methylphenol	UG/KG	0	0%		0	0	108					
4-Bromophenyl phenyl ether	UG/KG	0	0%		0	0	108					
4-Chloro-3-methylphenol	UG/KG	0	0%	240	0	0	178	2000 U	2000 U	2000 U	2000 U	2000 U
4-Chloroaniline	UG/KG	1200	1%	220	1	2	178	2000 U	2000 U	2000 U	2000 U	2000 U
4-Chlorophenyl phenyl ether	UG/KG	0	0%		0	0	108					
4-Methylphenol	UG/KG	150	3%	900	0	5	178	2000 U	2000 U	2000 U	2000 U	2000 U
4-Nitroaniline	UG/KG	0	0%		0	0	108					
4-Nitrophenol	UG/KG	0	0%	100	0	0	178	10000 U	10000 U	10000 U	11000 U	10000 U
Acenaphthene	UG/KG	2680	24%	50000	0	42	178	2000 U	2000 U	2000 U	230 J	2000 U
Acenaphthylene	UG/KG	1700	37%	41000	0	66	178	440 J	540 J	580 J	350 J	660 J
Acetophenone	UG/KG	0	0%		0	0	99					
Aniline	UG/KG	0	0%		0	0	70	2000 U	2000 U	2000 U	2000 U	2000 U
Anthracene	UG/KG	4395	43%	50000	0	77	178	450 J	640 J	930 J	550 J	560 J

Table A-2A
SURFACE SOIL SAMPLE RESULTS (0-2 ft.)
SEAD-59
SEAD-59 and SEAD-71 Phase II RI Report
Seneca Army Depot Activity

Facility	SEAD-59	SEAD-59	SEAD-59	SEAD-59	SEAD-59							
Location ID	WS-59-01-015-2	WS-59-01-015-5	WS-59-01-015-6	WS-59-01-015-7	WS-59-01-015-9							
Matrix	SOIL	SOIL	SOIL	SOIL	SOIL							
Sample ID	WS-59-01-015-2	WS-59-01-015-5	WS-59-01-015-6	WS-59-01-015-7	WS-59-01-015-9							
Sample Depth to Top of Sample ⁽¹⁾	0	0	0	0	0							
Sample Depth to Bottom of Sample ⁽¹⁾	0	0	0	0	0							
Sample Date	5/6/2004	5/6/2004	5/6/2004	5/6/2004	5/6/2004							
QC Code	SA	SA	SA	SA	SA							
Study ID	ENSR IRM	ENSR IRM	ENSR IRM	ENSR IRM	ENSR IRM							
Sample Round	1	1	1	1	1							
Parameter	Units	Maximum Value	Frequency of Detection	NYSDEC TAGM 4046 ⁽²⁾	Number of Exceedances	Number of Detects	Number of Analyses ⁽³⁾	Value (Q)	Value (Q)	Value (Q)	Value (Q)	Value (Q)
Atrazine	UG/KG	120	1%		0	1	99					
Benzaldehyde	UG/KG	50	1%		0	1	99					
Benzo(a)anthracene	UG/KG	8900	51%	224	72	90	178	1900 J	2200	2700	1700 J	1900 J
Benzo(a)pyrene	UG/KG	8050	51%	61	84	91	178	2000	2500	2900	1800 J	2400
Benzo(b)fluoranthene	UG/KG	6800	52%	1100	40	92	178	1700 J	2000 J	2200	1400 J	1900 J
Benzo(ghi)perylene	UG/KG	5200	46%	50000	0	82	178	1400 J	1700 J	1900 J	1100 J	1500 J
Benzo(k)fluoranthene	UG/KG	7350	49%	1100	35	88	178	1700 J	2100	2300	1400 J	1800 J
Benzoic Acid	UG/KG	0	0%	2700	0	0	70	10000 U	10000 U	10000 U	11000 U	10000 U
Bis(2-Chloroethoxy)methane	UG/KG	0	0%		0	0	108					
Bis(2-Chloroethyl)ether	UG/KG	0	0%		0	0	108					
Bis(2-Chloroisopropyl)ether	UG/KG	0	0%		0	0	3					
Bis(2-Ethylhexyl)phthalate	UG/KG	990	19%	50000	0	34	178	2000 U	2000 U	2000 U	2000 U	2000 U
Butylbenzylphthalate	UG/KG	0	0%	50000	0	0	178	2000 U	2000 U	2000 U	2000 U	2000 U
Caprolactam	UG/KG	0	0%		0	0	99					
Carbazole	UG/KG	755	19%		0	20	108					
Chrysene	UG/KG	8900	51%	400	62	91	178	1900 NJ	2300	2700 NJ	1800 NJ	2000
Di-n-butylphthalate	UG/KG	965	2%	8100	0	4	178	2000 U	2000 U	2000 U	2000 U	2000 U
Di-n-octylphthalate	UG/KG	0	0%	50000	0	0	178	2000 U	2000 U	2000 U	2000 U	2000 U
Dibenz(a,h)anthracene	UG/KG	1665	38%	14	67	68	178	410 J	500 J	590 J	360 J	490 J
Dibenzofuran	UG/KG	2350	16%	6200	0	28	178	2000 U	2000 U	2000 U	2000 U	2000 U
Diethyl phthalate	UG/KG	10	1%	7100	0	1	178	2000 U	2000 U	2000 U	2000 U	2000 U
Dimethylphthalate	UG/KG	0	0%	2000	0	0	178	2000 U	2000 U	2000 U	2000 U	2000 U
Fluoranthene	UG/KG	23500	54%	50000	0	97	178	3500	3600	4700	3400	3100
Fluorene	UG/KG	2640	28%	50000	0	49	178	2000 U	2000 U	310 J	2000 U	2000 U
Hexachlorobenzene	UG/KG	0	0%	410	0	0	178	2000 U	2000 U	2000 U	2000 U	2000 U
Hexachlorobutadiene	UG/KG	0	0%		0	0	178	2000 U	2000 U	2000 U	2000 U	2000 U
Hexachlorocyclopentadiene	UG/KG	0	0%		0	0	108					
Hexachloroethane	UG/KG	0	0%		0	0	178	2000 U	2000 U	2000 U	2000 U	2000 U
Indeno(1,2,3-cd)pyrene	UG/KG	4950	47%	3200	2	84	178	1200 J	1600 J	1800 J	1100 J	1400 J
Isophorone	UG/KG	0	0%	4400	0	0	178	2000 U	2000 U	2000 U	2000 U	2000 U
N-Nitrosodiphenylamine	UG/KG	100	1%		0	1	108					
N-Nitrosodipropylamine	UG/KG	0	0%		0	0	108					
Naphthalene	UG/KG	1800	19%	13000	0	34	178	2000 U	2000 U	2000 U	2000 U	2000 U
Nitrobenzene	UG/KG	0	0%	200	0	0	178	2000 U	2000 U	2000 U	2000 U	2000 U
Pentachlorophenol	UG/KG	0	0%	1000	0	0	178	10000 U	10000 U	10000 U	11000 U	10000 U
Phenanthrene	UG/KG	21300	51%	50000	0	90	178	960 J	1200 J	2400	1400 J	1100 J
Phenol	UG/KG	0	0%	30	0	0	178	2000 U	2000 U	2000 U	2000 U	2000 U
Pyrene	UG/KG	19200	55%	50000	0	98	178	3100	3700	4200	2900	3000
Pyridine	UG/KG	0	0%		0	0	100	10000 U	10000 U	10000 U	11000 U	10000 U
Total Unknown PAHs as SV	MG/KG	25	100%		0	3	3					
Pesticides/PCBs												
4,4'-DDD	UG/KG	740	28%	2900	0	49	178	20 U	20 U	20 U	20 U	20 U
4,4'-DDE	UG/KG	2600	37%	2100	1	65	178	20 U	20 U	20 U	30	21
4,4'-DDT	UG/KG	3700	33%	2100	1	59	178	26 J	22 J	26 J	52 J	29 J
Aldrin	UG/KG	1.2	1%	41	0	1	178	10 U	10 U	10 U	11 U	10 U

Table A-2A
SURFACE SOIL SAMPLE RESULTS (0-2 ft.)
SEAD-59
SEAD-59 and SEAD-71 Phase II RI Report
Seneca Army Depot Activity

Facility	SEAD-59	SEAD-59	SEAD-59	SEAD-59	SEAD-59
Location ID	WS-59-01-015-2	WS-59-01-015-5	WS-59-01-015-6	WS-59-01-015-7	WS-59-01-015-9
Matrix	SOIL	SOIL	SOIL	SOIL	SOIL
Sample ID	WS-59-01-015-2	WS-59-01-015-5	WS-59-01-015-6	WS-59-01-015-7	WS-59-01-015-9
Sample Depth to Top of Sample ⁽¹⁾	0	0	0	0	0
Sample Depth to Bottom of Sample ⁽¹⁾	0	0	0	0	0
Sample Date	5/6/2004	5/6/2004	5/6/2004	5/6/2004	5/6/2004
QC Code	SA	SA	SA	SA	SA
Study ID	ENSR IRM	ENSR IRM	ENSR IRM	ENSR IRM	ENSR IRM
Sample Round	1	1	1	1	1

Parameter	Units	Maximum Value	Frequency of Detection	NYSDEC TAGM 4046 ⁽²⁾	Number of Exceedances	Number of Detects	Number of Analyses ⁽³⁾	Value (Q)	Value (Q)	Value (Q)	Value (Q)	Value (Q)
Alpha-BHC	UG/KG	0	0%	110	0	0	178	10 U	10 U	10 U	11 U	10 U
Alpha-Chlordane	UG/KG	34	4%		0	7	178	10 U	10 U	10 U	11 U	10 U
Beta-BHC	UG/KG	2.4	1%	200	0	1	178	10 U	10 U	10 U	11 U	10 U
Delta-BHC	UG/KG	0	0%	300	0	0	178	10 U	10 U	10 U	11 U	10 U
Dieldrin	UG/KG	0	0%	44	0	0	178	20 U	20 U	20 U	20 U	20 U
Endosulfan I	UG/KG	16	1%	900	0	1	178	10 U	10 U	10 U	11 U	10 U
Endosulfan II	UG/KG	0	0%	900	0	0	178	20 U	20 U	20 U	20 U	20 U
Endosulfan sulfate	UG/KG	6.2	1%	1000	0	1	178	20 U	20 U	20 U	20 U	20 U
Endrin	UG/KG	16	2%	100	0	3	178	20 U	20 U	20 U	20 U	20 U
Endrin aldehyde	UG/KG	4.9	1%		0	2	178	20 U	20 U	20 U	20 U	20 U
Endrin ketone	UG/KG	38	2%		0	4	178	20 U	20 U	20 U	20 U	20 U
Gamma-BHC/Lindane	UG/KG	0	0%	60	0	0	178	10 U	10 U	10 U	11 U	10 U
Gamma-Chlordane	UG/KG	24	8%	540	0	14	178	10 U	10 U	10 U	11 U	10 U
Heptachlor	UG/KG	0	0%	100	0	0	178	10 U	10 U	10 U	11 U	10 U
Heptachlor epoxide	UG/KG	3	1%	20	0	2	178	10 U	10 U	10 U	11 U	10 U
Methoxychlor	UG/KG	0	0%		0	0	178	100 U	100 U	100 U	110 U	100 U
Toxaphene	UG/KG	0	0%		0	0	178	200 U	200 U	200 U	200 U	200 U
Aroclor-1016	UG/KG	0	0%		0	0	178	39 U	40 U	40 U	41 U	39 U
Aroclor-1221	UG/KG	0	0%		0	0	178	39 U	40 U	40 U	41 U	39 U
Aroclor-1232	UG/KG	0	0%		0	0	178	39 U	40 U	40 U	41 U	39 U
Aroclor-1242	UG/KG	0	0%		0	0	178	39 U	40 U	40 U	41 U	39 U
Aroclor-1248	UG/KG	0	0%		0	0	178	39 U	40 U	40 U	41 U	39 U
Aroclor-1254	UG/KG	0	0%	10000	0	0	178	39 U	40 U	40 U	41 U	39 U
Aroclor-1260	UG/KG	79	1%	10000	0	2	178	39 U	40 U	40 U	41 U	39 U
Metals												
Aluminum	MG/KG	18300	100%	19300	0	178	178	10400	11700	10800	10900	9880
Antimony	MG/KG	424	58%	5.9	5	104	178	3.5 UJ	3.6 UJ	3.6 UJ	3.6 UJ	3.4 UJ
Arsenic	MG/KG	32.2	100%	8.2	7	178	178	4.9	4.1	4.1	4.8	3.9
Barium	MG/KG	304	100%	300	1	178	178	95.4	111	102	112	89.4
Beryllium	MG/KG	2.6	99%	1.1	2	176	178	0.29	0.34	0.33	0.31	0.26
Cadmium	MG/KG	3.2	86%	2.3	2	153	178	0.39 J	0.7	0.67	0.81	0.62
Calcium	MG/KG	214000	100%	121000	1	178	178	54200	33200	26300	37100	41800
Chromium	MG/KG	39.3	100%	29.6	2	178	178	17.7	19.1	18	17	16.6
Cobalt	MG/KG	47.8	100%	30	2	178	178	8.2	9.8	9.8	10.2	9.1
Copper	MG/KG	305	100%	33	19	178	178	23.3	27.9	26.2	27.7	23.5
Cyanide	MG/KG	0	0%	0.35	0	0	9					
Iron	MG/KG	64000	100%	36500	1	178	178	20400	22500	19900	19400	20100
Lead	MG/KG	164	100%	24.8	75	178	178	21.4 J	28.8 J	30.5 J	33.7 J	23.7 J
Magnesium	MG/KG	30200	100%	21500	3	178	178	7720	6820	7200	6480	8540
Manganese	MG/KG	1290	100%	1060	3	178	178	529	590	539	577	463
Mercury	MG/KG	0.95	95%	0.1	37	169	178	0.05	0.07	0.07	0.07	0.09
Nickel	MG/KG	88.3	100%	49	3	178	178	22.8	29.3	27.4	27.1	26.2
Potassium	MG/KG	2290	100%	2380	0	178	178	1140	1280	1120	1300	1050
Selenium	MG/KG	1.5	9%	2	0	16	178	0.59 UJ	0.6 UJ	0.59 UJ	0.84 J	0.57 UJ
Silver	MG/KG	2.9	49%	0.75	62	87	178	0.59 UJ	0.6 UJ	0.59 UJ	0.61 UJ	0.57 UJ

**Table A-2A
SURFACE SOIL SAMPLE RESULTS (0-2 ft.)
SEAD-59
SEAD-59 and SEAD-71 Phase II RI Report
Seneca Army Depot Activity**

Facility	SEAD-59	SEAD-59	SEAD-59	SEAD-59	SEAD-59
Location ID	WS-59-01-015-2	WS-59-01-015-5	WS-59-01-015-6	WS-59-01-015-7	WS-59-01-015-9
Matrix	SOIL	SOIL	SOIL	SOIL	SOIL
Sample ID	WS-59-01-015-2	WS-59-01-015-5	WS-59-01-015-6	WS-59-01-015-7	WS-59-01-015-9
Sample Depth to Top of Sample ⁽¹⁾	0	0	0	0	0
Sample Depth to Bottom of Sample ⁽¹⁾	0	0	0	0	0
Sample Date	5/6/2004	5/6/2004	5/6/2004	5/6/2004	5/6/2004
QC Code	SA	SA	SA	SA	SA
Study ID	ENSR IRM	ENSR IRM	ENSR IRM	ENSR IRM	ENSR IRM
Sample Round	1	1	1	1	1

Parameter	Units	Maximum Value	Frequency of Detection	NYSDEC TAGM 4046 ⁽²⁾	Number of Exceedances	Number of Detects	Number of Analyses ⁽³⁾	Value (Q)	Value (Q)	Value (Q)	Value (Q)	Value (Q)
Sodium	MG/KG	4060	99%	172	86	177	178	243	294	267	343	222
Thallium	MG/KG	1.8	29%	0.7	24	51	178	0.59 U	0.73 J	0.59 U	0.65 J	0.62 J
Vanadium	MG/KG	28.5	100%	150	0	178	178	18.2	18.6	18.6	20.5	16.3
Zinc	MG/KG	341	100%	110	19	178	178	74.7 J	86.7 J	83.6 J	80.6 J	67.8 J

Note(s):

- (1) - Historical sample depths are presented (I.e. prior to 2002 TCRA)
- (2) - NYSDEC Technical and Administrative Guidance Memorandum (TAGM) HWR-94-4046, Revised January 24, 1994
- (3) - Sample/Duplicate pair are presented as individual samples in this table. Statistical information used Sample Duplicate pairs as a single entity and averaged result values were used in risk assessment analysis.

U = compound was not detected

J = the reported value is an estimated concentration

UJ = the compound was not detected; the associated reporting limit is approximate

R = the data was rejected in the data validating process

NJ = compound was "tentatively identified" and the associated numerical value is approximate

Table A-2A
SURFACE SOIL SAMPLE RESULTS (0-2 ft.)
SEAD-59
SEAD-59 and SEAD-71 Phase II RI Report
Seneca Army Depot Activity

Facility	SEAD-59	SEAD-59	SEAD-59	SEAD-59	SEAD-59
Location ID	WS-59-01-016-11	WS-59-01-016-12	WS-59-01-016-16	WS-59-01-016-17	WS-59-01-016-7
Matrix	SOIL	SOIL	SOIL	SOIL	SOIL
Sample ID	WS-59-01-016-11	WS-59-01-016-12	WS-59-01-016-16	WS-59-01-016-17	WS-59-01-016-7
Sample Depth to Top of Sample ⁽¹⁾	0	0	0	0	0
Sample Depth to Bottom of Sample ⁽¹⁾	0	0	0	0	0
Sample Date	5/6/2004	5/6/2004	5/6/2004	5/6/2004	5/6/2004
QC Code	SA	SA	SA	SA	SA
Study ID	ENSR IRM	ENSR IRM	ENSR IRM	ENSR IRM	ENSR IRM
Sample Round	1	1	1	1	1

Parameter	Units	Maximum Value	Frequency of Detection	NYSDEC TAGM 4046 ⁽²⁾	Number of Exceedances	Number of Detects	Number of Analyses ⁽³⁾	Value (Q)	Value (Q)	Value (Q)	Value (Q)	Value (Q)
Volatile Organics												
1,1,1-Trichloroethane	UG/KG	0	0%	800	0	0	177	5.7 U	5.9 U	5.9 U	5.8 U	6 U
1,1,2,2-Tetrachloroethane	UG/KG	0	0%	600	0	0	169	5.7 UJ	5.9 U	5.9 UJ	5.8 U	6 UJ
1,1,2-Trichloro-1,2,2-Trifluoroethane	UG/KG	0	0%		0	0	168	5.7 U	5.9 U	5.9 UJ	5.8 U	6 U
1,1,2-Trichloroethane	UG/KG	0	0%		0	0	107					
1,1-Dichloroethane	UG/KG	0	0%	200	0	0	177	5.7 U	5.9 U	5.9 U	5.8 U	6 U
1,1-Dichloroethene	UG/KG	8	2%	400	0	3	177	5.7 U	5.9 U	5.9 U	5.8 U	6 U
1,2,3-Trichloropropane	UG/KG	0	0%		0	0	70	5.7 UJ	5.9 U	5.9 U	5.8 U	6 UJ
1,2,4-Trichlorobenzene	UG/KG	0	0%	3400	0	0	161	5.7 UJ	5.9 U	5.9 U	5.8 U	6 UJ
1,2-Dibromo-3-chloropropane	UG/KG	0	0%		0	0	91					
1,2-Dibromoethane	UG/KG	0	0%		0	0	98					
1,2-Dichlorobenzene	UG/KG	0	0%	7900	0	0	161	5.7 UJ	5.9 U	5.9 U	5.8 U	6 UJ
1,2-Dichloroethane	UG/KG	0	0%	100	0	0	177	5.7 U	5.9 U	5.9 U	5.8 U	6 U
1,2-Dichloroethene (total)	UG/KG	0	0%		0	0	9					
1,2-Dichloropropane	UG/KG	0	0%		0	0	107					
1,3-Dichlorobenzene	UG/KG	0	0%	1600	0	0	161	5.7 UJ	5.9 U	5.9 U	5.8 U	6 UJ
1,3-Dichloropropane	UG/KG	0	0%		0	0	70	5.7 U	5.9 U	5.9 U	5.8 U	6 U
1,4-Dichlorobenzene	UG/KG	0	0%	8500	0	0	161	5.7 UJ	5.9 U	5.9 U	5.8 U	6 UJ
Acetone	UG/KG	550	27%	200	2	47	177	24	24 U	23 U	23 U	32
Benzene	UG/KG	3	4%	60	0	7	177	5.7 U	5.9 U	5.9 U	5.8 U	6 U
Bromodichloromethane	UG/KG	0	0%		0	0	107					
Bromoform	UG/KG	0	0%		0	0	107					
Carbon disulfide	UG/KG	4	3%	2700	0	6	177	5.7 U	5.9 U	5.9 U	5.8 U	6 U
Carbon tetrachloride	UG/KG	0	0%	600	0	0	177	5.7 U	5.9 U	5.9 U	5.8 U	6 U
Chlorobenzene	UG/KG	0	0%	1700	0	0	177	5.7 U	5.9 U	5.9 U	5.8 U	6 U
Chlorodibromomethane	UG/KG	0	0%		0	0	177	5.7 U	5.9 U	5.9 U	5.8 U	6 U
Chloroethane	UG/KG	0	0%	1900	0	0	177	11 U	12 U	12 U	12 U	12 U
Chloroform	UG/KG	0	0%	300	0	0	177	5.7 U	5.9 U	5.9 U	5.8 U	6 U
Cis-1,2-Dichloroethene	UG/KG	0	0%		0	0	98					
Cis-1,3-Dichloropropene	UG/KG	0	0%		0	0	107					
Cyclohexane	UG/KG	3	8%		0	8	98					
Dichlorodifluoromethane	UG/KG	0	0%		0	0	98					
Ethyl benzene	UG/KG	4.6	1%	5500	0	2	177	5.7 U	5.9 U	5.9 U	5.8 U	6 U
Isopropylbenzene	UG/KG	0	0%		0	0	98					
Meta/Para Xylene	UG/KG	9.4	4%		0	3	70	5.7 U	5.9 U	5.9 U	5.8 U	6 U
Methyl Acetate	UG/KG	2	3%		0	3	98					
Methyl Tertbutyl Ether	UG/KG	0	0%		0	0	98					
Methyl bromide	UG/KG	0	0%		0	0	107					
Methyl butyl ketone	UG/KG	0	0%		0	0	107					
Methyl chloride	UG/KG	0	0%		0	0	107					
Methyl cyclohexane	UG/KG	5	10%		0	10	98					
Methyl ethyl ketone	UG/KG	190	12%	300	0	22	177	11 U	12 U	12 U	12 U	3 J
Methyl isobutyl ketone	UG/KG	1.9	1%	1000	0	1	177	11 U	12 U	12 U	12 U	12 U
Methylene chloride	UG/KG	4.9	20%	100	0	36	178	5.7 U	5.9 U	5.9 U	5.8 U	6 U
Ortho Xylene	UG/KG	5.05	4%		0	3	70	5.7 U	5.9 U	5.9 U	5.8 U	6 U

Table A-2A
SURFACE SOIL SAMPLE RESULTS (0-2 ft.)
SEAD-59
SEAD-59 and SEAD-71 Phase II RI Report
Seneca Army Depot Activity

Facility	SEAD-59	SEAD-59	SEAD-59	SEAD-59	SEAD-59
Location ID	WS-59-01-016-11	WS-59-01-016-12	WS-59-01-016-16	WS-59-01-016-17	WS-59-01-016-7
Matrix	SOIL	SOIL	SOIL	SOIL	SOIL
Sample ID	WS-59-01-016-11	WS-59-01-016-12	WS-59-01-016-16	WS-59-01-016-17	WS-59-01-016-7
Sample Depth to Top of Sample ⁽¹⁾	0	0	0	0	0
Sample Depth to Bottom of Sample ⁽¹⁾	0	0	0	0	0
Sample Date	5/6/2004	5/6/2004	5/6/2004	5/6/2004	5/6/2004
QC Code	SA	SA	SA	SA	SA
Study ID	ENSR IRM	ENSR IRM	ENSR IRM	ENSR IRM	ENSR IRM
Sample Round	1	1	1	1	1

Parameter	Units	Maximum Value	Frequency of Detection	NYSDEC TAGM 4046 ⁽²⁾	Number of Exceedances	Number of Detects	Number of Analyses ⁽³⁾	Value (Q)	Value (Q)	Value (Q)	Value (Q)	Value (Q)
Styrene	UG/KG	0	0%		0	0	107					
Tetrachloroethene	UG/KG	6.4	3%	1400	0	5	177	5.7 U	5.9 U	5.9 U	5.1 J	6 U
Toluene	UG/KG	8	8%	1500	0	14	177	5.7 U	5.9 U	5.9 U	5.8 U	6 U
Total BTEX	MG/KG	3.25	67%		0	2	3					
Total Xylenes	UG/KG	3	7%	1200	0	7	102					
Trans-1,2-Dichloroethene	UG/KG	0	0%	300	0	0	168	5.7 U	5.9 U	5.9 U	5.8 U	6 U
Trans-1,3-Dichloropropene	UG/KG	0	0%		0	0	107					
Trichloroethene	UG/KG	4.5	5%	700	0	8	177	5.7 U	5.9 U	5.9 U	5.8 U	6 U
Trichlorofluoromethane	UG/KG	6	1%		0	1	98					
Vinyl chloride	UG/KG	0	0%	200	0	0	177	11 U	12 U	12 U	12 U	12 U
Semivolatile Organics												
1,1'-Biphenyl	UG/KG	254.5	2%		0	2	99					
1,2,4-Trichlorobenzene	UG/KG	0	0%	3400	0	0	9					
1,2-Dichlorobenzene	UG/KG	0	0%	7900	0	0	9					
1,3-Dichlorobenzene	UG/KG	0	0%	1600	0	0	9					
1,4-Dichlorobenzene	UG/KG	0	0%	8500	0	0	9					
2,2'-oxybis(1-Chloropropane)	UG/KG	0	0%		0	0	105					
2,4,5-Trichlorophenol	UG/KG	0	0%	100	0	0	178	1100 U	1200 U	1200 U	1100 U	2000 U
2,4,6-Trichlorophenol	UG/KG	0	0%		0	0	178	1100 U	1200 U	1200 U	1100 U	2000 U
2,4-Dichlorophenol	UG/KG	0	0%	400	0	0	178	1100 U	1200 U	1200 U	1100 U	2000 U
2,4-Dimethylphenol	UG/KG	0	0%		0	0	108					
2,4-Dinitrophenol	UG/KG	0	0%	200	0	0	178	5900 UJ	6100 UJ	6000 U	5900 U	10000 UJ
2,4-Dinitrotoluene	UG/KG	0	0%		0	0	178	1100 U	1200 U	1200 U	1100 U	2000 U
2,6-Dinitrotoluene	UG/KG	0	0%	1000	0	0	178	1100 U	1200 U	1200 U	1100 U	2000 U
2-Chloronaphthalene	UG/KG	0	0%		0	0	108					
2-Chlorophenol	UG/KG	0	0%	800	0	0	178	1100 U	1200 U	1200 U	1100 U	2000 U
2-Methylnaphthalene	UG/KG	1295	19%	36400	0	34	178	1100 U	1200 U	1200 U	1100 U	2000 U
2-Methylphenol	UG/KG	0	0%	100	0	0	178	1100 U	1200 U	1200 U	1100 U	2000 U
2-Nitroaniline	UG/KG	0	0%	430	0	0	178	5900 U	6100 U	6000 U	5900 U	10000 U
2-Nitrophenol	UG/KG	0	0%	330	0	0	178	1100 U	1200 U	1200 U	1100 U	2000 U
3,3'-Dichlorobenzidine	UG/KG	0	0%		0	0	178	1100 U	1200 U	1200 U	1100 U	2000 U
3-Nitroaniline	UG/KG	0	0%	500	0	0	178	5900 U	6100 U	6000 U	5900 U	10000 U
4,6-Dinitro-2-methylphenol	UG/KG	0	0%		0	0	108					
4-Bromophenyl phenyl ether	UG/KG	0	0%		0	0	108					
4-Chloro-3-methylphenol	UG/KG	0	0%	240	0	0	178	1100 U	1200 U	1200 U	1100 U	2000 U
4-Chloroaniline	UG/KG	1200	1%	220	1	2	178	1100 U	1200 U	1200 U	1100 U	2000 U
4-Chlorophenyl phenyl ether	UG/KG	0	0%		0	0	108					
4-Methylphenol	UG/KG	150	3%	900	0	5	178	1100 U	1200 U	1200 U	1100 U	2000 U
4-Nitroaniline	UG/KG	0	0%		0	0	108					
4-Nitrophenol	UG/KG	0	0%	100	0	0	178	5900 U	6100 U	6000 U	5900 U	10000 U
Acenaphthene	UG/KG	2680	24%	50000	0	42	178	1100 U	1200 U	120 J	290 J	2000 U
Acenaphthylene	UG/KG	1700	37%	41000	0	66	178	1100 U	130 J	160 J	1400	2000 U
Acetophenone	UG/KG	0	0%		0	0	99					
Aniline	UG/KG	0	0%		0	0	70	1100 U	1200 U	1200 U	1100 U	2000 U
Anthracene	UG/KG	4395	43%	50000	0	77	178	220 J	350 J	350 J	1100 J	2000 U

**Table A-2A
SURFACE SOIL SAMPLE RESULTS (0-2 ft.)
SEAD-59
SEAD-59 and SEAD-71 Phase II RI Report
Seneca Army Depot Activity**

Facility	SEAD-59	SEAD-59	SEAD-59	SEAD-59	SEAD-59							
Location ID	WS-59-01-016-11	WS-59-01-016-12	WS-59-01-016-16	WS-59-01-016-17	WS-59-01-016-7							
Matrix	SOIL	SOIL	SOIL	SOIL	SOIL							
Sample ID	WS-59-01-016-11	WS-59-01-016-12	WS-59-01-016-16	WS-59-01-016-17	WS-59-01-016-7							
Sample Depth to Top of Sample ⁽¹⁾	0	0	0	0	0							
Sample Depth to Bottom of Sample ⁽¹⁾	0	0	0	0	0							
Sample Date	5/6/2004	5/6/2004	5/6/2004	5/6/2004	5/6/2004							
QC Code	SA	SA	SA	SA	SA							
Study ID	ENSR IRM	ENSR IRM	ENSR IRM	ENSR IRM	ENSR IRM							
Sample Round	1	1	1	1	1							
Parameter	Units	Maximum Value	Frequency of Detection	NYSDEC TAGM 4046 ⁽²⁾	Number of Exceedances	Number of Detects	Number of Analyses ⁽³⁾	Value (Q)	Value (Q)	Value (Q)	Value (Q)	Value (Q)
Atrazine	UG/KG	120	1%		0	1	99					
Benzaldehyde	UG/KG	50	1%		0	1	99					
Benzo(a)anthracene	UG/KG	8900	51%	224	72	90	178	700 J	1100 J	1000 J	3100	390 J
Benzo(a)pyrene	UG/KG	8050	51%	61	84	91	178	670 J	940 J	1000 J	3600	390 J
Benzo(b)fluoranthene	UG/KG	6800	52%	1100	40	92	178	570 J	740 J	870 J	2600	380 J
Benzo(ghi)perylene	UG/KG	5200	46%	50000	0	82	178	500 J	580 J	680 J	2300	320 J
Benzo(k)fluoranthene	UG/KG	7350	49%	1100	35	88	178	630 J	840 J	900 J	2700	350 J
Benzoic Acid	UG/KG	0	0%	2700	0	0	70	5900 U	6100 U	6000 U	5900 U	10000 U
Bis(2-Chloroethoxy)methane	UG/KG	0	0%		0	0	108					
Bis(2-Chloroethyl)ether	UG/KG	0	0%		0	0	108					
Bis(2-Chloroisopropyl)ether	UG/KG	0	0%		0	0	3					
Bis(2-Ethylhexyl)phthalate	UG/KG	990	19%	50000	0	34	178	1100 U	1200 U	1200 U	1100 U	2000 U
Butylbenzylphthalate	UG/KG	0	0%	50000	0	0	178	1100 U	1200 U	1200 U	1100 U	2000 U
Caprolactam	UG/KG	0	0%		0	0	99					
Carbazole	UG/KG	755	19%		0	20	108					
Chrysene	UG/KG	8900	51%	400	62	91	178	710 J	1100 J	1200	3000	450 J
Di-n-butylphthalate	UG/KG	965	2%	8100	0	4	178	1100 U	1200 U	1200 U	1100 U	2000 U
Di-n-octylphthalate	UG/KG	0	0%	50000	0	0	178	1100 U	1200 U	1200 U	1100 U	2000 U
Dibenz(a,h)anthracene	UG/KG	1665	38%	14	67	68	178	160 J	190 J	210 J	740 J	2000 U
Dibenzofuran	UG/KG	2350	16%	6200	0	28	178	1100 U	1200 U	1200 U	160 J	2000 U
Diethyl phthalate	UG/KG	10	1%	7100	0	1	178	1100 U	1200 U	1200 U	1100 U	2000 U
Dimethylphthalate	UG/KG	0	0%	2000	0	0	178	1100 U	1200 U	1200 U	1100 U	2000 U
Fluoranthene	UG/KG	23500	54%	50000	0	97	178	1400	2600	2600	5500	730 J
Fluorene	UG/KG	2640	28%	50000	0	49	178	1100 U	1200 U	1200 U	300 J	2000 U
Hexachlorobenzene	UG/KG	0	0%	410	0	0	178	1100 U	1200 U	1200 U	1100 U	2000 U
Hexachlorobutadiene	UG/KG	0	0%		0	0	178	1100 U	1200 U	1200 U	1100 U	2000 U
Hexachlorocyclopentadiene	UG/KG	0	0%		0	0	108					
Hexachloroethane	UG/KG	0	0%		0	0	178	1100 U	1200 U	1200 U	1100 U	2000 U
Indeno(1,2,3-cd)pyrene	UG/KG	4950	47%	3200	2	84	178	450 J	580 J	640 J	2100 J	280 J
Isophorone	UG/KG	0	0%	4400	0	0	178	1100 U	1200 U	1200 U	1100 U	2000 U
N-Nitrosodiphenylamine	UG/KG	100	1%		0	1	108					
N-Nitrosodipropylamine	UG/KG	0	0%		0	0	108					
Naphthalene	UG/KG	1800	19%	13000	0	34	178	1100 U	1200 U	1200 U	150 J	2000 U
Nitrobenzene	UG/KG	0	0%	200	0	0	178	1100 U	1200 U	1200 U	1100 U	2000 U
Pentachlorophenol	UG/KG	0	0%	1000	0	0	178	5900 U	6100 U	6000 U	5900 U	10000 U
Phenanthrene	UG/KG	21300	51%	50000	0	90	178	810 J	1300	1400	2500	370 J
Phenol	UG/KG	0	0%	30	0	0	178	1100 U	1200 U	1200 U	1100 U	2000 U
Pyrene	UG/KG	19200	55%	50000	0	98	178	1100 J	1900	1800	4700	680 J
Pyridine	UG/KG	0	0%		0	0	100	5900 U	6100 U	6000 U	5900 U	10000 U
Total Unknown PAHs as SV	MG/KG	25	100%		0	3	3					
Pesticides/PCBs												
4,4'-DDD	UG/KG	740	28%	2900	0	49	178	95 U	98 U	97 U	95 U	99 U
4,4'-DDE	UG/KG	2600	37%	2100	1	65	178	95 U	98 U	97 U	95 U	99 U
4,4'-DDT	UG/KG	3700	33%	2100	1	59	178	95 U	98 U	97 U	95 U	99 U
Aldrin	UG/KG	1.2	1%	41	0	1	178	49 U	50 U	50 U	49 U	51 U

Table A-2A
SURFACE SOIL SAMPLE RESULTS (0-2 ft.)
SEAD-59
SEAD-59 and SEAD-71 Phase II RI Report
Seneca Army Depot Activity

Facility	SEAD-59	SEAD-59	SEAD-59	SEAD-59	SEAD-59							
Location ID	WS-59-01-016-11	WS-59-01-016-12	WS-59-01-016-16	WS-59-01-016-17	WS-59-01-016-7							
Matrix	SOIL	SOIL	SOIL	SOIL	SOIL							
Sample ID	WS-59-01-016-11	WS-59-01-016-12	WS-59-01-016-16	WS-59-01-016-17	WS-59-01-016-7							
Sample Depth to Top of Sample ⁽¹⁾	0	0	0	0	0							
Sample Depth to Bottom of Sample ⁽¹⁾	0	0	0	0	0							
Sample Date	5/6/2004	5/6/2004	5/6/2004	5/6/2004	5/6/2004							
QC Code	SA	SA	SA	SA	SA							
Study ID	ENSR IRM	ENSR IRM	ENSR IRM	ENSR IRM	ENSR IRM							
Sample Round	1	1	1	1	1							
Parameter	Units	Maximum Value	Frequency of Detection	NYSDEC TAGM 4046 ⁽²⁾	Number of Exceedances	Number of Detects	Number of Analyses ⁽³⁾	Value (Q)	Value (Q)	Value (Q)	Value (Q)	Value (Q)
Alpha-BHC	UG/KG	0	0%	110	0	0	178	49 U	50 U	50 U	49 U	51 U
Alpha-Chlordane	UG/KG	34	4%		0	7	178	49 U	50 U	50 U	49 U	51 U
Beta-BHC	UG/KG	2.4	1%	200	0	1	178	49 U	50 U	50 U	49 U	51 U
Delta-BHC	UG/KG	0	0%	300	0	0	178	49 U	50 U	50 U	49 U	51 U
Dieldrin	UG/KG	0	0%	44	0	0	178	95 U	98 U	97 U	95 U	99 U
Endosulfan I	UG/KG	16	1%	900	0	1	178	49 U	50 U	50 U	49 U	51 U
Endosulfan II	UG/KG	0	0%	900	0	0	178	95 U	98 U	97 U	95 U	99 U
Endosulfan sulfate	UG/KG	6.2	1%	1000	0	1	178	95 U	98 U	97 U	95 U	99 U
Endrin	UG/KG	16	2%	100	0	3	178	95 U	98 U	97 U	95 U	99 U
Endrin aldehyde	UG/KG	4.9	1%		0	2	178	95 U	98 U	97 U	95 U	99 U
Endrin ketone	UG/KG	38	2%		0	4	178	95 U	98 U	97 U	95 U	99 U
Gamma-BHC/Lindane	UG/KG	0	0%	60	0	0	178	49 U	50 U	50 U	49 U	51 U
Gamma-Chlordane	UG/KG	24	8%	540	0	14	178	49 U	50 U	50 U	49 U	51 U
Heptachlor	UG/KG	0	0%	100	0	0	178	49 U	50 U	50 U	49 U	51 U
Heptachlor epoxide	UG/KG	3	1%	20	0	2	178	49 U	50 U	50 U	49 U	51 U
Methoxychlor	UG/KG	0	0%		0	0	178	490 U	500 U	500 U	490 U	510 U
Toxaphene	UG/KG	0	0%		0	0	178	950 U	980 U	970 U	950 U	990 U
Aroclor-1016	UG/KG	0	0%		0	0	178	38 U	39 U	39 U	38 U	40 U
Aroclor-1221	UG/KG	0	0%		0	0	178	38 U	39 U	39 U	38 U	40 U
Aroclor-1232	UG/KG	0	0%		0	0	178	38 U	39 U	39 U	38 U	40 U
Aroclor-1242	UG/KG	0	0%		0	0	178	38 U	39 U	39 U	38 U	40 U
Aroclor-1248	UG/KG	0	0%		0	0	178	38 U	39 U	39 U	38 U	40 U
Aroclor-1254	UG/KG	0	0%	10000	0	0	178	38 U	39 U	39 U	38 U	40 U
Aroclor-1260	UG/KG	79	1%	10000	0	2	178	38 U	39 U	39 U	38 U	40 U
Metals												
Aluminum	MG/KG	18300	100%	19300	0	178	178	10500	11000	11200	10200	11700
Antimony	MG/KG	424	58%	5.9	5	104	178	3.2 UJ	3.3 UJ	3.5 UJ	3.3 UJ	3.5 UJ
Arsenic	MG/KG	32.2	100%	8.2	7	178	178	4.1	4.3	5.2	4.2	5.1
Barium	MG/KG	304	100%	300	1	178	178	80.2	98	89.5	74.2	105
Beryllium	MG/KG	2.6	99%	1.1	2	176	178	0.38	0.37	0.37	0.29	0.35
Cadmium	MG/KG	3.2	86%	2.3	2	153	178	0.66	0.65	0.74	0.6	1.5
Calcium	MG/KG	214000	100%	121000	1	178	178	43700	30700	40200	71100	53300
Chromium	MG/KG	39.3	100%	29.6	2	178	178	18.4	17.6	18.7	16.9	19.7
Cobalt	MG/KG	47.8	100%	30	2	178	178	10	9	11	8.6	10.9
Copper	MG/KG	305	100%	33	19	178	178	27.3 J	25 J	26.1 J	22.3 J	28.8 J
Cyanide	MG/KG	0	0%	0.35	0	0	9					
Iron	MG/KG	64000	100%	36500	1	178	178	20900	20700	22200	18000	22400
Lead	MG/KG	164	100%	24.8	75	178	178	33.5 J	27.5 J	32.3 J	43.3 J	43.3 J
Magnesium	MG/KG	30200	100%	21500	3	178	178	6570	10700	7520	9530	7860
Manganese	MG/KG	1290	100%	1060	3	178	178	455	524	600	569	626
Mercury	MG/KG	0.95	95%	0.1	37	169	178	0.07	0.07	0.06	0.07	0.1
Nickel	MG/KG	88.3	100%	49	3	178	178	31.5	26.6	30.4	49.5	32
Potassium	MG/KG	2290	100%	2380	0	178	178	1220	1210	1260	1080	1480
Selenium	MG/KG	1.5	9%	2	0	16	178	0.54 UJ	0.55 UJ	0.58 U	0.55 U	0.58 U
Silver	MG/KG	2.9	49%	0.75	62	87	178	0.54 U	0.55 U	0.58 U	0.85 J	0.58 U

**Table A-2A
SURFACE SOIL SAMPLE RESULTS (0-2 ft.)
SEAD-59
SEAD-59 and SEAD-71 Phase II RI Report
Seneca Army Depot Activity**

Facility	SEAD-59	SEAD-59	SEAD-59	SEAD-59	SEAD-59
Location ID	WS-59-01-016-11	WS-59-01-016-12	WS-59-01-016-16	WS-59-01-016-17	WS-59-01-016-7
Matrix	SOIL	SOIL	SOIL	SOIL	SOIL
Sample ID	WS-59-01-016-11	WS-59-01-016-12	WS-59-01-016-16	WS-59-01-016-17	WS-59-01-016-7
Sample Depth to Top of Sample ⁽¹⁾	0	0	0	0	0
Sample Depth to Bottom of Sample ⁽¹⁾	0	0	0	0	0
Sample Date	5/6/2004	5/6/2004	5/6/2004	5/6/2004	5/6/2004
QC Code	SA	SA	SA	SA	SA
Study ID	ENSR IRM	ENSR IRM	ENSR IRM	ENSR IRM	ENSR IRM
Sample Round	1	1	1	1	1

Parameter	Units	Maximum Value	Frequency of Detection	NYSDEC TAGM 4046 ⁽²⁾	Number of Exceedances	Number of Detects	Number of Analyses ⁽³⁾	Value (Q)	Value (Q)	Value (Q)	Value (Q)	Value (Q)
Sodium	MG/KG	4060	99%	172	86	177	178	435	644	546	125	819
Thallium	MG/KG	1.8	29%	0.7	24	51	178	0.65 J	0.6 J	0.58 U	0.55 U	0.63 J
Vanadium	MG/KG	28.5	100%	150	0	178	178	18.6	18.7	21	19.1	20.2
Zinc	MG/KG	341	100%	110	19	178	178	80.5 J	88.9 J	77 J	66.9 J	85.6 J

Note(s):

- (1) - Historical sample depths are presented (I.e. prior to 2002 TCRA)
- (2) - NYSDEC Technical and Administrative Guidance Memorandum (TAGM) HWR-94-4046, Revised January 24, 1994
- (3) - Sample/Duplicate pair are presented as individual samples in this table. Statistical information used Sample Duplicate pairs as a single entity and averaged result values were used in risk assessment analysis.

U = compound was not detected

J = the reported value is an estimated concentration

UJ = the compound was not detected; the associated reporting limit is approximate

R = the data was rejected in the data validating process

NJ = compound was "tentatively identified" and the associated numerical value is approximate

Table A-2A
SURFACE SOIL SAMPLE RESULTS (0-2 ft.)
SEAD-59
SEAD-59 and SEAD-71 Phase II RI Report
Seneca Army Depot Activity

Facility	SEAD-59	SEAD-59	SEAD-59	SEAD-59	SEAD-59
Location ID	WS-59-01-016-8	WS-59-01-017-1	WS-59-01-017-2	WS-59-01-018-1	WS-59-01-018-2
Matrix	SOIL	SOIL	SOIL	SOIL	SOIL
Sample ID	WS-59-01-016-8	WS-59-01-017-1	WS-59-01-017-2	WS-59-01-018-1	WS-59-01-018-2
Sample Depth to Top of Sample ⁽¹⁾	0	0	0	0	0
Sample Depth to Bottom of Sample ⁽¹⁾	0	0	0	0	0
Sample Date	5/6/2004	5/6/2004	5/6/2004	5/6/2004	5/6/2004
QC Code	SA	SA	SA	SA	SA
Study ID	ENSR IRM	ENSR IRM	ENSR IRM	ENSR IRM	ENSR IRM
Sample Round	1	1	1	1	1

Parameter	Units	Maximum Value	Frequency of Detection	NYSDEC TAGM 4046 ⁽²⁾	Number of Exceedances	Number of Detects	Number of Analyses ⁽³⁾	Value (Q)	Value (Q)	Value (Q)	Value (Q)	Value (Q)
Volatile Organics												
1,1,1-Trichloroethane	UG/KG	0	0%	800	0	0	177	5.9 U	5.8 U	5.8 U	5.8 U	5.9 U
1,1,2,2-Tetrachloroethane	UG/KG	0	0%	600	0	0	169	5.9 U	5.8 U	5.8 U	5.8 U	5.9 U
1,1,2-Trichloro-1,2,2-Trifluoroethane	UG/KG	0	0%		0	0	168	5.9 U	5.8 U	5.8 U	5.8 U	5.9 U
1,1,2-Trichloroethane	UG/KG	0	0%		0	0	107					
1,1-Dichloroethane	UG/KG	0	0%	200	0	0	177	5.9 U	5.8 U	5.8 U	5.8 U	5.9 U
1,1-Dichloroethene	UG/KG	8	2%	400	0	3	177	5.9 U	5.8 U	5.8 U	5.8 U	5.9 U
1,2,3-Trichloropropane	UG/KG	0	0%		0	0	70	5.9 U	5.8 U	5.8 U	5.8 U	5.9 U
1,2,4-Trichlorobenzene	UG/KG	0	0%	3400	0	0	161	5.9 U	5.8 U	5.8 U	5.8 U	5.9 U
1,2-Dibromo-3-chloropropane	UG/KG	0	0%		0	0	91					
1,2-Dibromoethane	UG/KG	0	0%		0	0	98					
1,2-Dichlorobenzene	UG/KG	0	0%	7900	0	0	161	5.9 U	5.8 U	5.8 U	5.8 U	5.9 U
1,2-Dichloroethane	UG/KG	0	0%	100	0	0	177	5.9 U	5.8 U	5.8 U	5.8 U	5.9 U
1,2-Dichloroethene (total)	UG/KG	0	0%		0	0	9					
1,2-Dichloropropane	UG/KG	0	0%		0	0	107					
1,3-Dichlorobenzene	UG/KG	0	0%	1600	0	0	161	5.9 U	5.8 U	5.8 U	5.8 U	5.9 U
1,3-Dichloropropane	UG/KG	0	0%		0	0	70	5.9 U	5.8 U	5.8 U	5.8 U	5.9 U
1,4-Dichlorobenzene	UG/KG	0	0%	8500	0	0	161	5.9 U	5.8 U	5.8 U	5.8 U	5.9 U
Acetone	UG/KG	550	27%	200	2	47	177	24 U	23 U	23 U	23 UJ	24 UJ
Benzene	UG/KG	3	4%	60	0	7	177	5.9 U	5.8 U	5.8 U	5.8 U	5.9 U
Bromodichloromethane	UG/KG	0	0%		0	0	107					
Bromoform	UG/KG	0	0%		0	0	107					
Carbon disulfide	UG/KG	4	3%	2700	0	6	177	5.9 U	5.8 U	5.8 U	5.8 U	5.9 U
Carbon tetrachloride	UG/KG	0	0%	600	0	0	177	5.9 U	5.8 U	5.8 U	5.8 U	5.9 U
Chlorobenzene	UG/KG	0	0%	1700	0	0	177	5.9 U	5.8 U	5.8 U	5.8 U	5.9 U
Chlorodibromomethane	UG/KG	0	0%		0	0	177	5.9 U	5.8 U	5.8 U	5.8 U	5.9 U
Chloroethane	UG/KG	0	0%	1900	0	0	177	12 U	12 U	12 U	12 U	12 U
Chloroform	UG/KG	0	0%	300	0	0	177	5.9 U	5.8 U	5.8 U	5.8 U	5.9 U
Cis-1,2-Dichloroethene	UG/KG	0	0%		0	0	98					
Cis-1,3-Dichloropropene	UG/KG	0	0%		0	0	107					
Cyclohexane	UG/KG	3	8%		0	8	98					
Dichlorodifluoromethane	UG/KG	0	0%		0	0	98					
Ethyl benzene	UG/KG	4.6	1%	5500	0	2	177	5.9 U	5.8 U	5.8 U	5.8 U	5.9 U
Isopropylbenzene	UG/KG	0	0%		0	0	98					
Meta/Para Xylene	UG/KG	9.4	4%		0	3	70	5.9 U	5.8 U	5.8 U	5.8 U	5.9 U
Methyl Acetate	UG/KG	2	3%		0	3	98					
Methyl Tertbutyl Ether	UG/KG	0	0%		0	0	98					
Methyl bromide	UG/KG	0	0%		0	0	107					
Methyl butyl ketone	UG/KG	0	0%		0	0	107					
Methyl chloride	UG/KG	0	0%		0	0	107					
Methyl cyclohexane	UG/KG	5	10%		0	10	98					
Methyl ethyl ketone	UG/KG	190	12%	300	0	22	177	12 U	12 U	12 U	12 U	2.3 J
Methyl isobutyl ketone	UG/KG	1.9	1%	1000	0	1	177	12 U	12 U	12 U	12 U	12 U
Methylene chloride	UG/KG	4.9	20%	100	0	36	178	5.9 U	5.8 U	5.8 U	4.9 J	3.9 J
Ortho Xylene	UG/KG	5.05	4%		0	3	70	5.9 U	5.8 U	5.8 U	5.8 U	5.9 U

**Table A-2A
SURFACE SOIL SAMPLE RESULTS (0-2 ft.)
SEAD-59
SEAD-59 and SEAD-71 Phase II RI Report
Seneca Army Depot Activity**

Facility	SEAD-59	SEAD-59	SEAD-59	SEAD-59	SEAD-59
Location ID	WS-59-01-016-8	WS-59-01-017-1	WS-59-01-017-2	WS-59-01-018-1	WS-59-01-018-2
Matrix	SOIL	SOIL	SOIL	SOIL	SOIL
Sample ID	WS-59-01-016-8	WS-59-01-017-1	WS-59-01-017-2	WS-59-01-018-1	WS-59-01-018-2
Sample Depth to Top of Sample ⁽¹⁾	0	0	0	0	0
Sample Depth to Bottom of Sample ⁽¹⁾	0	0	0	0	0
Sample Date	5/6/2004	5/6/2004	5/6/2004	5/6/2004	5/6/2004
QC Code	SA	SA	SA	SA	SA
Study ID	ENSR IRM	ENSR IRM	ENSR IRM	ENSR IRM	ENSR IRM
Sample Round	1	1	1	1	1

Parameter	Units	Maximum Value	Frequency of Detection	NYSDEC TAGM 4046 ⁽²⁾	Number of Exceedances	Number of Detects	Number of Analyses ⁽³⁾	Value (Q)	Value (Q)	Value (Q)	Value (Q)	Value (Q)
Styrene	UG/KG	0	0%		0	0	107					
Tetrachloroethene	UG/KG	6.4	3%	1400	0	5	177	5.9 U	6.4	5.8 J	5.8 U	5.9 U
Toluene	UG/KG	8	8%	1500	0	14	177	5.9 U	5.8 U	5.8 U	5.8 U	5.9 U
Total BTEX	MG/KG	3.25	67%		0	2	3					
Total Xylenes	UG/KG	3	7%	1200	0	7	102					
Trans-1,2-Dichloroethene	UG/KG	0	0%	300	0	0	168	5.9 U	5.8 U	5.8 U	5.8 U	5.9 U
Trans-1,3-Dichloropropene	UG/KG	0	0%		0	0	107					
Trichloroethene	UG/KG	4.5	5%	700	0	8	177	5.9 U	5.8 U	5.8 U	5.8 U	5.9 U
Trichlorofluoromethane	UG/KG	6	1%		0	1	98					
Vinyl chloride	UG/KG	0	0%	200	0	0	177	12 U	12 U	12 U	12 U	12 U
Semivolatile Organics												
1,1'-Biphenyl	UG/KG	254.5	2%		0	2	99					
1,2,4-Trichlorobenzene	UG/KG	0	0%	3400	0	0	9					
1,2-Dichlorobenzene	UG/KG	0	0%	7900	0	0	9					
1,3-Dichlorobenzene	UG/KG	0	0%	1600	0	0	9					
1,4-Dichlorobenzene	UG/KG	0	0%	8500	0	0	9					
2,2'-oxybis(1-Chloropropane)	UG/KG	0	0%		0	0	105					
2,4,5-Trichlorophenol	UG/KG	0	0%	100	0	0	178	1200 U	1900 U	1900 U	1100 U	1200 U
2,4,6-Trichlorophenol	UG/KG	0	0%		0	0	178	1200 U	1900 U	1900 U	1100 U	1200 U
2,4-Dichlorophenol	UG/KG	0	0%	400	0	0	178	1200 U	1900 U	1900 U	1100 U	1200 U
2,4-Dimethylphenol	UG/KG	0	0%		0	0	108					
2,4-Dinitrophenol	UG/KG	0	0%	200	0	0	178	6000 UJ	9900 U	9800 U	5900 U	6000 UJ
2,4-Dinitrotoluene	UG/KG	0	0%		0	0	178	1200 U	1900 U	1900 U	1100 U	1200 U
2,6-Dinitrotoluene	UG/KG	0	0%	1000	0	0	178	1200 U	1900 U	1900 U	1100 U	1200 U
2-Chloronaphthalene	UG/KG	0	0%		0	0	108					
2-Chlorophenol	UG/KG	0	0%	800	0	0	178	1200 U	1900 U	1900 U	1100 U	1200 U
2-Methylnaphthalene	UG/KG	1295	19%	36400	0	34	178	1200 U	1900 U	1900 U	190 J	290 J
2-Methylphenol	UG/KG	0	0%	100	0	0	178	1200 U	1900 U	1900 U	1100 U	1200 U
2-Nitroaniline	UG/KG	0	0%	430	0	0	178	6000 U	9900 U	9800 U	5900 U	6000 U
2-Nitrophenol	UG/KG	0	0%	330	0	0	178	1200 U	1900 U	1900 U	1100 U	1200 U
3,3'-Dichlorobenzidine	UG/KG	0	0%		0	0	178	1200 U	1900 U	1900 U	1100 U	1200 U
3-Nitroaniline	UG/KG	0	0%	500	0	0	178	6000 U	9900 U	9800 U	5900 U	6000 U
4,6-Dinitro-2-methylphenol	UG/KG	0	0%		0	0	108					
4-Bromophenyl phenyl ether	UG/KG	0	0%		0	0	108					
4-Chloro-3-methylphenol	UG/KG	0	0%	240	0	0	178	1200 U	1900 U	1900 U	1100 U	1200 U
4-Chloroaniline	UG/KG	1200	1%	220	1	2	178	1200 U	1900 U	1900 U	1100 U	1200 U
4-Chlorophenyl phenyl ether	UG/KG	0	0%		0	0	108					
4-Methylphenol	UG/KG	150	3%	900	0	5	178	1200 U	1900 U	1900 U	1100 U	1200 U
4-Nitroaniline	UG/KG	0	0%		0	0	108					
4-Nitrophenol	UG/KG	0	0%	100	0	0	178	6000 U	9900 U	9800 U	5900 U	6000 U
Acenaphthene	UG/KG	2680	24%	50000	0	42	178	1200 U	1900 U	1900 U	340 J	170 J
Acenaphthylene	UG/KG	1700	37%	41000	0	66	178	240 J	360 J	540 J	880 J	450 J
Acetophenone	UG/KG	0	0%		0	0	99					
Aniline	UG/KG	0	0%		0	0	70	1200 U	1900 U	1900 U	1100 U	1200 U
Anthracene	UG/KG	4395	43%	50000	0	77	178	240 J	440 J	630 J	970 J	570 J

**Table A-2A
SURFACE SOIL SAMPLE RESULTS (0-2 ft.)
SEAD-59
SEAD-59 and SEAD-71 Phase II RI Report
Seneca Army Depot Activity**

Facility	SEAD-59	SEAD-59	SEAD-59	SEAD-59	SEAD-59							
Location ID	WS-59-01-016-8	WS-59-01-017-1	WS-59-01-017-2	WS-59-01-018-1	WS-59-01-018-2							
Matrix	SOIL	SOIL	SOIL	SOIL	SOIL							
Sample ID	WS-59-01-016-8	WS-59-01-017-1	WS-59-01-017-2	WS-59-01-018-1	WS-59-01-018-2							
Sample Depth to Top of Sample ⁽¹⁾	0	0	0	0	0							
Sample Depth to Bottom of Sample ⁽¹⁾	0	0	0	0	0							
Sample Date	5/6/2004	5/6/2004	5/6/2004	5/6/2004	5/6/2004							
QC Code	SA	SA	SA	SA	SA							
Study ID	ENSR IRM	ENSR IRM	ENSR IRM	ENSR IRM	ENSR IRM							
Sample Round	1	1	1	1	1							
Parameter	Units	Maximum Value	Frequency of Detection	NYSDEC TAGM 4046 ⁽²⁾	Number of Exceedances	Number of Detects	Number of Analyses ⁽³⁾	Value (Q)	Value (Q)	Value (Q)	Value (Q)	Value (Q)
Atrazine	UG/KG	120	1%		0	1	99					
Benzaldehyde	UG/KG	50	1%		0	1	99					
Benzo(a)anthracene	UG/KG	8900	51%	224	72	90	178	810 J	1100 J	1900 J	2600	1400
Benzo(a)pyrene	UG/KG	8050	51%	61	84	91	178	910 J	1500 J	2100 J	2800	1500
Benzo(b)fluoranthene	UG/KG	6800	52%	1100	40	92	178	700 J	1300 J	1700 J	2100	1200
Benzo(ghi)perylene	UG/KG	5200	46%	50000	0	82	178	680 J	1000 J	1300 J	1600	1100 J
Benzo(k)fluoranthene	UG/KG	7350	49%	1100	35	88	178	760 J	1200 J	1800 J	2000	1200 J
Benzoic Acid	UG/KG	0	0%	2700	0	0	70	6000 U	9900 U	9800 U	5900 U	6000 U J
Bis(2-Chloroethoxy)methane	UG/KG	0	0%		0	0	108					
Bis(2-Chloroethyl)ether	UG/KG	0	0%		0	0	108					
Bis(2-Chloroisopropyl)ether	UG/KG	0	0%		0	0	3					
Bis(2-Ethylhexyl)phthalate	UG/KG	990	19%	50000	0	34	178	1200 U	1900 U	1900 U	1100 U	1200 U
Butylbenzylphthalate	UG/KG	0	0%	50000	0	0	178	1200 U	1900 U	1900 U	1100 U	1200 U
Caprolactam	UG/KG	0	0%		0	0	99					
Carbazole	UG/KG	755	19%		0	20	108					
Chrysene	UG/KG	8900	51%	400	62	91	178	900 J	1300 J	2100	2900	1600
Di-n-butylphthalate	UG/KG	965	2%	8100	0	4	178	1200 U	1900 U	1900 U	1100 U	1200 U
Di-n-octylphthalate	UG/KG	0	0%	50000	0	0	178	1200 U	1900 U	1900 U	1100 U	1200 U
Dibenz(a,h)anthracene	UG/KG	1665	38%	14	67	68	178	200 J	340 J	420 J	530 J	220 J
Dibenzofuran	UG/KG	2350	16%	6200	0	28	178	1200 U	1900 U	1900 U	130 NJ	1200 U
Diethyl phthalate	UG/KG	10	1%	7100	0	1	178	1200 U	1900 U	1900 U	1100 U	1200 U
Dimethylphthalate	UG/KG	0	0%	2000	0	0	178	1200 U	1900 U	1900 U	1100 U	1200 U
Fluoranthene	UG/KG	23500	54%	50000	0	97	178	1500	2400	4400	4900	3600
Fluorene	UG/KG	2640	28%	50000	0	49	178	1200 U	1900 U	1900 U	350 J	180 NJ
Hexachlorobenzene	UG/KG	0	0%	410	0	0	178	1200 U	1900 U	1900 U	1100 U	1200 U
Hexachlorobutadiene	UG/KG	0	0%		0	0	178	1200 U	1900 U	1900 U	1100 U	1200 U
Hexachlorocyclopentadiene	UG/KG	0	0%		0	0	108					
Hexachloroethane	UG/KG	0	0%		0	0	178	1200 U	1900 U	1900 U	1100 U	1200 U
Indeno(1,2,3-cd)pyrene	UG/KG	4950	47%	3200	2	84	178	590 J	950 J	1300 J	1500 J	970 J
Isophorone	UG/KG	0	0%	4400	0	0	178	1200 U	1900 U	1900 U	1100 U	1200 U
N-Nitrosodiphenylamine	UG/KG	100	1%		0	1	108					
N-Nitrosodipropylamine	UG/KG	0	0%		0	0	108					
Naphthalene	UG/KG	1800	19%	13000	0	34	178	1200 U	1900 U	1900 U	130 J	1200 U
Nitrobenzene	UG/KG	0	0%	200	0	0	178	1200 U	1900 U	1900 U	1100 U	1200 U
Pentachlorophenol	UG/KG	0	0%	1000	0	0	178	6000 U	9900 U	9800 U	5900 U	6000 U
Phenanthrene	UG/KG	21300	51%	50000	0	90	178	680 J	1400 J	2200	2000	1400
Phenol	UG/KG	0	0%	30	0	0	178	1200 U	1900 U	1900 U	1100 U	1200 U
Pyrene	UG/KG	19200	55%	50000	0	98	178	1400	1700 J	3000	4100	2500
Pyridine	UG/KG	0	0%		0	0	100	6000 U	9900 U	9800 U	5900 U	6000 U
Total Unknown PAHs as SV	MG/KG	25	100%		0	3	3					
Pesticides/PCBs												
4,4'-DDD	UG/KG	740	28%	2900	0	49	178	98 U	96 U	95 U	26	20 U
4,4'-DDE	UG/KG	2600	37%	2100	1	65	178	98 U	96 U	95 U	19 U	28
4,4'-DDT	UG/KG	3700	33%	2100	1	59	178	98 U	96 U	95 U	24 J	20 U
Aldrin	UG/KG	1.2	1%	41	0	1	178	50 U	50 U	49 U	9.9 U	10 U

**Table A-2A
SURFACE SOIL SAMPLE RESULTS (0-2 ft.)
SEAD-59
SEAD-59 and SEAD-71 Phase II RI Report
Seneca Army Depot Activity**

Facility	SEAD-59	SEAD-59	SEAD-59	SEAD-59	SEAD-59							
Location ID	WS-59-01-016-8	WS-59-01-017-1	WS-59-01-017-2	WS-59-01-018-1	WS-59-01-018-2							
Matrix	SOIL	SOIL	SOIL	SOIL	SOIL							
Sample ID	WS-59-01-016-8	WS-59-01-017-1	WS-59-01-017-2	WS-59-01-018-1	WS-59-01-018-2							
Sample Depth to Top of Sample ⁽¹⁾	0	0	0	0	0							
Sample Depth to Bottom of Sample ⁽¹⁾	0	0	0	0	0							
Sample Date	5/6/2004	5/6/2004	5/6/2004	5/6/2004	5/6/2004							
QC Code	SA	SA	SA	SA	SA							
Study ID	ENSR IRM	ENSR IRM	ENSR IRM	ENSR IRM	ENSR IRM							
Sample Round	1	1	1	1	1							
Parameter	Units	Maximum Value	Frequency of Detection	NYSDEC TAGM 4046 ⁽²⁾	Number of Exceedances	Number of Detects	Number of Analyses ⁽³⁾	Value (Q)	Value (Q)	Value (Q)	Value (Q)	Value (Q)
Alpha-BHC	UG/KG	0	0%	110	0	0	178	50 U	50 U	49 U	9.9 U	10 U
Alpha-Chlordane	UG/KG	34	4%		0	7	178	50 U	50 U	49 U	9.9 U	10 U
Beta-BHC	UG/KG	2.4	1%	200	0	1	178	50 U	50 U	49 U	9.9 U	10 U
Delta-BHC	UG/KG	0	0%	300	0	0	178	50 U	50 U	49 U	9.9 U	10 U
Dieldrin	UG/KG	0	0%	44	0	0	178	98 U	96 U	95 U	19 U	20 U
Endosulfan I	UG/KG	16	1%	900	0	1	178	50 U	50 U	49 U	9.9 U	10 U
Endosulfan II	UG/KG	0	0%	900	0	0	178	98 U	96 U	95 U	19 U	20 U
Endosulfan sulfate	UG/KG	6.2	1%	1000	0	1	178	98 U	96 U	95 U	19 U	20 U
Endrin	UG/KG	16	2%	100	0	3	178	98 U	96 U	95 U	19 U	20 U
Endrin aldehyde	UG/KG	4.9	1%		0	2	178	98 U	96 U	95 U	19 U	20 U
Endrin ketone	UG/KG	38	2%		0	4	178	98 U	96 U	95 U	19 U	20 U
Gamma-BHC/Lindane	UG/KG	0	0%	60	0	0	178	50 U	50 U	49 U	9.9 U	10 U
Gamma-Chlordane	UG/KG	24	8%	540	0	14	178	50 U	50 U	49 U	9.9 U	10 U
Heptachlor	UG/KG	0	0%	100	0	0	178	50 U	50 U	49 U	9.9 U	10 U
Heptachlor epoxide	UG/KG	3	1%	20	0	2	178	50 U	50 U	49 U	9.9 U	10 U
Methoxychlor	UG/KG	0	0%		0	0	178	500 U	500 U	490 U	99 U	100 U
Toxaphene	UG/KG	0	0%		0	0	178	980 U	960 U	950 U	190 U	200 U
Aroclor-1016	UG/KG	0	0%		0	0	178	39 U	38 U	38 U	38 U	39 U
Aroclor-1221	UG/KG	0	0%		0	0	178	39 U	38 U	38 U	38 U	39 U
Aroclor-1232	UG/KG	0	0%		0	0	178	39 U	38 U	38 U	38 U	39 U
Aroclor-1242	UG/KG	0	0%		0	0	178	39 U	38 U	38 U	38 U	39 U
Aroclor-1248	UG/KG	0	0%		0	0	178	39 U	38 U	38 U	38 U	39 U
Aroclor-1254	UG/KG	0	0%	10000	0	0	178	39 U	38 U	38 U	38 U	39 U
Aroclor-1260	UG/KG	79	1%	10000	0	2	178	39 U	38 U	38 U	38 U	39 U
Metals												
Aluminum	MG/KG	18300	100%	19300	0	178	178	11700	10800	10100	11900	12600
Antimony	MG/KG	424	58%	5.9	5	104	178	3.5 UJ	3.5 UJ	3.4 UJ	3.4 UJ	3.5 UJ
Arsenic	MG/KG	32.2	100%	8.2	7	178	178	5.4	4.1	4.8	5.1 J	4.7 J
Barium	MG/KG	304	100%	300	1	178	178	101	78.9	70.2	91.6	90.7
Beryllium	MG/KG	2.6	99%	1.1	2	176	178	0.41	0.3	0.27	0.3	0.3
Cadmium	MG/KG	3.2	86%	2.3	2	153	178	0.8	0.61	0.7	0.83	0.82
Calcium	MG/KG	214000	100%	121000	1	178	178	46800	40800	65700	39300 J	32100 J
Chromium	MG/KG	39.3	100%	29.6	2	178	178	20.3	18.2	20.6	19.9	20.2
Cobalt	MG/KG	47.8	100%	30	2	178	178	11.2	9.2	9.2	10.4	9.7
Copper	MG/KG	305	100%	33	19	178	178	29.6 J	26.4 J	29 J	31.7	30.1
Cyanide	MG/KG	0	0%	0.35	0	0	9					
Iron	MG/KG	64000	100%	36500	1	178	178	23300	19600	19800	22800	23500
Lead	MG/KG	164	100%	24.8	75	178	178	43.2 J	37.3 J	63.4 J	56.2	40.6
Magnesium	MG/KG	30200	100%	21500	3	178	178	7850	7680	9030	7970	7550
Manganese	MG/KG	1290	100%	1060	3	178	178	824	420	422	532	533
Mercury	MG/KG	0.95	95%	0.1	37	169	178	0.08	0.08	0.21	0.09	0.07
Nickel	MG/KG	88.3	100%	49	3	178	178	30.2	26.3	24.9	27.6	28.5
Potassium	MG/KG	2290	100%	2380	0	178	178	1360	1110	1210	1180	1220
Selenium	MG/KG	1.5	9%	2	0	16	178	0.59 U	0.58 U	0.57 U	0.57 U	0.59 U
Silver	MG/KG	2.9	49%	0.75	62	87	178	0.59 U	0.58 U	0.57 U	0.57 U	0.59 U

**Table A-2A
SURFACE SOIL SAMPLE RESULTS (0-2 ft.)
SEAD-59
SEAD-59 and SEAD-71 Phase II RI Report
Seneca Army Depot Activity**

Facility	SEAD-59	SEAD-59	SEAD-59	SEAD-59	SEAD-59
Location ID	WS-59-01-016-8	WS-59-01-017-1	WS-59-01-017-2	WS-59-01-018-1	WS-59-01-018-2
Matrix	SOIL	SOIL	SOIL	SOIL	SOIL
Sample ID	WS-59-01-016-8	WS-59-01-017-1	WS-59-01-017-2	WS-59-01-018-1	WS-59-01-018-2
Sample Depth to Top of Sample ⁽¹⁾	0	0	0	0	0
Sample Depth to Bottom of Sample ⁽¹⁾	0	0	0	0	0
Sample Date	5/6/2004	5/6/2004	5/6/2004	5/6/2004	5/6/2004
QC Code	SA	SA	SA	SA	SA
Study ID	ENSR IRM	ENSR IRM	ENSR IRM	ENSR IRM	ENSR IRM
Sample Round	1	1	1	1	1

Parameter	Units	Maximum Value	Frequency of Detection	NYSDEC TAGM 4046 ⁽²⁾	Number of Exceedances	Number of Detects	Number of Analyses ⁽³⁾	Value (Q)	Value (Q)	Value (Q)	Value (Q)	Value (Q)
								548	198	165	270	860
Sodium	MG/KG	4060	99%	172	86	177	178	548	198	165	270	860
Thallium	MG/KG	1.8	29%	0.7	24	51	178	0.6 J	0.58 U	0.57 U	0.57 U	0.59 U
Vanadium	MG/KG	28.5	100%	150	0	178	178	21.1	20.9	19.5	22.1	20.3
Zinc	MG/KG	341	100%	110	19	178	178	91.7 J	72.4 J	82.6 J	105 J	79.3 J

Note(s):

- (1) - Historical sample depths are presented (I.e. prior to 2002 TCRA)
- (2) - NYSDEC Technical and Administrative Guidance Memorandum (TAGM) HWR-94-4046, Revised January 24, 1994
- (3) - Sample/Duplicate pair are presented as individual samples in this table. Statistical information used Sample Duplicate pairs as a single entity and averaged result values were used in risk assessment analysis.

U = compound was not detected
 J = the reported value is an estimated concentration
 UJ = the compound was not detected; the associated reporting limit is approximate
 R = the data was rejected in the data validating process
 NJ = compound was "tentatively identified" and the associated numerical value is approximate

Table A-2A
SURFACE SOIL SAMPLE RESULTS (0-2 ft.)
SEAD-59
SEAD-59 and SEAD-71 Phase II RI Report
Seneca Army Depot Activity

Facility	SEAD-59	SEAD-59	SEAD-59	SEAD-59	SEAD-59
Location ID	WS-59-01-018-3	WS-59-01-018-4	WS-59-01-018-5	WS-59-01-018-6	WS-59-01-018-7
Matrix	SOIL	SOIL	SOIL	SOIL	SOIL
Sample ID	WS-59-01-018-3	WS-59-01-018-4	WS-59-01-018-5	WS-59-01-018-6	WS-59-01-018-7
Sample Depth to Top of Sample ⁽¹⁾	0	0	0	0	0
Sample Depth to Bottom of Sample ⁽¹⁾	0	0	0	0	0
Sample Date	5/6/2004	5/6/2004	5/6/2004	5/6/2004	5/6/2004
QC Code	SA	SA	SA	SA	SA
Study ID	ENSR IRM	ENSR IRM	ENSR IRM	ENSR IRM	ENSR IRM
Sample Round	1	1	1	1	1

Parameter	Units	Maximum Value	Frequency of Detection	NYSDEC TAGM 4046 ⁽²⁾	Number of Exceedances	Number of Detects	Number of Analyses ⁽³⁾	Value (Q)	Value (Q)	Value (Q)	Value (Q)	Value (Q)
Volatile Organics												
1,1,1-Trichloroethane	UG/KG	0	0%	800	0	0	177	5.9 U	5.9 U	5.6 U	5.7 U	6 U
1,1,2,2-Tetrachloroethane	UG/KG	0	0%	600	0	0	169	5.9 U	5.9 U	5.6 U	5.7 U	6 UJ
1,1,2-Trichloro-1,2,2-Trifluoroethane	UG/KG	0	0%		0	0	168	5.9 U	5.9 U	5.6 U	5.7 U	6 U
1,1,2-Trichloroethane	UG/KG	0	0%		0	0	107					6 U
1,1-Dichloroethane	UG/KG	0	0%	200	0	0	177	5.9 U	5.9 U	5.6 U	5.7 U	6 U
1,1-Dichloroethene	UG/KG	8	2%	400	0	3	177	5.9 U	5.9 U	5.6 U	5.7 U	6 U
1,2,3-Trichloropropane	UG/KG	0	0%		0	0	70	5.9 U	5.9 U	5.6 U	5.7 U	
1,2,4-Trichlorobenzene	UG/KG	0	0%	3400	0	0	161	5.9 U	5.9 U	5.6 U	5.7 U	6 UJ
1,2-Dibromo-3-chloropropane	UG/KG	0	0%		0	0	91					6 UJ
1,2-Dibromoethane	UG/KG	0	0%		0	0	98					6 U
1,2-Dichlorobenzene	UG/KG	0	0%	7900	0	0	161	5.9 U	5.9 U	5.6 U	5.7 U	6 UJ
1,2-Dichloroethane	UG/KG	0	0%	100	0	0	177	5.9 U	5.9 U	5.6 U	5.7 U	6 U
1,2-Dichloroethene (total)	UG/KG	0	0%		0	0	9					
1,2-Dichloropropane	UG/KG	0	0%		0	0	107					6 U
1,3-Dichlorobenzene	UG/KG	0	0%	1600	0	0	161	5.9 U	5.9 U	5.6 U	5.7 U	6 UJ
1,3-Dichloropropane	UG/KG	0	0%		0	0	70	5.9 U	5.9 U	5.6 U	5.7 U	
1,4-Dichlorobenzene	UG/KG	0	0%	8500	0	0	161	5.9 U	5.9 U	5.6 U	5.7 U	6 UJ
Acetone	UG/KG	550	27%	200	2	47	177	24 UJ	24 UJ	23 UJ	23 UJ	6 UJ
Benzene	UG/KG	3	4%	60	0	7	177	5.9 U	5.9 U	5.6 U	5.7 U	6 U
Bromodichloromethane	UG/KG	0	0%		0	0	107					6 U
Bromoform	UG/KG	0	0%		0	0	107					6 U
Carbon disulfide	UG/KG	4	3%	2700	0	6	177	5.9 U	5.9 U	5.6 U	5.7 U	6 U
Carbon tetrachloride	UG/KG	0	0%	600	0	0	177	5.9 U	5.9 U	5.6 U	5.7 U	6 U
Chlorobenzene	UG/KG	0	0%	1700	0	0	177	5.9 U	5.9 U	5.6 U	5.7 U	6 U
Chlorodibromomethane	UG/KG	0	0%		0	0	177	5.9 U	5.9 U	5.6 U	5.7 U	6 U
Chloroethane	UG/KG	0	0%	1900	0	0	177	12 U	12 U	11 U	11 U	6 U
Chloroform	UG/KG	0	0%	300	0	0	177	5.9 U	5.9 U	5.6 U	5.7 U	6 U
Cis-1,2-Dichloroethene	UG/KG	0	0%		0	0	98					6 U
Cis-1,3-Dichloropropene	UG/KG	0	0%		0	0	107					6 U
Cyclohexane	UG/KG	3	8%		0	8	98					6 U
Dichlorodifluoromethane	UG/KG	0	0%		0	0	98					6 U
Ethyl benzene	UG/KG	4.6	1%	5500	0	2	177	5.9 U	5.9 U	5.6 U	5.7 U	6 U
Isopropylbenzene	UG/KG	0	0%		0	0	98					6 U
Meta/Para Xylene	UG/KG	9.4	4%		0	3	70	5.9 U	5.9 U	5.6 U	5.7 U	
Methyl Acetate	UG/KG	2	3%		0	3	98					6 U
Methyl Tertbutyl Ether	UG/KG	0	0%		0	0	98					6 UJ
Methyl bromide	UG/KG	0	0%		0	0	107					6 UJ
Methyl butyl ketone	UG/KG	0	0%		0	0	107					6 UJ
Methyl chloride	UG/KG	0	0%		0	0	107					6 U
Methyl cyclohexane	UG/KG	5	10%		0	10	98					6 U
Methyl ethyl ketone	UG/KG	190	12%	300	0	22	177	12 U	12 U	11 U	11 U	6 U
Methyl isobutyl ketone	UG/KG	1.9	1%	1000	0	1	177	12 U	12 U	11 U	11 U	6 UJ
Methylene chloride	UG/KG	4.9	20%	100	0	36	178	4 J	3.8 J	3.6 J	5.7 U	6 UJ
Ortho Xylene	UG/KG	5.05	4%		0	3	70	5.9 U	5.9 U	5.6 U	5.7 U	

Table A-2A
SURFACE SOIL SAMPLE RESULTS (0-2 ft.)
SEAD-59
SEAD-59 and SEAD-71 Phase II RI Report
Seneca Army Depot Activity

Facility	SEAD-59	SEAD-59	SEAD-59	SEAD-59	SEAD-59
Location ID	WS-59-01-018-3	WS-59-01-018-4	WS-59-01-018-5	WS-59-01-018-6	WS-59-01-018-7
Matrix	SOIL	SOIL	SOIL	SOIL	SOIL
Sample ID	WS-59-01-018-3	WS-59-01-018-4	WS-59-01-018-5	WS-59-01-018-6	WS-59-01-018-7
Sample Depth to Top of Sample ⁽¹⁾	0	0	0	0	0
Sample Depth to Bottom of Sample ⁽¹⁾	0	0	0	0	0
Sample Date	5/6/2004	5/6/2004	5/6/2004	5/6/2004	5/6/2004
QC Code	SA	SA	SA	SA	SA
Study ID	ENSR IRM	ENSR IRM	ENSR IRM	ENSR IRM	ENSR IRM
Sample Round	1	1	1	1	1

Parameter	Units	Maximum Value	Frequency of Detection	NYSDEC TAGM 4046 ⁽²⁾	Number of Exceedances	Number of Detects	Number of Analyses ⁽³⁾	Value (Q)	Value (Q)	Value (Q)	Value (Q)	Value (Q)
Styrene	UG/KG	0	0%		0	0	107					6 U
Tetrachloroethene	UG/KG	6.4	3%	1400	0	5	177	5.9 U	5.9 U	5.6 U	5.7 U	6 U
Toluene	UG/KG	8	8%	1500	0	14	177	5.9 U	5.9 U	5.6 U	5.7 U	6 U
Total BTEX	MG/KG	3.25	67%		0	2	3					
Total Xylenes	UG/KG	3	7%	1200	0	7	102					6 UJ
Trans-1,2-Dichloroethene	UG/KG	0	0%	300	0	0	168	5.9 U	5.9 U	5.6 U	5.7 U	6 U
Trans-1,3-Dichloropropene	UG/KG	0	0%		0	0	107					6 U
Trichloroethene	UG/KG	4.5	5%	700	0	8	177	5.9 U	5.9 U	5.6 U	5.7 U	6 U
Trichlorofluoromethane	UG/KG	6	1%		0	1	98					6 U
Vinyl chloride	UG/KG	0	0%	200	0	0	177	12 U	12 U	11 U	11 U	6 U
Semivolatile Organics												
1,1'-Biphenyl	UG/KG	254.5	2%		0	2	99					380 U
1,2,4-Trichlorobenzene	UG/KG	0	0%	3400	0	0	9					
1,2-Dichlorobenzene	UG/KG	0	0%	7900	0	0	9					
1,3-Dichlorobenzene	UG/KG	0	0%	1600	0	0	9					
1,4-Dichlorobenzene	UG/KG	0	0%	8500	0	0	9					
2,2'-oxybis(1-Chloropropane)	UG/KG	0	0%		0	0	105					380 U
2,4,5-Trichlorophenol	UG/KG	0	0%	100	0	0	178	1200 U	1200 U	1100 U	1900 U	950 U
2,4,6-Trichlorophenol	UG/KG	0	0%		0	0	178	1200 U	1200 U	1100 U	1900 U	380 U
2,4-Dichlorophenol	UG/KG	0	0%	400	0	0	178	1200 U	1200 U	1100 U	1900 U	380 U
2,4-Dimethylphenol	UG/KG	0	0%		0	0	108					380 U
2,4-Dinitrophenol	UG/KG	0	0%	200	0	0	178	6000 U	6000 UJ	5700 UJ	9700 UJ	950 U
2,4-Dinitrotoluene	UG/KG	0	0%		0	0	178	1200 U	1100 U	1100 U	1900 U	380 U
2,6-Dinitrotoluene	UG/KG	0	0%	1000	0	0	178	1200 U	1200 U	1100 U	1900 U	380 U
2-Chloronaphthalene	UG/KG	0	0%		0	0	108					380 U
2-Chlorophenol	UG/KG	0	0%	800	0	0	178	1200 U	1200 U	1100 U	1900 U	380 U
2-Methylnaphthalene	UG/KG	1295	19%	36400	0	34	178	160 J	410 J	1100 U	200 J	100 J
2-Methylphenol	UG/KG	0	0%	100	0	0	178	1200 U	1200 U	1100 U	1900 U	380 U
2-Nitroaniline	UG/KG	0	0%	430	0	0	178	6000 U	6000 U	5700 U	9700 U	950 U
2-Nitrophenol	UG/KG	0	0%	330	0	0	178	1200 U	1200 U	1100 U	1900 U	380 U
3,3'-Dichlorobenzidine	UG/KG	0	0%		0	0	178	1200 U	1200 U	1100 U	1900 U	380 U
3-Nitroaniline	UG/KG	0	0%	500	0	0	178	6000 U	6000 U	5700 U	9700 U	950 U
4,6-Dinitro-2-methylphenol	UG/KG	0	0%		0	0	108					950 U
4-Bromophenyl phenyl ether	UG/KG	0	0%		0	0	108					380 U
4-Chloro-3-methylphenol	UG/KG	0	0%	240	0	0	178	1200 U	1200 U	1100 U	1900 U	380 U
4-Chloroaniline	UG/KG	1200	1%	220	1	2	178	1200 U	1200 U	1100 U	1900 U	380 U
4-Chlorophenyl phenyl ether	UG/KG	0	0%		0	0	108					380 U
4-Methylphenol	UG/KG	150	3%	900	0	5	178	1200 U	130 J	1100 U	1900 U	380 U
4-Nitroaniline	UG/KG	0	0%		0	0	108					950 U
4-Nitrophenol	UG/KG	0	0%	100	0	0	178	6000 U	6000 U	5700 U	9700 U	950 U
Acenaphthene	UG/KG	2680	24%	50000	0	42	178	1200 U	1100 U	1100 U	200 J	89 J
Acenaphthylene	UG/KG	1700	37%	41000	0	66	178	200 J	1200 U	190 J	340 J	86 J
Acetophenone	UG/KG	0	0%		0	0	99					380 U
Aniline	UG/KG	0	0%		0	0	70	1200 U	1200 U	1100 U	1900 U	
Anthracene	UG/KG	4395	43%	50000	0	77	178	170 J	200 J	210 J	520 J	160 J

**Table A-2A
SURFACE SOIL SAMPLE RESULTS (0-2 ft.)
SEAD-59
SEAD-59 and SEAD-71 Phase II RI Report
Seneca Army Depot Activity**

Facility	SEAD-59	SEAD-59	SEAD-59	SEAD-59	SEAD-59
Location ID	WS-59-01-018-3	WS-59-01-018-4	WS-59-01-018-5	WS-59-01-018-6	WS-59-01-018-7
Matrix	SOIL	SOIL	SOIL	SOIL	SOIL
Sample ID	WS-59-01-018-3	WS-59-01-018-4	WS-59-01-018-5	WS-59-01-018-6	WS-59-01-018-7
Sample Depth to Top of Sample ⁽¹⁾	0	0	0	0	0
Sample Depth to Bottom of Sample ⁽¹⁾	0	0	0	0	0
Sample Date	5/6/2004	5/6/2004	5/6/2004	5/6/2004	5/6/2004
QC Code	SA	SA	SA	SA	SA
Study ID	ENSR IRM	ENSR IRM	ENSR IRM	ENSR IRM	ENSR IRM
Sample Round	1	1	1	1	1

Parameter	Units	Maximum Value	Frequency of Detection	NYSDEC TAGM 4046 ⁽²⁾	Number of Exceedances	Number of Detects	Number of Analyses ⁽³⁾	Value (Q)	Value (Q)	Value (Q)	Value (Q)	Value (Q)
Atrazine	UG/KG	120	1%		0	1	99					380 U
Benzaldehyde	UG/KG	50	1%		0	1	99					380 U
Benzo(a)anthracene	UG/KG	8900	51%	224	72	90	178	420 J	340 J	620 J	1400 J	480 J
Benzo(a)pyrene	UG/KG	8050	51%	61	84	91	178	470 J	290 J	660 J	1400 J	500
Benzo(b)fluoranthene	UG/KG	6800	52%	1100	40	92	178	410 J	270 J	500 J	1200 J	670
Benzo(ghi)perylene	UG/KG	5200	46%	50000	0	82	178	320 J	210 J	480 J	920 J	280 J
Benzo(k)fluoranthene	UG/KG	7350	49%	1100	35	88	178	430 J	290 J	530 J	1100 J	260 J
Benzoic Acid	UG/KG	0	0%	2700	0	0	70	6000 U	6000 UJ	5700 UJ	9700 UJ	
Bis(2-Chloroethoxy)methane	UG/KG	0	0%		0	0	108					380 U
Bis(2-Chloroethyl)ether	UG/KG	0	0%		0	0	108					380 U
Bis(2-Chloroisopropyl)ether	UG/KG	0	0%		0	0	3					
Bis(2-Ethylhexyl)phthalate	UG/KG	990	19%	50000	0	34	178	1200 U	1200 U	1100 U	220 J	100 J
Butylbenzylphthalate	UG/KG	0	0%	50000	0	0	178	1200 U	1200 U	1100 U	1900 U	380 U
Caprolactam	UG/KG	0	0%		0	0	99					380 U
Carbazole	UG/KG	755	19%		0	20	108					120 J
Chrysene	UG/KG	8900	51%	400	62	91	178	480 J	360 J	730 J	1700 J	570
Di-n-butylphthalate	UG/KG	965	2%	8100	0	4	178	1200 U	1200 U	1100 U	1900 U	380 U
Di-n-octylphthalate	UG/KG	0	0%	50000	0	0	178	1200 U	1200 U	1100 U	1900 U	380 U
Dibenz(a,h)anthracene	UG/KG	1665	38%	14	67	68	178	1200 U	1200 U	150 J	270 J	74 J
Dibenzofuran	UG/KG	2350	16%	6200	0	28	178	1200 U	180 NJ	1100 U	1900 U	59 J
Diethyl phthalate	UG/KG	10	1%	7100	0	1	178	1200 U	1200 U	1100 U	1900 U	380 U
Dimethylphthalate	UG/KG	0	0%	2000	0	0	178	1200 U	1200 U	1100 U	1900 U	380 U
Fluoranthene	UG/KG	23500	54%	50000	0	97	178	850 J	930 J	1500 J	3500	1000
Fluorene	UG/KG	2640	28%	50000	0	49	178	150 NJ	310 NJ	120 NJ	290 J	87 J
Hexachlorobenzene	UG/KG	0	0%	410	0	0	178	1200 U	1200 U	1100 U	1900 U	380 U
Hexachlorobutadiene	UG/KG	0	0%		0	0	178	1200 U	1200 U	1100 U	1900 U	380 U
Hexachlorocyclopentadiene	UG/KG	0	0%		0	0	108					380 U
Hexachloroethane	UG/KG	0	0%		0	0	178	1200 U	1200 U	1100 U	1900 U	380 U
Indeno(1,2,3-cd)pyrene	UG/KG	4950	47%	3200	2	84	178	310 J	190 J	400 J	820 J	320 J
Isophorone	UG/KG	0	0%	4400	0	0	178	1200 U	1200 U	1100 U	1900 U	380 U
N-Nitrosodiphenylamine	UG/KG	100	1%		0	1	108					380 U
N-Nitrosodipropylamine	UG/KG	0	0%		0	0	108					380 U
Naphthalene	UG/KG	1800	19%	13000	0	34	178	150 J	1000 J	1100 U	290 J	380 U
Nitrobenzene	UG/KG	0	0%	200	0	0	178	1200 U	1200 U	1100 U	1900 U	380 U
Pentachlorophenol	UG/KG	0	0%	1000	0	0	178	6000 U	6000 U	5700 U	9700 U	950 U
Phenanthrene	UG/KG	21300	51%	50000	0	90	178	510 J	940 J	840 J	2400	630
Phenol	UG/KG	0	0%	30	0	0	178	1200 U	1200 U	1100 U	1900 U	380 U
Pyrene	UG/KG	19200	55%	50000	0	98	178	610 J	560 J	1000 J	2500	920
Pyridine	UG/KG	0	0%		0	0	100	6000 U	6000 U	5700 U	9700 U	380 U
Total Unknown PAHs as SV	MG/KG	25	100%		0	3	3					
Pesticides/PCBs												
4,4'-DDD	UG/KG	740	28%	2900	0	49	178	34	73	19 U	38	35
4,4'-DDE	UG/KG	2600	37%	2100	1	65	178	22	55 J	19 U	48 J	55 NJ
4,4'-DDT	UG/KG	3700	33%	2100	1	59	178	19 U	24	19	19 U	17
Aldrin	UG/KG	1.2	1%	41	0	1	178	10 U	10 U	9.6 U	9.7 U	2 U

Table A-2A
SURFACE SOIL SAMPLE RESULTS (0-2 ft.)
SEAD-59
SEAD-59 and SEAD-71 Phase II RI Report
Seneca Army Depot Activity

Facility	SEAD-59	SEAD-59	SEAD-59	SEAD-59	SEAD-59							
Location ID	WS-59-01-018-3	WS-59-01-018-4	WS-59-01-018-5	WS-59-01-018-6	WS-59-01-018-7							
Matrix	SOIL	SOIL	SOIL	SOIL	SOIL							
Sample ID	WS-59-01-018-3	WS-59-01-018-4	WS-59-01-018-5	WS-59-01-018-6	WS-59-01-018-7							
Sample Depth to Top of Sample ⁽¹⁾	0	0	0	0	0							
Sample Depth to Bottom of Sample ⁽¹⁾	0	0	0	0	0							
Sample Date	5/6/2004	5/6/2004	5/6/2004	5/6/2004	5/6/2004							
QC Code	SA	SA	SA	SA	SA							
Study ID	ENSR IRM	ENSR IRM	ENSR IRM	ENSR IRM	ENSR IRM							
Sample Round	1	1	1	1	1							
Parameter	Units	Maximum Value	Frequency of Detection	NYSDEC TAGM 4046 ⁽²⁾	Number of Exceedances	Number of Detects	Number of Analyses ⁽³⁾	Value (Q)	Value (Q)	Value (Q)	Value (Q)	Value (Q)
Alpha-BHC	UG/KG	0	0%	110	0	0	178	10 U	10 U	9.6 U	9.7 U	2 U
Alpha-Chlordane	UG/KG	34	4%		0	7	178	10 U	10 U	9.6 U	9.7 U	2 U
Beta-BHC	UG/KG	2.4	1%	200	0	1	178	10 U	10 U	9.6 U	9.7 U	2 U
Delta-BHC	UG/KG	0	0%	300	0	0	178	10 U	10 U	9.6 U	9.7 U	2 U
Dieldrin	UG/KG	0	0%	44	0	0	178	19 U	20 U	19 U	19 U	3.8 U
Endosulfan I	UG/KG	16	1%	900	0	1	178	10 U	10 U	9.6 U	9.7 U	2 U
Endosulfan II	UG/KG	0	0%	900	0	0	178	19 U	20 U	19 U	19 U	3.8 U
Endosulfan sulfate	UG/KG	6.2	1%	1000	0	1	178	19 U	20 U	19 U	19 U	3.8 U
Endrin	UG/KG	16	2%	100	0	3	178	19 U	20 U	19 U	19 U	3.8 U
Endrin aldehyde	UG/KG	4.9	1%		0	2	178	19 U	20 U	19 U	19 U	3.8 U
Endrin ketone	UG/KG	38	2%		0	4	178	19 U	20 U	19 U	19 U	3.8 U
Gamma-BHC/Lindane	UG/KG	0	0%	60	0	0	178	10 U	10 U	9.6 U	9.7 U	2 U
Gamma-Chlordane	UG/KG	24	8%	540	0	14	178	10 U	10 U	9.6 U	9.7 U	12 U
Heptachlor	UG/KG	0	0%	100	0	0	178	10 U	10 U	9.6 U	9.7 U	2 U
Heptachlor epoxide	UG/KG	3	1%	20	0	2	178	10 U	10 U	9.6 U	9.7 U	2 U
Methoxychlor	UG/KG	0	0%		0	0	178	100 U	100 U	96 U	97 U	20 U
Toxaphene	UG/KG	0	0%		0	0	178	190 U	200 U	190 U	190 U	200 U
Aroclor-1016	UG/KG	0	0%		0	0	178	39 U	39 U	37 U	38 U	38 U
Aroclor-1221	UG/KG	0	0%		0	0	178	39 U	39 U	37 U	38 U	38 U
Aroclor-1232	UG/KG	0	0%		0	0	178	39 U	39 U	37 U	38 U	38 U
Aroclor-1242	UG/KG	0	0%		0	0	178	39 U	39 U	37 U	38 U	38 U
Aroclor-1248	UG/KG	0	0%		0	0	178	39 U	39 U	37 U	38 U	38 U
Aroclor-1254	UG/KG	0	0%	10000	0	0	178	39 U	39 U	37 U	38 U	38 U
Aroclor-1260	UG/KG	79	1%	10000	0	2	178	39 U	39 U	37 U	38 U	38 U
Metals												
Aluminum	MG/KG	18300	100%	19300	0	178	178	10500	10000	8790	10300	11700 J
Antimony	MG/KG	424	58%	5.9	5	104	178	3.4 UJ	3.6 UJ	3.2 UJ	3.4 UJ	2.1 J
Arsenic	MG/KG	32.2	100%	8.2	7	178	178	4.7 J	4.1 J	3.6 J	4.4 J	5.6 J
Barium	MG/KG	304	100%	300	1	178	178	89.2	80.6	69.7	73.9	82.2 J
Beryllium	MG/KG	2.6	99%	1.1	2	176	178	0.16	0.11 J	0.05 U	0.16	0.66
Cadmium	MG/KG	3.2	86%	2.3	2	153	178	0.67	0.58 J	0.55	1.1	0.78
Calcium	MG/KG	214000	100%	121000	1	178	178	55200 J	54000 J	75600 J	42100 J	36200 J
Chromium	MG/KG	39.3	100%	29.6	2	178	178	16.8	17.6	13.8	21.3	22 J
Cobalt	MG/KG	47.8	100%	30	2	178	178	8.8	8.2	6.9	9.1	10.2 J
Copper	MG/KG	305	100%	33	19	178	178	27.8	26.9	21.2	36.5	40.8 J
Cyanide	MG/KG	0	0%	0.35	0	0	9					
Iron	MG/KG	64000	100%	36500	1	178	178	19900	18500	16000	19300	19400 J
Lead	MG/KG	164	100%	24.8	75	178	178	39.9	31.1	22.6	67.7	71.6 J
Magnesium	MG/KG	30200	100%	21500	3	178	178	12700	9830	19700	8910	7970 J
Manganese	MG/KG	1290	100%	1060	3	178	178	588	454	460	490	496 J
Mercury	MG/KG	0.95	95%	0.1	37	169	178	0.07	0.08	0.04	0.08	0.09
Nickel	MG/KG	88.3	100%	49	3	178	178	24.8	24.5	17.6	26.2	32.1 J
Potassium	MG/KG	2290	100%	2380	0	178	178	1270	1230	1180	1260	1110 J
Selenium	MG/KG	1.5	9%	2	0	16	178	0.56 U	0.59 U	0.53 U	0.56 U	0.43 J
Silver	MG/KG	2.9	49%	0.75	62	87	178	0.56 U	0.59 U	0.53 U	0.56 U	0.23 J

**Table A-2A
SURFACE SOIL SAMPLE RESULTS (0-2 ft.)
SEAD-59
SEAD-59 and SEAD-71 Phase II RI Report
Seneca Army Depot Activity**

Facility	SEAD-59	SEAD-59	SEAD-59	SEAD-59	SEAD-59
Location ID	WS-59-01-018-3	WS-59-01-018-4	WS-59-01-018-5	WS-59-01-018-6	WS-59-01-018-7
Matrix	SOIL	SOIL	SOIL	SOIL	SOIL
Sample ID	WS-59-01-018-3	WS-59-01-018-4	WS-59-01-018-5	WS-59-01-018-6	WS-59-01-018-7
Sample Depth to Top of Sample ⁽¹⁾	0	0	0	0	0
Sample Depth to Bottom of Sample ⁽¹⁾	0	0	0	0	0
Sample Date	5/6/2004	5/6/2004	5/6/2004	5/6/2004	5/6/2004
QC Code	SA	SA	SA	SA	SA
Study ID	ENSR IRM	ENSR IRM	ENSR IRM	ENSR IRM	ENSR IRM
Sample Round	1	1	1	1	1

Parameter	Units	Maximum Value	Frequency of Detection	NYSDEC TAGM 4046 ⁽²⁾	Number of Exceedances	Number of Detects	Number of Analyses ⁽³⁾	Value (Q)	Value (Q)	Value (Q)	Value (Q)	Value (Q)
Sodium	MG/KG	4060	99%	172	86	177	178	1150	1620	833	1140	991
Thallium	MG/KG	1.8	29%	0.7	24	51	178	0.58 J	0.59 U	0.54 J	0.56 U	0.2 U
Vanadium	MG/KG	28.5	100%	150	0	178	178	19.1	18.7	17.1	22.7	21.5 J
Zinc	MG/KG	341	100%	110	19	178	178	80.4 J	69.9 J	107 J	89.4 J	113

Note(s):

- (1) - Historical sample depths are presented (I.e. prior to 2002 TCRA)
- (2) - NYSDEC Technical and Administrative Guidance Memorandum (TAGM) HWR-94-4046, Revised January 24, 1994
- (3) - Sample/Duplicate pair are presented as individual samples in this table. Statistical information used Sample Duplicate pairs as a single entity and averaged result values were used in risk assessment analysis.

U = compound was not detected

J = the reported value is an estimated concentration

UJ = the compound was not detected; the associated reporting limit is approximate

R = the data was rejected in the data validating process

NJ = compound was "tentatively identified" and the associated numerical value is approximate

Table A-2A
SURFACE SOIL SAMPLE RESULTS (0-2 ft.)
SEAD-59
SEAD-59 and SEAD-71 Phase II RI Report
Seneca Army Depot Activity

Facility	SEAD-59	SEAD-59	SEAD-59	SEAD-59	SEAD-59
Location ID	WS-59-01-018-8	WS-59-02-002-1	WS-59-02-002-2	WS-59-02-002-3	WS-59-02-003-1
Matrix	SOIL	SOIL	SOIL	SOIL	SOIL
Sample ID	WS-59-01-018-8	WS-59-02-002-1	WS-59-02-002-2	WS-59-02-002-3	WS-59-02-003-1
Sample Depth to Top of Sample ⁽¹⁾	0	0	0	0	0
Sample Depth to Bottom of Sample ⁽¹⁾	0	0	0	0	0
Sample Date	5/6/2004	5/6/2004	5/6/2004	5/6/2004	5/6/2004
QC Code	SA	SA	SA	SA	SA
Study ID	ENSR IRM	ENSR IRM	ENSR IRM	ENSR IRM	ENSR IRM
Sample Round	1	1	1	1	1

Parameter	Units	Maximum Value	Frequency of Detection	NYSDEC TAGM 4046 ⁽²⁾	Number of Exceedances	Number of Detects	Number of Analyses ⁽³⁾	Value (Q)	Value (Q)	Value (Q)	Value (Q)	Value (Q)
Volatile Organics												
1,1,1-Trichloroethane	UG/KG	0	0%	800	0	0	177	6 U	5.6 U	5.7 U	5.6 U	5.7 U
1,1,2,2-Tetrachloroethane	UG/KG	0	0%	600	0	0	169	6 UJ	5.6 U	5.7 U	5.6 U	5.7 U
1,1,2-Trichloro-1,2,2-Trifluoroethane	UG/KG	0	0%		0	0	168	6 U	5.6 U	5.7 U	5.6 U	5.7 U
1,1,2-Trichloroethane	UG/KG	0	0%		0	0	107	6 U				
1,1-Dichloroethane	UG/KG	0	0%	200	0	0	177	6 U	5.6 U	5.7 U	5.6 U	5.7 U
1,1-Dichloroethene	UG/KG	8	2%	400	0	3	177	6 U	5.6 U	5.7 U	5.6 U	5.7 U
1,2,3-Trichloropropane	UG/KG	0	0%		0	0	70		5.6 U	5.7 U	5.6 U	5.7 U
1,2,4-Trichlorobenzene	UG/KG	0	0%	3400	0	0	161	6 UJ	5.6 U	5.7 U	5.6 U	5.7 U
1,2-Dibromo-3-chloropropane	UG/KG	0	0%		0	0	91	6 UJ				
1,2-Dibromoethane	UG/KG	0	0%		0	0	98	6 U				
1,2-Dichlorobenzene	UG/KG	0	0%	7900	0	0	161	6 UJ	5.6 U	5.7 U	5.6 U	5.7 U
1,2-Dichloroethane	UG/KG	0	0%	100	0	0	177	6 U	5.6 U	5.7 U	5.6 U	5.7 U
1,2-Dichloroethene (total)	UG/KG	0	0%		0	0	9					
1,2-Dichloropropane	UG/KG	0	0%		0	0	107	6 U				
1,3-Dichlorobenzene	UG/KG	0	0%	1600	0	0	161	6 UJ	5.6 U	5.7 U	5.6 U	5.7 U
1,3-Dichloropropane	UG/KG	0	0%		0	0	70		5.6 U	5.7 U	5.6 U	5.7 U
1,4-Dichlorobenzene	UG/KG	0	0%	8500	0	0	161	6 UJ	5.6 U	5.7 U	5.6 U	5.7 U
Acetone	UG/KG	550	27%	200	2	47	177	6 UJ	23 U	23 U	22 U	23 U
Benzene	UG/KG	3	4%	60	0	7	177	6 U	5.6 U	5.7 U	5.6 U	5.7 U
Bromodichloromethane	UG/KG	0	0%		0	0	107	6 U				
Bromoform	UG/KG	0	0%		0	0	107	6 U				
Carbon disulfide	UG/KG	4	3%	2700	0	6	177	6 U	5.6 U	5.7 U	5.6 U	5.7 U
Carbon tetrachloride	UG/KG	0	0%	600	0	0	177	6 U	5.6 U	5.7 U	5.6 U	5.7 U
Chlorobenzene	UG/KG	0	0%	1700	0	0	177	6 U	5.6 U	5.7 U	5.6 U	5.7 U
Chlorodibromomethane	UG/KG	0	0%		0	0	177	6 U	5.6 U	5.7 U	5.6 U	5.7 U
Chloroethane	UG/KG	0	0%	1900	0	0	177	6 U	11 U	11 U	11 U	11 U
Chloroform	UG/KG	0	0%	300	0	0	177	6 U	5.6 U	5.7 U	5.6 U	5.7 U
Cis-1,2-Dichloroethene	UG/KG	0	0%		0	0	98	6 U				
Cis-1,3-Dichloropropene	UG/KG	0	0%		0	0	107	6 U				
Cyclohexane	UG/KG	3	8%		0	8	98	6 U				
Dichlorodifluoromethane	UG/KG	0	0%		0	0	98	6 U				
Ethyl benzene	UG/KG	4.6	1%	5500	0	2	177	6 U	5.6 U	5.7 U	5.6 U	5.7 U
Isopropylbenzene	UG/KG	0	0%		0	0	98	6 U				
Meta/Para Xylene	UG/KG	9.4	4%		0	3	70		5.6 U	5.7 U	5.6 U	5.7 U
Methyl Acetate	UG/KG	2	3%		0	3	98	6 U				
Methyl Tertbutyl Ether	UG/KG	0	0%		0	0	98	6 UJ				
Methyl bromide	UG/KG	0	0%		0	0	107	6 UJ				
Methyl butyl ketone	UG/KG	0	0%		0	0	107	6 UJ				
Methyl chloride	UG/KG	0	0%		0	0	107	6 U				
Methyl cyclohexane	UG/KG	5	10%		0	10	98	6 U				
Methyl ethyl ketone	UG/KG	190	12%	300	0	22	177	6 U	11 U	11 U	11 U	11 U
Methyl isobutyl ketone	UG/KG	1.9	1%	1000	0	1	177	6 UJ	11 U	11 U	11 U	11 U
Methylene chloride	UG/KG	4.9	20%	100	0	36	178	6 UJ	5.6 U	5.7 U	5.6 U	5.7 U
Ortho Xylene	UG/KG	5.05	4%		0	3	70		5.6 U	5.7 U	5.6 U	5.7 U

**Table A-2A
SURFACE SOIL SAMPLE RESULTS (0-2 ft.)
SEAD-59
SEAD-59 and SEAD-71 Phase II RI Report
Seneca Army Depot Activity**

Facility	SEAD-59	SEAD-59	SEAD-59	SEAD-59	SEAD-59
Location ID	WS-59-01-018-8	WS-59-02-002-1	WS-59-02-002-2	WS-59-02-002-3	WS-59-02-003-1
Matrix	SOIL	SOIL	SOIL	SOIL	SOIL
Sample ID	WS-59-01-018-8	WS-59-02-002-1	WS-59-02-002-2	WS-59-02-002-3	WS-59-02-003-1
Sample Depth to Top of Sample ⁽¹⁾	0	0	0	0	0
Sample Depth to Bottom of Sample ⁽¹⁾	0	0	0	0	0
Sample Date	5/6/2004	5/6/2004	5/6/2004	5/6/2004	5/6/2004
QC Code	SA	SA	SA	SA	SA
Study ID	ENSR IRM	ENSR IRM	ENSR IRM	ENSR IRM	ENSR IRM
Sample Round	1	1	1	1	1

Parameter	Units	Maximum Value	Frequency of Detection	NYSDEC TAGM 4046 ⁽²⁾	Number of Exceedances	Number of Detects	Number of Analyses ⁽³⁾	Value (Q)	Value (Q)	Value (Q)	Value (Q)	Value (Q)
Styrene	UG/KG	0	0%		0	0	107	6 U				
Tetrachloroethene	UG/KG	6.4	3%	1400	0	5	177	6 U	5.6 U	5.7 U	5.6 U	5.7 U
Toluene	UG/KG	8	8%	1500	0	14	177	6 U	5.6 U	5.7 U	5.6 U	5.7 U
Total BTEX	MG/KG	3.25	67%		0	2	3					
Total Xylenes	UG/KG	3	7%	1200	0	7	102	6 UJ				
Trans-1,2-Dichloroethene	UG/KG	0	0%	300	0	0	168	6 U	5.6 U	5.7 U	5.6 U	5.7 U
Trans-1,3-Dichloropropene	UG/KG	0	0%		0	0	107	6 U				
Trichloroethene	UG/KG	4.5	5%	700	0	8	177	6 U	5.6 U	5.7 U	5.6 U	5.7 U
Trichlorofluoromethane	UG/KG	6	1%		0	1	98	6 U				
Vinyl chloride	UG/KG	0	0%	200	0	0	177	6 U	11 U	11 U	11 U	11 U
Semivolatile Organics												
1,1'-Biphenyl	UG/KG	254.5	2%		0	2	99	370 U				
1,2,4-Trichlorobenzene	UG/KG	0	0%	3400	0	0	9					
1,2-Dichlorobenzene	UG/KG	0	0%	7900	0	0	9					
1,3-Dichlorobenzene	UG/KG	0	0%	1600	0	0	9					
1,4-Dichlorobenzene	UG/KG	0	0%	8500	0	0	9					
2,2'-oxybis(1-Chloropropane)	UG/KG	0	0%		0	0	105	370 U				
2,4,5-Trichlorophenol	UG/KG	0	0%	100	0	0	178	930 U	370 U	370 U	370 U	380 U
2,4,6-Trichlorophenol	UG/KG	0	0%		0	0	178	370 U	370 U	370 U	370 U	380 U
2,4-Dichlorophenol	UG/KG	0	0%	400	0	0	178	370 U	370 U	370 U	370 U	380 U
2,4-Dimethylphenol	UG/KG	0	0%		0	0	108	370 U				
2,4-Dinitrophenol	UG/KG	0	0%	200	0	0	178	930 U	1900 U	1900 U	1900 U	1900 U
2,4-Dinitrotoluene	UG/KG	0	0%		0	0	178	370 U	370 U	370 U	370 U	380 U
2,6-Dinitrotoluene	UG/KG	0	0%	1000	0	0	178	370 U	370 U	370 U	370 U	380 U
2-Chloronaphthalene	UG/KG	0	0%		0	0	108	370 U				
2-Chlorophenol	UG/KG	0	0%	800	0	0	178	370 U	370 U	370 U	370 U	380 U
2-Methylnaphthalene	UG/KG	1295	19%	36400	0	34	178	120 J	370 U	370 U	370 U	380 U
2-Methylphenol	UG/KG	0	0%	100	0	0	178	370 U	370 U	370 U	370 U	380 U
2-Nitroaniline	UG/KG	0	0%	430	0	0	178	930 U	1900 U	1900 U	1900 U	1900 U
2-Nitrophenol	UG/KG	0	0%	330	0	0	178	370 U	370 U	370 U	370 U	380 U
3,3'-Dichlorobenzidine	UG/KG	0	0%		0	0	178	370 U	370 U	370 U	370 U	380 U
3-Nitroaniline	UG/KG	0	0%	500	0	0	178	930 U	1900 U	1900 U	1900 U	1900 U
4,6-Dinitro-2-methylphenol	UG/KG	0	0%		0	0	108	930 U				
4-Bromophenyl phenyl ether	UG/KG	0	0%		0	0	108	370 U				
4-Chloro-3-methylphenol	UG/KG	0	0%	240	0	0	178	370 U	370 U	370 U	370 U	380 U
4-Chloroaniline	UG/KG	1200	1%	220	1	2	178	370 U	370 U	370 U	370 U	380 U
4-Chlorophenyl phenyl ether	UG/KG	0	0%		0	0	108	370 U				
4-Methylphenol	UG/KG	150	3%	900	0	5	178	370 U	370 U	370 U	370 U	380 U
4-Nitroaniline	UG/KG	0	0%		0	0	108	930 U				
4-Nitrophenol	UG/KG	0	0%	100	0	0	178	930 U	1900 U	1900 U	1900 U	1900 U
Acenaphthene	UG/KG	2680	24%	50000	0	42	178	45 J	370 U	370 U	370 U	380 U
Acenaphthylene	UG/KG	1700	37%	41000	0	66	178	91 J	370 U	370 U	370 U	380 U
Acetophenone	UG/KG	0	0%		0	0	99	370 U				
Aniline	UG/KG	0	0%		0	0	70		370 U	370 U	370 U	380 U
Anthracene	UG/KG	4395	43%	50000	0	77	178	120 J	370 U	370 U	370 U	380 U

Table A-2A
SURFACE SOIL SAMPLE RESULTS (0-2 ft.)
SEAD-59
SEAD-59 and SEAD-71 Phase II RI Report
Seneca Army Depot Activity

Facility	SEAD-59	SEAD-59	SEAD-59	SEAD-59	SEAD-59
Location ID	WS-59-01-018-8	WS-59-02-002-1	WS-59-02-002-2	WS-59-02-002-3	WS-59-02-003-1
Matrix	SOIL	SOIL	SOIL	SOIL	SOIL
Sample ID	WS-59-01-018-8	WS-59-02-002-1	WS-59-02-002-2	WS-59-02-002-3	WS-59-02-003-1
Sample Depth to Top of Sample ⁽¹⁾	0	0	0	0	0
Sample Depth to Bottom of Sample ⁽¹⁾	0	0	0	0	0
Sample Date	5/6/2004	5/6/2004	5/6/2004	5/6/2004	5/6/2004
QC Code	SA	SA	SA	SA	SA
Study ID	ENSR IRM	ENSR IRM	ENSR IRM	ENSR IRM	ENSR IRM
Sample Round	1	1	1	1	1

Parameter	Units	Maximum Value	Frequency of Detection	NYSDEC TAGM 4046 ⁽²⁾	Number of Exceedances	Number of Detects	Number of Analyses ⁽³⁾	Value (Q)	Value (Q)	Value (Q)	Value (Q)	Value (Q)
Atrazine	UG/KG	120	1%		0	1	99	370 U				
Benzaldehyde	UG/KG	50	1%		0	1	99	370 U				
Benzo(a)anthracene	UG/KG	8900	51%	224	72	90	178	320 J	370 U	370 U	370 U	54 J
Benzo(a)pyrene	UG/KG	8050	51%	61	84	91	178	360 J	370 U	370 U	370 U	49 J
Benzo(b)fluoranthene	UG/KG	6800	52%	1100	40	92	178	480	370 U	370 U	370 U	45 J
Benzo(ghi)perylene	UG/KG	5200	46%	50000	0	82	178	240 J	370 U	370 U	370 U	380 U
Benzo(k)fluoranthene	UG/KG	7350	49%	1100	35	88	178	200 J	370 U	370 U	370 U	46 J
Benzoic Acid	UG/KG	0	0%	2700	0	0	70		1900 U	1900 U	1900 UJ	1900 UJ
Bis(2-Chloroethoxy)methane	UG/KG	0	0%		0	0	108	370 U				
Bis(2-Chloroethyl)ether	UG/KG	0	0%		0	0	108	370 U				
Bis(2-Chloroisopropyl)ether	UG/KG	0	0%		0	0	3					
Bis(2-Ethylhexyl)phthalate	UG/KG	990	19%	50000	0	34	178	84 J	370 U	370 U	370 U	380 U
Butylbenzylphthalate	UG/KG	0	0%	50000	0	0	178	370 U	370 U	370 U	370 U	380 U
Caprolactam	UG/KG	0	0%		0	0	99	370 U				
Carbazole	UG/KG	755	19%		0	20	108	370 U				
Chrysene	UG/KG	8900	51%	400	62	91	178	380	370 U	370 U	370 U	71 J
Di-n-butylphthalate	UG/KG	965	2%	8100	0	4	178	370 U	370 U	370 U	370 U	380 U
Di-n-octylphthalate	UG/KG	0	0%	50000	0	0	178	370 U	370 U	370 U	370 U	380 U
Dibenz(a,h)anthracene	UG/KG	1665	38%	14	67	68	178	54 J	370 U	370 U	370 U	380 U
Dibenzofuran	UG/KG	2350	16%	6200	0	28	178	38 J	370 U	370 U	370 U	380 U
Diethyl phthalate	UG/KG	10	1%	7100	0	1	178	370 U	370 U	370 U	370 U	380 U
Dimethylphthalate	UG/KG	0	0%	2000	0	0	178	370 U	370 U	370 U	370 U	380 U
Fluoranthene	UG/KG	23500	54%	50000	0	97	178	650	370 U	370 U	370 U	120 J
Fluorene	UG/KG	2640	28%	50000	0	49	178	55 J	370 U	370 U	370 U	380 U
Hexachlorobenzene	UG/KG	0	0%	410	0	0	178	370 U	370 U	370 U	370 U	380 U
Hexachlorobutadiene	UG/KG	0	0%		0	0	178	370 U	370 U	370 U	370 U	380 U
Hexachlorocyclopentadiene	UG/KG	0	0%		0	0	108	370 U				
Hexachloroethane	UG/KG	0	0%		0	0	178	370 U	370 U	370 U	370 U	380 U
Indeno(1,2,3-cd)pyrene	UG/KG	4950	47%	3200	2	84	178	240 J	370 U	370 U	370 U	380 U
Isophorone	UG/KG	0	0%	4400	0	0	178	370 U	370 U	370 U	370 U	380 U
N-Nitrosodiphenylamine	UG/KG	100	1%		0	1	108	370 U				
N-Nitrosodipropylamine	UG/KG	0	0%		0	0	108	370 U				
Naphthalene	UG/KG	1800	19%	13000	0	34	178	370 U	370 U	370 U	370 U	380 U
Nitrobenzene	UG/KG	0	0%	200	0	0	178	370 U	370 U	370 U	370 U	380 U
Pentachlorophenol	UG/KG	0	0%	1000	0	0	178	930 U	1900 U	1900 U	1900 U	1900 U
Phenanthrene	UG/KG	21300	51%	50000	0	90	178	390	370 U	370 U	370 U	110 J
Phenol	UG/KG	0	0%	30	0	0	178	370 U	370 U	370 U	370 U	380 U
Pyrene	UG/KG	19200	55%	50000	0	98	178	640	370 U	370 U	370 U	100 J
Pyridine	UG/KG	0	0%		0	0	100	370 U	1900 U	1900 U	1900 U	1900 U
Total Unknown PAHs as SV	MG/KG	25	100%		0	3	3					
Pesticides/PCBs												
4,4'-DDD	UG/KG	740	28%	2900	0	49	178	35	19 U	19 U	19 U	19 U
4,4'-DDE	UG/KG	2600	37%	2100	1	65	178	62 J	19 U	19 U	19 U	19 U
4,4'-DDT	UG/KG	3700	33%	2100	1	59	178	13	19 U	19 U	19 U	19 U
Aldrin	UG/KG	1.2	1%	41	0	1	178	3.8 U	9.6 U	9.6 U	9.5 U	9.7 U

**Table A-2A
SURFACE SOIL SAMPLE RESULTS (0-2 ft.)
SEAD-59
SEAD-59 and SEAD-71 Phase II RI Report
Seneca Army Depot Activity**

Facility	SEAD-59	SEAD-59	SEAD-59	SEAD-59	SEAD-59							
Location ID	WS-59-01-018-8	WS-59-02-002-1	WS-59-02-002-2	WS-59-02-002-3	WS-59-02-003-1							
Matrix	SOIL	SOIL	SOIL	SOIL	SOIL							
Sample ID	WS-59-01-018-8	WS-59-02-002-1	WS-59-02-002-2	WS-59-02-002-3	WS-59-02-003-1							
Sample Depth to Top of Sample ⁽¹⁾	0	0	0	0	0							
Sample Depth to Bottom of Sample ⁽¹⁾	0	0	0	0	0							
Sample Date	5/6/2004	5/6/2004	5/6/2004	5/6/2004	5/6/2004							
QC Code	SA	SA	SA	SA	SA							
Study ID	ENSR IRM	ENSR IRM	ENSR IRM	ENSR IRM	ENSR IRM							
Sample Round	1	1	1	1	1							
Parameter	Units	Maximum Value	Frequency of Detection	NYSDEC TAGM 4046 ⁽²⁾	Number of Exceedances	Number of Detects	Number of Analyses ⁽³⁾	Value (Q)	Value (Q)	Value (Q)	Value (Q)	Value (Q)
Alpha-BHC	UG/KG	0	0%	110	0	0	178	3.8 U	9.6 U	9.6 U	9.5 U	9.7 U
Alpha-Chlordane	UG/KG	34	4%		0	7	178	3.8 U	9.6 U	9.6 U	9.5 U	9.7 U
Beta-BHC	UG/KG	2.4	1%	200	0	1	178	3.8 U	9.6 U	9.6 U	9.5 U	9.7 U
Delta-BHC	UG/KG	0	0%	300	0	0	178	3.8 U	9.6 U	9.6 U	9.5 U	9.7 U
Dieldrin	UG/KG	0	0%	44	0	0	178	7.3 U	19 U	19 U	19 U	19 U
Endosulfan I	UG/KG	16	1%	900	0	1	178	3.8 U	9.6 U	9.6 U	9.5 U	9.7 U
Endosulfan II	UG/KG	0	0%	900	0	0	178	7.3 U	19 U	19 U	19 U	19 U
Endosulfan sulfate	UG/KG	6.2	1%	1000	0	1	178	7.3 U	19 U	19 U	19 U	19 U
Endrin	UG/KG	16	2%	100	0	3	178	7.3 U	19 U	19 U	19 U	19 U
Endrin aldehyde	UG/KG	4.9	1%		0	2	178	7.3 U	19 U	19 U	19 U	19 U
Endrin ketone	UG/KG	38	2%		0	4	178	7.3 U	19 U	19 U	19 U	19 U
Gamma-BHC/Lindane	UG/KG	0	0%	60	0	0	178	3.8 U	9.6 U	9.6 U	9.5 U	9.7 U
Gamma-Chlordane	UG/KG	24	8%	540	0	14	178	3.8 U	9.6 U	9.6 U	9.5 U	9.7 U
Heptachlor	UG/KG	0	0%	100	0	0	178	3.8 U	9.6 U	9.6 U	9.5 U	9.7 U
Heptachlor epoxide	UG/KG	3	1%	20	0	2	178	3.8 U	9.6 U	9.6 U	9.5 U	9.7 U
Methoxychlor	UG/KG	0	0%		0	0	178	38 U	96 U	96 U	95 U	97 U
Toxaphene	UG/KG	0	0%		0	0	178	380 U	190 U	190 U	190 U	190 U
Aroclor-1016	UG/KG	0	0%		0	0	178	37 U	37 U	37 U	37 U	38 U
Aroclor-1221	UG/KG	0	0%		0	0	178	37 U	37 U	37 U	37 U	38 U
Aroclor-1232	UG/KG	0	0%		0	0	178	37 U	37 U	37 U	37 U	38 U
Aroclor-1242	UG/KG	0	0%		0	0	178	37 U	37 U	37 U	37 U	38 U
Aroclor-1248	UG/KG	0	0%		0	0	178	37 U	37 U	37 U	37 U	38 U
Aroclor-1254	UG/KG	0	0%	10000	0	0	178	37 U	37 U	37 U	37 U	38 U
Aroclor-1260	UG/KG	79	1%	10000	0	2	178	37 U	37 U	37 U	37 U	38 U
Metals												
Aluminum	MG/KG	18300	100%	19300	0	178	178	9960 J	10100	10300	8950	8530
Antimony	MG/KG	424	58%	5.9	5	104	178	1.7 J	3.3 UJ	3.4 UJ	3.3 UJ	3.3 UJ
Arsenic	MG/KG	32.2	100%	8.2	7	178	178	4.7 J	5.5	4.6	4.6	5.3
Barium	MG/KG	304	100%	300	1	178	178	69.3 J	94.5	84.2	76.2	63.3
Beryllium	MG/KG	2.6	99%	1.1	2	176	178	0.52	0.23	0.2	0.18	0.15
Cadmium	MG/KG	3.2	86%	2.3	2	153	178	0.74	0.27 U	0.28 U	0.27 U	0.27 U
Calcium	MG/KG	214000	100%	121000	1	178	178	60700 J	46800	43500	43200	56800
Chromium	MG/KG	39.3	100%	29.6	2	178	178	17.7 J	16	17.1	15.2	14.5
Cobalt	MG/KG	47.8	100%	30	2	178	178	8.6 J	11.3	9.2	8.6	7.9
Copper	MG/KG	305	100%	33	19	178	178	32.8 J	23.4	25.7	22.3	23.2
Cyanide	MG/KG	0	0%	0.35	0	0	9					
Iron	MG/KG	64000	100%	36500	1	178	178	20200 J	21500 J	22700 J	19400 J	19400 J
Lead	MG/KG	164	100%	24.8	75	178	178	55.1 J	18.3 J	20.1 J	15 J	21.1 J
Magnesium	MG/KG	30200	100%	21500	3	178	178	10200 J	15400	8390	10400	8650
Manganese	MG/KG	1290	100%	1060	3	178	178	496 J	725	394	403	317
Mercury	MG/KG	0.95	95%	0.1	37	169	178	0.11	0.06	0.06	0.05	0.09
Nickel	MG/KG	88.3	100%	49	3	178	178	25.6 J	28	27.3	25.7	25.1
Potassium	MG/KG	2290	100%	2380	0	178	178	1060 J	1020	1130	966	995
Selenium	MG/KG	1.5	9%	2	0	16	178	0.39 U	0.55 U	0.56 U	0.54 U	0.55 U
Silver	MG/KG	2.9	49%	0.75	62	87	178	0.1 U	0.55 U	0.56 U	0.54 U	0.55 U

**Table A-2A
SURFACE SOIL SAMPLE RESULTS (0-2 ft.)
SEAD-59
SEAD-59 and SEAD-71 Phase II RI Report
Seneca Army Depot Activity**

Facility	SEAD-59	SEAD-59	SEAD-59	SEAD-59	SEAD-59
Location ID	WS-59-01-018-8	WS-59-02-002-1	WS-59-02-002-2	WS-59-02-002-3	WS-59-02-003-1
Matrix	SOIL	SOIL	SOIL	SOIL	SOIL
Sample ID	WS-59-01-018-8	WS-59-02-002-1	WS-59-02-002-2	WS-59-02-002-3	WS-59-02-003-1
Sample Depth to Top of Sample ⁽¹⁾	0	0	0	0	0
Sample Depth to Bottom of Sample ⁽¹⁾	0	0	0	0	0
Sample Date	5/6/2004	5/6/2004	5/6/2004	5/6/2004	5/6/2004
QC Code	SA	SA	SA	SA	SA
Study ID	ENSR IRM	ENSR IRM	ENSR IRM	ENSR IRM	ENSR IRM
Sample Round	1	1	1	1	1

Parameter	Units	Maximum Value	Frequency of Detection	NYSDEC TAGM 4046 ⁽²⁾	Number of Exceedances	Number of Detects	Number of Analyses ⁽³⁾	Value (Q)	Value (Q)	Value (Q)	Value (Q)	Value (Q)
Sodium	MG/KG	4060	99%	172	86	177	178	672 J	175	152	123	229
Thallium	MG/KG	1.8	29%	0.7	24	51	178	0.2 U	0.73 J	0.64 J	0.54 U	0.55 U
Vanadium	MG/KG	28.5	100%	150	0	178	178	18.6 J	18.6	18.4	16.3	16.6
Zinc	MG/KG	341	100%	110	19	178	178	82.3 J	64.6 J	73.8 J	67.7 J	94.3 J

Note(s):

- (1) - Historical sample depths are presented (I.e. prior to 2002 TCRA)
- (2) - NYSDEC Technical and Administrative Guidance Memorandum (TAGM) HWR-94-4046, Revised January 24, 1994
- (3) - Sample/Duplicate pair are presented as individual samples in this table. Statistical information used Sample Duplicate pairs as a single entity and averaged result values were used in risk assessment analysis.

U = compound was not detected
 J = the reported value is an estimated concentration
 UJ = the compound was not detected; the associated reporting limit is approximate
 R = the data was rejected in the data validating process
 NJ = compound was "tentatively identified" and the associated numerical value is approximate

Table A-2A
SURFACE SOIL SAMPLE RESULTS (0-2 ft.)
SEAD-59
SEAD-59 and SEAD-71 Phase II RI Report
Seneca Army Depot Activity

Facility	SEAD-59	SEAD-59	SEAD-59	SEAD-59	SEAD-59
Location ID	WS-59-02-003-2	WS-59-02-003-3	WS-59-02-003-4	WS-59-02-003-5	WS-59-02-004-1
Matrix	SOIL	SOIL	SOIL	SOIL	SOIL
Sample ID	WS-59-02-003-2	WS-59-02-003-3	WS-59-02-003-4	WS-59-02-003-5	WS-59-02-004-1
Sample Depth to Top of Sample ⁽¹⁾	0	0	0	0	0
Sample Depth to Bottom of Sample ⁽¹⁾	0	0	0	0	0
Sample Date	5/6/2004	5/6/2004	5/6/2004	5/6/2004	5/6/2004
QC Code	SA	SA	SA	SA	SA
Study ID	ENSR IRM	ENSR IRM	ENSR IRM	ENSR IRM	ENSR IRM
Sample Round	1	1	1	1	1

Parameter	Units	Maximum Value	Frequency of Detection	NYSDEC TAGM 4046 ⁽²⁾	Number of Exceedances	Number of Detects	Number of Analyses ⁽³⁾	Value (Q)	Value (Q)	Value (Q)	Value (Q)	Value (Q)
Volatile Organics												
1,1,1-Trichloroethane	UG/KG	0	0%	800	0	0	177	5.7 U	5.7 U	5.7 U	5.6 U	5.8 U
1,1,2,2-Tetrachloroethane	UG/KG	0	0%	600	0	0	169	5.7 U	5.7 U	5.7 U	5.6 U	5.8 U
1,1,2-Trichloro-1,2,2-Trifluoroethane	UG/KG	0	0%		0	0	168	5.7 U	5.7 U	5.7 U	5.6 U	5.8 U
1,1,2-Trichloroethane	UG/KG	0	0%		0	0	107					
1,1-Dichloroethane	UG/KG	0	0%	200	0	0	177	5.7 U	5.7 U	5.7 U	5.6 U	5.8 U
1,1-Dichloroethene	UG/KG	8	2%	400	0	3	177	5.7 U	5.7 U	5.7 U	5.6 U	5.8 U
1,2,3-Trichloropropane	UG/KG	0	0%		0	0	70	5.7 U	5.7 U	5.7 U	5.6 U	5.8 U
1,2,4-Trichlorobenzene	UG/KG	0	0%	3400	0	0	161	5.7 U	5.7 U	5.7 U	5.6 U	5.8 U
1,2-Dibromo-3-chloropropane	UG/KG	0	0%		0	0	91					
1,2-Dibromoethane	UG/KG	0	0%		0	0	98					
1,2-Dichlorobenzene	UG/KG	0	0%	7900	0	0	161	5.7 U	5.7 U	5.7 U	5.6 U	5.8 U
1,2-Dichloroethane	UG/KG	0	0%	100	0	0	177	5.7 U	5.7 U	5.7 U	5.6 U	5.8 U
1,2-Dichloroethene (total)	UG/KG	0	0%		0	0	9					
1,2-Dichloropropane	UG/KG	0	0%		0	0	107					
1,3-Dichlorobenzene	UG/KG	0	0%	1600	0	0	161	5.7 U	5.7 U	5.7 U	5.6 U	5.8 U
1,3-Dichloropropane	UG/KG	0	0%		0	0	70	5.7 U	5.7 U	5.7 U	5.6 U	5.8 U
1,4-Dichlorobenzene	UG/KG	0	0%	8500	0	0	161	5.7 U	5.7 U	5.7 U	5.6 U	5.8 U
Acetone	UG/KG	550	27%	200	2	47	177	23 U	23 U	23 U	22 U	23 U
Benzene	UG/KG	3	4%	60	0	7	177	5.7 U	5.7 U	5.7 U	5.6 U	5.8 U
Bromodichloromethane	UG/KG	0	0%		0	0	107					
Bromoform	UG/KG	0	0%		0	0	107					
Carbon disulfide	UG/KG	4	3%	2700	0	6	177	5.7 U	5.7 U	5.7 U	5.6 U	5.8 U
Carbon tetrachloride	UG/KG	0	0%	600	0	0	177	5.7 U	5.7 U	5.7 U	5.6 U	5.8 U
Chlorobenzene	UG/KG	0	0%	1700	0	0	177	5.7 U	5.7 U	5.7 U	5.6 U	5.8 U
Chlorodibromomethane	UG/KG	0	0%		0	0	177	5.7 U	5.7 U	5.7 U	5.6 U	5.8 U
Chloroethane	UG/KG	0	0%	1900	0	0	177	11 U	11 U	11 U	11 U	12 U
Chloroform	UG/KG	0	0%	300	0	0	177	5.7 U	5.7 U	5.7 U	5.6 U	5.8 U
Cis-1,2-Dichloroethene	UG/KG	0	0%		0	0	98					
Cis-1,3-Dichloropropene	UG/KG	0	0%		0	0	107					
Cyclohexane	UG/KG	3	8%		0	8	98					
Dichlorodifluoromethane	UG/KG	0	0%		0	0	98					
Ethyl benzene	UG/KG	4.6	1%	5500	0	2	177	5.7 U	5.7 U	5.7 U	5.6 U	5.8 U
Isopropylbenzene	UG/KG	0	0%		0	0	98					
Meta/Para Xylene	UG/KG	9.4	4%		0	3	70	5.7 U	5.7 U	5.7 U	5.6 U	5.8 U
Methyl Acetate	UG/KG	2	3%		0	3	98					
Methyl Tertbutyl Ether	UG/KG	0	0%		0	0	98					
Methyl bromide	UG/KG	0	0%		0	0	107					
Methyl butyl ketone	UG/KG	0	0%		0	0	107					
Methyl chloride	UG/KG	0	0%		0	0	107					
Methyl cyclohexane	UG/KG	5	10%		0	10	98					
Methyl ethyl ketone	UG/KG	190	12%	300	0	22	177	11 U	11 U	11 U	11 U	12 U
Methyl isobutyl ketone	UG/KG	1.9	1%	1000	0	1	177	11 U	11 U	11 U	11 U	12 U
Methylene chloride	UG/KG	4.9	20%	100	0	36	178	1.7 J	1.5 J	1.6 J	5.6 U	1.3 J
Ortho Xylene	UG/KG	5.05	4%		0	3	70	5.7 U	5.7 U	5.7 U	5.6 U	5.8 U

**Table A-2A
SURFACE SOIL SAMPLE RESULTS (0-2 ft.)
SEAD-59
SEAD-59 and SEAD-71 Phase II RI Report
Seneca Army Depot Activity**

Facility	SEAD-59	SEAD-59	SEAD-59	SEAD-59	SEAD-59
Location ID	WS-59-02-003-2	WS-59-02-003-3	WS-59-02-003-4	WS-59-02-003-5	WS-59-02-004-1
Matrix	SOIL	SOIL	SOIL	SOIL	SOIL
Sample ID	WS-59-02-003-2	WS-59-02-003-3	WS-59-02-003-4	WS-59-02-003-5	WS-59-02-004-1
Sample Depth to Top of Sample ⁽¹⁾	0	0	0	0	0
Sample Depth to Bottom of Sample ⁽¹⁾	0	0	0	0	0
Sample Date	5/6/2004	5/6/2004	5/6/2004	5/6/2004	5/6/2004
QC Code	SA	SA	SA	SA	SA
Study ID	ENSR IRM	ENSR IRM	ENSR IRM	ENSR IRM	ENSR IRM
Sample Round	1	1	1	1	1

Parameter	Units	Maximum Value	Frequency of Detection	NYSDEC TAGM 4046 ⁽²⁾	Number of Exceedances	Number of Detects	Number of Analyses ⁽³⁾	Value (Q)	Value (Q)	Value (Q)	Value (Q)	Value (Q)
Styrene	UG/KG	0	0%		0	0	107					
Tetrachloroethene	UG/KG	6.4	3%	1400	0	5	177	5.7 U	5.7 U	5.7 U	5.6 U	5.8 U
Toluene	UG/KG	8	8%	1500	0	14	177	5.7 U	5.7 U	5.7 U	5.6 U	5.8 U
Total BTEX	MG/KG	3.25	67%		0	2	3					
Total Xylenes	UG/KG	3	7%	1200	0	7	102					
Trans-1,2-Dichloroethene	UG/KG	0	0%	300	0	0	168	5.7 U	5.7 U	5.7 U	5.6 U	5.8 U
Trans-1,3-Dichloropropene	UG/KG	0	0%		0	0	107					
Trichloroethene	UG/KG	4.5	5%	700	0	8	177	5.7 U	5.7 U	5.7 U	5.6 U	5.8 U
Trichlorofluoromethane	UG/KG	6	1%		0	1	98					
Vinyl chloride	UG/KG	0	0%	200	0	0	177	11 U	11 U	11 U	11 U	12 U
Semivolatile Organics												
1,1'-Biphenyl	UG/KG	254.5	2%		0	2	99					
1,2,4-Trichlorobenzene	UG/KG	0	0%	3400	0	0	9					
1,2-Dichlorobenzene	UG/KG	0	0%	7900	0	0	9					
1,3-Dichlorobenzene	UG/KG	0	0%	1600	0	0	9					
1,4-Dichlorobenzene	UG/KG	0	0%	8500	0	0	9					
2,2'-oxybis(1-Chloropropane)	UG/KG	0	0%		0	0	105					
2,4,5-Trichlorophenol	UG/KG	0	0%	100	0	0	178	380 U	380 U	380 U	370 U	380 U
2,4,6-Trichlorophenol	UG/KG	0	0%		0	0	178	380 U	380 U	380 U	370 U	380 U
2,4-Dichlorophenol	UG/KG	0	0%	400	0	0	178	380 U	380 U	380 U	370 U	380 U
2,4-Dimethylphenol	UG/KG	0	0%		0	0	108					
2,4-Dinitrophenol	UG/KG	0	0%	200	0	0	178	1900 U	2000 U	1900 U	1900 U	2000 U
2,4-Dinitrotoluene	UG/KG	0	0%		0	0	178	380 U	380 U	380 U	370 U	380 U
2,6-Dinitrotoluene	UG/KG	0	0%	1000	0	0	178	380 U	380 U	380 U	370 U	380 U
2-Chloronaphthalene	UG/KG	0	0%		0	0	108					
2-Chlorophenol	UG/KG	0	0%	800	0	0	178	380 U	380 U	380 U	370 U	380 U
2-Methylnaphthalene	UG/KG	1295	19%	36400	0	34	178	380 U	380 U	380 U	370 U	380 U
2-Methylphenol	UG/KG	0	0%	100	0	0	178	380 U	380 U	380 U	370 U	380 U
2-Nitroaniline	UG/KG	0	0%	430	0	0	178	1900 U	2000 U	1900 U	1900 U	2000 U
2-Nitrophenol	UG/KG	0	0%	330	0	0	178	380 U	380 U	380 U	370 U	380 U
3,3'-Dichlorobenzidine	UG/KG	0	0%		0	0	178	380 U	380 U	380 U	370 U	380 U
3-Nitroaniline	UG/KG	0	0%	500	0	0	178	1900 U	2000 U	1900 U	1900 U	2000 U
4,6-Dinitro-2-methylphenol	UG/KG	0	0%		0	0	108					
4-Bromophenyl phenyl ether	UG/KG	0	0%		0	0	108					
4-Chloro-3-methylphenol	UG/KG	0	0%	240	0	0	178	380 U	380 U	380 U	370 U	380 U
4-Chloroaniline	UG/KG	1200	1%	220	1	2	178	380 U	380 U	380 U	370 U	380 U
4-Chlorophenyl phenyl ether	UG/KG	0	0%		0	0	108					
4-Methylphenol	UG/KG	150	3%	900	0	5	178	380 U	380 U	380 U	370 U	380 U
4-Nitroaniline	UG/KG	0	0%		0	0	108					
4-Nitrophenol	UG/KG	0	0%	100	0	0	178	1900 U	2000 U	1900 U	1900 U	2000 U
Acenaphthene	UG/KG	2680	24%	50000	0	42	178	380 U	380 U	380 U	370 U	380 U
Acenaphthylene	UG/KG	1700	37%	41000	0	66	178	380 U	380 U	380 U	370 U	380 U
Acetophenone	UG/KG	0	0%		0	0	99					
Aniline	UG/KG	0	0%		0	0	70	380 U	380 U	380 U	370 U	380 U
Anthracene	UG/KG	4395	43%	50000	0	77	178	48 J	380 U	380 U	370 U	380 U

Table A-2A
SURFACE SOIL SAMPLE RESULTS (0-2 ft.)
SEAD-59
SEAD-59 and SEAD-71 Phase II RI Report
Seneca Army Depot Activity

Facility	SEAD-59	SEAD-59	SEAD-59	SEAD-59	SEAD-59
Location ID	WS-59-02-003-2	WS-59-02-003-3	WS-59-02-003-4	WS-59-02-003-5	WS-59-02-004-1
Matrix	SOIL	SOIL	SOIL	SOIL	SOIL
Sample ID	WS-59-02-003-2	WS-59-02-003-3	WS-59-02-003-4	WS-59-02-003-5	WS-59-02-004-1
Sample Depth to Top of Sample ⁽¹⁾	0	0	0	0	0
Sample Depth to Bottom of Sample ⁽¹⁾	0	0	0	0	0
Sample Date	5/6/2004	5/6/2004	5/6/2004	5/6/2004	5/6/2004
QC Code	SA	SA	SA	SA	SA
Study ID	ENSR IRM	ENSR IRM	ENSR IRM	ENSR IRM	ENSR IRM
Sample Round	1	1	1	1	1

Parameter	Units	Maximum Value	Frequency of Detection	NYSDEC TAGM 4046 ⁽²⁾	Number of Exceedances	Number of Detects	Number of Analyses ⁽³⁾	Value (Q)	Value (Q)	Value (Q)	Value (Q)	Value (Q)
Atrazine	UG/KG	120	1%		0	1	99					
Benzaldehyde	UG/KG	50	1%		0	1	99					
Benzo(a)anthracene	UG/KG	8900	51%	224	72	90	178	130 J	380 U	44 J	110 J	380 U
Benzo(a)pyrene	UG/KG	8050	51%	61	84	91	178	120 J	380 U	46 J	120 J	380 U
Benzo(b)fluoranthene	UG/KG	6800	52%	1100	40	92	178	100 J	380 U	42 J	110 J	380 U
Benzo(ghi)perylene	UG/KG	5200	46%	50000	0	82	178	68 J	380 U	380 U	80 J	380 U
Benzo(k)fluoranthene	UG/KG	7350	49%	1100	35	88	178	110 J	380 U	42 J	110 J	380 U
Benzoic Acid	UG/KG	0	0%	2700	0	0	70	1900 UJ	2000 UJ	1900 UJ	1900 UJ	2000 UJ
Bis(2-Chloroethoxy)methane	UG/KG	0	0%		0	0	108					
Bis(2-Chloroethyl)ether	UG/KG	0	0%		0	0	108					
Bis(2-Chloroisopropyl)ether	UG/KG	0	0%		0	0	3					
Bis(2-Ethylhexyl)phthalate	UG/KG	990	19%	50000	0	34	178	380 U	380 U	380 U	370 U	380 U
Butylbenzylphthalate	UG/KG	0	0%	50000	0	0	178	380 U	380 U	380 U	370 U	380 U
Caprolactam	UG/KG	0	0%		0	0	99					
Carbazole	UG/KG	755	19%		0	20	108					
Chrysene	UG/KG	8900	51%	400	62	91	178	130 J	380 U	51 J	130 J	380 U
Di-n-butylphthalate	UG/KG	965	2%	8100	0	4	178	380 U	380 U	380 U	370 U	380 U
Di-n-octylphthalate	UG/KG	0	0%	50000	0	0	178	380 U	380 U	380 U	370 U	380 U
Dibenz(a,h)anthracene	UG/KG	1665	38%	14	67	68	178	380 U	380 U	380 U	370 U	380 U
Dibenzofuran	UG/KG	2350	16%	6200	0	28	178	380 U	380 U	380 U	370 U	380 U
Diethyl phthalate	UG/KG	10	1%	7100	0	1	178	380 U	380 U	380 U	370 U	380 U
Dimethylphthalate	UG/KG	0	0%	2000	0	0	178	380 U	380 U	380 U	370 U	380 U
Fluoranthene	UG/KG	23500	54%	50000	0	97	178	300 J	380 U	85 J	220 J	71 J
Fluorene	UG/KG	2640	28%	50000	0	49	178	380 U	380 U	380 U	370 U	380 U
Hexachlorobenzene	UG/KG	0	0%	410	0	0	178	380 U	380 U	380 U	370 U	380 U
Hexachlorobutadiene	UG/KG	0	0%		0	0	178	380 U	380 U	380 U	370 U	380 U
Hexachlorocyclopentadiene	UG/KG	0	0%		0	0	108					
Hexachloroethane	UG/KG	0	0%		0	0	178	380 U	380 U	380 U	370 U	380 U
Indeno(1,2,3-cd)pyrene	UG/KG	4950	47%	3200	2	84	178	66 J	380 U	380 U	74 J	380 U
Isophorone	UG/KG	0	0%	4400	0	0	178	380 U	380 U	380 U	370 U	380 U
N-Nitrosodiphenylamine	UG/KG	100	1%		0	1	108					
N-Nitrosodipropylamine	UG/KG	0	0%		0	0	108					
Naphthalene	UG/KG	1800	19%	13000	0	34	178	380 U	380 U	380 U	370 U	380 U
Nitrobenzene	UG/KG	0	0%	200	0	0	178	380 U	380 U	380 U	370 U	380 U
Pentachlorophenol	UG/KG	0	0%	1000	0	0	178	1900 U	2000 U	1900 U	1900 U	2000 U
Phenanthrene	UG/KG	21300	51%	50000	0	90	178	200 J	380 U	45 J	94 J	62 J
Phenol	UG/KG	0	0%	30	0	0	178	380 U	380 U	380 U	370 U	380 U
Pyrene	UG/KG	19200	55%	50000	0	98	178	220 J	380 U	73 J	180 J	58 J
Pyridine	UG/KG	0	0%		0	0	100	1900 U	2000 U	1900 U	1900 U	2000 U
Total Unknown PAHs as SV	MG/KG	25	100%		0	3	3					
Pesticides/PCBs												
4,4'-DDD	UG/KG	740	28%	2900	0	49	178	19 U	19 U	19 U	19 U	19 U
4,4'-DDE	UG/KG	2600	37%	2100	1	65	178	19 U	19 U	19 U	47	19 U
4,4'-DDT	UG/KG	3700	33%	2100	1	59	178	19 U	19 U	19 U	84	19 U
Aldrin	UG/KG	1.2	1%	41	0	1	178	9.7 U	9.8 U	9.7 U	9.5 U	9.9 U

Table A-2A
SURFACE SOIL SAMPLE RESULTS (0-2 ft.)
SEAD-59
SEAD-59 and SEAD-71 Phase II RI Report
Seneca Army Depot Activity

Facility	SEAD-59	SEAD-59	SEAD-59	SEAD-59	SEAD-59							
Location ID	WS-59-02-003-2	WS-59-02-003-3	WS-59-02-003-4	WS-59-02-003-5	WS-59-02-004-1							
Matrix	SOIL	SOIL	SOIL	SOIL	SOIL							
Sample ID	WS-59-02-003-2	WS-59-02-003-3	WS-59-02-003-4	WS-59-02-003-5	WS-59-02-004-1							
Sample Depth to Top of Sample ⁽¹⁾	0	0	0	0	0							
Sample Depth to Bottom of Sample ⁽¹⁾	0	0	0	0	0							
Sample Date	5/6/2004	5/6/2004	5/6/2004	5/6/2004	5/6/2004							
QC Code	SA	SA	SA	SA	SA							
Study ID	ENSR IRM	ENSR IRM	ENSR IRM	ENSR IRM	ENSR IRM							
Sample Round	1	1	1	1	1							
Parameter	Units	Maximum Value	Frequency of Detection	NYSDEC TAGM 4046 ⁽²⁾	Number of Exceedances	Number of Detects	Number of Analyses ⁽³⁾	Value (Q)	Value (Q)	Value (Q)	Value (Q)	Value (Q)
Alpha-BHC	UG/KG	0	0%	110	0	0	178	9.7 U	9.8 U	9.7 U	9.5 U	9.9 U
Alpha-Chlordane	UG/KG	34	4%		0	7	178	9.7 U	9.8 U	9.7 U	9.5 U	9.9 U
Beta-BHC	UG/KG	2.4	1%	200	0	1	178	9.7 U	9.8 U	9.7 U	9.5 U	9.9 U
Delta-BHC	UG/KG	0	0%	300	0	0	178	9.7 U	9.8 U	9.7 U	9.5 U	9.9 U
Dieldrin	UG/KG	0	0%	44	0	0	178	19 U	19 U	19 U	19 U	19 U
Endosulfan I	UG/KG	16	1%	900	0	1	178	9.7 U	9.8 U	9.7 U	9.5 U	9.9 U
Endosulfan II	UG/KG	0	0%	900	0	0	178	19 U	19 U	19 U	19 U	19 U
Endosulfan sulfate	UG/KG	6.2	1%	1000	0	1	178	19 U	19 U	19 U	19 U	19 U
Endrin	UG/KG	16	2%	100	0	3	178	19 U	19 U	19 U	19 U	19 U
Endrin aldehyde	UG/KG	4.9	1%		0	2	178	19 U	19 U	19 U	19 U	19 U
Endrin ketone	UG/KG	38	2%		0	4	178	19 U	19 U	19 U	19 U	19 U
Gamma-BHC/Lindane	UG/KG	0	0%	60	0	0	178	9.7 U	9.8 U	9.7 U	9.5 U	9.9 U
Gamma-Chlordane	UG/KG	24	8%	540	0	14	178	9.7 U	9.8 U	9.7 U	9.5 U	9.9 U
Heptachlor	UG/KG	0	0%	100	0	0	178	9.7 U	9.8 U	9.7 U	9.5 U	9.9 U
Heptachlor epoxide	UG/KG	3	1%	20	0	2	178	9.7 U	9.8 U	9.7 U	9.5 U	9.9 U
Methoxychlor	UG/KG	0	0%		0	0	178	97 U	98 U	97 U	95 U	99 U
Toxaphene	UG/KG	0	0%		0	0	178	190 U	190 U	190 U	190 U	190 U
Aroclor-1016	UG/KG	0	0%		0	0	178	38 U	38 U	38 U	37 U	38 U
Aroclor-1221	UG/KG	0	0%		0	0	178	38 U	38 U	38 U	37 U	38 U
Aroclor-1232	UG/KG	0	0%		0	0	178	38 U	38 U	38 U	37 U	38 U
Aroclor-1242	UG/KG	0	0%		0	0	178	38 U	38 U	38 U	37 U	38 U
Aroclor-1248	UG/KG	0	0%		0	0	178	38 U	38 U	38 U	37 U	38 U
Aroclor-1254	UG/KG	0	0%	10000	0	0	178	38 U	38 U	38 U	37 U	38 U
Aroclor-1260	UG/KG	79	1%	10000	0	2	178	38 U	38 U	38 U	37 U	38 U
Metals												
Aluminum	MG/KG	18300	100%	19300	0	178	178	11700	10500	10800	11500	7740
Antimony	MG/KG	424	58%	5.9	5	104	178	3.3 UJ	3.4 UJ	3.3 UJ	3.2 UJ	3.3 UJ
Arsenic	MG/KG	32.2	100%	8.2	7	178	178	5.5	4.9	4.6	5.1	6.9
Barium	MG/KG	304	100%	300	1	178	178	98.6	99.5	79.4	106	54
Beryllium	MG/KG	2.6	99%	1.1	2	176	178	0.27	0.26	0.21	0.22	0.12
Cadmium	MG/KG	3.2	86%	2.3	2	153	178	0.28 U	0.28 U	0.27 U	0.26 U	0.28 U
Calcium	MG/KG	214000	100%	121000	1	178	178	30200	33600	19000	21500	71500
Chromium	MG/KG	39.3	100%	29.6	2	178	178	19	17.3	18	17.7	14.1
Cobalt	MG/KG	47.8	100%	30	2	178	178	9.8	11.1	8.9	10.9	6.9
Copper	MG/KG	305	100%	33	19	178	178	29	26	23.4	23.8	22.6
Cyanide	MG/KG	0	0%	0.35	0	0	9					
Iron	MG/KG	64000	100%	36500	1	178	178	23400 J	21900 J	20700 J	21600 J	17300 J
Lead	MG/KG	164	100%	24.8	75	178	178	29.3 J	24.7 J	20.2 J	26.6 J	11.7 J
Magnesium	MG/KG	30200	100%	21500	3	178	178	6930	9220	6340	6140	15700
Manganese	MG/KG	1290	100%	1060	3	178	178	413	661	320	749	349
Mercury	MG/KG	0.95	95%	0.1	37	169	178	0.1	0.07	0.07	0.07	0.03 J
Nickel	MG/KG	88.3	100%	49	3	178	178	32.1	28.9	28.1	26.7	22.4
Potassium	MG/KG	2290	100%	2380	0	178	178	1240	1040	1010	1190	932
Selenium	MG/KG	1.5	9%	2	0	16	178	0.55 U	0.56 U	0.55 U	0.53 U	0.55 U
Silver	MG/KG	2.9	49%	0.75	62	87	178	0.55 U	0.56 U	0.55 U	0.53 U	0.55 U

**Table A-2A
SURFACE SOIL SAMPLE RESULTS (0-2 ft.)
SEAD-59
SEAD-59 and SEAD-71 Phase II RI Report
Seneca Army Depot Activity**

Facility	SEAD-59	SEAD-59	SEAD-59	SEAD-59	SEAD-59
Location ID	WS-59-02-003-2	WS-59-02-003-3	WS-59-02-003-4	WS-59-02-003-5	WS-59-02-004-1
Matrix	SOIL	SOIL	SOIL	SOIL	SOIL
Sample ID	WS-59-02-003-2	WS-59-02-003-3	WS-59-02-003-4	WS-59-02-003-5	WS-59-02-004-1
Sample Depth to Top of Sample ⁽¹⁾	0	0	0	0	0
Sample Depth to Bottom of Sample ⁽¹⁾	0	0	0	0	0
Sample Date	5/6/2004	5/6/2004	5/6/2004	5/6/2004	5/6/2004
QC Code	SA	SA	SA	SA	SA
Study ID	ENSR IRM	ENSR IRM	ENSR IRM	ENSR IRM	ENSR IRM
Sample Round	1	1	1	1	1

Parameter	Units	Maximum Value	Frequency of Detection	NYSDEC TAGM 4046 ⁽²⁾	Number of Exceedances	Number of Detects	Number of Analyses ⁽³⁾	Value (Q)	Value (Q)	Value (Q)	Value (Q)	Value (Q)
Sodium	MG/KG	4060	99%	172	86	177	178	124	122	199	66.3	545
Thallium	MG/KG	1.8	29%	0.7	24	51	178	0.74 J	0.74 J	0.55 U	0.84 J	0.55 U
Vanadium	MG/KG	28.5	100%	150	0	178	178	20.7	18.8	18.1	20.7	14.4
Zinc	MG/KG	341	100%	110	19	178	178	88.5 J	74.2 J	81.6 J	74.5 J	65.7 J

Note(s):

- (1) - Historical sample depths are presented (I.e. prior to 2002 TCRA)
- (2) - NYSDEC Technical and Administrative Guidance Memorandum (TAGM) HWR-94-4046, Revised January 24, 1994
- (3) - Sample/Duplicate pair are presented as individual samples in this table. Statistical information used Sample Duplicate pairs as a single entity and averaged result values were used in risk assessment analysis.

U = compound was not detected
 J = the reported value is an estimated concentration
 UJ = the compound was not detected; the associated reporting limit is approximate
 R = the data was rejected in the data validating process
 NJ = compound was "tentatively identified" and the associated numerical value is approximate

**Table A-2A
SURFACE SOIL SAMPLE RESULTS (0-2 ft.)
SEAD-59
SEAD-59 and SEAD-71 Phase II RI Report
Seneca Army Depot Activity**

Facility	SEAD-59	SEAD-59	SEAD-59	SEAD-59	SEAD-59
Location ID	WS-59-03-001-1	WS-59-03-001-2	WS-59-03-002-1	WS-59-03-002-2	WS-59-03-002-3
Matrix	SOIL	SOIL	SOIL	SOIL	SOIL
Sample ID	WS-59-03-001-1	WS-59-03-001-2	WS-59-03-002-1	WS-59-03-002-2	WS-59-03-002-3
Sample Depth to Top of Sample ⁽¹⁾	0	0	0	0	0
Sample Depth to Bottom of Sample ⁽¹⁾	0	0	0	0	0
Sample Date	5/6/2004	5/6/2004	5/6/2004	5/6/2004	5/6/2004
QC Code	SA	SA	SA	SA	SA
Study ID	ENSR IRM	ENSR IRM	ENSR IRM	ENSR IRM	ENSR IRM
Sample Round	1	1	1	1	1

Parameter	Units	Maximum Value	Frequency of Detection	NYSDEC TAGM 4046 ⁽²⁾	Number of Exceedances	Number of Detects	Number of Analyses ⁽³⁾	Value (Q)	Value (Q)	Value (Q)	Value (Q)	Value (Q)
Volatile Organics												
1,1,1-Trichloroethane	UG/KG	0	0%	800	0	0	177	5.6 U	5.7 U	5.7 U	5.7 U	5.7 U
1,1,2,2-Tetrachloroethane	UG/KG	0	0%	600	0	0	169	5.6 U	5.7 U	5.7 U	5.7 U	5.7 U
1,1,2-Trichloro-1,2,2-Trifluoroethane	UG/KG	0	0%		0	0	168	5.6 U	5.7 U	5.7 U	5.7 U	5.7 U
1,1,2-Trichloroethane	UG/KG	0	0%		0	0	107					
1,1-Dichloroethane	UG/KG	0	0%	200	0	0	177	5.6 U	5.7 U	5.7 U	5.7 U	5.7 U
1,1-Dichloroethene	UG/KG	8	2%	400	0	3	177	5.6 U	5.7 U	5.7 U	5.7 U	5.7 U
1,2,3-Trichloropropane	UG/KG	0	0%		0	0	70	5.6 U	5.7 U	5.7 U	5.7 U	5.7 U
1,2,4-Trichlorobenzene	UG/KG	0	0%	3400	0	0	161	5.6 U	5.7 U	5.7 U	5.7 U	5.7 U
1,2-Dibromo-3-chloropropane	UG/KG	0	0%		0	0	91					
1,2-Dibromoethane	UG/KG	0	0%		0	0	98					
1,2-Dichlorobenzene	UG/KG	0	0%	7900	0	0	161	5.6 U	5.7 U	5.7 U	5.7 U	5.7 U
1,2-Dichloroethane	UG/KG	0	0%	100	0	0	177	5.6 U	5.7 U	5.7 U	5.7 U	5.7 U
1,2-Dichloroethene (total)	UG/KG	0	0%		0	0	9					
1,2-Dichloropropane	UG/KG	0	0%		0	0	107					
1,3-Dichlorobenzene	UG/KG	0	0%	1600	0	0	161	5.6 U	5.7 U	5.7 U	5.7 U	5.7 U
1,3-Dichloropropane	UG/KG	0	0%		0	0	70	5.6 U	5.7 U	5.7 U	5.7 U	5.7 U
1,4-Dichlorobenzene	UG/KG	0	0%	8500	0	0	161	5.6 U	5.7 U	5.7 U	5.7 U	5.7 U
Acetone	UG/KG	550	27%	200	2	47	177	22 U	23 U	23 U	23 U	23 U
Benzene	UG/KG	3	4%	60	0	7	177	5.6 U	5.7 U	5.7 U	5.7 U	5.7 U
Bromodichloromethane	UG/KG	0	0%		0	0	107					
Bromoform	UG/KG	0	0%		0	0	107					
Carbon disulfide	UG/KG	4	3%	2700	0	6	177	5.6 U	5.7 U	5.7 U	5.7 U	5.7 U
Carbon tetrachloride	UG/KG	0	0%	600	0	0	177	5.6 U	5.7 U	5.7 U	5.7 U	5.7 U
Chlorobenzene	UG/KG	0	0%	1700	0	0	177	5.6 U	5.7 U	5.7 U	5.7 U	5.7 U
Chlorodibromomethane	UG/KG	0	0%		0	0	177	5.6 U	5.7 U	5.7 U	5.7 U	5.7 U
Chloroethane	UG/KG	0	0%	1900	0	0	177	11 U	11 U	11 U	11 U	11 U
Chloroform	UG/KG	0	0%	300	0	0	177	5.6 U	5.7 U	5.7 U	5.7 U	5.7 U
Cis-1,2-Dichloroethene	UG/KG	0	0%		0	0	98					
Cis-1,3-Dichloropropene	UG/KG	0	0%		0	0	107					
Cyclohexane	UG/KG	3	8%		0	8	98					
Dichlorodifluoromethane	UG/KG	0	0%		0	0	98					
Ethyl benzene	UG/KG	4.6	1%	5500	0	2	177	5.6 U	2.3 J	5.7 U	5.7 U	5.7 U
Isopropylbenzene	UG/KG	0	0%		0	0	98					
Meta/Para Xylene	UG/KG	9.4	4%		0	3	70	5.6 U	8.4	5.7 U	5.7 U	5.7 U
Methyl Acetate	UG/KG	2	3%		0	3	98					
Methyl Tertbutyl Ether	UG/KG	0	0%		0	0	98					
Methyl bromide	UG/KG	0	0%		0	0	107					
Methyl butyl ketone	UG/KG	0	0%		0	0	107					
Methyl chloride	UG/KG	0	0%		0	0	107					
Methyl cyclohexane	UG/KG	5	10%		0	10	98					
Methyl ethyl ketone	UG/KG	190	12%	300	0	22	177	11 U	11 U	11 U	11 U	11 U
Methyl isobutyl ketone	UG/KG	1.9	1%	1000	0	1	177	11 U	11 U	11 U	11 U	11 U
Methylene chloride	UG/KG	4.9	20%	100	0	36	178	5.6 U	1.7 J	1.7 J	1.4 J	1.5 J
Ortho Xylene	UG/KG	5.05	4%		0	3	70	5.6 U	3.1 J	5.7 U	5.7 U	5.7 U

Table A-2A
SURFACE SOIL SAMPLE RESULTS (0-2 ft.)
SEAD-59
SEAD-59 and SEAD-71 Phase II RI Report
Seneca Army Depot Activity

Facility	SEAD-59	SEAD-59	SEAD-59	SEAD-59	SEAD-59
Location ID	WS-59-03-001-1	WS-59-03-001-2	WS-59-03-002-1	WS-59-03-002-2	WS-59-03-002-3
Matrix	SOIL	SOIL	SOIL	SOIL	SOIL
Sample ID	WS-59-03-001-1	WS-59-03-001-2	WS-59-03-002-1	WS-59-03-002-2	WS-59-03-002-3
Sample Depth to Top of Sample ⁽¹⁾	0	0	0	0	0
Sample Depth to Bottom of Sample ⁽¹⁾	0	0	0	0	0
Sample Date	5/6/2004	5/6/2004	5/6/2004	5/6/2004	5/6/2004
QC Code	SA	SA	SA	SA	SA
Study ID	ENSR IRM	ENSR IRM	ENSR IRM	ENSR IRM	ENSR IRM
Sample Round	1	1	1	1	1

Parameter	Units	Maximum Value	Frequency of Detection	NYSDEC TAGM 4046 ⁽²⁾	Number of Exceedances	Number of Detects	Number of Analyses ⁽³⁾	Value (Q)	Value (Q)	Value (Q)	Value (Q)	Value (Q)
Styrene	UG/KG	0	0%		0	0	107					
Tetrachloroethene	UG/KG	6.4	3%	1400	0	5	177	5.6 U	5.7 U	5.7 U	5.7 U	5.7 U
Toluene	UG/KG	8	8%	1500	0	14	177	5.6 U	4 J	5.7 U	5.7 U	5.7 U
Total BTEX	MG/KG	3.25	67%		0	2	3					
Total Xylenes	UG/KG	3	7%	1200	0	7	102					
Trans-1,2-Dichloroethene	UG/KG	0	0%	300	0	0	168	5.6 U	5.7 U	5.7 U	5.7 U	5.7 U
Trans-1,3-Dichloropropene	UG/KG	0	0%		0	0	107					
Trichloroethene	UG/KG	4.5	5%	700	0	8	177	5.6 U	5.7 U	5.7 U	5.7 U	5.7 U
Trichlorofluoromethane	UG/KG	6	1%		0	1	98					
Vinyl chloride	UG/KG	0	0%	200	0	0	177	11 U	11 U	11 U	11 U	11 U
Semivolatile Organics												
1,1'-Biphenyl	UG/KG	254.5	2%		0	2	99					
1,2,4-Trichlorobenzene	UG/KG	0	0%	3400	0	0	9					
1,2-Dichlorobenzene	UG/KG	0	0%	7900	0	0	9					
1,3-Dichlorobenzene	UG/KG	0	0%	1600	0	0	9					
1,4-Dichlorobenzene	UG/KG	0	0%	8500	0	0	9					
2,2'-oxybis(1-Chloropropane)	UG/KG	0	0%		0	0	105					
2,4,5-Trichlorophenol	UG/KG	0	0%	100	0	0	178	370 U	380 U	380 U	380 U	380 U
2,4,6-Trichlorophenol	UG/KG	0	0%		0	0	178	370 U	380 U	380 U	380 U	380 U
2,4-Dichlorophenol	UG/KG	0	0%	400	0	0	178	370 U	380 U	380 U	380 U	380 U
2,4-Dimethylphenol	UG/KG	0	0%		0	0	108					
2,4-Dinitrophenol	UG/KG	0	0%	200	0	0	178	1900 U	1900 U	1900 U	1900 U	1900 U
2,4-Dinitrotoluene	UG/KG	0	0%		0	0	178	370 UJ	380 U	380 U	380 U	380 U
2,6-Dinitrotoluene	UG/KG	0	0%	1000	0	0	178	370 UJ	380 U	380 U	380 U	380 U
2-Chloronaphthalene	UG/KG	0	0%		0	0	108					
2-Chlorophenol	UG/KG	0	0%	800	0	0	178	370 U	380 U	380 U	380 U	380 U
2-Methylnaphthalene	UG/KG	1295	19%	36400	0	34	178	370 UJ	380 U	380 U	380 U	380 U
2-Methylphenol	UG/KG	0	0%	100	0	0	178	370 U	380 U	380 U	380 U	380 U
2-Nitroaniline	UG/KG	0	0%	430	0	0	178	1900 UJ	1900 U	1900 U	1900 U	1900 U
2-Nitrophenol	UG/KG	0	0%	330	0	0	178	370 U	380 U	380 U	380 U	380 U
3,3'-Dichlorobenzidine	UG/KG	0	0%		0	0	178	370 UJ	380 U	380 U	380 U	380 U
3-Nitroaniline	UG/KG	0	0%	500	0	0	178	1900 UJ	1900 U	1900 U	1900 U	1900 U
4,6-Dinitro-2-methylphenol	UG/KG	0	0%		0	0	108					
4-Bromophenyl phenyl ether	UG/KG	0	0%		0	0	108					
4-Chloro-3-methylphenol	UG/KG	0	0%	240	0	0	178	370 U	380 U	380 U	380 U	380 U
4-Chloroaniline	UG/KG	1200	1%	220	1	2	178	370 UJ	380 U	380 U	380 U	380 U
4-Chlorophenyl phenyl ether	UG/KG	0	0%		0	0	108					
4-Methylphenol	UG/KG	150	3%	900	0	5	178	370 U	380 U	380 U	380 U	380 U
4-Nitroaniline	UG/KG	0	0%		0	0	108					
4-Nitrophenol	UG/KG	0	0%	100	0	0	178	1900 U	1900 U	1900 U	1900 U	1900 U
Acenaphthene	UG/KG	2680	24%	50000	0	42	178	370 UJ	380 U	380 U	380 U	380 U
Acenaphthylene	UG/KG	1700	37%	41000	0	66	178	370 UJ	380 U	380 U	380 U	380 U
Acetophenone	UG/KG	0	0%		0	0	99					
Aniline	UG/KG	0	0%		0	0	70	370 UJ	380 U	380 U	380 U	380 U
Anthracene	UG/KG	4395	43%	50000	0	77	178	58 J	380 U	380 U	380 U	380 U

**Table A-2A
SURFACE SOIL SAMPLE RESULTS (0-2 ft.)
SEAD-59
SEAD-59 and SEAD-71 Phase II RI Report
Seneca Army Depot Activity**

Facility	SEAD-59	SEAD-59	SEAD-59	SEAD-59	SEAD-59
Location ID	WS-59-03-001-1	WS-59-03-001-2	WS-59-03-002-1	WS-59-03-002-2	WS-59-03-002-3
Matrix	SOIL	SOIL	SOIL	SOIL	SOIL
Sample ID	WS-59-03-001-1	WS-59-03-001-2	WS-59-03-002-1	WS-59-03-002-2	WS-59-03-002-3
Sample Depth to Top of Sample ⁽¹⁾	0	0	0	0	0
Sample Depth to Bottom of Sample ⁽¹⁾	0	0	0	0	0
Sample Date	5/6/2004	5/6/2004	5/6/2004	5/6/2004	5/6/2004
QC Code	SA	SA	SA	SA	SA
Study ID	ENSR IRM	ENSR IRM	ENSR IRM	ENSR IRM	ENSR IRM
Sample Round	1	1	1	1	1

Parameter	Units	Maximum Value	Frequency of Detection	NYSDEC TAGM 4046 ⁽²⁾	Number of Exceedances	Number of Detects	Number of Analyses ⁽³⁾	Value (Q)	Value (Q)	Value (Q)	Value (Q)	Value (Q)
Atrazine	UG/KG	120	1%		0	1	99					
Benzaldehyde	UG/KG	50	1%		0	1	99					
Benzo(a)anthracene	UG/KG	8900	51%	224	72	90	178	210 J	380 U	380 U	380 U	380 U
Benzo(a)pyrene	UG/KG	8050	51%	61	84	91	178	180 J	380 U	380 U	380 U	380 U
Benzo(b)fluoranthene	UG/KG	6800	52%	1100	40	92	178	160 J	380 U	380 U	380 U	380 U
Benzo(ghi)perylene	UG/KG	5200	46%	50000	0	82	178	120 J	380 U	380 U	380 U	380 U
Benzo(k)fluoranthene	UG/KG	7350	49%	1100	35	88	178	160 J	380 U	380 U	380 U	380 U
Benzoic Acid	UG/KG	0	0%	2700	0	0	70	1900 UJ	1900 U	1900 U	1900 U	1900 U
Bis(2-Chloroethoxy)methane	UG/KG	0	0%		0	0	108					
Bis(2-Chloroethyl)ether	UG/KG	0	0%		0	0	108					
Bis(2-Chloroisopropyl)ether	UG/KG	0	0%		0	0	3					
Bis(2-Ethylhexyl)phthalate	UG/KG	990	19%	50000	0	34	178	370 UJ	380 U	380 U	380 U	380 U
Butylbenzylphthalate	UG/KG	0	0%	50000	0	0	178	370 UJ	380 U	380 U	380 U	380 U
Caprolactam	UG/KG	0	0%		0	0	99					
Carbazole	UG/KG	755	19%		0	20	108					
Chrysene	UG/KG	8900	51%	400	62	91	178	240 J	380 U	380 U	380 U	380 U
Di-n-butylphthalate	UG/KG	965	2%	8100	0	4	178	370 UJ	380 U	380 U	380 U	380 U
Di-n-octylphthalate	UG/KG	0	0%	50000	0	0	178	370 UJ	380 U	380 U	380 U	380 U
Dibenz(a,h)anthracene	UG/KG	1665	38%	14	67	68	178	370 UJ	380 U	380 U	380 U	380 U
Dibenzofuran	UG/KG	2350	16%	6200	0	28	178	370 UJ	380 U	380 U	380 U	380 U
Diethyl phthalate	UG/KG	10	1%	7100	0	1	178	370 UJ	380 U	380 U	380 U	380 U
Dimethylphthalate	UG/KG	0	0%	2000	0	0	178	370 UJ	380 U	380 U	380 U	380 U
Fluoranthene	UG/KG	23500	54%	50000	0	97	178	380 J	380 U	380 U	380 U	380 U
Fluorene	UG/KG	2640	28%	50000	0	49	178	370 UJ	380 U	380 U	380 U	380 U
Hexachlorobenzene	UG/KG	0	0%	410	0	0	178	370 UJ	380 U	380 U	380 U	380 U
Hexachlorobutadiene	UG/KG	0	0%		0	0	178	370 UJ	380 U	380 U	380 U	380 U
Hexachlorocyclopentadiene	UG/KG	0	0%		0	0	108					
Hexachloroethane	UG/KG	0	0%		0	0	178	370 UJ	380 U	380 U	380 U	380 U
Indeno(1,2,3-cd)pyrene	UG/KG	4950	47%	3200	2	84	178	120 J	380 U	380 U	380 U	380 U
Isophorone	UG/KG	0	0%	4400	0	0	178	370 UJ	380 U	380 U	380 U	380 U
N-Nitrosodiphenylamine	UG/KG	100	1%		0	1	108					
N-Nitrosodipropylamine	UG/KG	0	0%		0	0	108					
Naphthalene	UG/KG	1800	19%	13000	0	34	178	370 UJ	380 U	380 U	380 U	380 U
Nitrobenzene	UG/KG	0	0%	200	0	0	178	370 UJ	380 U	380 U	380 U	380 U
Pentachlorophenol	UG/KG	0	0%	1000	0	0	178	1900 U	1900 U	1900 U	1900 U	1900 U
Phenanthrene	UG/KG	21300	51%	50000	0	90	178	190 J	380 U	380 U	380 U	380 U
Phenol	UG/KG	0	0%	30	0	0	178	370 U	380 U	380 U	380 U	380 U
Pyrene	UG/KG	19200	55%	50000	0	98	178	340 J	380 U	380 U	380 U	380 U
Pyridine	UG/KG	0	0%		0	0	100	1900 UJ	1900 U	1900 U	1900 U	1900 U
Total Unknown PAHs as SV	MG/KG	25	100%		0	3	3					
Pesticides/PCBs												
4,4'-DDD	UG/KG	740	28%	2900	0	49	178	19 U	19 U	19 U	19 U	19 U
4,4'-DDE	UG/KG	2600	37%	2100	1	65	178	19 U	19 U	19 U	19 U	19 U
4,4'-DDT	UG/KG	3700	33%	2100	1	59	178	19 U	19 U	19 U	19 U	19 U
Aldrin	UG/KG	1.2	1%	41	0	1	178	9.6 U	9.7 U	9.7 U	9.7 U	9.7 U

**Table A-2A
SURFACE SOIL SAMPLE RESULTS (0-2 ft.)
SEAD-59
SEAD-59 and SEAD-71 Phase II RI Report
Seneca Army Depot Activity**

Facility	SEAD-59	SEAD-59	SEAD-59	SEAD-59	SEAD-59
Location ID	WS-59-03-001-1	WS-59-03-001-2	WS-59-03-002-1	WS-59-03-002-2	WS-59-03-002-3
Matrix	SOIL	SOIL	SOIL	SOIL	SOIL
Sample ID	WS-59-03-001-1	WS-59-03-001-2	WS-59-03-002-1	WS-59-03-002-2	WS-59-03-002-3
Sample Depth to Top of Sample ⁽¹⁾	0	0	0	0	0
Sample Depth to Bottom of Sample ⁽¹⁾	0	0	0	0	0
Sample Date	5/6/2004	5/6/2004	5/6/2004	5/6/2004	5/6/2004
QC Code	SA	SA	SA	SA	SA
Study ID	ENSR IRM	ENSR IRM	ENSR IRM	ENSR IRM	ENSR IRM
Sample Round	1	1	1	1	1

Parameter	Units	Maximum Value	Frequency of Detection	NYSDEC TAGM 4046 ⁽²⁾	Number of Exceedances	Number of Detects	Number of Analyses ⁽³⁾	Value (Q)	Value (Q)	Value (Q)	Value (Q)	Value (Q)
Alpha-BHC	UG/KG	0	0%	110	0	0	178	9.6 U	9.7 U	9.7 U	9.7 U	9.7 U
Alpha-Chlordane	UG/KG	34	4%		0	7	178	9.6 U	9.7 U	9.7 U	9.7 U	9.7 U
Beta-BHC	UG/KG	2.4	1%	200	0	1	178	9.6 U	9.7 U	9.7 U	9.7 U	9.7 U
Delta-BHC	UG/KG	0	0%	300	0	0	178	9.6 U	9.7 U	9.7 U	9.7 U	9.7 U
Dieldrin	UG/KG	0	0%	44	0	0	178	19 U	19 U	19 U	19 U	19 U
Endosulfan I	UG/KG	16	1%	900	0	1	178	9.6 U	9.7 U	9.7 U	9.7 U	9.7 U
Endosulfan II	UG/KG	0	0%	900	0	0	178	19 U	19 U	19 U	19 U	19 U
Endosulfan sulfate	UG/KG	6.2	1%	1000	0	1	178	19 U	19 U	19 U	19 U	19 U
Endrin	UG/KG	16	2%	100	0	3	178	19 U	19 U	19 U	19 U	19 U
Endrin aldehyde	UG/KG	4.9	1%		0	2	178	19 U	19 U	19 U	19 U	19 U
Endrin ketone	UG/KG	38	2%		0	4	178	19 U	19 U	19 U	19 U	19 U
Gamma-BHC/Lindane	UG/KG	0	0%	60	0	0	178	9.6 U	9.7 U	9.7 U	9.7 U	9.7 U
Gamma-Chlordane	UG/KG	24	8%	540	0	14	178	9.6 U	9.7 U	9.7 U	9.7 U	9.7 U
Heptachlor	UG/KG	0	0%	100	0	0	178	9.6 U	9.7 U	9.7 U	9.7 U	9.7 U
Heptachlor epoxide	UG/KG	3	1%	20	0	2	178	9.6 U	9.7 U	9.7 U	9.7 U	9.7 U
Methoxychlor	UG/KG	0	0%		0	0	178	96 U	97 U	97 U	97 U	97 U
Toxaphene	UG/KG	0	0%		0	0	178	190 U	190 U	190 U	190 U	190 U
Aroclor-1016	UG/KG	0	0%		0	0	178	37 U	38 U	38 U	38 U	38 U
Aroclor-1221	UG/KG	0	0%		0	0	178	37 U	38 U	38 U	38 U	38 U
Aroclor-1232	UG/KG	0	0%		0	0	178	37 U	38 U	38 U	38 U	38 U
Aroclor-1242	UG/KG	0	0%		0	0	178	37 U	38 U	38 U	38 U	38 U
Aroclor-1248	UG/KG	0	0%		0	0	178	37 U	38 U	38 U	38 U	38 U
Aroclor-1254	UG/KG	0	0%	10000	0	0	178	37 U	38 U	38 U	38 U	38 U
Aroclor-1260	UG/KG	79	1%	10000	0	2	178	37 U	38 U	38 U	38 U	38 U
Metals												
Aluminum	MG/KG	18300	100%	19300	0	178	178	11600	10400	10700	11700	10700
Antimony	MG/KG	424	58%	5.9	5	104	178	3.3 UJ	3.3 UJ	3.4 UJ	3.4 UJ	3.3 UJ
Arsenic	MG/KG	32.2	100%	8.2	7	178	178	5.2	4.6	5.1	5.3	4.5
Barium	MG/KG	304	100%	300	1	178	178	98.7	90.4	84	107	93.3
Beryllium	MG/KG	2.6	99%	1.1	2	176	178	0.5	0.33	0.27	0.34	0.39
Cadmium	MG/KG	3.2	86%	2.3	2	153	178	0.28 U	0.28 U	0.3 J	0.28 U	0.28 U
Calcium	MG/KG	214000	100%	121000	1	178	178	33200	28800	42200	30700	55200
Chromium	MG/KG	39.3	100%	29.6	2	178	178	17.8	16.6	18	18.1	16.6
Cobalt	MG/KG	47.8	100%	30	2	178	178	7.5	7.8	9.5	8.4	7.7
Copper	MG/KG	305	100%	33	19	178	178	20.9	28	21.8	24.7	22.7
Cyanide	MG/KG	0	0%	0.35	0	0	9					
Iron	MG/KG	64000	100%	36500	1	178	178	22200 J	20200	23200	22300	20500
Lead	MG/KG	164	100%	24.8	75	178	178	21 J	20.5 J	20 J	24.4 J	17.7 J
Magnesium	MG/KG	30200	100%	21500	3	178	178	7880	6570	10200	7720	12200
Manganese	MG/KG	1290	100%	1060	3	178	178	315 J	360	375	327	366
Mercury	MG/KG	0.95	95%	0.1	37	169	178	0.07	0.06	0.06	0.09	0.05
Nickel	MG/KG	88.3	100%	49	3	178	178	25.2	25.7	28.9	26.2	25.3
Potassium	MG/KG	2290	100%	2380	0	178	178	1070	1060	1030	1020	964
Selenium	MG/KG	1.5	9%	2	0	16	178	0.56 U	0.55 U	0.57 U	0.56 U	0.56 U
Silver	MG/KG	2.9	49%	0.75	62	87	178	0.56 U	0.55 U	0.57 U	0.56 U	0.56 U

**Table A-2A
SURFACE SOIL SAMPLE RESULTS (0-2 ft.)
SEAD-59
SEAD-59 and SEAD-71 Phase II RI Report
Seneca Army Depot Activity**

Facility	SEAD-59	SEAD-59	SEAD-59	SEAD-59	SEAD-59
Location ID	WS-59-03-001-1	WS-59-03-001-2	WS-59-03-002-1	WS-59-03-002-2	WS-59-03-002-3
Matrix	SOIL	SOIL	SOIL	SOIL	SOIL
Sample ID	WS-59-03-001-1	WS-59-03-001-2	WS-59-03-002-1	WS-59-03-002-2	WS-59-03-002-3
Sample Depth to Top of Sample ⁽¹⁾	0	0	0	0	0
Sample Depth to Bottom of Sample ⁽¹⁾	0	0	0	0	0
Sample Date	5/6/2004	5/6/2004	5/6/2004	5/6/2004	5/6/2004
QC Code	SA	SA	SA	SA	SA
Study ID	ENSR IRM	ENSR IRM	ENSR IRM	ENSR IRM	ENSR IRM
Sample Round	1	1	1	1	1

Parameter	Units	Maximum Value	Frequency of Detection	NYSDEC TAGM 4046 ⁽²⁾	Number of Exceedances	Number of Detects	Number of Analyses ⁽³⁾	Value (Q)	Value (Q)	Value (Q)	Value (Q)	Value (Q)
Sodium	MG/KG	4060	99%	172	86	177	178	117	94	89.8	84.9	101
Thallium	MG/KG	1.8	29%	0.7	24	51	178	0.56 U	0.55 U	0.57 U	0.56 U	0.56 U
Vanadium	MG/KG	28.5	100%	150	0	178	178	19.8	17.3	18.8	19.6	17.8
Zinc	MG/KG	341	100%	110	19	178	178	79.4 J	83.7 J	97.5 J	85.6 J	76.3 J

Note(s):

- (1) - Historical sample depths are presented (I.e. prior to 2002 TCRA)
- (2) - NYSDEC Technical and Administrative Guidance Memorandum (TAGM) HWR-94-4046, Revised January 24, 1994
- (3) - Sample/Duplicate pair are presented as individual samples in this table. Statistical information used Sample Duplicate pairs as a single entity and averaged result values were used in risk assessment analysis.

U = compound was not detected

J = the reported value is an estimated concentration

UJ = the compound was not detected; the associated reporting limit is approximate

R = the data was rejected in the data validating process

NJ = compound was "tentatively identified" and the associated numerical value is approximate

Table A-2A
SURFACE SOIL SAMPLE RESULTS (0-2 ft.)
SEAD-59
SEAD-59 and SEAD-71 Phase II RI Report
Seneca Army Depot Activity

Facility	SEAD-59	SEAD-59	SEAD-59	SEAD-59	SEAD-59
Location ID	WS-59-03-002-4	WS-59-04-010-1	WS-59-04-010-10	WS-59-04-010-11	WS-59-04-010-3
Matrix	SOIL	SOIL	SOIL	SOIL	SOIL
Sample ID	WS-59-03-002-4	WS-59-04-010-1	WS-59-04-010-10	WS-59-04-010-11	WS-59-04-010-3
Sample Depth to Top of Sample ⁽¹⁾	0	0	0	0	0
Sample Depth to Bottom of Sample ⁽¹⁾	0	0	0	0	0
Sample Date	5/6/2004	5/6/2004	5/6/2004	5/6/2004	5/6/2004
QC Code	SA	SA	SA	SA	SA
Study ID	ENSR IRM	ENSR IRM	ENSR IRM	ENSR IRM	ENSR IRM
Sample Round	1	1	1	1	1

Parameter	Units	Maximum Value	Frequency of Detection	NYSDEC TAGM 4046 ⁽²⁾	Number of Exceedances	Number of Detects	Number of Analyses ⁽³⁾	Value (Q)	Value (Q)	Value (Q)	Value (Q)	Value (Q)
Volatile Organics												
1,1,1-Trichloroethane	UG/KG	0	0%	800	0	0	177	5.7 U	5 U	6 U	5 U	6 UJ
1,1,2,2-Tetrachloroethane	UG/KG	0	0%	600	0	0	169	5.7 U	5 UJ	6 UJ	5 U	6 R
1,1,2-Trichloro-1,2,2-Trifluoroethane	UG/KG	0	0%		0	0	168	5.7 U	5 UJ	6 UJ	5 UJ	6 UJ
1,1,2-Trichloroethane	UG/KG	0	0%		0	0	107		5 U	6 U	5 U	6 UJ
1,1-Dichloroethane	UG/KG	0	0%	200	0	0	177	5.7 U	5 U	6 U	5 U	6 UJ
1,1-Dichloroethene	UG/KG	8	2%	400	0	3	177	5.7 U	5 U	6 U	5 U	6 UJ
1,2,3-Trichloropropane	UG/KG	0	0%		0	0	70	5.7 U				
1,2,4-Trichlorobenzene	UG/KG	0	0%	3400	0	0	161	5.7 U	5 UJ	6 UJ	5 U	6 R
1,2-Dibromo-3-chloropropane	UG/KG	0	0%		0	0	91		5 UJ	6 UJ	5 U	6 R
1,2-Dibromoethane	UG/KG	0	0%		0	0	98		5 U	6 U	5 U	6 UJ
1,2-Dichlorobenzene	UG/KG	0	0%	7900	0	0	161	5.7 U	5 UJ	6 UJ	5 U	6 R
1,2-Dichloroethane	UG/KG	0	0%	100	0	0	177	5.7 U	5 U	6 U	5 U	6 UJ
1,2-Dichloroethene (total)	UG/KG	0	0%		0	0	9					
1,2-Dichloropropane	UG/KG	0	0%		0	0	107		5 U	6 U	5 U	6 UJ
1,3-Dichlorobenzene	UG/KG	0	0%	1600	0	0	161	5.7 U	5 UJ	6 UJ	5 U	6 R
1,3-Dichloropropane	UG/KG	0	0%		0	0	70	5.7 U				
1,4-Dichlorobenzene	UG/KG	0	0%	8500	0	0	161	5.7 U	5 UJ	6 UJ	5 U	6 R
Acetone	UG/KG	550	27%	200	2	47	177	23 U	5 U	6 U	5 U	6 UJ
Benzene	UG/KG	3	4%	60	0	7	177	5.7 U	5 U	6 U	5 U	6 UJ
Bromodichloromethane	UG/KG	0	0%		0	0	107		5 U	6 U	5 U	6 UJ
Bromoform	UG/KG	0	0%		0	0	107		5 U	6 U	5 U	6 UJ
Carbon disulfide	UG/KG	4	3%	2700	0	6	177	5.7 U	5 U	6 U	5 U	6 UJ
Carbon tetrachloride	UG/KG	0	0%	600	0	0	177	5.7 U	5 U	6 U	5 U	6 UJ
Chlorobenzene	UG/KG	0	0%	1700	0	0	177	5.7 U	5 U	6 U	5 U	6 UJ
Chlorodibromomethane	UG/KG	0	0%		0	0	177	5.7 U	5 U	6 U	5 U	6 UJ
Chloroethane	UG/KG	0	0%	1900	0	0	177	11 U	5 U	6 U	5 U	6 UJ
Chloroform	UG/KG	0	0%	300	0	0	177	5.7 U	5 U	6 U	5 U	6 UJ
Cis-1,2-Dichloroethene	UG/KG	0	0%		0	0	98		5 U	6 U	5 U	6 UJ
Cis-1,3-Dichloropropene	UG/KG	0	0%		0	0	107		5 U	6 U	5 U	6 UJ
Cyclohexane	UG/KG	3	8%		0	8	98		5 U	6 U	5 U	6 UJ
Dichlorodifluoromethane	UG/KG	0	0%		0	0	98		5 U	6 U	5 U	6 UJ
Ethyl benzene	UG/KG	4.6	1%	5500	0	2	177	5.7 U	5 U	6 U	5 U	6 UJ
Isopropylbenzene	UG/KG	0	0%		0	0	98		5 U	6 U	5 U	6 UJ
Meta/Para Xylene	UG/KG	9.4	4%		0	3	70	5.7 U				
Methyl Acetate	UG/KG	2	3%		0	3	98		5 U	6 U	5 U	6 UJ
Methyl Tertbutyl Ether	UG/KG	0	0%		0	0	98		5 U	6 U	5 U	6 UJ
Methyl bromide	UG/KG	0	0%		0	0	107		5 U	6 U	5 U	6 UJ
Methyl butyl ketone	UG/KG	0	0%		0	0	107		5 U	6 U	5 U	6 UJ
Methyl chloride	UG/KG	0	0%		0	0	107		5 U	6 U	5 U	6 UJ
Methyl cyclohexane	UG/KG	5	10%		0	10	98		5 U	6 U	5 U	6 UJ
Methyl ethyl ketone	UG/KG	190	12%	300	0	22	177	11 U	5 U	6 U	5 U	6 UJ
Methyl isobutyl ketone	UG/KG	1.9	1%	1000	0	1	177	11 U	5 U	6 U	5 U	6 UJ
Methylene chloride	UG/KG	4.9	20%	100	0	36	178	1.4 J	5 U	6 U	5 U	6 UJ
Ortho Xylene	UG/KG	5.05	4%		0	3	70	5.7 U				

**Table A-2A
SURFACE SOIL SAMPLE RESULTS (0-2 ft.)
SEAD-59
SEAD-59 and SEAD-71 Phase II RI Report
Seneca Army Depot Activity**

Facility	SEAD-59	SEAD-59	SEAD-59	SEAD-59	SEAD-59
Location ID	WS-59-03-002-4	WS-59-04-010-1	WS-59-04-010-10	WS-59-04-010-11	WS-59-04-010-3
Matrix	SOIL	SOIL	SOIL	SOIL	SOIL
Sample ID	WS-59-03-002-4	WS-59-04-010-1	WS-59-04-010-10	WS-59-04-010-11	WS-59-04-010-3
Sample Depth to Top of Sample ⁽¹⁾	0	0	0	0	0
Sample Depth to Bottom of Sample ⁽¹⁾	0	0	0	0	0
Sample Date	5/6/2004	5/6/2004	5/6/2004	5/6/2004	5/6/2004
QC Code	SA	SA	SA	SA	SA
Study ID	ENSR IRM	ENSR IRM	ENSR IRM	ENSR IRM	ENSR IRM
Sample Round	1	1	1	1	1

Parameter	Units	Maximum Value	Frequency of Detection	NYSDEC TAGM 4046 ⁽²⁾	Number of Exceedances	Number of Detects	Number of Analyses ⁽³⁾	Value (Q)	Value (Q)	Value (Q)	Value (Q)	Value (Q)
Styrene	UG/KG	0	0%		0	0	107		5 U	6 U	5 U	6 UJ
Tetrachloroethene	UG/KG	6.4	3%	1400	0	5	177	5.7 U	5 U	6 U	5 U	6 UJ
Toluene	UG/KG	8	8%	1500	0	14	177	5.7 U	5 U	6 U	5 U	6 UJ
Total BTEX	MG/KG	3.25	67%		0	2	3					
Total Xylenes	UG/KG	3	7%	1200	0	7	102		5 UJ	6 UJ	5 U	6 R
Trans-1,2-Dichloroethene	UG/KG	0	0%	300	0	0	168	5.7 U	5 U	6 U	5 U	6 UJ
Trans-1,3-Dichloropropene	UG/KG	0	0%		0	0	107		5 U	6 U	5 U	6 UJ
Trichloroethene	UG/KG	4.5	5%	700	0	8	177	5.7 U	5 U	6 U	5 U	6 UJ
Trichlorofluoromethane	UG/KG	6	1%		0	1	98		5 U	6 U	5 U	6 UJ
Vinyl chloride	UG/KG	0	0%	200	0	0	177	11 U	5 U	6 U	5 U	6 UJ
Semivolatile Organics												
1,1'-Biphenyl	UG/KG	254.5	2%		0	2	99		350 U	370 U	370 U	380 U
1,2,4-Trichlorobenzene	UG/KG	0	0%	3400	0	0	9					
1,2-Dichlorobenzene	UG/KG	0	0%	7900	0	0	9					
1,3-Dichlorobenzene	UG/KG	0	0%	1600	0	0	9					
1,4-Dichlorobenzene	UG/KG	0	0%	8500	0	0	9					
2,2'-oxybis(1-Chloropropane)	UG/KG	0	0%		0	0	105		350 U	370 U	370 U	380 U
2,4,5-Trichlorophenol	UG/KG	0	0%	100	0	0	178	380 U	890 U	940 U	920 U	950 U
2,4,6-Trichlorophenol	UG/KG	0	0%		0	0	178	380 U	350 U	370 U	370 U	380 U
2,4-Dichlorophenol	UG/KG	0	0%	400	0	0	178	380 U	350 U	370 U	370 U	380 U
2,4-Dimethylphenol	UG/KG	0	0%		0	0	108		350 U	370 U	370 U	380 U
2,4-Dinitrophenol	UG/KG	0	0%	200	0	0	178	1900 U	890 U	940 U	920 U	950 U
2,4-Dinitrotoluene	UG/KG	0	0%		0	0	178	380 U	350 U	370 U	370 U	380 U
2,6-Dinitrotoluene	UG/KG	0	0%	1000	0	0	178	380 U	350 U	370 U	370 U	380 U
2-Chloronaphthalene	UG/KG	0	0%		0	0	108		350 U	370 U	370 U	380 U
2-Chlorophenol	UG/KG	0	0%	800	0	0	178	380 U	350 U	370 U	370 U	380 U
2-Methylnaphthalene	UG/KG	1295	19%	36400	0	34	178	380 U	350 U	370 U	370 U	380 U
2-Methylphenol	UG/KG	0	0%	100	0	0	178	380 U	350 U	370 U	370 U	380 U
2-Nitroaniline	UG/KG	0	0%	430	0	0	178	1900 U	890 U	940 U	920 U	950 U
2-Nitrophenol	UG/KG	0	0%	330	0	0	178	380 U	350 U	370 U	370 U	380 U
3,3'-Dichlorobenzidine	UG/KG	0	0%		0	0	178	380 U	350 U	370 U	370 U	380 U
3-Nitroaniline	UG/KG	0	0%	500	0	0	178	1900 U	890 U	940 U	920 U	950 U
4,6-Dinitro-2-methylphenol	UG/KG	0	0%		0	0	108		890 U	940 U	920 U	950 U
4-Bromophenyl phenyl ether	UG/KG	0	0%		0	0	108		350 U	370 U	370 U	380 U
4-Chloro-3-methylphenol	UG/KG	0	0%	240	0	0	178	380 U	350 U	370 U	370 U	380 U
4-Chloroaniline	UG/KG	1200	1%	220	1	2	178	380 U	350 U	370 U	370 U	380 U
4-Chlorophenyl phenyl ether	UG/KG	0	0%		0	0	108		350 U	370 U	370 U	380 U
4-Methylphenol	UG/KG	150	3%	900	0	5	178	380 U	350 U	370 U	370 U	380 U
4-Nitroaniline	UG/KG	0	0%		0	0	108		890 U	940 U	920 U	950 U
4-Nitrophenol	UG/KG	0	0%	100	0	0	178	1900 U	890 U	940 U	920 U	950 U
Acenaphthene	UG/KG	2680	24%	50000	0	42	178	380 U	350 U	370 U	370 U	380 U
Acenaphthylene	UG/KG	1700	37%	41000	0	66	178	380 U	350 U	370 U	370 U	380 U
Acetophenone	UG/KG	0	0%		0	0	99		350 U	370 U	370 U	380 U
Aniline	UG/KG	0	0%		0	0	70	380 U				
Anthracene	UG/KG	4395	43%	50000	0	77	178	380 U	350 U	130 J	370 U	94 J

Table A-2A
SURFACE SOIL SAMPLE RESULTS (0-2 ft.)
SEAD-59
SEAD-59 and SEAD-71 Phase II RI Report
Seneca Army Depot Activity

Facility	SEAD-59	SEAD-59	SEAD-59	SEAD-59	SEAD-59
Location ID	WS-59-03-002-4	WS-59-04-010-1	WS-59-04-010-10	WS-59-04-010-11	WS-59-04-010-3
Matrix	SOIL	SOIL	SOIL	SOIL	SOIL
Sample ID	WS-59-03-002-4	WS-59-04-010-1	WS-59-04-010-10	WS-59-04-010-11	WS-59-04-010-3
Sample Depth to Top of Sample ⁽¹⁾	0	0	0	0	0
Sample Depth to Bottom of Sample ⁽¹⁾	0	0	0	0	0
Sample Date	5/6/2004	5/6/2004	5/6/2004	5/6/2004	5/6/2004
QC Code	SA	SA	SA	SA	SA
Study ID	ENSR IRM	ENSR IRM	ENSR IRM	ENSR IRM	ENSR IRM
Sample Round	1	1	1	1	1

Parameter	Units	Maximum Value	Frequency of Detection	NYSDEC TAGM 4046 ⁽²⁾	Number of Exceedances	Number of Detects	Number of Analyses ⁽³⁾	Value (Q)	Value (Q)	Value (Q)	Value (Q)	Value (Q)
Atrazine	UG/KG	120	1%		0	1	99		350 U	370 U	370 U	380 U
Benzaldehyde	UG/KG	50	1%		0	1	99		350 U	370 U	370 U	380 U
Benzo(a)anthracene	UG/KG	8900	51%	224	72	90	178	380 U	70 J	130 J	370 U	77 J
Benzo(a)pyrene	UG/KG	8050	51%	61	84	91	178	41 J	75 J	140 J	370 U	78 J
Benzo(b)fluoranthene	UG/KG	6800	52%	1100	40	92	178	41 J	97 J	200 J	370 U	100 J
Benzo(ghi)perylene	UG/KG	5200	46%	50000	0	82	178	380 U	43 J	96 J	370 U	42 J
Benzo(k)fluoranthene	UG/KG	7350	49%	1100	35	88	178	380 U	43 J	72 J	370 U	40 J
Benzoic Acid	UG/KG	0	0%	2700	0	0	70	1900 U				
Bis(2-Chloroethoxy)methane	UG/KG	0	0%		0	0	108		350 U	370 U	370 U	380 U
Bis(2-Chloroethyl)ether	UG/KG	0	0%		0	0	108		350 U	370 U	370 U	380 U
Bis(2-Chloroisopropyl)ether	UG/KG	0	0%		0	0	3					
Bis(2-Ethylhexyl)phthalate	UG/KG	990	19%	50000	0	34	178	380 U	350 U	52 J	370 U	42 J
Butylbenzylphthalate	UG/KG	0	0%	50000	0	0	178	380 U	350 U	370 U	370 U	380 U
Caprolactam	UG/KG	0	0%		0	0	99		350 U	370 U	370 U	380 U
Carbazole	UG/KG	755	19%		0	20	108		350 U	370 U	370 U	380 U
Chrysene	UG/KG	8900	51%	400	62	91	178	46 J	76 J	150 J	370 U	82 J
Di-n-butylphthalate	UG/KG	965	2%	8100	0	4	178	380 U	350 U	370 U	370 U	380 U
Di-n-octylphthalate	UG/KG	0	0%	50000	0	0	178	380 U	350 U	370 U	370 U	380 U
Dibenz(a,h)anthracene	UG/KG	1665	38%	14	67	68	178	380 U	350 U	370 U	370 U	380 U
Dibenzofuran	UG/KG	2350	16%	6200	0	28	178	380 U	350 U	370 U	370 U	380 U
Diethyl phthalate	UG/KG	10	1%	7100	0	1	178	380 U	350 U	370 U	370 U	380 U
Dimethylphthalate	UG/KG	0	0%	2000	0	0	178	380 U	350 U	370 U	370 U	380 U
Fluoranthene	UG/KG	23500	54%	50000	0	97	178	70 J	160 J	250 J	43 J	170 J
Fluorene	UG/KG	2640	28%	50000	0	49	178	380 U	350 U	370 U	370 U	380 U
Hexachlorobenzene	UG/KG	0	0%	410	0	0	178	380 U	350 U	370 U	370 U	380 U
Hexachlorobutadiene	UG/KG	0	0%		0	0	178	380 U	350 U	370 U	370 U	380 U
Hexachlorocyclopentadiene	UG/KG	0	0%		0	0	108		350 U	370 U	370 U	380 U
Hexachloroethane	UG/KG	0	0%		0	0	178	380 U	350 U	370 U	370 U	380 U
Indeno(1,2,3-cd)pyrene	UG/KG	4950	47%	3200	2	84	178	380 U	45 J	93 J	370 U	47 J
Isophorone	UG/KG	0	0%	4400	0	0	178	380 U	350 U	370 U	370 U	380 U
N-Nitrosodiphenylamine	UG/KG	100	1%		0	1	108		350 U	370 U	370 U	380 U
N-Nitrosodipropylamine	UG/KG	0	0%		0	0	108		350 U	370 U	370 U	380 U
Naphthalene	UG/KG	1800	19%	13000	0	34	178	380 U	350 U	370 U	370 U	380 U
Nitrobenzene	UG/KG	0	0%	200	0	0	178	380 U	350 U	370 U	370 U	380 U
Pentachlorophenol	UG/KG	0	0%	1000	0	0	178	1900 U	890 U	940 U	920 U	950 U
Phenanthrene	UG/KG	21300	51%	50000	0	90	178	380 U	82 J	130 J	370 U	95 J
Phenol	UG/KG	0	0%	30	0	0	178	380 U	350 U	370 U	370 U	380 U
Pyrene	UG/KG	19200	55%	50000	0	98	178	60 J	130 J	260 J	42 J	140 J
Pyridine	UG/KG	0	0%		0	0	100	1900 U				
Total Unknown PAHs as SV	MG/KG	25	100%		0	3	3					
Pesticides/PCBs												
4,4'-DDD	UG/KG	740	28%	2900	0	49	178	19 U	13	26 J	3.6 U	2.5 J
4,4'-DDE	UG/KG	2600	37%	2100	1	65	178	19 U	12 J	52 J	3.6 U	3.1 J
4,4'-DDT	UG/KG	3700	33%	2100	1	59	178	19 U	12	70 J	3.6 U	2.4 J
Aldrin	UG/KG	1.2	1%	41	0	1	178	9.7 U	1.8 U	3.9 U	1.8 U	1.9 U

**Table A-2A
SURFACE SOIL SAMPLE RESULTS (0-2 ft.)
SEAD-59
SEAD-59 and SEAD-71 Phase II RI Report
Seneca Army Depot Activity**

Facility	SEAD-59	SEAD-59	SEAD-59	SEAD-59	SEAD-59							
Location ID	WS-59-03-002-4	WS-59-04-010-1	WS-59-04-010-10	WS-59-04-010-11	WS-59-04-010-3							
Matrix	SOIL	SOIL	SOIL	SOIL	SOIL							
Sample ID	WS-59-03-002-4	WS-59-04-010-1	WS-59-04-010-10	WS-59-04-010-11	WS-59-04-010-3							
Sample Depth to Top of Sample ⁽¹⁾	0	0	0	0	0							
Sample Depth to Bottom of Sample ⁽¹⁾	0	0	0	0	0							
Sample Date	5/6/2004	5/6/2004	5/6/2004	5/6/2004	5/6/2004							
QC Code	SA	SA	SA	SA	SA							
Study ID	ENSR IRM	ENSR IRM	ENSR IRM	ENSR IRM	ENSR IRM							
Sample Round	1	1	1	1	1							
Parameter	Units	Maximum Value	Frequency of Detection	NYSDEC TAGM 4046 ⁽²⁾	Number of Exceedances	Number of Detects	Number of Analyses ⁽³⁾	Value (Q)	Value (Q)	Value (Q)	Value (Q)	Value (Q)
Alpha-BHC	UG/KG	0	0%	110	0	0	178	9.7 U	1.8 U	3.9 U	1.8 U	1.9 U
Alpha-Chlordane	UG/KG	34	4%		0	7	178	9.7 U	20 J	34 J	1.8 U	3.4 J
Beta-BHC	UG/KG	2.4	1%	200	0	1	178	9.7 U	1.8 U	3.9 U	1.8 U	1.9 U
Delta-BHC	UG/KG	0	0%	300	0	0	178	9.7 U	1.8 U	3.9 U	1.8 U	1.9 U
Dieldrin	UG/KG	0	0%	44	0	0	178	19 U	3.6 U	7.5 U	3.6 U	3.8 U
Endosulfan I	UG/KG	16	1%	900	0	1	178	9.7 U	1.8 U	3.9 U	1.8 U	1.9 U
Endosulfan II	UG/KG	0	0%	900	0	0	178	19 U	3.6 U	7.5 U	3.6 U	3.8 U
Endosulfan sulfate	UG/KG	6.2	1%	1000	0	1	178	19 U	3.6 U	7.5 U	3.6 U	3.8 U
Endrin	UG/KG	16	2%	100	0	3	178	19 U	3.6 U	7.5 U	3.6 U	3.8 U
Endrin aldehyde	UG/KG	4.9	1%		0	2	178	19 U	3.6 U	7.5 U	3.6 U	3.8 U
Endrin ketone	UG/KG	38	2%		0	4	178	19 U	3.6 U	7.5 U	3.6 U	3.8 U
Gamma-BHC/Lindane	UG/KG	0	0%	60	0	0	178	9.7 U	1.8 U	3.9 U	1.8 U	1.9 U
Gamma-Chlordane	UG/KG	24	8%	540	0	14	178	9.7 U	18	24 J	1.8 U	3.6 J
Heptachlor	UG/KG	0	0%	100	0	0	178	9.7 U	1.8 U	3.9 UJ	1.8 U	1.9 U
Heptachlor epoxide	UG/KG	3	1%	20	0	2	178	9.7 U	1.8 U	3.9 U	1.8 U	1.9 U
Methoxychlor	UG/KG	0	0%		0	0	178	97 U	18 U	39 U	18 UJ	19 U
Toxaphene	UG/KG	0	0%		0	0	178	190 U	180 U	390 U	180 U	190 U
Aroclor-1016	UG/KG	0	0%		0	0	178	38 U	36 U	38 U	36 U	38 U
Aroclor-1221	UG/KG	0	0%		0	0	178	38 U	36 U	38 U	36 U	38 U
Aroclor-1232	UG/KG	0	0%		0	0	178	38 U	36 U	38 U	36 U	38 U
Aroclor-1242	UG/KG	0	0%		0	0	178	38 U	36 U	38 U	36 U	38 U
Aroclor-1248	UG/KG	0	0%		0	0	178	38 U	36 U	38 U	36 U	38 U
Aroclor-1254	UG/KG	0	0%	10000	0	0	178	38 U	36 U	38 U	36 U	38 U
Aroclor-1260	UG/KG	79	1%	10000	0	2	178	38 U	36 U	38 U	36 U	38 U
Metals												
Aluminum	MG/KG	18300	100%	19300	0	178	178	11200	13100 J	12200 J	7740 J	10500 J
Antimony	MG/KG	424	58%	5.9	5	104	178	3.4 UJ	1.9 J	1.3 J	1.2 J	1.5 J
Arsenic	MG/KG	32.2	100%	8.2	7	178	178	4.6	5.5 J	6.1 J	4.8 J	5.6 J
Barium	MG/KG	304	100%	300	1	178	178	101	83.1 J	99.7 J	57.9 J	74.7 J
Beryllium	MG/KG	2.6	99%	1.1	2	176	178	0.43	0.61	0.6	0.39	0.5
Cadmium	MG/KG	3.2	86%	2.3	2	153	178	0.31 J	0.29 J	0.55	0.24 J	0.33
Calcium	MG/KG	214000	100%	121000	1	178	178	63400	9880	31600 J	67000	51900
Chromium	MG/KG	39.3	100%	29.6	2	178	178	17.5	20.7 J	18.5 J	11.5 J	15.5 J
Cobalt	MG/KG	47.8	100%	30	2	178	178	8.2	7.7 J	8.1 J	8.7 J	7.7 J
Copper	MG/KG	305	100%	33	19	178	178	23	25.3 J	33.6 J	20.1 J	23.2 J
Cyanide	MG/KG	0	0%	0.35	0	0	9					
Iron	MG/KG	64000	100%	36500	1	178	178	21100	22100	20700	16500	19000
Lead	MG/KG	164	100%	24.8	75	178	178	24.4 J	16.5 J	39 J	9 J	12.7 J
Magnesium	MG/KG	30200	100%	21500	3	178	178	12100	5240 J	7630 J	12000 J	12800 J
Manganese	MG/KG	1290	100%	1060	3	178	178	464	307 J	459 J	455 J	504 J
Mercury	MG/KG	0.95	95%	0.1	37	169	178	0.06	0.23 J	0.29 J	0.06	0.14
Nickel	MG/KG	88.3	100%	49	3	178	178	26.8	29.7 J	24.8 J	21 J	25 J
Potassium	MG/KG	2290	100%	2380	0	178	178	1100	1460 J	1570 J	1070 J	1390 J
Selenium	MG/KG	1.5	9%	2	0	16	178	0.56 U	0.44 U	0.41 U	0.37 U	0.44 U
Silver	MG/KG	2.9	49%	0.75	62	87	178	0.56 U	2.3	2.8	0.29 J	0.94

**Table A-2A
SURFACE SOIL SAMPLE RESULTS (0-2 ft.)
SEAD-59
SEAD-59 and SEAD-71 Phase II RI Report
Seneca Army Depot Activity**

Facility	SEAD-59	SEAD-59	SEAD-59	SEAD-59	SEAD-59
Location ID	WS-59-03-002-4	WS-59-04-010-1	WS-59-04-010-10	WS-59-04-010-11	WS-59-04-010-3
Matrix	SOIL	SOIL	SOIL	SOIL	SOIL
Sample ID	WS-59-03-002-4	WS-59-04-010-1	WS-59-04-010-10	WS-59-04-010-11	WS-59-04-010-3
Sample Depth to Top of Sample ⁽¹⁾	0	0	0	0	0
Sample Depth to Bottom of Sample ⁽¹⁾	0	0	0	0	0
Sample Date	5/6/2004	5/6/2004	5/6/2004	5/6/2004	5/6/2004
QC Code	SA	SA	SA	SA	SA
Study ID	ENSR IRM	ENSR IRM	ENSR IRM	ENSR IRM	ENSR IRM
Sample Round	1	1	1	1	1

Parameter	Units	Maximum Value	Frequency of Detection	NYSDEC TAGM 4046 ⁽²⁾	Number of Exceedances	Number of Detects	Number of Analyses ⁽³⁾	Value (Q)	Value (Q)	Value (Q)	Value (Q)	Value (Q)
Sodium	MG/KG	4060	99%	172	86	177	178	323	118 J	104 J	145 J	132 J
Thallium	MG/KG	1.8	29%	0.7	24	51	178	0.56 U	0.22 U	0.21 U	0.18 U	0.22 U
Vanadium	MG/KG	28.5	100%	150	0	178	178	19.5	20.4 J	21.3 J	12.8 J	17.7 J
Zinc	MG/KG	341	100%	110	19	178	178	70.3 J	83.5 J	92.7 J	47.8 J	60.7 J

Note(s):

- (1) - Historical sample depths are presented (I.e. prior to 2002 TCRA)
- (2) - NYSDEC Technical and Administrative Guidance Memorandum (TAGM) HWR-94-4046, Revised January 24, 1994
- (3) - Sample/Duplicate pair are presented as individual samples in this table. Statistical information used Sample Duplicate pairs as a single entity and averaged result values were used in risk assessment analysis.

U = compound was not detected

J = the reported value is an estimated concentration

UJ = the compound was not detected; the associated reporting limit is approximate

R = the data was rejected in the data validating process

NJ = compound was "tentatively identified" and the associated numerical value is approximate

**Table A-2A
SURFACE SOIL SAMPLE RESULTS (0-2 ft.)
SEAD-59
SEAD-59 and SEAD-71 Phase II RI Report
Seneca Army Depot Activity**

Facility	SEAD-59	SEAD-59	SEAD-59	SEAD-59	SEAD-59
Location ID	WS-59-04-010-5	WS-59-04-010-6	WS-59-04-010-7	WS-59-04-010-9	WS-59-OTHERC-001-1
Maxitrix	SOIL	SOIL	SOIL	SOIL	SOIL
Sample ID	WS-59-04-010-5	WS-59-04-010-6	WS-59-04-010-7	WS-59-04-010-9	WS-59-OTHERC-001-1
Sample Depth to Top of Sample ⁽¹⁾	0	0	0	0	0
Sample Depth to Bottom of Sample ⁽¹⁾	0	0	0	0	0
Sample Date	5/6/2004	5/6/2004	5/6/2004	5/6/2004	5/6/2004
QC Code	SA	SA	SA	SA	SA
Study ID	ENSR IRM	ENSR IRM	ENSR IRM	ENSR IRM	ENSR IRM
Sample Round	1	1	1	1	1

Parameter	Units	Maximum Value	Frequency of Detection	NYSDEC TAGM 4046 ⁽²⁾	Number of Exceedances	Number of Detects	Number of Analyses ⁽³⁾	Value (Q)	Value (Q)	Value (Q)	Value (Q)	Value (Q)
Volatile Organics												
1,1,1-Trichloroethane	UG/KG	0	0%	800	0	0	177	6 U	5 U	5 U	6 U	5.7 U
1,1,2,2-Tetrachloroethane	UG/KG	0	0%	600	0	0	169	6 UJ	5 R	5 R	6 U	5.7 U
1,1,2-Trichloro-1,2,2-Trifluoroethane	UG/KG	0	0%		0	0	168	6 U	5 U	5 U	6 UJ	5.7 U
1,1,2-Trichloroethane	UG/KG	0	0%		0	0	107	6 U	5 U	5 U	6 U	
1,1-Dichloroethane	UG/KG	0	0%	200	0	0	177	6 U	5 U	5 U	6 U	5.7 U
1,1-Dichloroethene	UG/KG	8	2%	400	0	3	177	6 U	5 U	5 U	6 U	5.7 U
1,2,3-Trichloropropane	UG/KG	0	0%		0	0	70					5.7 U
1,2,4-Trichlorobenzene	UG/KG	0	0%	3400	0	0	161	6 UJ	5 R	5 R	6 U	5.7 U
1,2-Dibromo-3-chloropropane	UG/KG	0	0%		0	0	91	6 UJ	5 R	5 R	6 U	
1,2-Dibromoethane	UG/KG	0	0%		0	0	98	6 UJ	5 UJ	5 UJ	6 U	
1,2-Dichlorobenzene	UG/KG	0	0%	7900	0	0	161	6 UJ	5 R	5 R	6 U	5.7 U
1,2-Dichloroethane	UG/KG	0	0%	100	0	0	177	6 U	5 U	5 U	6 U	5.7 U
1,2-Dichloroethene (total)	UG/KG	0	0%		0	0	9					
1,2-Dichloropropane	UG/KG	0	0%		0	0	107	6 U	5 U	5 U	6 U	
1,3-Dichlorobenzene	UG/KG	0	0%	1600	0	0	161	6 UJ	5 R	5 R	6 U	5.7 U
1,3-Dichloropropane	UG/KG	0	0%		0	0	70					5.7 U
1,4-Dichlorobenzene	UG/KG	0	0%	8500	0	0	161	6 UJ	5 R	5 R	6 U	5.7 U
Acetone	UG/KG	550	27%	200	2	47	177	6 U	5 U	5 U	6 U	23 U
Benzene	UG/KG	3	4%	60	0	7	177	1 J	5 U	1 J	6 U	5.7 U
Bromodichloromethane	UG/KG	0	0%		0	0	107	6 U	5 U	5 U	6 U	
Bromoform	UG/KG	0	0%		0	0	107	6 UJ	5 UJ	5 UJ	6 U	
Carbon disulfide	UG/KG	4	3%	2700	0	6	177	1 J	5 U	3 J	6 U	5.7 U
Carbon tetrachloride	UG/KG	0	0%	600	0	0	177	6 U	5 UJ	5 U	6 U	5.7 U
Chlorobenzene	UG/KG	0	0%	1700	0	0	177	6 UJ	5 UJ	5 UJ	6 U	5.7 U
Chlorodibromomethane	UG/KG	0	0%		0	0	177	6 UJ	5 UJ	5 UJ	6 U	5.7 U
Chloroethane	UG/KG	0	0%	1900	0	0	177	6 U	5 U	5 U	6 U	11 U
Chloroform	UG/KG	0	0%	300	0	0	177	6 U	5 U	5 U	6 U	5.7 U
Cis-1,2-Dichloroethene	UG/KG	0	0%		0	0	98	6 U	5 U	5 U	6 U	
Cis-1,3-Dichloropropene	UG/KG	0	0%		0	0	107	6 U	5 U	5 U	6 U	
Cyclohexane	UG/KG	3	8%		0	8	98	3 J	5 U	3 J	6 U	
Dichlorodifluoromethane	UG/KG	0	0%		0	0	98	6 U	5 U	5 U	6 U	
Ethyl benzene	UG/KG	4.6	1%	5500	0	2	177	6 UJ	5 UJ	5 UJ	6 U	5.7 U
Isopropylbenzene	UG/KG	0	0%		0	0	98	6 UJ	5 UJ	5 UJ	6 U	
Meta/Para Xylene	UG/KG	9.4	4%		0	3	70					5.7 U
Methyl Acetate	UG/KG	2	3%		0	3	98	6 U	5 U	5 U	6 U	
Methyl Tertbutyl Ether	UG/KG	0	0%		0	0	98	6 U	5 U	5 U	6 U	
Methyl bromide	UG/KG	0	0%		0	0	107	6 U	5 U	5 U	6 U	
Methyl butyl ketone	UG/KG	0	0%		0	0	107	6 UJ	5 UJ	5 UJ	6 U	
Methyl chloride	UG/KG	0	0%		0	0	107	6 U	5 U	5 U	6 U	
Methyl cyclohexane	UG/KG	5	10%		0	10	98	5 J	5 U	4 J	6 U	
Methyl ethyl ketone	UG/KG	190	12%	300	0	22	177	6 U	5 UJ	5 U	6 U	11 U
Methyl isobutyl ketone	UG/KG	1.9	1%	1000	0	1	177	6 U	5 UJ	5 U	6 U	11 U
Methylene chloride	UG/KG	4.9	20%	100	0	36	178	6 U	4 J	5 U	6 U	5.7 U
Ortho Xylene	UG/KG	5.05	4%		0	3	70					5.7 U

**Table A-2A
SURFACE SOIL SAMPLE RESULTS (0-2 ft.)
SEAD-59
SEAD-59 and SEAD-71 Phase II RI Report
Seneca Army Depot Activity**

Facility	SEAD-59	SEAD-59	SEAD-59	SEAD-59	SEAD-59
Location ID	WS-59-04-010-5	WS-59-04-010-6	WS-59-04-010-7	WS-59-04-010-9	WS-59-OTHERC-001-1
Maxtrix	SOIL	SOIL	SOIL	SOIL	SOIL
Sample ID	WS-59-04-010-5	WS-59-04-010-6	WS-59-04-010-7	WS-59-04-010-9	WS-59-OTHERC-001-1
Sample Depth to Top of Sample ⁽¹⁾	0	0	0	0	0
Sample Depth to Bottom of Sample ⁽¹⁾	0	0	0	0	0
Sample Date	5/6/2004	5/6/2004	5/6/2004	5/6/2004	5/6/2004
QC Code	SA	SA	SA	SA	SA
Study ID	ENSR IRM	ENSR IRM	ENSR IRM	ENSR IRM	ENSR IRM
Sample Round	1	1	1	1	1

Parameter	Units	Maximum	Frequency of	NYSDEC	Number of	Number of	Number of	Value (Q)	Value (Q)	Value (Q)	Value (Q)	Value (Q)
		Value	Detection	TAGM 4046 ⁽²⁾	Exceedances	Detects	Analyses ⁽³⁾					
Styrene	UG/KG	0	0%		0	0	107	6 UJ	5 UJ	5 UJ	6 U	
Tetrachloroethene	UG/KG	6.4	3%	1400	0	5	177	6 UJ	5 UJ	5 UJ	6 U	5.7 U
Toluene	UG/KG	8	8%	1500	0	14	177	8	5 U	4 J	6 U	5.7 U
Total BTEX	MG/KG	3.25	67%		0	2	3					
Total Xylenes	UG/KG	3	7%	1200	0	7	102	2 J	5 R	1 J	6 U	
Trans-1,2-Dichloroethene	UG/KG	0	0%	300	0	0	168	6 U	5 U	5 U	6 U	5.7 U
Trans-1,3-Dichloropropene	UG/KG	0	0%		0	0	107	6 U	5 U	5 U	6 U	
Trichloroethene	UG/KG	4.5	5%	700	0	8	177	6 U	5 U	5 U	6 U	5.7 U
Trichlorofluoromethane	UG/KG	6	1%		0	1	98	6 U	6 J	5 U	6 U	
Vinyl chloride	UG/KG	0	0%	200	0	0	177	6 U	5 U	5 U	6 U	11 U
Semivolatle Organics												
1,1'-Biphenyl	UG/KG	254.5	2%		0	2	99	750 U	370 U	370 U	370 U	
1,2,4-Trichlorobenzene	UG/KG	0	0%	3400	0	0	9					
1,2-Dichlorobenzene	UG/KG	0	0%	7900	0	0	9					
1,3-Dichlorobenzene	UG/KG	0	0%	1600	0	0	9					
1,4-Dichlorobenzene	UG/KG	0	0%	8500	0	0	9					
2,2'-oxybis(1-Chloropropane)	UG/KG	0	0%		0	0	105	750 U	370 U	370 U	370 U	
2,4,5-Trichlorophenol	UG/KG	0	0%	100	0	0	178	1900 U	920 U	940 U	920 U	380 U
2,4,6-Trichlorophenol	UG/KG	0	0%		0	0	178	750 U	370 U	370 U	370 U	380 U
2,4-Dichlorophenol	UG/KG	0	0%	400	0	0	178	750 U	370 U	370 U	370 U	380 U
2,4-Dimethylphenol	UG/KG	0	0%		0	0	108	750 U	370 U	370 U	370 U	
2,4-Dinitrophenol	UG/KG	0	0%	200	0	0	178	1900 U	920 UJ	940 UJ	920 U	1900 U
2,4-Dinitrotoluene	UG/KG	0	0%		0	0	178	750 U	370 U	370 U	370 U	380 U
2,6-Dinitrotoluene	UG/KG	0	0%	1000	0	0	178	750 U	370 U	370 U	370 U	380 U
2-Chloronaphthalene	UG/KG	0	0%		0	0	108	750 U	370 U	370 U	370 U	
2-Chlorophenol	UG/KG	0	0%	800	0	0	178	750 U	370 U	370 U	370 U	380 U
2-Methylnaphthalene	UG/KG	1295	19%	36400	0	34	178	150 J	65 J	370 U	370 U	380 U
2-Methylphenol	UG/KG	0	0%	100	0	0	178	750 U	370 U	370 U	370 U	380 U
2-Nitroaniline	UG/KG	0	0%	430	0	0	178	1900 U	920 U	940 U	920 U	1900 U
2-Nitrophenol	UG/KG	0	0%	330	0	0	178	750 U	370 U	370 U	370 U	380 U
3,3'-Dichlorobenzidine	UG/KG	0	0%		0	0	178	750 U	370 U	370 U	370 U	380 U
3-Nitroaniline	UG/KG	0	0%	500	0	0	178	1900 U	920 U	940 U	920 U	1900 U
4,6-Dinitro-2-methylphenol	UG/KG	0	0%		0	0	108	1900 U	920 UJ	940 UJ	920 U	
4-Bromophenyl phenyl ether	UG/KG	0	0%		0	0	108	750 U	370 U	370 U	370 U	
4-Chloro-3-methylphenol	UG/KG	0	0%	240	0	0	178	750 U	370 U	370 U	370 U	380 U
4-Chloroaniline	UG/KG	1200	1%	220	1	2	178	750 U	370 U	370 U	370 U	380 U
4-Chlorophenyl phenyl ether	UG/KG	0	0%		0	0	108	750 U	370 U	370 U	370 U	
4-Methylphenol	UG/KG	150	3%	900	0	5	178	750 U	370 U	370 U	370 U	380 U
4-Nitroaniline	UG/KG	0	0%		0	0	108	1900 U	920 U	940 U	920 U	
4-Nitrophenol	UG/KG	0	0%	100	0	0	178	1900 U	920 U	940 U	920 U	1900 U
Acenaphthene	UG/KG	2680	24%	50000	0	42	178	610 J	290 J	60 J	65 J	380 U
Acenaphthylene	UG/KG	1700	37%	41000	0	66	178	750 U	37 J	370 U	370 U	380 U
Acetophenone	UG/KG	0	0%		0	0	99	750 U	370 U	370 U	370 U	
Aniline	UG/KG	0	0%		0	0	70					380 U
Anthracene	UG/KG	4395	43%	50000	0	77	178	1200	570	130 J	180 J	380 U

**Table A-2A
SURFACE SOIL SAMPLE RESULTS (0-2 ft.)
SEAD-59
SEAD-59 and SEAD-71 Phase II RI Report
Seneca Army Depot Activity**

Facility	SEAD-59	SEAD-59	SEAD-59	SEAD-59	SEAD-59
Location ID	WS-59-04-010-5	WS-59-04-010-6	WS-59-04-010-7	WS-59-04-010-9	WS-59-OTHERC-001-1
Maxtrix	SOIL	SOIL	SOIL	SOIL	SOIL
Sample ID	WS-59-04-010-5	WS-59-04-010-6	WS-59-04-010-7	WS-59-04-010-9	WS-59-OTHERC-001-1
Sample Depth to Top of Sample ⁽¹⁾	0	0	0	0	0
Sample Depth to Bottom of Sample ⁽¹⁾	0	0	0	0	0
Sample Date	5/6/2004	5/6/2004	5/6/2004	5/6/2004	5/6/2004
QC Code	SA	SA	SA	SA	SA
Study ID	ENSR IRM	ENSR IRM	ENSR IRM	ENSR IRM	ENSR IRM
Sample Round	1	1	1	1	1

Parameter	Units	Maximum	Frequency of	NYSDEC	Number of	Number of	Number of	Value (Q)	Value (Q)	Value (Q)	Value (Q)	Value (Q)
		Value	Detection	TAGM 4046 ⁽²⁾	Exceedances	Detects	Analyses ⁽³⁾					
Atrazine	UG/KG	120	1%		0	1	99	750 U	370 U	370 U	370 U	
Benzaldehyde	UG/KG	50	1%		0	1	99	750 U	370 U	370 U	370 U	
Benzo(a)anthracene	UG/KG	8900	51%	224	72	90	178	2000	1300	360 J	690	66 J
Benzo(a)pyrene	UG/KG	8050	51%	61	84	91	178	1800	1200	330 J	660	380 U
Benzo(b)fluoranthene	UG/KG	6800	52%	1100	40	92	178	2100	1400	400	830	66 J
Benzo(ghi)perylene	UG/KG	5200	46%	50000	0	82	178	850	600	190 J	330 J	380 U
Benzo(k)fluoranthene	UG/KG	7350	49%	1100	35	88	178	920	530	170 J	340 J	76 J
Benzoic Acid	UG/KG	0	0%	2700	0	0	70					1900 U
Bis(2-Chloroethoxy)methane	UG/KG	0	0%		0	0	108	750 U	370 U	370 U	370 U	
Bis(2-Chloroethyl)ether	UG/KG	0	0%		0	0	108	750 U	370 U	370 U	370 U	
Bis(2-Chloroisopropyl)ether	UG/KG	0	0%		0	0	3					
Bis(2-Ethylhexyl)phthalate	UG/KG	990	19%	50000	0	34	178	750 U	58 NJ	39 NJ	65 J	380 U
Butylbenzylphthalate	UG/KG	0	0%	50000	0	0	178	750 U	370 U	370 U	370 U	380 U
Caprolactam	UG/KG	0	0%		0	0	99	750 U	370 U	370 U	370 U	
Carbazole	UG/KG	755	19%		0	20	108	690 J	330 J	78 J	93 J	
Chrysene	UG/KG	8900	51%	400	62	91	178	1900	1200 NJ	330 J	620	86 J
Di-n-butylphthalate	UG/KG	965	2%	8100	0	4	178	750 U	370 U	370 U	370 U	380 U
Di-n-octylphthalate	UG/KG	0	0%	50000	0	0	178	750 U	370 U	370 U	370 U	380 U
Dibenz(a,h)anthracene	UG/KG	1665	38%	14	67	68	178	270 J	190 J	56 J	94 J	380 U
Dibenzofuran	UG/KG	2350	16%	6200	0	28	178	410 J	170 J	370 U	370 U	380 U
Diethyl phthalate	UG/KG	10	1%	7100	0	1	178	750 U	370 U	370 U	370 U	380 U
Dimethylphthalate	UG/KG	0	0%	2000	0	0	178	750 U	370 U	370 U	370 U	380 U
Fluoranthene	UG/KG	23500	54%	50000	0	97	178	4400	2300	670	1200	110 J
Fluorene	UG/KG	2640	28%	50000	0	49	178	600 J	280 J	55 J	64 J	380 U
Hexachlorobenzene	UG/KG	0	0%	410	0	0	178	750 U	370 U	370 U	370 U	380 U
Hexachlorobutadiene	UG/KG	0	0%		0	0	178	750 U	370 U	370 U	370 U	380 U
Hexachlorocyclopentadiene	UG/KG	0	0%		0	0	108	750 U	370 U	370 U	370 U	
Hexachloroethane	UG/KG	0	0%		0	0	178	750 U	370 U	370 U	370 U	380 U
Indeno(1,2,3-cd)pyrene	UG/KG	4950	47%	3200	2	84	178	970	690	200 J	380	40 J
Isophorone	UG/KG	0	0%	4400	0	0	178	750 U	370 U	370 U	370 U	380 U
N-Nitrosodiphenylamine	UG/KG	100	1%		0	1	108	750 U	370 U	370 U	370 U	
N-Nitrosodipropylamine	UG/KG	0	0%		0	0	108	750 U	370 UJ	370 UJ	370 U	
Naphthalene	UG/KG	1800	19%	13000	0	34	178	430 J	180 J	370 U	370 U	380 U
Nitrobenzene	UG/KG	0	0%	200	0	0	178	750 UJ	370 U	370 U	370 U	380 U
Pentachlorophenol	UG/KG	0	0%	1000	0	0	178	1900 U	920 U	940 U	920 U	1900 U
Phenanthrene	UG/KG	21300	51%	50000	0	90	178	4400	1900	450	610	380 U
Phenol	UG/KG	0	0%	30	0	0	178	750 U	370 U	370 U	370 U	380 U
Pyrene	UG/KG	19200	55%	50000	0	98	178	3500	2300	630	1200	120 J
Pyridine	UG/KG	0	0%		0	0	100					1900 U
Total Unknown PAHs as SV	MG/KG	25	100%		0	3	3					
Pesticides/PCBs												
4,4'-DDD	UG/KG	740	28%	2900	0	49	178	11	9.8	9.2 J	8.6	19 U
4,4'-DDE	UG/KG	2600	37%	2100	1	65	178	24 J	16 NJ	8.1 NJ	6.4 NJ	19 U
4,4'-DDT	UG/KG	3700	33%	2100	1	59	178	16	19	10	20	19 U
Aldrin	UG/KG	1.2	1%	41	0	1	178	1.9 U	1.8 U	1.9 U	1.9 U	9.7 U

**Table A-2A
SURFACE SOIL SAMPLE RESULTS (0-2 ft.)
SEAD-59
SEAD-59 and SEAD-71 Phase II RI Report
Seneca Army Depot Activity**

Facility	SEAD-59	SEAD-59	SEAD-59	SEAD-59	SEAD-59
Location ID	WS-59-04-010-5	WS-59-04-010-6	WS-59-04-010-7	WS-59-04-010-9	WS-59-OTHERC-001-1
Maxtrix	SOIL	SOIL	SOIL	SOIL	SOIL
Sample ID	WS-59-04-010-5	WS-59-04-010-6	WS-59-04-010-7	WS-59-04-010-9	WS-59-OTHERC-001-1
Sample Depth to Top of Sample ⁽¹⁾	0	0	0	0	0
Sample Depth to Bottom of Sample ⁽¹⁾	0	0	0	0	0
Sample Date	5/6/2004	5/6/2004	5/6/2004	5/6/2004	5/6/2004
QC Code	SA	SA	SA	SA	SA
Study ID	ENSR IRM	ENSR IRM	ENSR IRM	ENSR IRM	ENSR IRM
Sample Round	1	1	1	1	1

Parameter	Units	Maximum	Frequency of	NYSDEC	Number of	Number of	Number of	Value (Q)	Value (Q)	Value (Q)	Value (Q)	Value (Q)
		Value	Detection	TAGM 4046 ⁽²⁾	Exceedances	Detects	Analyses ⁽³⁾					
Alpha-BHC	UG/KG	0	0%	110	0	0	178	1.9 U	1.8 U	1.9 U	1.9 U	9.7 U
Alpha-Chlordane	UG/KG	34	4%		0	7	178	1.9 U	1.8 U	1.9 U	12	9.7 U
Beta-BHC	UG/KG	2.4	1%	200	0	1	178	1.9 U	1.8 U	1.9 U	1.9 U	9.7 U
Delta-BHC	UG/KG	0	0%	300	0	0	178	1.9 U	1.8 U	1.9 U	1.9 U	9.7 U
Dieldrin	UG/KG	0	0%	44	0	0	178	3.8 U	3.6 U	3.7 U	3.7 U	19 U
Endosulfan I	UG/KG	16	1%	900	0	1	178	1.9 U	1.8 U	1.9 U	1.9 U	9.7 U
Endosulfan II	UG/KG	0	0%	900	0	0	178	3.8 U	3.6 U	3.7 U	3.7 U	19 U
Endosulfan sulfate	UG/KG	6.2	1%	1000	0	1	178	3.8 U	3.6 U	3.7 U	3.7 U	19 U
Endrin	UG/KG	16	2%	100	0	3	178	3.8 U	3.6 U	3.7 U	3.7 U	19 U
Endrin aldehyde	UG/KG	4.9	1%		0	2	178	3.8 U	3.6 U	3.7 U	3.7 U	19 U
Endrin ketone	UG/KG	38	2%		0	4	178	3.8 U	3.6 U	3.7 U	3.7 U	19 U
Gamma-BHC/Lindane	UG/KG	0	0%	60	0	0	178	1.9 U	1.8 U	1.9 U	1.9 U	9.7 U
Gamma-Chlordane	UG/KG	24	8%	540	0	14	178	14 J	8	9.8 J	9.1	9.7 U
Heptachlor	UG/KG	0	0%	100	0	0	178	1.9 U	1.8 U	1.9 U	1.9 U	9.7 U
Heptachlor epoxide	UG/KG	3	1%	20	0	2	178	1.9 U	1.8 U	1.9 U	1.9 U	9.7 U
Methoxychlor	UG/KG	0	0%		0	0	178	19 U	18 U	19 U	19 U	97 U
Toxaphene	UG/KG	0	0%		0	0	178	190 U	180 U	190 U	190 U	190 U
Aroclor-1016	UG/KG	0	0%		0	0	178	38 U	36 U	38 U	37 U	38 U
Aroclor-1221	UG/KG	0	0%		0	0	178	38 U	36 U	38 U	37 U	38 U
Aroclor-1232	UG/KG	0	0%		0	0	178	38 U	36 U	38 U	37 U	38 U
Aroclor-1242	UG/KG	0	0%		0	0	178	38 U	36 U	38 U	37 U	38 U
Aroclor-1248	UG/KG	0	0%		0	0	178	38 U	36 U	38 U	37 U	38 U
Aroclor-1254	UG/KG	0	0%	10000	0	0	178	38 U	36 U	38 U	37 U	38 U
Aroclor-1260	UG/KG	79	1%	10000	0	2	178	38 U	36 U	38 U	37 U	38 U
Metals												
Aluminum	MG/KG	18300	100%	19300	0	178	178	12200	9710	7840	7710 J	13900
Antimony	MG/KG	424	58%	5.9	5	104	178	2 J	1.8 J	1.1 J	1.3 J	3.3 UJ
Arsenic	MG/KG	32.2	100%	8.2	7	178	178	8.4	4.9	5	3.9 J	5.9
Barium	MG/KG	304	100%	300	1	178	178	90.3	84.2	65.3	97.9 J	130
Beryllium	MG/KG	2.6	99%	1.1	2	176	178	0.63	0.47	0.4	0.38	0.53
Cadmium	MG/KG	3.2	86%	2.3	2	153	178	0.54	0.49	0.46	0.38	0.46 J
Calcium	MG/KG	214000	100%	121000	1	178	178	30400	46600	79200	81300	13900
Chromium	MG/KG	39.3	100%	29.6	2	178	178	20.4 J	25.3 J	13.5 J	13.4 J	20.2
Cobalt	MG/KG	47.8	100%	30	2	178	178	10.1 J	8.1 J	6.8 J	6.7 J	11.7
Copper	MG/KG	305	100%	33	19	178	178	35.3	35.6	34.8	31.3 J	25.4
Cyanide	MG/KG	0	0%	0.35	0	0	9					
Iron	MG/KG	64000	100%	36500	1	178	178	24600 J	19700 J	17900 J	17200	25100 J
Lead	MG/KG	164	100%	24.8	75	178	178	31 J	26.2 J	25 J	38.2 J	42.7 J
Magnesium	MG/KG	30200	100%	21500	3	178	178	7590 J	9500 J	15500 J	19100 J	4280
Manganese	MG/KG	1290	100%	1060	3	178	178	519 J	411 J	368 J	362 J	771 J
Mercury	MG/KG	0.95	95%	0.1	37	169	178	0.42 J	0.95 J	0.51 J	0.4 J	0.16
Nickel	MG/KG	88.3	100%	49	3	178	178	31.6 J	26.2 J	21.3 J	20.6 J	25.5
Potassium	MG/KG	2290	100%	2380	0	178	178	1380	1140	1090	1030 J	1180
Selenium	MG/KG	1.5	9%	2	0	16	178	0.43 U	0.43 U	0.43 U	0.37 U	0.56 U
Silver	MG/KG	2.9	49%	0.75	62	87	178	2.1	2.6	2.1	1.9 J	0.56 U

Table A-2A
SURFACE SOIL SAMPLE RESULTS (0-2 ft.)
SEAD-59
SEAD-59 and SEAD-71 Phase II RI Report
Seneca Army Depot Activity

Facility	SEAD-59	SEAD-59	SEAD-59	SEAD-59	SEAD-59
Location ID	WS-59-04-010-5	WS-59-04-010-6	WS-59-04-010-7	WS-59-04-010-9	WS-59-OTHERC-001-1
Maxtrix	SOIL	SOIL	SOIL	SOIL	SOIL
Sample ID	WS-59-04-010-5	WS-59-04-010-6	WS-59-04-010-7	WS-59-04-010-9	WS-59-OTHERC-001-1
Sample Depth to Top of Sample ⁽¹⁾	0	0	0	0	0
Sample Depth to Bottom of Sample ⁽¹⁾	0	0	0	0	0
Sample Date	5/6/2004	5/6/2004	5/6/2004	5/6/2004	5/6/2004
QC Code	SA	SA	SA	SA	SA
Study ID	ENSR IRM	ENSR IRM	ENSR IRM	ENSR IRM	ENSR IRM
Sample Round	1	1	1	1	1

Parameter	Units	Maximum	Frequency of	NYSDEC	Number of	Number of	Number of	Value (Q)	Value (Q)	Value (Q)	Value (Q)	Value (Q)
		Value	Detection	TAGM 4046 ⁽²⁾	Exceedances	Detects	Analyses ⁽³⁾					
Sodium	MG/KG	4060	99%	172	86	177	178	97.1	112	137	147 J	228
Thallium	MG/KG	1.8	29%	0.7	24	51	178	0.22 U	0.21 U	0.22 U	0.19 U	0.83 J
Vanadium	MG/KG	28.5	100%	150	0	178	178	21.4	16.4	14.7	13.5 J	25
Zinc	MG/KG	341	100%	110	19	178	178	87.4 J	81.3 J	72.9 J	61.6 J	86.1 J

- Note(s):
(1) - Historical sample depths are presented (I.e. prior to 2002 TCRA)
(2) - NYSDEC Technical and Administrative Guidance Memorandum (TAGM) HWR-94-4046, Revised January 24, 1994
(3) - Sample/Duplicate pair are presented as individual samples in this table. Statistical information used Sample Duplicate pairs as a single entity and averaged result values were used in risk assessment analysis.

U = compound was not detected
J = the reported value is an estimated concentration
UJ = the compound was not detected; the associated reporting limit is approximate
R = the data was rejected in the data validating process
NJ = compound was "tentatively identified" and the associated numerical value is approximate

**Table A-2A
SURFACE SOIL SAMPLE RESULTS (0-2 ft.)
SEAD-59
SEAD-59 and SEAD-71 Phase II RI Report
Seneca Army Depot Activity**

Facility	SEAD-59	SEAD-59	SEAD-59
Location ID	FD-59-CL-01/CL-59-OTHERC-WN1	FD-59-CL-02/CL-59-02-F02	FD-59-CL-05/CL-59-01-WS1
Maxtrix	SOIL	SOIL	SOIL
Sample ID	FD-59-CL-01/CL-59-OTHERC-WN1	FD-59-CL-02/CL-59-02-F02	FD-59-CL-05/CL-59-01-WS1
Sample Depth to Top of Sample ⁽¹⁾	0	0	0
Sample Depth to Bottom of Sample ⁽¹⁾	0	0	0
Sample Date	38113	38113	38113
QC Code	SA/DU	SA/DU	SA/DU
Study ID	ENSR IRM	ENSR IRM	ENSR IRM
Sample Round	1	1	1

Parameter	Units	Maximum Value	Frequency of Detection	NYSDEC TAGM 4046 ⁽²⁾	Number of Exceedances	Number of Detects	Number of Analyses ⁽³⁾	Value (Q)		
								Value (Q)	Value (Q)	Value (Q)
Volatile Organics										
1,1,1-Trichloroethane	UG/KG	0	0%	800	0	0	177	5.55 U	6 U	6.05 U
1,1,2,2-Tetrachloroethane	UG/KG	0	0%	600	0	0	169	5.55 U	6 UJ	6.05 U
1,1,2-Trichloro-1,2,2-Trifluoroethane	UG/KG	0	0%		0	0	168	5.55 U	6 U	6.05 U
1,1,2-Trichloroethane	UG/KG	0	0%		0	0	107		6 U	
1,1-Dichloroethane	UG/KG	0	0%	200	0	0	177	5.55 U	6 U	6.05 U
1,1-Dichloroethene	UG/KG	8	2%	400	0	3	177	5.55 U	6 U	6.05 U
1,2,3-Trichloropropane	UG/KG	0	0%		0	0	70	5.55 U		6.05 U
1,2,4-Trichlorobenzene	UG/KG	0	0%	3400	0	0	161	5.55 U	6 UJ	6.05 U
1,2-Dibromo-3-chloropropane	UG/KG	0	0%		0	0	91		6 UJ	
1,2-Dibromoethane	UG/KG	0	0%		0	0	98		6 U	
1,2-Dichlorobenzene	UG/KG	0	0%	7900	0	0	161	5.55 U	6 UJ	6.05 U
1,2-Dichloroethane	UG/KG	0	0%	100	0	0	177	5.55 U	6 U	6.05 U
1,2-Dichloroethene (total)	UG/KG	0	0%		0	0	9			
1,2-Dichloropropane	UG/KG	0	0%		0	0	107		6 U	
1,3-Dichlorobenzene	UG/KG	0	0%	1600	0	0	161	5.55 U	6 UJ	6.05 U
1,3-Dichloropropane	UG/KG	0	0%		0	0	70	5.55 U		6.05 U
1,4-Dichlorobenzene	UG/KG	0	0%	8500	0	0	161	5.55 U	6 UJ	6.05 U
Acetone	UG/KG	550	27%	200	2	47	177	22 U	9 U	15.25 J
Benzene	UG/KG	3	4%	60	0	7	177	5.55 U	6 U	6.05 U
Bromodichloromethane	UG/KG	0	0%		0	0	107		6 U	
Bromoform	UG/KG	0	0%		0	0	107		6 UJ	
Carbon disulfide	UG/KG	4	3%	2700	0	6	177	5.55 U	6 U	6.05 U
Carbon tetrachloride	UG/KG	0	0%	600	0	0	177	5.55 U	6 U	6.05 U
Chlorobenzene	UG/KG	0	0%	1700	0	0	177	5.55 U	6 U	6.05 U
Chlorodibromomethane	UG/KG	0	0%		0	0	177	5.55 U	6 U	6.05 U
Chloroethane	UG/KG	0	0%	1900	0	0	177	11.5 U	6 U	12 U
Chloroform	UG/KG	0	0%	300	0	0	177	5.55 U	6 U	6.05 U
Cis-1,2-Dichloroethene	UG/KG	0	0%		0	0	98		6 U	
Cis-1,3-Dichloropropene	UG/KG	0	0%		0	0	107		6 U	
Cyclohexane	UG/KG	3	8%		0	8	98		1 J	
Dichlorodifluoromethane	UG/KG	0	0%		0	0	98		6 U	
Ethyl benzene	UG/KG	4.6	1%	5500	0	2	177	5.55 U	6 U	6.05 U
Isopropylbenzene	UG/KG	0	0%		0	0	98		6 U	
Meta/Para Xylene	UG/KG	9.4	4%		0	3	70	5.55 U		6.05 U
Methyl Acetate	UG/KG	2	3%		0	3	98		6 U	
Methyl Tertbutyl Ether	UG/KG	0	0%		0	0	98		6 U	
Methyl bromide	UG/KG	0	0%		0	0	107		6 U	
Methyl butyl ketone	UG/KG	0	0%		0	0	107		6 U	
Methyl chloride	UG/KG	0	0%		0	0	107		6 U	
Methyl cyclohexane	UG/KG	5	10%		0	10	98		2 J	
Methyl ethyl ketone	UG/KG	190	12%	300	0	22	177	11.5 U	6 U	12 U
Methyl isobutyl ketone	UG/KG	1.9	1%	1000	0	1	177	11.5 U	6 U	12 U
Methylene chloride	UG/KG	4.9	20%	100	0	36	178	5.55 U	6 U	6.05 U
Ortho Xylene	UG/KG	5.05	4%		0	3	70	5.55 U		6.05 U

Table A-2A
SURFACE SOIL SAMPLE RESULTS (0-2 ft.)
SEAD-59
SEAD-59 and SEAD-71 Phase II RI Report
Seneca Army Depot Activity

Facility	SEAD-59	SEAD-59	SEAD-59
Location ID	FD-59-CL-01/CL-59-OTHERC-WN1	FD-59-CL-02/CL-59-02-F02	FD-59-CL-05/CL-59-01-WS1
Maxtrix	SOIL	SOIL	SOIL
Sample ID	FD-59-CL-01/CL-59-OTHERC-WN1	FD-59-CL-02/CL-59-02-F02	FD-59-CL-05/CL-59-01-WS1
Sample Depth to Top of Sample ⁽¹⁾	0	0	0
Sample Depth to Bottom of Sample ⁽¹⁾	0	0	0
Sample Date	38113	38113	38113
QC Code	SA/DU	SA/DU	SA/DU
Study ID	ENSR IRM	ENSR IRM	ENSR IRM
Sample Round	1	1	1

Parameter	Units	Maximum Value	Frequency of Detection	NYSDEC TAGM 4046 ⁽²⁾	Number of Exceedances	Number of Detects	Number of Analyses ⁽³⁾	Value (Q)		
								Value (Q)	Value (Q)	Value (Q)
Styrene	UG/KG	0	0%		0	0	107		6 U	
Tetrachloroethene	UG/KG	6.4	3%	1400	0	5	177	5.55 U	6 U	6.05 U
Toluene	UG/KG	8	8%	1500	0	14	177	5.55 U	1 J	6.05 U
Total BTEX	MG/KG	3.25	67%		0	2	3			
Total Xylenes	UG/KG	3	7%	1200	0	7	102		1 J	
Trans-1,2-Dichloroethene	UG/KG	0	0%	300	0	0	168	5.55 U	6 U	6.05 U
Trans-1,3-Dichloropropene	UG/KG	0	0%		0	0	107		6 U	
Trichloroethene	UG/KG	4.5	5%	700	0	8	177	5.55 U	6 U	6.05 U
Trichlorofluoromethane	UG/KG	6	1%		0	1	98		6 U	
Vinyl chloride	UG/KG	0	0%	200	0	0	177	11.5 U	6 U	12 U
Semivolatile Organics										
1,1'-Biphenyl	UG/KG	254.5	2%		0	2	99		375 U	
1,2,4-Trichlorobenzene	UG/KG	0	0%	3400	0	0	9			
1,2-Dichlorobenzene	UG/KG	0	0%	7900	0	0	9			
1,3-Dichlorobenzene	UG/KG	0	0%	1600	0	0	9			
1,4-Dichlorobenzene	UG/KG	0	0%	8500	0	0	9			
2,2'-oxybis(1-Chloropropane)	UG/KG	0	0%		0	0	105		375 U	
2,4,5-Trichlorophenol	UG/KG	0	0%	100	0	0	178	365 UJ	940 U	400 U
2,4,6-Trichlorophenol	UG/KG	0	0%		0	0	178	365 UJ	375 U	400 U
2,4-Dichlorophenol	UG/KG	0	0%	400	0	0	178	365 UJ	375 U	400 U
2,4-Dimethylphenol	UG/KG	0	0%		0	0	108		375 U	
2,4-Dinitrophenol	UG/KG	0	0%	200	0	0	178	1900 UJ	940 UJ	2050 U
2,4-Dinitrotoluene	UG/KG	0	0%		0	0	178	365 UJ	375 U	400 U
2,6-Dinitrotoluene	UG/KG	0	0%	1000	0	0	178	365 UJ	375 U	400 U
2-Chloronaphthalene	UG/KG	0	0%		0	0	108		375 U	
2-Chlorophenol	UG/KG	0	0%	800	0	0	178	365 UJ	375 U	400 U
2-Methylnaphthalene	UG/KG	1295	19%	36400	0	34	178	365 UJ	375 U	400 U
2-Methylphenol	UG/KG	0	0%	100	0	0	178	365 UJ	375 U	400 U
2-Nitroaniline	UG/KG	0	0%	430	0	0	178	1900 UJ	940 U	2050 U
2-Nitrophenol	UG/KG	0	0%	330	0	0	178	365 UJ	375 U	400 U
3,3'-Dichlorobenzidine	UG/KG	0	0%		0	0	178	365 UJ	375 U	400 U
3-Nitroaniline	UG/KG	0	0%	500	0	0	178	1900 UJ	940 U	2050 U
4,6-Dinitro-2-methylphenol	UG/KG	0	0%		0	0	108		940 U	
4-Bromophenyl phenyl ether	UG/KG	0	0%		0	0	108		375 U	
4-Chloro-3-methylphenol	UG/KG	0	0%	240	0	0	178	365 UJ	375 U	400 U
4-Chloroaniline	UG/KG	1200	1%	220	1	2	178	365 UJ	375 UJ	400 U
4-Chlorophenyl phenyl ether	UG/KG	0	0%		0	0	108		375 U	
4-Methylphenol	UG/KG	150	3%	900	0	5	178	365 UJ	375 U	400 U
4-Nitroaniline	UG/KG	0	0%		0	0	108		940 UJ	
4-Nitrophenol	UG/KG	0	0%	100	0	0	178	1900 UJ	940 U	2050 U
Acenaphthene	UG/KG	2680	24%	50000	0	42	178	365 UJ	375 U	400 U
Acenaphthylene	UG/KG	1700	37%	41000	0	66	178	196.5 J	375 U	218 J
Acetophenone	UG/KG	0	0%		0	0	99		375 U	
Aniline	UG/KG	0	0%		0	0	70	365 UJ		400 U
Anthracene	UG/KG	4395	43%	50000	0	77	178	209 J	375 U	400 U

**Table A-2A
SURFACE SOIL SAMPLE RESULTS (0-2 ft.)
SEAD-59
SEAD-59 and SEAD-71 Phase II RI Report
Seneca Army Depot Activity**

Facility	SEAD-59	SEAD-59	SEAD-59
Location ID	FD-59-CL-01/CL-59-OTHERC-WN1	FD-59-CL-02/CL-59-02-F02	FD-59-CL-05/CL-59-01-WS1
Maxtrix	SOIL	SOIL	SOIL
Sample ID	FD-59-CL-01/CL-59-OTHERC-WN1	FD-59-CL-02/CL-59-02-F02	FD-59-CL-05/CL-59-01-WS1
Sample Depth to Top of Sample ⁽¹⁾	0	0	0
Sample Depth to Bottom of Sample ⁽¹⁾	0	0	0
Sample Date	38113	38113	38113
QC Code	SA/DU	SA/DU	SA/DU
Study ID	ENSR IRM	ENSR IRM	ENSR IRM
Sample Round	1	1	1

Parameter	Units	Maximum Value	Frequency of Detection	NYSDEC TAGM 4046 ⁽²⁾	Number of Exceedances	Number of Detects	Number of Analyses ⁽³⁾	Value (Q)		
								Value (Q)	Value (Q)	Value (Q)
Atrazine	UG/KG	120	1%		0	1	99		375 U	
Benzaldehyde	UG/KG	50	1%		0	1	99		375 UJ	
Benzo(a)anthracene	UG/KG	8900	51%	224	72	90	178	160 J	375 U	270 J
Benzo(a)pyrene	UG/KG	8050	51%	61	84	91	178	155 J	375 U	285 J
Benzo(b)fluoranthene	UG/KG	6800	52%	1100	40	92	178	140 J	375 U	255 J
Benzo(ghi)perylene	UG/KG	5200	46%	50000	0	82	178	113.5 J	375 U	250 J
Benzo(k)fluoranthene	UG/KG	7350	49%	1100	35	88	178	145 J	375 U	260 J
Benzoic Acid	UG/KG	0	0%	2700	0	0	70	1900 UJ		2050 U
Bis(2-Chloroethoxy)methane	UG/KG	0	0%		0	0	108		375 U	
Bis(2-Chloroethyl)ether	UG/KG	0	0%		0	0	108		375 U	
Bis(2-Chloroisopropyl)ether	UG/KG	0	0%		0	0	3			
Bis(2-Ethylhexyl)phthalate	UG/KG	990	19%	50000	0	34	178	365 UJ	375 U	400 U
Butylbenzylphthalate	UG/KG	0	0%	50000	0	0	178	365 UJ	375 U	400 U
Caprolactam	UG/KG	0	0%		0	0	99		375 U	
Carbazole	UG/KG	755	19%		0	20	108		375 U	
Chrysene	UG/KG	8900	51%	400	62	91	178	190 J	375 U	270 J
Di-n-butylphthalate	UG/KG	965	2%	8100	0	4	178	365 UJ	375 U	390 U
Di-n-octylphthalate	UG/KG	0	0%	50000	0	0	178	365 UJ	375 U	400 U
Dibenz(a,h)anthracene	UG/KG	1665	38%	14	67	68	178	365 UJ	375 U	217 J
Dibenzofuran	UG/KG	2350	16%	6200	0	28	178	365 UJ	375 U	400 U
Diethyl phthalate	UG/KG	10	1%	7100	0	1	178	365 UJ	375 U	400 U
Dimethylphthalate	UG/KG	0	0%	2000	0	0	178	365 UJ	375 U	400 U
Fluoranthene	UG/KG	23500	54%	50000	0	97	178	245 J	375 U	295 J
Fluorene	UG/KG	2640	28%	50000	0	49	178	365 UJ	375 U	400 U
Hexachlorobenzene	UG/KG	0	0%	410	0	0	178	365 UJ	375 U	400 U
Hexachlorobutadiene	UG/KG	0	0%		0	0	178	365 UJ	375 U	400 U
Hexachlorocyclopentadiene	UG/KG	0	0%		0	0	108		375 U	
Hexachloroethane	UG/KG	0	0%		0	0	178	365 UJ	375 U	400 U
Indeno(1,2,3-cd)pyrene	UG/KG	4950	47%	3200	2	84	178	102.5 J	375 U	245 J
Isophorone	UG/KG	0	0%	4400	0	0	178	365 UJ	375 U	400 U
N-Nitrosodiphenylamine	UG/KG	100	1%		0	1	108		375 U	
N-Nitrosodipropylamine	UG/KG	0	0%		0	0	108		375 U	
Naphthalene	UG/KG	1800	19%	13000	0	34	178	365 UJ	375 U	400 U
Nitrobenzene	UG/KG	0	0%	200	0	0	178	365 UJ	375 U	400 U
Pentachlorophenol	UG/KG	0	0%	1000	0	0	178	1900 UJ	940 U	2050 U
Phenanthrene	UG/KG	21300	51%	50000	0	90	178	119 J	375 U	234.5 J
Phenol	UG/KG	0	0%	30	0	0	178	365 UJ	375 U	400 U
Pyrene	UG/KG	19200	55%	50000	0	98	178	230 J	375 U	295 J
Pyridine	UG/KG	0	0%		0	0	100	1900 UJ		2050 U
Total Unknown PAHs as SV	MG/KG	25	100%		0	3	3			
Pesticides/PCBs										
4,4'-DDD	UG/KG	740	28%	2900	0	49	178	50.5 J	3.75 U	19.5 U
4,4'-DDE	UG/KG	2600	37%	2100	1	65	178	26.5 J	3.75 U	19.5 U
4,4'-DDT	UG/KG	3700	35%	2100	1	59	178	18.5 U	3.75 U	19.5 U
Aldrin	UG/KG	1.2	1%	41	0	1	178	9.45 U	1.9 U	10 U

**Table A-2A
SURFACE SOIL SAMPLE RESULTS (0-2 ft.)
SEAD-59
SEAD-59 and SEAD-71 Phase II RI Report
Seneca Army Depot Activity**

Facility	SEAD-59	SEAD-59	SEAD-59
Location ID	FD-59-CL-01/CL-59-OTHERC-WN1	FD-59-CL-02/CL-59-02-F02	FD-59-CL-05/CL-59-01-WS1
Maxtrix	SOIL	SOIL	SOIL
Sample ID	FD-59-CL-01/CL-59-OTHERC-WN1	FD-59-CL-02/CL-59-02-F02	FD-59-CL-05/CL-59-01-WS1
Sample Depth to Top of Sample ⁽¹⁾	0	0	0
Sample Depth to Bottom of Sample ⁽¹⁾	0	0	0
Sample Date	38113	38113	38113
QC Code	SA/DU	SA/DU	SA/DU
Study ID	ENSR IRM	ENSR IRM	ENSR IRM
Sample Round	1	1	1

Parameter	Units	Maximum Value	Frequency of Detection	NYSDEC TAGM 4046 ⁽²⁾	Number of Exceedances	Number of Detects	Number of Analyses ⁽³⁾	Value (Q)		
								Value (Q)	Value (Q)	Value (Q)
Alpha-BHC	UG/KG	0	0%	110	0	0	178	9.45 U	1.9 U	10 U
Alpha-Chlordane	UG/KG	34	4%		0	7	178	9.45 U	1.9 U	10 U
Beta-BHC	UG/KG	2.4	1%	200	0	1	178	9.45 U	1.9 U	10 U
Delta-BHC	UG/KG	0	0%	300	0	0	178	9.45 U	1.9 U	10 U
Dieldrin	UG/KG	0	0%	44	0	0	178	18.5 U	3.75 U	19.5 U
Endosulfan I	UG/KG	16	1%	900	0	1	178	9.45 U	1.9 U	10 U
Endosulfan II	UG/KG	0	0%	900	0	0	178	18.5 U	3.75 U	19.5 U
Endosulfan sulfate	UG/KG	6.2	1%	1000	0	1	178	18.5 U	3.75 U	19.5 U
Endrin	UG/KG	16	2%	100	0	3	178	18.5 U	3.75 U	19.5 U
Endrin aldehyde	UG/KG	4.9	1%		0	2	178	18.5 U	3.75 U	19.5 U
Endrin ketone	UG/KG	38	2%		0	4	178	18.5 U	3.75 U	19.5 U
Gamma-BHC/Lindane	UG/KG	0	0%	60	0	0	178	9.45 U	1.9 U	10 U
Gamma-Chlordane	UG/KG	24	8%	540	0	14	178	9.45 U	1.9 U	10 U
Heptachlor	UG/KG	0	0%	100	0	0	178	9.45 U	1.9 U	10 U
Heptachlor epoxide	UG/KG	3	1%	20	0	2	178	9.45 U	1.9 U	10 U
Methoxychlor	UG/KG	0	0%		0	0	178	94.5 U	19 U	100 U
Toxaphene	UG/KG	0	0%		0	0	178	185 U	190 UJ	195 U
Aroclor-1016	UG/KG	0	0%		0	0	178	36.5 U	38 U	40 U
Aroclor-1221	UG/KG	0	0%		0	0	178	36.5 U	38 U	40 U
Aroclor-1232	UG/KG	0	0%		0	0	178	36.5 U	38 U	40 U
Aroclor-1242	UG/KG	0	0%		0	0	178	36.5 U	38 U	40 U
Aroclor-1248	UG/KG	0	0%		0	0	178	36.5 U	38 U	40 U
Aroclor-1254	UG/KG	0	0%	10000	0	0	178	36.5 U	38 U	40 U
Aroclor-1260	UG/KG	79	1%	10000	0	2	178	36.5 U	38 U	40 U
Metals										
Aluminum	MG/KG	18300	100%	19300	0	178	178	12550	7640 J	11200
Antimony	MG/KG	424	58%	5.9	5	104	178	3.3 UJ	1.1 J	3.55 UJ
Arsenic	MG/KG	32.2	100%	8.2	7	178	178	4.85	5.65 J	4.9 J
Barium	MG/KG	304	100%	300	1	178	178	123	43.2 J	129
Beryllium	MG/KG	2.6	99%	1.1	2	176	178	0.425	0.42	0.26
Cadmium	MG/KG	3.2	86%	2.3	2	153	178	0.42 J	0.26 J	0.295 U
Calcium	MG/KG	214000	100%	121000	1	178	178	12000	56300 J	6285 J
Chromium	MG/KG	39.3	100%	29.6	2	178	178	19.05	12.65 J	17.6
Cobalt	MG/KG	47.8	100%	30	2	178	178	8.45	8.1 J	11.35
Copper	MG/KG	305	100%	33	19	178	178	25.2 J	21 J	17.6
Cyanide	MG/KG	0	0%	0.35	0	0	9			
Iron	MG/KG	64000	100%	36500	1	178	178	21800 J	19600 J	23250 J
Lead	MG/KG	164	100%	24.8	75	178	178	46.1 J	10.15 J	14.8
Magnesium	MG/KG	30200	100%	21500	3	178	178	4290	9345 J	3945
Manganese	MG/KG	1290	100%	1060	3	178	178	509.5 J	429 J	661.5 J
Mercury	MG/KG	0.95	95%	0.1	37	169	178	0.13 J	0.25 J	0.035 J
Nickel	MG/KG	88.3	100%	49	3	178	178	22.35	22.3 J	27.15
Potassium	MG/KG	2290	100%	2380	0	178	178	1177	885.5 J	1090
Selenium	MG/KG	1.5	9%	2	0	16	178	0.55 U	0.395 U	0.59 U
Silver	MG/KG	2.9	49%	0.75	62	87	178	0.55 U	0.98 J	0.59 U

**Table A-2A
SURFACE SOIL SAMPLE RESULTS (0-2 ft.)
SEAD-59
SEAD-59 and SEAD-71 Phase II RI Report
Seneca Army Depot Activity**

Facility	SEAD-59	SEAD-59	SEAD-59
Location ID	FD-59-CL-01/CL-59-OTHERC-WN1	FD-59-CL-02/CL-59-02-F02	FD-59-CL-05/CL-59-01-WS1
Maxtrix	SOIL	SOIL	SOIL
Sample ID	FD-59-CL-01/CL-59-OTHERC-WN1	FD-59-CL-02/CL-59-02-F02	FD-59-CL-05/CL-59-01-WS1
Sample Depth to Top of Sample ⁽¹⁾	0	0	0
Sample Depth to Bottom of Sample ⁽¹⁾	0	0	0
Sample Date	38113	38113	38113
QC Code	SA/DU	SA/DU	SA/DU
Study ID	ENSR IRM	ENSR IRM	ENSR IRM
Sample Round	1	1	1

Parameter	Units	Maximum Value	Frequency of Detection	NYSDEC TAGM 4046 ⁽²⁾	Number of Exceedances	Number of Detects	Number of Analyses ⁽³⁾	Value (Q)		
								Value (Q)	Value (Q)	Value (Q)
Sodium	MG/KG	4060	99%	172	86	177	178	301 J	152.5 J	178.85 J
Thallium	MG/KG	1.8	29%	0.7	24	51	178	0.625 J	0.195 U	0.73 J
Vanadium	MG/KG	28.5	100%	150	0	178	178	21.55	14.2 J	21.2
Zinc	MG/KG	341	100%	110	19	178	178	126.35 J	73.55 J	80.65 J

- Note(s):
(1) - Historical sample depths are presented (I.e. prior to 2002 TCRA)
(2) - NYSDEC Technical and Administrative Guidance Memorandum (TAGM) HWR-94-4046, Revised January 24, 1994
(3) - Sample/Duplicate pair are presented as individual samples in this table. Statistical information used Sample Duplicate pairs as a single entity and averaged result values were used in risk assessment analysis.

U = compound was not detected
J = the reported value is an estimated concentration
UJ = the compound was not detected; the associated reporting limit is approximate
R = the data was rejected in the data validating process
NJ = compound was "tentatively identified" and the associated numerical value is approximate

**Table A-2A
SURFACE SOIL SAMPLE RESULTS (0-2 ft.)
SEAD-59
SEAD-59 and SEAD-71 Phase II RI Report
Seneca Army Depot Activity**

Facility	SEAD-59	SEAD-59	SEAD-59
Location ID	FD-59-CL-06/CL-59-01-F10	FD-59-CL-3/CL-59-01-WW4	FD-59-CL-7/CL-59-01-F23
Maxtrix	SOIL	SOIL	SOIL
Sample ID	FD-59-CL-06/CL-59-01-F10	FD-59-CL-3/CL-59-01-WW4	FD-59-CL-7/CL-59-01-F23
Sample Depth to Top of Sample ⁽¹⁾	0	0	0
Sample Depth to Bottom of Sample ⁽¹⁾	0	0	0
Sample Date	38113	38113	38113
QC Code	SA/DU	SA/DU	SA/DU
Study ID	ENSR IRM	ENSR IRM	ENSR IRM
Sample Round	1	1	1

Parameter	Units	Maximum Value	Frequency of Detection	NYSDEC TAGM 4046 ⁽²⁾	Number of Exceedances	Number of Detects	Number of Analyses ⁽³⁾	Value (Q)	Value (Q)	Value (Q)
Volatile Organics										
1,1,1-Trichloroethane	UG/KG	0	0%	800	0	0	177	5 U	5 U	5.5 U
1,1,2,2-Tetrachloroethane	UG/KG	0	0%	600	0	0	169	5 U	5 UJ	5.5 U
1,1,2-Trichloro-1,2,2-Trifluoroethane	UG/KG	0	0%	0	0	0	168	5 U	5 U	5.5 U
1,1,2-Trichloroethane	UG/KG	0	0%	0	0	0	107	5 U	5 U	5.5 U
1,1-Dichloroethane	UG/KG	0	0%	200	0	0	177	5 U	5 U	5.5 U
1,1-Dichloroethene	UG/KG	8	2%	400	0	3	177	5 U	5 U	5.5 U
1,2,3-Trichloropropane	UG/KG	0	0%	0	0	0	70	0	0	0
1,2,4-Trichlorobenzene	UG/KG	0	0%	3400	0	0	161	5 U	5 UJ	5.5 U
1,2-Dibromo-3-chloropropane	UG/KG	0	0%	0	0	0	91	5 U	5 UJ	5.5 U
1,2-Dibromoethane	UG/KG	0	0%	0	0	0	98	5 U	5 UJ	5.5 U
1,2-Dichlorobenzene	UG/KG	0	0%	7900	0	0	161	5 U	5 UJ	5.5 U
1,2-Dichloroethane	UG/KG	0	0%	100	0	0	177	5 U	5 U	5.5 U
1,2-Dichloroethene (total)	UG/KG	0	0%	0	0	0	9	0	0	0
1,2-Dichloropropane	UG/KG	0	0%	0	0	0	107	5 U	5 U	5.5 U
1,3-Dichlorobenzene	UG/KG	0	0%	1600	0	0	161	5 U	5 UJ	5.5 U
1,3-Dichloropropane	UG/KG	0	0%	0	0	0	70	0	0	0
1,4-Dichlorobenzene	UG/KG	0	0%	8500	0	0	161	5 U	5 UJ	5.5 U
Acetone	UG/KG	550	27%	200	2	47	177	47 NJ	7.5 J	61 NJ
Benzene	UG/KG	3	4%	60	0	7	177	5 U	5 U	5.5 U
Bromodichloromethane	UG/KG	0	0%	0	0	0	107	5 U	5 U	5.5 U
Bromoform	UG/KG	0	0%	0	0	0	107	5 U	5 UJ	5.5 U
Carbon disulfide	UG/KG	4	3%	2700	0	6	177	5 U	5 U	5.5 U
Carbon tetrachloride	UG/KG	0	0%	600	0	0	177	5 U	5 U	5.5 U
Chlorobenzene	UG/KG	0	0%	1700	0	0	177	5 U	5 UJ	5.5 U
Chlorodibromomethane	UG/KG	0	0%	0	0	0	177	5 U	5 UJ	5.5 U
Chloroethane	UG/KG	0	0%	1900	0	0	177	5 U	5 U	5.5 U
Chloroform	UG/KG	0	0%	300	0	0	177	5 U	5 U	5.5 U
Cis-1,2-Dichloroethene	UG/KG	0	0%	0	0	0	98	5 U	5 U	5.5 U
Cis-1,3-Dichloropropene	UG/KG	0	0%	0	0	0	107	5 U	5 U	5.5 U
Cyclohexane	UG/KG	3	8%	0	0	8	98	5 U	5 U	5.5 U
Dichlorodifluoromethane	UG/KG	0	0%	0	0	0	98	5 U	5 UJ	5.5 U
Ethyl benzene	UG/KG	4.6	1%	5500	0	2	177	5 U	5 UJ	5.5 U
Isopropylbenzene	UG/KG	0	0%	0	0	0	98	5 U	5 UJ	5.5 U
Meta/Para Xylene	UG/KG	9.4	4%	0	0	3	70	0	0	0
Methyl Acetate	UG/KG	2	3%	0	0	3	98	5 U	5 U	5.5 U
Methyl Tertbutyl Ether	UG/KG	0	0%	0	0	0	98	5 U	5 U	5.5 UJ
Methyl bromide	UG/KG	0	0%	0	0	0	107	5 U	5 U	5.5 UJ
Methyl butyl ketone	UG/KG	0	0%	0	0	0	107	5 U	5 UJ	5.5 UJ
Methyl chloride	UG/KG	0	0%	0	0	0	107	5 U	5 U	5.5 U
Methyl cyclohexane	UG/KG	5	10%	0	0	10	98	5 U	5 U	5.5 U
Methyl ethyl ketone	UG/KG	190	12%	300	0	22	177	5 U	5 U	10 J
Methyl isobutyl ketone	UG/KG	1.9	1%	1000	0	1	177	5 U	5 U	5.5 UJ
Methylene chloride	UG/KG	4.9	20%	100	0	36	178	5.5 U	5.5 U	5.5 UJ
Ortho Xylene	UG/KG	5.05	4%	0	0	3	70	0	0	0

Table A-2A
SURFACE SOIL SAMPLE RESULTS (0-2 ft.)
SEAD-59
SEAD-59 and SEAD-71 Phase II RI Report
Seneca Army Depot Activity

Facility	SEAD-59	SEAD-59	SEAD-59
Location ID	FD-59-CL-06/CL-59-01-F10	FD-59-CL-3/CL-59-01-WW4	FD-59-CL-7/CL-59-01-F23
Matrix	SOIL	SOIL	SOIL
Sample ID	FD-59-CL-06/CL-59-01-F10	FD-59-CL-3/CL-59-01-WW4	FD-59-CL-7/CL-59-01-F23
Sample Depth to Top of Sample ⁽¹⁾	0	0	0
Sample Depth to Bottom of Sample ⁽¹⁾	0	0	0
Sample Date	38113	38113	38113
QC Code	SA/DU	SA/DU	SA/DU
Study ID	ENSR IRM	ENSR IRM	ENSR IRM
Sample Round	1	1	1

Parameter	Units	Maximum Value	Frequency of Detection	NYSDEC TAGM 4046 ⁽²⁾	Number of Exceedances	Number of Detects	Number of Analyses ⁽³⁾	Value (Q)	Value (Q)	Value (Q)
Styrene	UG/KG	0	0%		0	0	107	5 U	5 UJ	5.5 U
Tetrachloroethene	UG/KG	6.4	3%	1400	0	5	177	5 U	5 UJ	5.5 U
Toluene	UG/KG	8	8%	1500	0	14	177	5 U	5 U	5.5 U
Total BTEX	MG/KG	3.25	67%		0	2	3			
Total Xylenes	UG/KG	3	7%	1200	0	7	102	5 U	5 UJ	5.5 U
Trans-1,2-Dichloroethene	UG/KG	0	0%	300	0	0	168	5 U	5 U	5.5 U
Trans-1,3-Dichloropropene	UG/KG	0	0%		0	0	107	5 U	5 U	5.5 U
Trichloroethene	UG/KG	4.5	5%	700	0	8	177	5 U	5 U	5.5 U
Trichlorofluoromethane	UG/KG	6	1%		0	1	98	5 U	5 U	5.5 U
Vinyl chloride	UG/KG	0	0%	200	0	0	177	5 U	5 U	5.5 U
Semivolatile Organics										
1,1'-Biphenyl	UG/KG	254.5	2%		0	2	99	375 U	370 U	385 U
1,2,4-Trichlorobenzene	UG/KG	0	0%	3400	0	0	9			
1,2-Dichlorobenzene	UG/KG	0	0%	7900	0	0	9			
1,3-Dichlorobenzene	UG/KG	0	0%	1600	0	0	9			
1,4-Dichlorobenzene	UG/KG	0	0%	8500	0	0	9			
2,2'-oxybis(1-Chloropropane)	UG/KG	0	0%		0	0	105	375 UJ	370 U	385 U
2,4,5-Trichlorophenol	UG/KG	0	0%	100	0	0	178	940 U	920 U	960 U
2,4,6-Trichlorophenol	UG/KG	0	0%		0	0	178	375 U	370 U	385 U
2,4-Dichlorophenol	UG/KG	0	0%	400	0	0	178	375 U	370 U	385 U
2,4-Dimethylphenol	UG/KG	0	0%		0	0	108	375 U	370 U	385 U
2,4-Dinitrophenol	UG/KG	0	0%	200	0	0	178	940 U	920 U	960 U
2,4-Dinitrotoluene	UG/KG	0	0%		0	0	178	375 U	370 U	385 U
2,6-Dinitrotoluene	UG/KG	0	0%	1000	0	0	178	375 U	370 U	385 U
2-Chloronaphthalene	UG/KG	0	0%		0	0	108	375 U	370 U	385 U
2-Chlorophenol	UG/KG	0	0%	800	0	0	178	375 U	370 U	385 U
2-Methylnaphthalene	UG/KG	1295	19%	36400	0	34	178	375 U	370 U	385 U
2-Methylphenol	UG/KG	0	0%	100	0	0	178	375 U	370 U	385 U
2-Nitroaniline	UG/KG	0	0%	430	0	0	178	940 U	920 U	960 U
2-Nitrophenol	UG/KG	0	0%	330	0	0	178	375 U	370 U	385 U
3,3'-Dichlorobenzidine	UG/KG	0	0%		0	0	178	375 UJ	370 U	385 U
3-Nitroaniline	UG/KG	0	0%	500	0	0	178	940 U	920 U	960 U
4,6-Dinitro-2-methylphenol	UG/KG	0	0%		0	0	108	940 U	920 U	960 U
4-Bromophenyl phenyl ether	UG/KG	0	0%		0	0	108	375 U	370 U	385 U
4-Chloro-3-methylphenol	UG/KG	0	0%	240	0	0	178	375 U	370 U	385 U
4-Chloroaniline	UG/KG	1200	1%	220	1	2	178	375 U	370 U	385 U
4-Chlorophenyl phenyl ether	UG/KG	0	0%		0	0	108	375 U	370 U	385 U
4-Methylphenol	UG/KG	150	3%	900	0	5	178	375 U	370 U	385 U
4-Nitroaniline	UG/KG	0	0%		0	0	108	940 U	920 U	960 U
4-Nitrophenol	UG/KG	0	0%	100	0	0	178	940 U	920 U	960 U
Acenaphthene	UG/KG	2680	24%	50000	0	42	178	375 U	370 U	385 U
Acenaphthylene	UG/KG	1700	37%	41000	0	66	178	375 U	202.5 J	385 U
Acetophenone	UG/KG	0	0%		0	0	99	375 U	370 U	385 U
Aniline	UG/KG	0	0%		0	0	70			
Anthracene	UG/KG	4395	43%	50000	0	77	178	375 U	231 J	385 U

**Table A-2A
SURFACE SOIL SAMPLE RESULTS (0-2 ft.)
SEAD-59
SEAD-59 and SEAD-71 Phase II RI Report
Seneca Army Depot Activity**

Facility	SEAD-59	SEAD-59	SEAD-59
Location ID	FD-59-CL-06/CL-59-01-F10	FD-59-CL-3/CL-59-01-WW4	FD-59-CL-7/CL-59-01-F23
Matrix	SOIL	SOIL	SOIL
Sample ID	FD-59-CL-06/CL-59-01-F10	FD-59-CL-3/CL-59-01-WW4	FD-59-CL-7/CL-59-01-F23
Sample Depth to Top of Sample ⁽¹⁾	0	0	0
Sample Depth to Bottom of Sample ⁽¹⁾	0	0	0
Sample Date	38113	38113	38113
QC Code	SA/DU	SA/DU	SA/DU
Study ID	ENSR IRM	ENSR IRM	ENSR IRM
Sample Round	1	1	1

Parameter	Units	Maximum	Frequency of	NYSDEC	Number of	Number of	Number of	Value (Q)	Value (Q)	Value (Q)
		Value	Detection	TAGM 4046 ⁽²⁾	Exceedances	Detects	Analyses ⁽³⁾			
Atrazine	UG/KG	120	1%		0	1	99	375 U	370 U	385 U
Benzaldehyde	UG/KG	50	1%		0	1	99	375 U	370 U	385 U
Benzo(a)anthracene	UG/KG	8900	51%	224	72	90	178	375 U	290 J	385 U
Benzo(a)pyrene	UG/KG	8050	51%	61	84	91	178	375 U	295 J	385 U
Benzo(b)fluoranthene	UG/KG	6800	52%	1100	40	92	178	375 U	325 J	385 U
Benzo(ghi)perylene	UG/KG	5200	46%	50000	0	82	178	375 U	250 J	385 U
Benzo(k)fluoranthene	UG/KG	7350	49%	1100	35	88	178	375 U	235 J	385 U
Benzoic Acid	UG/KG	0	0%	2700	0	0	70			
Bis(2-Chloroethoxy)methane	UG/KG	0	0%		0	0	108	375 U	370 U	385 U
Bis(2-Chloroethyl)ether	UG/KG	0	0%		0	0	108	375 U	370 U	385 U
Bis(2-Chloroisopropyl)ether	UG/KG	0	0%		0	0	3			
Bis(2-Ethylhexyl)phthalate	UG/KG	990	19%	50000	0	34	178	375 U	194.5 J	385 U
Butylbenzylphthalate	UG/KG	0	0%	50000	0	0	178	375 U	370 U	385 U
Caprolactam	UG/KG	0	0%		0	0	99	375 U	370 U	385 U
Carbazole	UG/KG	755	19%		0	20	108	375 U	213.5 J	385 U
Chrysene	UG/KG	8900	51%	400	62	91	178	375 U	300 J	385 U
Di-n-butylphthalate	UG/KG	965	2%	8100	0	4	178	375 U	370 U	385 U
Di-n-octylphthalate	UG/KG	0	0%	50000	0	0	178	375 U	370 U	385 U
Dibenz(a,h)anthracene	UG/KG	1665	38%	14	67	68	178	375 U	201 J	385 U
Dibenzofuran	UG/KG	2350	16%	6200	0	28	178	375 U	370 U	385 U
Diethyl phthalate	UG/KG	10	1%	7100	0	1	178	375 U	370 U	385 U
Dimethylphthalate	UG/KG	0	0%	2000	0	0	178	375 U	370 U	385 U
Fluoranthene	UG/KG	23500	54%	50000	0	97	178	375 U	450 J	385 U
Fluorene	UG/KG	2640	28%	50000	0	49	178	375 U	200 J	385 U
Hexachlorobenzene	UG/KG	0	0%	410	0	0	178	375 U	370 U	385 U
Hexachlorobutadiene	UG/KG	0	0%		0	0	178	375 U	370 U	385 U
Hexachlorocyclopentadiene	UG/KG	0	0%		0	0	108	375 U	370 U	385 U
Hexachloroethane	UG/KG	0	0%		0	0	178	375 U	370 U	385 U
Indeno(1,2,3-cd)pyrene	UG/KG	4950	47%	3200	2	84	178	375 U	250 J	385 U
Isophorone	UG/KG	0	0%	4400	0	0	178	375 U	370 U	385 U
N-Nitrosodiphenylamine	UG/KG	100	1%		0	1	108	375 U	370 U	385 U
N-Nitrosodipropylamine	UG/KG	0	0%		0	0	108	375 U	370 U	385 U
Naphthalene	UG/KG	1800	19%	13000	0	34	178	375 U	370 U	385 U
Nitrobenzene	UG/KG	0	0%	200	0	0	178	375 U	370 U	385 U
Pentachlorophenol	UG/KG	0	0%	1000	0	0	178	940 U	920 U	960 U
Phenanthrene	UG/KG	21300	51%	50000	0	90	178	375 U	370 J	385 U
Phenol	UG/KG	0	0%	30	0	0	178	375 U	370 U	385 U
Pyrene	UG/KG	19200	55%	50000	0	98	178	375 U	435 J	385 U
Pyridine	UG/KG	0	0%		0	0	100	375 U		385 U
Total Unknown PAHs as SV	MG/KG	25	100%		0	3	3			
Pesticides/PCBs										
4,4'-DDD	UG/KG	740	28%	2900	0	49	178	3.7 U	3.7 U	3.8 U
4,4'-DDE	UG/KG	2600	37%	2100	1	65	178	3.7 U	9.85 J	3.8 U
4,4'-DDT	UG/KG	3700	33%	2100	1	59	178	3.7 U	6.85 J	3.8 U
Aldrin	UG/KG	1.2	1%	41	0	1	178	1.95 U	1.9 U	2 U

**Table A-2A
SURFACE SOIL SAMPLE RESULTS (0-2 ft.)
SEAD-59
SEAD-59 and SEAD-71 Phase II RI Report
Seneca Army Depot Activity**

Facility	SEAD-59	SEAD-59	SEAD-59
Location ID	FD-59-CL-06/CL-59-01-F10	FD-59-CL-3/CL-59-01-WW4	FD-59-CL-7/CL-59-01-F23
Matrix	SOIL	SOIL	SOIL
Sample ID	FD-59-CL-06/CL-59-01-F10	FD-59-CL-3/CL-59-01-WW4	FD-59-CL-7/CL-59-01-F23
Sample Depth to Top of Sample ⁽¹⁾	0	0	0
Sample Depth to Bottom of Sample ⁽¹⁾	0	0	0
Sample Date	38113	38113	38113
QC Code	SA/DU	SA/DU	SA/DU
Study ID	ENSR IRM	ENSR IRM	ENSR IRM
Sample Round	1	1	1

Parameter	Units	Maximum Value	Frequency of Detection	NYSDEC TAGM 4046 ⁽²⁾	Number of Exceedances	Number of Detects	Number of Analyses ⁽³⁾	Value (Q)	Value (Q)	Value (Q)
Alpha-BHC	UG/KG	0	0%	110	0	0	178	1.95 U	1.9 U	2 U
Alpha-Chlordane	UG/KG	34	4%		0	7	178	1.95 U	1.9 U	2 UJ
Beta-BHC	UG/KG	2.4	1%	200	0	1	178	1.95 U	1.9 U	2 U
Delta-BHC	UG/KG	0	0%	300	0	0	178	1.95 U	1.9 U	2 UJ
Dieldrin	UG/KG	0	0%	44	0	0	178	3.7 U	3.7 U	3.8 U
Endosulfan I	UG/KG	16	1%	900	0	1	178	1.95 U	1.9 U	2 U
Endosulfan II	UG/KG	0	0%	900	0	0	178	3.7 U	3.7 U	3.8 U
Endosulfan sulfate	UG/KG	6.2	1%	1000	0	1	178	3.7 U	3.7 U	3.8 U
Endrin	UG/KG	16	2%	100	0	3	178	3.7 U	4.75 J	3.8 U
Endrin aldehyde	UG/KG	4.9	1%		0	2	178	3.7 U	3.7 U	3.8 U
Endrin ketone	UG/KG	38	2%		0	4	178	3.7 U	3.7 U	3.8 U
Gamma-BHC/Lindane	UG/KG	0	0%	60	0	0	178	1.95 U	1.9 U	2 U
Gamma-Chlordane	UG/KG	24	8%	540	0	14	178	1.95 UJ	1.9 U	2 UJ
Heptachlor	UG/KG	0	0%	100	0	0	178	1.95 U	1.9 U	2 U
Heptachlor epoxide	UG/KG	3	1%	20	0	2	178	1.95 U	1.9 U	2 U
Methoxychlor	UG/KG	0	0%		0	0	178	19.5 U	19 U	20 U
Toxaphene	UG/KG	0	0%		0	0	178	195 U	190 U	200 U
Aroclor-1016	UG/KG	0	0%		0	0	178	37.5 U	37.5 U	38.5 U
Aroclor-1221	UG/KG	0	0%		0	0	178	37.5 U	37.5 U	38.5 U
Aroclor-1232	UG/KG	0	0%		0	0	178	37.5 U	37.5 U	38.5 U
Aroclor-1242	UG/KG	0	0%		0	0	178	37.5 U	37.5 U	38.5 U
Aroclor-1248	UG/KG	0	0%		0	0	178	37.5 U	37.5 U	38.5 U
Aroclor-1254	UG/KG	0	0%	10000	0	0	178	37.5 U	37.5 U	38.5 U
Aroclor-1260	UG/KG	79	1%	10000	0	2	178	37.5 U	37.5 U	38.5 U
Metals										
Aluminum	MG/KG	18300	100%	19300	0	178	178	8375 J	12050 J	13700 J
Antimony	MG/KG	424	58%	5.9	5	104	178	1.55 J	1.6 J	2.1 J
Arsenic	MG/KG	32.2	100%	8.2	7	178	178	6.45 J	6.45 J	5.6 J
Barium	MG/KG	304	100%	300	1	178	178	65.8 J	117.5 J	78 J
Beryllium	MG/KG	2.6	99%	1.1	2	176	178	0.415 J	0.635 J	0.72 J
Cadmium	MG/KG	3.2	86%	2.3	2	153	178	0.53 J	0.32 J	0.49 J
Calcium	MG/KG	214000	100%	121000	1	178	178	42010 J	16560 J	3130 J
Chromium	MG/KG	39.3	100%	29.6	2	178	178	13.45 J	17.7 J	19.7 J
Cobalt	MG/KG	47.8	100%	30	2	178	178	8.1 J	8.5 J	10.35 J
Copper	MG/KG	305	100%	33	19	178	178	18.4 J	26.3 J	21.4 J
Cyanide	MG/KG	0	0%	0.35	0	0	9			
Iron	MG/KG	64000	100%	36500	1	178	178	18150 J	22450 J	24000 J
Lead	MG/KG	164	100%	24.8	75	178	178	9.5 J	31.75 J	14.55 J
Magnesium	MG/KG	30200	100%	21500	3	178	178	11280 J	5565 J	4615 J
Manganese	MG/KG	1290	100%	1060	3	178	178	510 J	406.5 J	283 J
Mercury	MG/KG	0.95	95%	0.1	37	169	178	0.025 J	0.14 J	0.045 J
Nickel	MG/KG	88.3	100%	49	3	178	178	24.45 J	24.7 J	27.3 J
Potassium	MG/KG	2290	100%	2380	0	178	178	1044 J	1134 J	783.5 J
Selenium	MG/KG	1.5	9%	2	0	16	178	0.44 J	0.41 U	0.605 J
Silver	MG/KG	2.9	49%	0.75	62	87	178	0.375 J	1.35 J	0.64 J

Table A-2A
SURFACE SOIL SAMPLE RESULTS (0-2 ft.)
SEAD-59
SEAD-59 and SEAD-71 Phase II RI Report
Seneca Army Depot Activity

Facility	SEAD-59	SEAD-59	SEAD-59
Location ID	FD-59-CL-06/CL-59-01-F10	FD-59-CL-3/CL-59-01-WW4	FD-59-CL-7/CL-59-01-F23
Maxtrix	SOIL	SOIL	SOIL
Sample ID	FD-59-CL-06/CL-59-01-F10	FD-59-CL-3/CL-59-01-WW4	FD-59-CL-7/CL-59-01-F23
Sample Depth to Top of Sample ⁽¹⁾	0	0	0
Sample Depth to Bottom of Sample ⁽¹⁾	0	0	0
Sample Date	38113	38113	38113
QC Code	SA/DU	SA/DU	SA/DU
Study ID	ENSR IRM	ENSR IRM	ENSR IRM
Sample Round	1	1	1

Parameter	Units	Maximum Value	Frequency of Detection	NYSDEC TAGM 4046 ⁽²⁾	Number of Exceedances	Number of Detects	Number of Analyses ⁽³⁾	Value (Q)		
								Value (Q)	Value (Q)	Value (Q)
Sodium	MG/KG	4060	99%	172	86	177	178	188.5	61.9	388.5 J
Thallium	MG/KG	1.8	29%	0.7	24	51	178	0.22	0.205 U	0.22 U
Vanadium	MG/KG	28.5	100%	150	0	178	178	14 J	21.25 J	22.1 J
Zinc	MG/KG	341	100%	110	19	178	178	55.75 J	78.2 J	59.65 J

Note(s):

- (1) - Historical sample depths are presented (I.e. prior to 2002 TCRA)
- (2) - NYSDEC Technical and Administrative Guidance Memorandum (TAGM) HWR-94-4046, Revised January 24, 1994
- (3) - Sample/Duplicate pair are presented as individual samples in this table. Statistical information used Sample Duplicate pairs as a single entity and averaged result values were used in risk assessment analysis.

U = compound was not detected

J = the reported value is an estimated concentration

UJ = the compound was not detected; the associated reporting limit is approximate

R = the data was rejected in the data validating process

NJ = compound was "tentatively identified" and the associated numerical value is approximate

**Table A-2A
SURFACE SOIL SAMPLE RESULTS (0-2 ft.)
SEAD-59
SEAD-59 and SEAD-71 Phase II RI Report
Seneca Army Depot Activity**

Facility	SEAD-59	SEAD-59	SEAD-59	SEAD-59
Location ID	FD-71-CL-04/CL-59-01-F01	SB59-1	TP59-9-2	SB59-20
Matrix	SOIL	SOIL	SOIL	SOIL
Sample ID	FD-71-CL-04/CL-59-01-F01	SB59-1-08/SB59-1-04	59052/59053	59066/59107
Sample Depth to Top of Sample ⁽¹⁾	0	6	2	4
Sample Depth to Bottom of Sample ⁽¹⁾	0	8	2.5	4.5
Sample Date	38113	34385	35716	35725
QC Code	SA/DU	SA/DU	SA/DU	SA/DU
Study ID	ENSR IRM	ESI	RI PHASE 1 STEP 1	RI PHASE 1 STEP 1
Sample Round	1			

Parameter	Units	Maximum	Frequency of	NYSDEC	Number of	Number of	Number of	Value (Q)	Value (Q)	Value (Q)	Value (Q)
		Value	Detection	TAGM 4046 ⁽²⁾	Exceedances	Detects	Analyses ⁽³⁾				
Volatile Organics											
1,1,1-Trichloroethane	UG/KG	0	0%	800	0	0	177	5 UJ	13 U	12 U	11 U
1,1,2,2-Tetrachloroethane	UG/KG	0	0%	600	0	0	169	5 UJ	13 U	12 U	11 U
1,1,2-Trichloro-1,2,2-Trifluoroethane	UG/KG	0	0%		0	0	168	5 UJ			
1,1,2-Trichloroethane	UG/KG	0	0%		0	0	107	5 UJ	13 U	12 U	11 U
1,1-Dichloroethane	UG/KG	0	0%	200	0	0	177	5 UJ	13 U	12 U	11 U
1,1-Dichloroethene	UG/KG	8	2%	400	0	3	177	5 UJ	13 U	12 U	11 U
1,2,3-Trichloropropane	UG/KG	0	0%		0	0	70				
1,2,4-Trichlorobenzene	UG/KG	0	0%	3400	0	0	161	5 UJ			
1,2-Dibromo-3-chloropropane	UG/KG	0	0%		0	0	91	5 UJ			
1,2-Dibromoethane	UG/KG	0	0%		0	0	98	5 UJ			
1,2-Dichlorobenzene	UG/KG	0	0%	7900	0	0	161	5 UJ			
1,2-Dichloroethane	UG/KG	0	0%	100	0	0	177	5 UJ	13 U	12 U	11 U
1,2-Dichloroethene (total)	UG/KG	0	0%		0	0	9		13 U	12 U	11 U
1,2-Dichloropropane	UG/KG	0	0%		0	0	107	5 UJ	13 U	12 U	11 U
1,3-Dichlorobenzene	UG/KG	0	0%	1600	0	0	161	5 UJ			
1,3-Dichloropropane	UG/KG	0	0%		0	0	70				
1,4-Dichlorobenzene	UG/KG	0	0%	8500	0	0	161	5 UJ			
Acetone	UG/KG	550	27%	200	2	47	177	27.5 J	47 U	12 U	11 U
Benzene	UG/KG	3	4%	60	0	7	177	3 J	13 U	12 U	11 U
Bromodichloromethane	UG/KG	0	0%		0	0	107	5 UJ	13 U	12 U	11 U
Bromoform	UG/KG	0	0%		0	0	107	5 UJ	13 U	12 U	11 U
Carbon disulfide	UG/KG	4	3%	2700	0	6	177	5 UJ	13 U	12 U	11 U
Carbon tetrachloride	UG/KG	0	0%	600	0	0	177	5 UJ	13 U	12 U	11 U
Chlorobenzene	UG/KG	0	0%	1700	0	0	177	5 UJ	13 U	12 U	11 U
Chlorodibromomethane	UG/KG	0	0%		0	0	177	5 UJ	13 U	12 U	11 U
Chloroethane	UG/KG	0	0%	1900	0	0	177	5 UJ	13 U	12 U	11 U
Chloroform	UG/KG	0	0%	300	0	0	177	5 UJ	13 U	12 U	11 U
Cis-1,2-Dichloroethene	UG/KG	0	0%		0	0	98	5 UJ			
Cis-1,3-Dichloropropene	UG/KG	0	0%		0	0	107	5 UJ	13 U	12 U	11 U
Cyclohexane	UG/KG	3	8%		0	8	98	5 UJ			
Dichlorodifluoromethane	UG/KG	0	0%		0	0	98	5 UJ			
Ethyl benzene	UG/KG	4.6	1%	5500	0	2	177	5 UJ	13 U	12 U	11 U
Isopropylbenzene	UG/KG	0	0%		0	0	98	5 UJ			
Meta/Para Xylene	UG/KG	9.4	4%		0	3	70				
Methyl Acetate	UG/KG	2	3%		0	3	98	5 UJ			
Methyl Tertbutyl Ether	UG/KG	0	0%		0	0	98	5 UJ			
Methyl bromide	UG/KG	0	0%		0	0	107	5 UJ	13 U	12 U	11 U
Methyl butyl ketone	UG/KG	0	0%		0	0	107	5 UJ	13 U	12 U	11 U
Methyl chloride	UG/KG	0	0%		0	0	107	5 UJ	13 U	12 U	11 U
Methyl cyclohexane	UG/KG	5	10%		0	10	98	4.5 J			
Methyl ethyl ketone	UG/KG	190	12%	300	0	22	177	5 UJ	14 U	12 U	11 U
Methyl isobutyl ketone	UG/KG	1.9	1%	1000	0	1	177	5 UJ	13 U	12 U	11 U
Methylene chloride	UG/KG	4.9	20%	100	0	36	178	6.5 UJ	13 U	12 U	11 U
Ortho Xylene	UG/KG	5.05	4%		0	3	70				

Table A-2A
SURFACE SOIL SAMPLE RESULTS (0-2 ft.)
SEAD-59
SEAD-59 and SEAD-71 Phase II RI Report
Seneca Army Depot Activity

Facility	SEAD-59	SEAD-59	SEAD-59	SEAD-59
Location ID	FD-71-CL-04/CL-59-01-F01	SB59-1	TP59-9-2	SB59-20
Matrix	SOIL	SOIL	SOIL	SOIL
Sample ID	FD-71-CL-04/CL-59-01-F01	SB59-1-08/SB59-1-04	59052/59053	59066/59107
Sample Depth to Top of Sample ⁽¹⁾	0	6	2	4
Sample Depth to Bottom of Sample ⁽¹⁾	0	8	2.5	4.5
Sample Date	38113	34385	35716	35725
QC Code	SA/DU	SA/DU	SA/DU	SA/DU
Study ID	ENSR IRM	ESI	RI PHASE 1 STEP 1	RI PHASE 1 STEP 1
Sample Round	1			

Parameter	Units	Maximum Value	Frequency of Detection	NYSDEC TAGM 4046 ⁽²⁾	Number of Exceedances	Number of Detects	Number of Analyses ⁽³⁾	Value (Q)	Value (Q)	Value (Q)	Value (Q)
Styrene	UG/KG	0	0%		0	0	107	5 UJ	13 U	12 U	11 U
Tetrachloroethene	UG/KG	6.4	3%	1400	0	5	177	5 UJ	13 U	12 U	11 U
Toluene	UG/KG	8	8%	1500	0	14	177	3.5 J	13 U	12 U	11 U
Total BTEX	MG/KG	3.25	67%		0	2	3			2.5 U	3.25 J
Total Xylenes	UG/KG	3	7%	1200	0	7	102	5 UJ	13 U	12 U	11 U
Trans-1,2-Dichloroethene	UG/KG	0	0%	300	0	0	168	5 UJ			
Trans-1,3-Dichloropropene	UG/KG	0	0%		0	0	107	5 UJ	13 U	12 U	11 U
Trichloroethene	UG/KG	4.5	5%	700	0	8	177	5 UJ	13 U	12 U	11 U
Trichlorofluoromethane	UG/KG	6	1%		0	1	98	5 UJ			
Vinyl chloride	UG/KG	0	0%	200	0	0	177	5 UJ	13 U	12 U	11 U
Semivolatile Organics											
1,1'-Biphenyl	UG/KG	254.5	2%		0	2	99	360 U			
1,2,4-Trichlorobenzene	UG/KG	0	0%	3400	0	0	9		1160 U	150 U	66 U
1,2-Dichlorobenzene	UG/KG	0	0%	7900	0	0	9		1160 U	150 U	66 U
1,3-Dichlorobenzene	UG/KG	0	0%	1600	0	0	9		1160 U	150 U	66 U
1,4-Dichlorobenzene	UG/KG	0	0%	8500	0	0	9		1160 U	150 U	66 U
2,2'-oxybis(1-Chloropropane)	UG/KG	0	0%		0	0	105	360 U	1160 U		
2,4,5-Trichlorophenol	UG/KG	0	0%	100	0	0	178	905 U	2850 U	370 U	160 U
2,4,6-Trichlorophenol	UG/KG	0	0%		0	0	178	360 U	1160 U	150 U	66 UJ
2,4-Dichlorophenol	UG/KG	0	0%	400	0	0	178	360 U	1160 U	150 U	66 U
2,4-Dimethylphenol	UG/KG	0	0%		0	0	108	360 U	1160 U	150 U	66 U
2,4-Dinitrophenol	UG/KG	0	0%	200	0	0	178	905 UJ	2850 U	370 U	160 UJ
2,4-Dinitrotoluene	UG/KG	0	0%		0	0	178	360 U	1160 U	150 U	66 U
2,6-Dinitrotoluene	UG/KG	0	0%	1000	0	0	178	360 U	1160 U	150 U	66 U
2-Chloronaphthalene	UG/KG	0	0%		0	0	108	360 U	1160 U	150 U	66 U
2-Chlorophenol	UG/KG	0	0%	800	0	0	178	360 U	1160 U	150 U	66 U
2-Methylnaphthalene	UG/KG	1295	19%	36400	0	34	178	360 U	130 J	10 J	14 J
2-Methylphenol	UG/KG	0	0%	100	0	0	178	360 U	1160 U	150 U	66 U
2-Nitroaniline	UG/KG	0	0%	430	0	0	178	905 U	2850 U	370 U	160 U
2-Nitrophenol	UG/KG	0	0%	330	0	0	178	360 U	1160 U	150 U	66 U
3,3'-Dichlorobenzidine	UG/KG	0	0%		0	0	178	360 U	1160 U	150 U	66 UJ
3-Nitroaniline	UG/KG	0	0%	500	0	0	178	905 U	2850 U	370 U	160 UJ
4,6-Dinitro-2-methylphenol	UG/KG	0	0%		0	0	108	905 UJ	2850 U	370 U	160 U
4-Bromophenyl phenyl ether	UG/KG	0	0%		0	0	108	360 U	1160 U	150 U	66 U
4-Chloro-3-methylphenol	UG/KG	0	0%	240	0	0	178	360 U	1160 U	150 U	66 U
4-Chloroaniline	UG/KG	1200	1%	220	1	2	178	360 U	1160 U	150 U	66 UJ
4-Chlorophenyl phenyl ether	UG/KG	0	0%		0	0	108	360 U	1160 U	150 U	66 U
4-Methylphenol	UG/KG	150	3%	900	0	5	178	360 U	1160 U	150 U	66 U
4-Nitroaniline	UG/KG	0	0%		0	0	108	905 U	2850 U	370 U	160 U
4-Nitrophenol	UG/KG	0	0%	100	0	0	178	905 U	2850 U	370 U	160 U
Acenaphthene	UG/KG	2680	24%	50000	0	42	178	204.5 J	275 J	44 J	6.1 J
Acenaphthylene	UG/KG	1700	37%	41000	0	66	178	360 U	380 J	7.9 J	66 U
Acetophenone	UG/KG	0	0%		0	0	99	360 U			
Aniline	UG/KG	0	0%		0	0	70				
Anthracene	UG/KG	4395	43%	50000	0	77	178	209.5 J	835 J	88 J	8.4 J

Table A-2A
SURFACE SOIL SAMPLE RESULTS (0-2 ft.)
SEAD-59
SEAD-59 and SEAD-71 Phase II RI Report
Seneca Army Depot Activity

Facility	SEAD-59	SEAD-59	SEAD-59	SEAD-59
Location ID	FD-71-CL-04/CL-59-01-F01	SB59-1	TP59-9-2	SB59-20
Matrix	SOIL	SOIL	SOIL	SOIL
Sample ID	FD-71-CL-04/CL-59-01-F01	SB59-1-08/SB59-1-04	59052/59053	59066/59107
Sample Depth to Top of Sample ⁽¹⁾	0	6	2	4
Sample Depth to Bottom of Sample ⁽¹⁾	0	8	2.5	4.5
Sample Date	38113	34385	35716	35725
QC Code	SA/DU	SA/DU	SA/DU	SA/DU
Study ID	ENSR IRM	ESI	RI PHASE 1 STEP 1	RI PHASE 1 STEP 1
Sample Round	1			

Parameter	Units	Maximum	Frequency of	NYSDEC	Number of	Number of	Number of	Value (Q)	Value (Q)	Value (Q)	Value (Q)
		Value	Detection	TAGM 4046 ⁽²⁾	Exceedances	Detects	Analyses ⁽³⁾				
Atrazine	UG/KG	120	1%		0	1	99	360 U			
Benzaldehyde	UG/KG	50	1%		0	1	99	360 U			
Benzo(a)anthracene	UG/KG	8900	51%	224	72	90	178	250 J	2890	320	20 J
Benzo(a)pyrene	UG/KG	8050	51%	61	84	91	178	235 J	3185 J	340	22 J
Benzo(b)fluoranthene	UG/KG	6800	52%	1100	40	92	178	245 J	2915 J		19 J
Benzo(ghi)perylene	UG/KG	5200	46%	50000	0	82	178	199 J	1415 J	210	22 J
Benzo(k)fluoranthene	UG/KG	7350	49%	1100	35	88	178	218.5 J	3450 J	300	20 J
Benzoic Acid	UG/KG	0	0%	2700	0	0	70				
Bis(2-Chloroethoxy)methane	UG/KG	0	0%		0	0	108	360 U	1160 U	150 U	66 U
Bis(2-Chloroethyl)ether	UG/KG	0	0%		0	0	108	360 U	1160 U	150 U	66 U
Bis(2-Chloroisopropyl)ether	UG/KG	0	0%		0	0	3			150 U	66 U
Bis(2-Ethylhexyl)phthalate	UG/KG	990	19%	50000	0	34	178	360 U	990 J	41 J	16 J
Butylbenzylphthalate	UG/KG	0	0%	50000	0	0	178	360 U	1160 U	150 U	66 U
Caprolactam	UG/KG	0	0%		0	0	99	360 U			
Carbazole	UG/KG	755	19%		0	20	108	360 U	755 J	120 J	11 J
Chrysene	UG/KG	8900	51%	400	62	91	178	255 J	3015	360	25 J
Di-n-butylphthalate	UG/KG	965	2%	8100	0	4	178	360 U	965 J	80 J	5.5 J
Di-n-octylphthalate	UG/KG	0	0%	50000	0	0	178	360 U	1160 UJ	150 U	66 U
Dibenz(a,h)anthracene	UG/KG	1665	38%	14	67	68	178	360 U	1160 UJ	84 J	4.7 J
Dibenzofuran	UG/KG	2350	16%	6200	0	28	178	360 U	195 J	21 J	5.6 J
Diethyl phthalate	UG/KG	10	1%	7100	0	1	178	360 U	1160 U	150 U	10 J
Dimethylphthalate	UG/KG	0	0%	2000	0	0	178	360 U	1160 U	150 U	66 U
Fluoranthene	UG/KG	23500	54%	50000	0	97	178	340 J	5700	790	54 J
Fluorene	UG/KG	2640	28%	50000	0	49	178	360 U	465 J	46 J	8.6 J
Hexachlorobenzene	UG/KG	0	0%	410	0	0	178	360 U	1160 U	150 U	66 U
Hexachlorobutadiene	UG/KG	0	0%		0	0	178	360 U	1160 U	150 U	66 U
Hexachlorocyclopentadiene	UG/KG	0	0%		0	0	108	360 U	1160 U	150 U	66 U
Hexachloroethane	UG/KG	0	0%		0	0	178	360 U	1160 U	150 U	66 U
Indeno(1,2,3-cd)pyrene	UG/KG	4950	47%	3200	2	84	178	201.5 J	1300 J	200	14 J
Isophorone	UG/KG	0	0%	4400	0	0	178	360 U	1160 U	150 U	66 U
N-Nitrosodiphenylamine	UG/KG	100	1%		0	1	108	360 U	1160 U	150 U	66 U
N-Nitrosodipropylamine	UG/KG	0	0%		0	0	108	360 U	1160 U	150 U	66 U
Naphthalene	UG/KG	1800	19%	13000	0	34	178	360 U	150 J	12 J	19 J
Nitrobenzene	UG/KG	0	0%	200	0	0	178	360 U	1160 U	150 U	66 U
Pentachlorophenol	UG/KG	0	0%	1000	0	0	178	905 U	2850 U	370 U	160 UJ
Phenanthrene	UG/KG	21300	51%	50000	0	90	178	300 J	3590	460	43 J
Phenol	UG/KG	0	0%	30	0	0	178	360 U	1160 U	150 U	66 U
Pyrene	UG/KG	19200	55%	50000	0	98	178	320 J	7200	550	48 J
Pyridine	UG/KG	0	0%		0	0	100				
Total Unknown PAHs as SV	MG/KG	25	100%		0	3	3			13.4	1.85
Pesticides/PCBs											
4,4'-DDD	UG/KG	740	28%	2900	0	49	178	3.6 U	36	3.4 J	3.7 U
4,4'-DDE	UG/KG	2600	37%	2100	1	65	178	3.6 U	25	80	3.7 U
4,4'-DDT	UG/KG	3700	33%	2100	1	59	178	3.6 U	25	36	3.7 U
Aldrin	UG/KG	1.2	1%	41	0	1	178	1.9 U	2.2 U	2 U	1.9 U

**Table A-2A
SURFACE SOIL SAMPLE RESULTS (0-2 ft.)
SEAD-59
SEAD-59 and SEAD-71 Phase II RI Report
Seneca Army Depot Activity**

Facility	SEAD-59	SEAD-59	SEAD-59	SEAD-59
Location ID	FD-71-CL-04/CL-59-01-F01	SB59-1	TP59-9-2	SB59-20
Matrix	SOIL	SOIL	SOIL	SOIL
Sample ID	FD-71-CL-04/CL-59-01-F01	SB59-1-08/SB59-1-04	59052/59053	59066/59107
Sample Depth to Top of Sample ⁽¹⁾	0	6	2	4
Sample Depth to Bottom of Sample ⁽¹⁾	0	8	2.5	4.5
Sample Date	38113	34385	35716	35725
QC Code	SA/DU	SA/DU	SA/DU	SA/DU
Study ID	ENSR IRM	ESI	RI PHASE 1 STEP 1	RI PHASE 1 STEP 1
Sample Round	1			

Parameter	Units	Maximum	Frequency of	NYSDEC	Number of	Number of	Number of	Value (Q)	Value (Q)	Value (Q)	Value (Q)
		Value	Detection	TAGM 4046 ⁽²⁾	Exceedances	Detects	Analyses ⁽³⁾				
Alpha-BHC	UG/KG	0	0%	110	0	0	178	1.9 U	2.2 U	2 U	1.9 U
Alpha-Chlordane	UG/KG	34	4%		0	7	178	1.9 U	2.2 U	2 U	1.9 U
Beta-BHC	UG/KG	2.4	1%	200	0	1	178	1.9 U	2.2 U	2 U	1.9 U
Delta-BHC	UG/KG	0	0%	300	0	0	178	1.9 U	2.2 U	2 U	1.9 U
Dieldrin	UG/KG	0	0%	44	0	0	178	3.6 U	4.2 U	3.8 U	3.7 U
Endosulfan I	UG/KG	16	1%	900	0	1	178	1.9 U	2.2 U	2 U	1.9 U
Endosulfan II	UG/KG	0	0%	900	0	0	178	3.6 U	4.2 U	3.8 U	3.7 U
Endosulfan sulfate	UG/KG	6.2	1%	1000	0	1	178	3.6 U	4.2 U	3.8 U	3.7 U
Endrin	UG/KG	16	2%	100	0	3	178	3.6 U	4.2 U	3.8 U	3.7 U
Endrin aldehyde	UG/KG	4.9	1%		0	2	178	3.6 U	4.2 U	3.8 U	3.7 U
Endrin ketone	UG/KG	38	2%		0	4	178	3.6 U	4.2 U	3.8 U	3.7 U
Gamma-BHC/Lindane	UG/KG	0	0%	60	0	0	178	1.9 U	2.2 U	2 U	1.9 U
Gamma-Chlordane	UG/KG	24	8%	540	0	14	178	1.9 U	2.2 U	2 U	1.9 U
Heptachlor	UG/KG	0	0%	100	0	0	178	1.9 U	2.2 U	2 U	1.9 U
Heptachlor epoxide	UG/KG	3	1%	20	0	2	178	1.9 U	2.2 U	3 J	1.9 U
Methoxychlor	UG/KG	0	0%		0	0	178	19 U	22 U	20 U	19 U
Toxaphene	UG/KG	0	0%		0	0	178	190 U	220 U	200 U	190 U
Aroclor-1016	UG/KG	0	0%		0	0	178	36.5 U	42 U	38 U	37 U
Aroclor-1221	UG/KG	0	0%		0	0	178	36.5 U	86 U	78 U	75 U
Aroclor-1232	UG/KG	0	0%		0	0	178	36.5 U	42 U	38 U	37 U
Aroclor-1242	UG/KG	0	0%		0	0	178	36.5 U	42 U	38 U	37 U
Aroclor-1248	UG/KG	0	0%		0	0	178	36.5 U	42 U	38 U	37 U
Aroclor-1254	UG/KG	0	0%	10000	0	0	178	36.5 U	42 U	38 U	37 U
Aroclor-1260	UG/KG	79	1%	10000	0	2	178	36.5 U	42 U	38 U	37 U
Metals											
Aluminum	MG/KG	18300	100%	19300	0	178	178	9910 J	13000 J	10700 J	10700
Antimony	MG/KG	424	58%	5.9	5	104	178	1.1 J	0.74 J	0.6 UJ	0.63 UJ
Arsenic	MG/KG	32.2	100%	8.2	7	178	178	5.6	4.4 J	4.5	3.9
Barium	MG/KG	304	100%	300	1	178	178	82 J	108 J	77.1	88.2
Beryllium	MG/KG	2.6	99%	1.1	2	176	178	0.51	0.58 J	0.4	0.38
Cadmium	MG/KG	3.2	86%	2.3	2	153	178	0.2 J	0.37 J	0.08 U	0.09 U
Calcium	MG/KG	214000	100%	121000	1	178	178	36000 J	83700 J	25900	44000
Chromium	MG/KG	39.3	100%	29.6	2	178	178	15.2 J	18.4 J	15.8	15.7
Cobalt	MG/KG	47.8	100%	30	2	178	178	8.5 J	7.1 J	8.9	8.3
Copper	MG/KG	305	100%	33	19	178	178	22.2 J	32.9 J	21.1	17.5
Cyanide	MG/KG	0	0%	0.35	0	0	9		0.63 U	0.71 U	0.63 UJ
Iron	MG/KG	64000	100%	36500	1	178	178	18800	18300 J	19500	19100
Lead	MG/KG	164	100%	24.8	75	178	178	14.05 J	38.4 J	29.5 J	9.3
Magnesium	MG/KG	30200	100%	21500	3	178	178	8280 J	8610 J	5940 J	9770
Manganese	MG/KG	1290	100%	1060	3	178	178	457 J	418 J	422 J	407
Mercury	MG/KG	0.95	95%	0.1	37	169	178	0.035	0.16 J	0.09	0.05 U
Nickel	MG/KG	88.3	100%	49	3	178	178	24.1 J	23 J	23.1	23.7
Potassium	MG/KG	2290	100%	2380	0	178	178	1012	2290 J	1180	1440
Selenium	MG/KG	1.5	9%	2	0	16	178	0.41 U	1 J	0.83 U	0.87 U
Silver	MG/KG	2.9	49%	0.75	62	87	178	0.68 J	0.15 U	0.23 U	0.24 U

**Table A-2A
SURFACE SOIL SAMPLE RESULTS (0-2 ft.)
SEAD-59
SEAD-59 and SEAD-71 Phase II RI Report
Seneca Army Depot Activity**

Facility	SEAD-59	SEAD-59	SEAD-59	SEAD-59
Location ID	FD-71-CL-04/CL-59-01-F01	SB59-1	TP59-9-2	SB59-20
Maxtrix	SOIL	SOIL	SOIL	SOIL
Sample ID	FD-71-CL-04/CL-59-01-F01	SB59-1-08/SB59-1-04	59052/59053	59066/59107
Sample Depth to Top of Sample ⁽¹⁾	0	6	2	4
Sample Depth to Bottom of Sample ⁽¹⁾	0	8	2.5	4.5
Sample Date	38113	34385	35716	35725
QC Code	SA/DU	SA/DU	SA/DU	SA/DU
Study ID	ENSR IRM	ESI	RI PHASE 1 STEP 1	RI PHASE 1 STEP 1
Sample Round	1			

Parameter	Units	Maximum Value	Frequency of Detection	NYSDEC TAGM 4046 ⁽²⁾	Number of Exceedances	Number of Detects	Number of Analyses ⁽³⁾	Value (Q)	Value (Q)	Value (Q)	Value (Q)
Sodium	MG/KG	4060	99%	172	86	177	178	113	353 J	89.6 U	696
Thallium	MG/KG	1.8	29%	0.7	24	51	178	0.205 U	0.27 U	1.2 U	0.89 UJ
Vanadium	MG/KG	28.5	100%	150	0	178	178	17.2 J	24.8 J	17.3	18.8
Zinc	MG/KG	341	100%	110	19	178	178	57.7	116 J	68.8 J	81.7

- Note(s):
(1) - Historical sample depths are presented (I.e. prior to 2002 TCRA)
(2) - NYSDEC Technical and Administrative Guidance Memorandum (TAGM) HWR-94-4046, Revised January 24, 1994
(3) - Sample/Duplicate pair are presented as individual samples in this table. Statistical information used Sample Duplicate pairs as a single entity and averaged result values were used in risk assessment analysis.

U = compound was not detected
J = the reported value is an estimated concentration
UJ = the compound was not detected; the associated reporting limit is approximate
R = the data was rejected in the data validating process
NJ = compound was "tentatively identified" and the associated numerical value is approximate

**Table A-2A
SURFACE SOIL SAMPLE RESULTS (0-2 ft.)
SEAD-59
SEAD-59 and SEAD-71 Phase II RI Report
Seneca Army Depot Activity**

Facility	SEAD-59	SEAD-59	SEAD-59
Location ID	FD-59-W5-6/WS-59-01-012-1	FD-59-WS-01/WS-59-03-001-3	FD-59-WS-05/WS-59-04-010-4
Maxtrix	SOIL	SOIL	SOIL
Sample ID	FD-59-W5-6/WS-59-01-012-1	FD-59-WS-01/WS-59-03-001-3	FD-59-WS-05/WS-59-04-010-4
Sample Depth to Top of Sample ⁽¹⁾	0	0	0
Sample Depth to Bottom of Sample ⁽¹⁾	0	0	0
Sample Date	38113	38113	38113
QC Code	SA/DU	SA/DU	SA/DU
Study ID	ENSR IRM	ENSR IRM	ENSR IRM
Sample Round	1	1	1

Parameter	Units	Maximum Value	Frequency of Detection	NYSDEC TAGM 4046 ⁽²⁾	Number of Exceedances	Number of Detects	Number of Analyses ⁽³⁾	Value (Q)	Value (Q)	Value (Q)
Volatile Organics										
1,1,1-Trichloroethane	UG/KG	0	0%	800	0	0	177	6 U	5.75 U	5.5 U
1,1,2,2-Tetrachloroethane	UG/KG	0	0%	600	0	0	169	6 U	5.75 U	5.5 UJ
1,1,2-Trichloro-1,2,2-Trifluoroethane	UG/KG	0	0%		0	0	168	6 U	5.75 U	5.5 UJ
1,1,2-Trichloroethane	UG/KG	0	0%		0	0	107	6 U		5.5 U
1,1-Dichloroethane	UG/KG	0	0%	200	0	0	177	6 U	5.75 U	5.5 U
1,1-Dichloroethene	UG/KG	8	2%	400	0	3	177	6 U	5.75 U	5.5 U
1,2,3-Trichloropropane	UG/KG	0	0%		0	0	70		5.75 U	
1,2,4-Trichlorobenzene	UG/KG	0	0%	3400	0	0	161	6 U	5.75 U	5.5 UJ
1,2-Dibromo-3-chloropropane	UG/KG	0	0%		0	0	91	6 U		5.5 UJ
1,2-Dibromoethane	UG/KG	0	0%		0	0	98	6 U		5.5 U
1,2-Dichlorobenzene	UG/KG	0	0%	7900	0	0	161	6 U	5.75 U	5.5 UJ
1,2-Dichloroethane	UG/KG	0	0%	100	0	0	177	6 U	5.75 U	5.5 U
1,2-Dichloroethene (total)	UG/KG	0	0%		0	0	9			
1,2-Dichloropropane	UG/KG	0	0%		0	0	107	6 U		5.5 U
1,3-Dichlorobenzene	UG/KG	0	0%	1600	0	0	161	6 U	5.75 U	5.5 UJ
1,3-Dichloropropane	UG/KG	0	0%		0	0	70		5.75 U	
1,4-Dichlorobenzene	UG/KG	0	0%	8500	0	0	161	6 U	5.75 U	5.5 UJ
Acetone	UG/KG	550	27%	200	2	47	177	44.5 NJ	23 U	5.5 U
Benzene	UG/KG	3	4%	60	0	7	177	6 U	5.75 U	5.5 U
Bromodichloromethane	UG/KG	0	0%		0	0	107	6 U		5.5 U
Bromoform	UG/KG	0	0%		0	0	107	6 U		5.5 U
Carbon disulfide	UG/KG	4	3%	2700	0	6	177	6 U	5.75 U	5.5 U
Carbon tetrachloride	UG/KG	0	0%	600	0	0	177	6 U	5.75 U	5.5 U
Chlorobenzene	UG/KG	0	0%	1700	0	0	177	6 U	5.75 U	5.5 U
Chlorodibromomethane	UG/KG	0	0%		0	0	177	6 U	5.75 U	5.5 U
Chloroethane	UG/KG	0	0%	1900	0	0	177	6 U	11.5 U	5.5 U
Chloroform	UG/KG	0	0%	300	0	0	177	6 U	5.75 U	5.5 U
Cis-1,2-Dichloroethene	UG/KG	0	0%		0	0	98	6 U		5.5 U
Cis-1,3-Dichloropropene	UG/KG	0	0%		0	0	107	6 U		5.5 U
Cyclohexane	UG/KG	3	8%		0	8	98	6 U		5.5 U
Dichlorodifluoromethane	UG/KG	0	0%		0	0	98	6 U		5.5 U
Ethyl benzene	UG/KG	4.6	1%	5500	0	2	177	6 U	4.6 J	5.5 U
Isopropylbenzene	UG/KG	0	0%		0	0	98	6 U		5.5 U
Meta/Para Xylene	UG/KG	9.4	4%		0	3	70		9.4 J	
Methyl Acetate	UG/KG	2	3%		0	3	98	6 U		5.5 U
Methyl Terbutyl Ether	UG/KG	0	0%		0	0	98	6 U		5.5 U
Methyl bromide	UG/KG	0	0%		0	0	107	6 U		5.5 U
Methyl butyl ketone	UG/KG	0	0%		0	0	107	6 U		5.5 U
Methyl chloride	UG/KG	0	0%		0	0	107	6 U		5.5 U
Methyl cyclohexane	UG/KG	5	10%		0	10	98	6 U		5.5 U
Methyl ethyl ketone	UG/KG	190	12%	300	0	22	177	4.5 J	11.5 U	5.5 U
Methyl isobutyl ketone	UG/KG	1.9	1%	1000	0	1	177	6 U	11.5 U	5.5 U
Methylene chloride	UG/KG	4.9	20%	100	0	36	178	6 U	1.5 J	5.5 U
Ortho Xylene	UG/KG	5.05	4%		0	3	70		5.05 J	

Table A-2A
SURFACE SOIL SAMPLE RESULTS (0-2 ft.)
SEAD-59
SEAD-59 and SEAD-71 Phase II RI Report
Seneca Army Depot Activity

Facility	SEAD-59	SEAD-59	SEAD-59
Location ID	FD-59-W5-6/WS-59-01-012-1	FD-59-WS-01/WS-59-03-001-3	FD-59-WS-05/WS-59-04-010-4
Maxtrix	SOIL	SOIL	SOIL
Sample ID	FD-59-W5-6/WS-59-01-012-1	FD-59-WS-01/WS-59-03-001-3	FD-59-WS-05/WS-59-04-010-4
Sample Depth to Top of Sample ⁽¹⁾	0	0	0
Sample Depth to Bottom of Sample ⁽¹⁾	0	0	0
Sample Date	38113	38113	38113
QC Code	SA/DU	SA/DU	SA/DU
Study ID	ENSR IRM	ENSR IRM	ENSR IRM
Sample Round	1	1	1

Parameter	Units	Maximum Value	Frequency of Detection	NYSDEC TAGM 4046 ⁽²⁾	Number of Exceedances	Number of Detects	Number of Analyses ⁽³⁾	Value (Q)	Value (Q)	Value (Q)
Styrene	UG/KG	0	0%		0	0	107	6 U		5.5 U
Tetrachloroethene	UG/KG	6.4	3%	1400	0	5	177	6 U	5.75 U	5.5 U
Toluene	UG/KG	8	8%	1500	0	14	177	6 U	5.7 J	5.5 U
Total BTEX	MG/KG	3.25	67%		0	2	3			
Total Xylenes	UG/KG	3	7%	1200	0	7	102	6 U		5.5 UJ
Trans-1,2-Dichloroethene	UG/KG	0	0%	300	0	0	168	6 U	5.75 U	5.5 U
Trans-1,3-Dichloropropene	UG/KG	0	0%		0	0	107	6 U		5.5 U
Trichloroethene	UG/KG	4.5	5%	700	0	8	177	6 U	5.75 U	5.5 U
Trichlorofluoromethane	UG/KG	6	1%		0	1	98	6 U		5.5 U
Vinyl chloride	UG/KG	0	0%	200	0	0	177	6 U	11.5 U	5.5 U
Semivolatile Organics										
1,1'-Biphenyl	UG/KG	254.5	2%		0	2	99	254.5 J		350 U
1,2,4-Trichlorobenzene	UG/KG	0	0%	3400	0	0	9			
1,2-Dichlorobenzene	UG/KG	0	0%	7900	0	0	9			
1,3-Dichlorobenzene	UG/KG	0	0%	1600	0	0	9			
1,4-Dichlorobenzene	UG/KG	0	0%	8500	0	0	9			
2,2'-oxybis(1-Chloropropane)	UG/KG	0	0%		0	0	105	400 U		350 U
2,4,5-Trichlorophenol	UG/KG	0	0%	100	0	0	178	1010 U	380 U	895 U
2,4,6-Trichlorophenol	UG/KG	0	0%		0	0	178	400 U	380 U	350 U
2,4-Dichlorophenol	UG/KG	0	0%	400	0	0	178	400 U	380 U	350 U
2,4-Dimethylphenol	UG/KG	0	0%		0	0	108	400 U		350 U
2,4-Dinitrophenol	UG/KG	0	0%	200	0	0	178	1010 UJ	1950 U	895 U
2,4-Dinitrotoluene	UG/KG	0	0%		0	0	178	400 U	380 U	350 U
2,6-Dinitrotoluene	UG/KG	0	0%	1000	0	0	178	400 U	380 U	350 U
2-Chloronaphthalene	UG/KG	0	0%		0	0	108	400 U		350 U
2-Chlorophenol	UG/KG	0	0%	800	0	0	178	400 U	380 U	350 U
2-Methylnaphthalene	UG/KG	1295	19%	36400	0	34	178	252.5 J	380 U	225 J
2-Methylphenol	UG/KG	0	0%	100	0	0	178	400 U	380 U	350 U
2-Nitroaniline	UG/KG	0	0%	430	0	0	178	1010 U	1950 U	895 U
2-Nitrophenol	UG/KG	0	0%	330	0	0	178	400 U	380 U	350 U
3,3'-Dichlorobenzidine	UG/KG	0	0%		0	0	178	400 UJ	380 U	350 U
3-Nitroaniline	UG/KG	0	0%	500	0	0	178	1010 U	1950 U	895 U
4,6-Dinitro-2-methylphenol	UG/KG	0	0%		0	0	108	1010 U		895 U
4-Bromophenyl phenyl ether	UG/KG	0	0%		0	0	108	400 U		350 U
4-Chloro-3-methylphenol	UG/KG	0	0%	240	0	0	178	400 U	380 U	350 U
4-Chloroaniline	UG/KG	1200	1%	220	1	2	178	400 UJ	380 U	350 U
4-Chlorophenyl phenyl ether	UG/KG	0	0%		0	0	108	400 U		350 U
4-Methylphenol	UG/KG	150	3%	900	0	5	178	400 U	380 U	350 U
4-Nitroaniline	UG/KG	0	0%		0	0	108	1010 U		895 U
4-Nitrophenol	UG/KG	0	0%	100	0	0	178	1010 U	1950 U	895 U
Acenaphthene	UG/KG	2680	24%	50000	0	42	178	445 J	380 U	325 J
Acenaphthylene	UG/KG	1700	37%	41000	0	66	178	680 J	380 U	215.5 J
Acetophenone	UG/KG	0	0%		0	0	99	400 U		350 U
Aniline	UG/KG	0	0%		0	0	70		380 U	
Anthracene	UG/KG	4395	43%	50000	0	77	178	1580 J	380 U	305 J

**Table A-2A
SURFACE SOIL SAMPLE RESULTS (0-2 ft.)
SEAD-59
SEAD-59 and SEAD-71 Phase II RI Report
Seneca Army Depot Activity**

Facility	SEAD-59	SEAD-59	SEAD-59
Location ID	FD-59-W5-6/WS-59-01-012-1	FD-59-WS-01/WS-59-03-001-3	FD-59-WS-05/WS-59-04-010-4
Maxtrix	SOIL	SOIL	SOIL
Sample ID	FD-59-W5-6/WS-59-01-012-1	FD-59-WS-01/WS-59-03-001-3	FD-59-WS-05/WS-59-04-010-4
Sample Depth to Top of Sample ⁽¹⁾	0	0	0
Sample Depth to Bottom of Sample ⁽¹⁾	0	0	0
Sample Date	38113	38113	38113
QC Code	SA/DU	SA/DU	SA/DU
Study ID	ENSR IRM	ENSR IRM	ENSR IRM
Sample Round	1	1	1

Parameter	Units	Maximum	Frequency of	NYSDEC	Number of	Number of	Number of	Value (Q)	Value (Q)	Value (Q)
		Value	Detection	TAGM 4046 ⁽²⁾	Exceedances	Detects	Analyses ⁽³⁾			
Atrazine	UG/KG	120	1%		0	1	99	400 U		350 U
Benzaldehyde	UG/KG	50	1%		0	1	99	400 U		350 U
Benzo(a)anthracene	UG/KG	8900	51%	224	72	90	178	4850 J	67.5 J	585.5 J
Benzo(a)pyrene	UG/KG	8050	51%	61	84	91	178	5250 J	71.5 J	527.5 J
Benzo(b)fluoranthene	UG/KG	6800	52%	1100	40	92	178	5450 J	66.5 J	643 J
Benzo(ghi)perylene	UG/KG	5200	46%	50000	0	82	178	1700 J	214.5 J	257 J
Benzo(k)fluoranthene	UG/KG	7350	49%	1100	35	88	178	3140 J	60 J	250 J
Benzoic Acid	UG/KG	0	0%	2700	0	0	70		1950 U	
Bis(2-Chloroethoxy)methane	UG/KG	0	0%		0	0	108	400 U		350 U
Bis(2-Chloroethyl)ether	UG/KG	0	0%		0	0	108	400 U		350 U
Bis(2-Chloroisopropyl)ether	UG/KG	0	0%		0	0	3			
Bis(2-Ethylhexyl)phthalate	UG/KG	990	19%	50000	0	34	178	290 J	380 U	44.5 J
Butylbenzylphthalate	UG/KG	0	0%	50000	0	0	178	400 UJ	380 U	350 U
Caprolactam	UG/KG	0	0%		0	0	99	400 U		350 U
Carbazole	UG/KG	755	19%		0	20	108	245 J		330 J
Chrysene	UG/KG	8900	51%	400	62	91	178	4750 J	79.5 J	528 J
Di-n-butylphthalate	UG/KG	965	2%	8100	0	4	178	400 U	380 U	350 U
Di-n-octylphthalate	UG/KG	0	0%	50000	0	0	178	400 UJ	380 U	350 U
Dibenz(a,h)anthracene	UG/KG	1665	38%	14	67	68	178	710 J	380 U	240 J
Dibenzofuran	UG/KG	2350	16%	6200	0	28	178	258 J	380 U	270 J
Diethyl phthalate	UG/KG	10	1%	7100	0	1	178	400 U	380 U	350 U
Dimethylphthalate	UG/KG	0	0%	2000	0	0	178	400 U	380 U	350 U
Fluoranthene	UG/KG	23500	54%	50000	0	97	178	8150 J	140 J	1165 J
Fluorene	UG/KG	2640	28%	50000	0	49	178	720 J	380 U	320 J
Hexachlorobenzene	UG/KG	0	0%	410	0	0	178	400 U	380 U	350 U
Hexachlorobutadiene	UG/KG	0	0%		0	0	178	400 U	380 U	350 U
Hexachlorocyclopentadiene	UG/KG	0	0%		0	0	108	400 U		350 U
Hexachloroethane	UG/KG	0	0%		0	0	178	400 U	380 U	350 U
Indeno(1,2,3-cd)pyrene	UG/KG	4950	47%	3200	2	84	178	1850 J	212.5 J	283 J
Isophorone	UG/KG	0	0%	4400	0	0	178	400 U	380 U	350 U
N-Nitrosodiphenylamine	UG/KG	100	1%		0	1	108	400 U		350 U
N-Nitrosodipropylamine	UG/KG	0	0%		0	0	108	400 U		350 U
Naphthalene	UG/KG	1800	19%	13000	0	34	178	250 J	380 U	380 J
Nitrobenzene	UG/KG	0	0%	200	0	0	178	400 U	380 U	350 U
Pentachlorophenol	UG/KG	0	0%	1000	0	0	178	1010 U	1950 U	895 U
Phenanthrene	UG/KG	21300	51%	50000	0	90	178	4200 J	85.5 J	1099.5 J
Phenol	UG/KG	0	0%	30	0	0	178	400 U	380 U	350 U
Pyrene	UG/KG	19200	55%	50000	0	98	178	8200 J	120 J	1010 J
Pyridine	UG/KG	0	0%		0	0	100		1950 U	
Total Unknown PAHs as SV	MG/KG	25	100%		0	3	3			
Pesticides/PCBs										
4,4'-DDD	UG/KG	740	28%	2900	0	49	178	9.15 J	19 U	3.55 UJ
4,4'-DDE	UG/KG	2600	37%	2100	1	65	178	27 J	19 U	6.7 J
4,4'-DDT	UG/KG	3700	33%	2100	1	59	178	9.45 J	19 U	11.2 J
Aldrin	UG/KG	1.2	1%	41	0	1	178	2.05 U	9.8 U	1.85 U

**Table A-2A
SURFACE SOIL SAMPLE RESULTS (0-2 ft.)
SEAD-59
SEAD-59 and SEAD-71 Phase II RI Report
Seneca Army Depot Activity**

Facility	SEAD-59	SEAD-59	SEAD-59
Location ID	FD-59-W5-6/WS-59-01-012-1	FD-59-WS-01/WS-59-03-001-3	FD-59-WS-05/WS-59-04-010-4
Maxtrix	SOIL	SOIL	SOIL
Sample ID	FD-59-W5-6/WS-59-01-012-1	FD-59-WS-01/WS-59-03-001-3	FD-59-WS-05/WS-59-04-010-4
Sample Depth to Top of Sample ⁽¹⁾	0	0	0
Sample Depth to Bottom of Sample ⁽¹⁾	0	0	0
Sample Date	38113	38113	38113
QC Code	SA/DU	SA/DU	SA/DU
Study ID	ENSR IRM	ENSR IRM	ENSR IRM
Sample Round	1	1	1

Parameter	Units	Maximum	Frequency of	NYSDEC	Number of	Number of	Number of	Value (Q)	Value (Q)	Value (Q)
		Value	Detection	TAGM 4046 ⁽²⁾	Exceedances	Detects	Analyses ⁽³⁾			
Alpha-BHC	UG/KG	0	0%	110	0	0	178	2.05 U	9.8 U	1.85 U
Alpha-Chlordane	UG/KG	34	4%		0	7	178	2.05 U	9.8 U	1.85 UJ
Beta-BHC	UG/KG	2.4	1%	200	0	1	178	2.05 U	9.8 U	1.85 U
Delta-BHC	UG/KG	0	0%	300	0	0	178	2.05 U	9.8 U	1.85 U
Dieldrin	UG/KG	0	0%	44	0	0	178	4 U	19 U	3.55 U
Endosulfan I	UG/KG	16	1%	900	0	1	178	2.05 U	9.8 U	1.85 U
Endosulfan II	UG/KG	0	0%	900	0	0	178	4 U	19 U	3.55 U
Endosulfan sulfate	UG/KG	6.2	1%	1000	0	1	178	4 U	19 U	3.55 U
Endrin	UG/KG	16	2%	100	0	3	178	4 U	19 U	3.55 U
Endrin aldehyde	UG/KG	4.9	1%		0	2	178	4.9 J	19 U	3.55 U
Endrin ketone	UG/KG	38	2%		0	4	178	8.15 J	19 U	3.55 U
Gamma-BHC/Lindane	UG/KG	0	0%	60	0	0	178	2.05 U	9.8 U	1.85 U
Gamma-Chlordane	UG/KG	24	8%	540	0	14	178	2.05 U	9.8 U	1.85 UJ
Heptachlor	UG/KG	0	0%	100	0	0	178	2.05 U	9.8 U	1.85 U
Heptachlor epoxide	UG/KG	3	1%	20	0	2	178	2.05 U	9.8 U	1.85 U
Methoxychlor	UG/KG	0	0%		0	0	178	20.5 U	98 U	18.5 UJ
Toxaphene	UG/KG	0	0%		0	0	178	205 U	190 U	185 U
Aroclor-1016	UG/KG	0	0%		0	0	178	40.5 U	38 U	36 U
Aroclor-1221	UG/KG	0	0%		0	0	178	40.5 U	38 U	36 U
Aroclor-1232	UG/KG	0	0%		0	0	178	40.5 U	38 U	36 U
Aroclor-1242	UG/KG	0	0%		0	0	178	40.5 U	38 U	36 U
Aroclor-1248	UG/KG	0	0%		0	0	178	40.5 U	38 U	36 U
Aroclor-1254	UG/KG	0	0%	10000	0	0	178	40.5 U	38 U	36 U
Aroclor-1260	UG/KG	79	1%	10000	0	2	178	40.5 U	38 U	36 U
Metals										
Aluminum	MG/KG	18300	100%	19300	0	178	178	11650 J	10750	9595 J
Antimony	MG/KG	424	58%	5.9	5	104	178	1.75 J	3.4 UJ	1.7 J
Arsenic	MG/KG	32.2	100%	8.2	7	178	178	6.15 J	4.7	5.55 J
Barium	MG/KG	304	100%	300	1	178	178	98 J	94.35	63.7 J
Beryllium	MG/KG	2.6	99%	1.1	2	176	178	0.61	0.255	0.485
Cadmium	MG/KG	3.2	86%	2.3	2	153	178	0.51	0.28 U	0.315 J
Calcium	MG/KG	214000	100%	121000	1	178	178	43400 J	59250	57000 J
Chromium	MG/KG	39.3	100%	29.6	2	178	178	18.85 J	16.95	14.65 J
Cobalt	MG/KG	47.8	100%	30	2	178	178	10.2 J	7.9	8.65 J
Copper	MG/KG	305	100%	33	19	178	178	25.25 J	21	22.85 J
Cyanide	MG/KG	0	0%	0.35	0	0	9			
Iron	MG/KG	64000	100%	36500	1	178	178	22300 J	20700	21050
Lead	MG/KG	164	100%	24.8	75	178	178	28.3 J	17.7 J	15.4 J
Magnesium	MG/KG	30200	100%	21500	3	178	178	6685 J	8990	9420 J
Manganese	MG/KG	1290	100%	1060	3	178	178	575.5 J	403	449.5 J
Mercury	MG/KG	0.95	95%	0.1	37	169	178	0.065	0.055	0.16 J
Nickel	MG/KG	88.3	100%	49	3	178	178	30.55 J	25	23.7 J
Potassium	MG/KG	2290	100%	2380	0	178	178	1285 J	1065	1241.5 J
Selenium	MG/KG	1.5	9%	2	0	16	178	0.435 U	0.565 U	0.405 U
Silver	MG/KG	2.9	49%	0.75	62	87	178	0.67 J	0.565 U	0.615 J

Table A-2A
SURFACE SOIL SAMPLE RESULTS (0-2 ft.)
SEAD-59
SEAD-59 and SEAD-71 Phase II RI Report
Seneca Army Depot Activity

Facility	SEAD-59	SEAD-59	SEAD-59
Location ID	FD-59-W5-6/WS-59-01-012-1	FD-59-WS-01/WS-59-03-001-3	FD-59-WS-05/WS-59-04-010-4
Maxtrix	SOIL	SOIL	SOIL
Sample ID	FD-59-W5-6/WS-59-01-012-1	FD-59-WS-01/WS-59-03-001-3	FD-59-WS-05/WS-59-04-010-4
Sample Depth to Top of Sample ⁽¹⁾	0	0	0
Sample Depth to Bottom of Sample ⁽¹⁾	0	0	0
Sample Date	38113	38113	38113
QC Code	SA/DU	SA/DU	SA/DU
Study ID	ENSR IRM	ENSR IRM	ENSR IRM
Sample Round	1	1	1

Parameter	Units	Maximum Value	Frequency of Detection	NYSDEC TAGM 4046 ⁽²⁾	Number of Exceedances	Number of Detects	Number of Analyses ⁽³⁾	Value (Q)	Value (Q)	Value (Q)
Sodium	MG/KG	4060	99%	172	86	177	178	170.5 J	107	126 J
Thallium	MG/KG	1.8	29%	0.7	24	51	178	0.22 U	0.58 J	0.2 U
Vanadium	MG/KG	28.5	100%	150	0	178	178	20.35 J	18.05	16.65 J
Zinc	MG/KG	341	100%	110	19	178	178	74.6 J	76.85 J	63.1 J

Note(s):

(1) - Historical sample depths are presented (I.e. prior to 2002 TCRA)

(2) - NYSDEC Technical and Administrative Guidance Memorandum (TAGM) HWR-94-4046, Revised January 24, 1994

(3) - Sample/Duplicate pair are presented as individual samples in this table. Statistical information used Sample Duplicate pairs as a single entity and averaged result values were used in risk assessment analysis.

U = compound was not detected

J = the reported value is an estimated concentration

UJ = the compound was not detected; the associated reporting limit is approximate

R = the data was rejected in the data validating process

NJ = compound was "tentatively identified" and the associated numerical value is approximate

**Table A-2A
SURFACE SOIL SAMPLE RESULTS (0-2 ft.)
SEAD-59
SEAD-59 and SEAD-71 Phase II RI Report
Seneca Army Depot Activity**

Facility	SEAD-59	SEAD-59
Location ID	FD-59-WS-07/WS-59-01-015-13	FD-59-WS-8/WS-59-01-016-15
Maxtrix	SOIL	SOIL
Sample ID	FD-59-WS-07/WS-59-01-015-13	FD-59-WS-8/WS-59-01-016-15
Sample Depth to Top of Sample ⁽¹⁾	0	0
Sample Depth to Bottom of Sample ⁽¹⁾	0	0
Sample Date	38113	38113
QC Code	SA/DU	SA/DU
Study ID	ENSR IRM	ENSR IRM
Sample Round	1	1

Parameter	Units	Maximum Value	Frequency of Detection	NYSDEC TAGM 4046 ⁽²⁾	Number of Exceedances	Number of Detects	Number of Analyses ⁽³⁾	Value (Q)	Value (Q)
Volatile Organics									
1,1,1-Trichloroethane	UG/KG	0	0%	800	0	0	177	5.85 U	5.75 U
1,1,2,2-Tetrachloroethane	UG/KG	0	0%	600	0	0	169	5.85 U	5.75 UJ
1,1,2-Trichloro-1,2,2-Trifluoroethane	UG/KG	0	0%		0	0	168	5.85 U	5.75 UJ
1,1,2-Trichloroethane	UG/KG	0	0%		0	0	107		
1,1-Dichloroethane	UG/KG	0	0%	200	0	0	177	5.85 U	5.75 U
1,1-Dichloroethene	UG/KG	8	2%	400	0	3	177	5.85 U	5.75 U
1,2,3-Trichloropropane	UG/KG	0	0%		0	0	70	5.85 U	5.75 U
1,2,4-Trichlorobenzene	UG/KG	0	0%	3400	0	0	161	5.85 U	5.75 U
1,2-Dibromo-3-chloropropane	UG/KG	0	0%		0	0	91		
1,2-Dibromoethane	UG/KG	0	0%		0	0	98		
1,2-Dichlorobenzene	UG/KG	0	0%	7900	0	0	161	5.85 U	5.75 U
1,2-Dichloroethane	UG/KG	0	0%	100	0	0	177	5.85 U	5.75 U
1,2-Dichloroethene (total)	UG/KG	0	0%		0	0	9		
1,2-Dichloropropane	UG/KG	0	0%		0	0	107		
1,3-Dichlorobenzene	UG/KG	0	0%	1600	0	0	161	5.85 U	5.75 U
1,3-Dichloropropane	UG/KG	0	0%		0	0	70	5.85 U	5.75 U
1,4-Dichlorobenzene	UG/KG	0	0%	8500	0	0	161	5.85 U	5.75 U
Acetone	UG/KG	550	27%	200	2	47	177	23.5 U	23 U
Benzene	UG/KG	3	4%	60	0	7	177	5.85 U	5.75 U
Bromodichloromethane	UG/KG	0	0%		0	0	107		
Bromoform	UG/KG	0	0%		0	0	107		
Carbon disulfide	UG/KG	4	3%	2700	0	6	177	5.85 U	5.75 U
Carbon tetrachloride	UG/KG	0	0%	600	0	0	177	5.85 U	5.75 U
Chlorobenzene	UG/KG	0	0%	1700	0	0	177	5.85 U	5.75 U
Chlorodibromomethane	UG/KG	0	0%		0	0	177	5.85 U	5.75 U
Chloroethane	UG/KG	0	0%	1900	0	0	177	12 U	11.5 U
Chloroform	UG/KG	0	0%	300	0	0	177	5.85 U	5.75 U
Cis-1,2-Dichloroethene	UG/KG	0	0%		0	0	98		
Cis-1,3-Dichloropropene	UG/KG	0	0%		0	0	107		
Cyclohexane	UG/KG	3	8%		0	8	98		
Dichlorodifluoromethane	UG/KG	0	0%		0	0	98		
Ethyl benzene	UG/KG	4.6	1%	5500	0	2	177	5.85 U	5.75 U
Isopropylbenzene	UG/KG	0	0%		0	0	98		
Meta/Para Xylene	UG/KG	9.4	4%		0	3	70	5.85 U	5.75 U
Methyl Acetate	UG/KG	2	3%		0	3	98		
Methyl Tertbutyl Ether	UG/KG	0	0%		0	0	98		
Methyl bromide	UG/KG	0	0%		0	0	107		
Methyl butyl ketone	UG/KG	0	0%		0	0	107		
Methyl chloride	UG/KG	0	0%		0	0	107		
Methyl cyclohexane	UG/KG	5	10%		0	10	98		
Methyl ethyl ketone	UG/KG	190	12%	300	0	22	177	12 U	11.5 U
Methyl isobutyl ketone	UG/KG	1.9	1%	1000	0	1	177	12 U	11.5 U
Methylene chloride	UG/KG	4.9	20%	100	0	36	178	5.85 U	5.75 U
Ortho Xylene	UG/KG	5.05	4%		0	3	70	5.85 U	5.75 U

**Table A-2A
SURFACE SOIL SAMPLE RESULTS (0-2 ft.)
SEAD-59
SEAD-59 and SEAD-71 Phase II RI Report
Seneca Army Depot Activity**

Facility	SEAD-59	SEAD-59
Location ID	FD-59-WS-07/WS-59-01-015-13	FD-59-WS-8/WS-59-01-016-15
Maxtrix	SOIL	SOIL
Sample ID	FD-59-WS-07/WS-59-01-015-13	FD-59-WS-8/WS-59-01-016-15
Sample Depth to Top of Sample ⁽¹⁾	0	0
Sample Depth to Bottom of Sample ⁽¹⁾	0	0
Sample Date	38113	38113
QC Code	SA/DU	SA/DU
Study ID	ENSR IRM	ENSR IRM
Sample Round	1	1

Parameter	Units	Maximum Value	Frequency of Detection	NYSDEC TAGM 4046 ⁽²⁾	Number of Exceedances	Number of Detects	Number of Analyses ⁽³⁾	Value (Q)	Value (Q)
Styrene	UG/KG	0	0%		0	0	107		
Tetrachloroethene	UG/KG	6.4	3%	1400	0	5	177	5.85 U	4 J
Toluene	UG/KG	8	8%	1500	0	14	177	5.85 U	5.75 U
Total BTEX	MG/KG	3.25	67%		0	2	3		
Total Xylenes	UG/KG	3	7%	1200	0	7	102		
Trans-1,2-Dichloroethene	UG/KG	0	0%	300	0	0	168	5.85 U	5.75 U
Trans-1,3-Dichloropropene	UG/KG	0	0%		0	0	107		
Trichloroethene	UG/KG	4.5	5%	700	0	8	177	5.85 U	5.75 U
Trichlorofluoromethane	UG/KG	6	1%		0	1	98		
Vinyl chloride	UG/KG	0	0%	200	0	0	177	12 U	11.5 U
Semivolatile Organics									
1,1'-Biphenyl	UG/KG	254.5	2%		0	2	99		
1,2,4-Trichlorobenzene	UG/KG	0	0%	3400	0	0	9		
1,2-Dichlorobenzene	UG/KG	0	0%	7900	0	0	9		
1,3-Dichlorobenzene	UG/KG	0	0%	1600	0	0	9		
1,4-Dichlorobenzene	UG/KG	0	0%	8500	0	0	9		
2,2'-oxybis(1-Chloropropane)	UG/KG	0	0%		0	0	105		
2,4,5-Trichlorophenol	UG/KG	0	0%	100	0	0	178	2900 U	1150 U
2,4,6-Trichlorophenol	UG/KG	0	0%		0	0	178	2900 U	1150 U
2,4-Dichlorophenol	UG/KG	0	0%	400	0	0	178	2900 U	1150 U
2,4-Dimethylphenol	UG/KG	0	0%		0	0	108		
2,4-Dinitrophenol	UG/KG	0	0%	200	0	0	178	15000 U	5900 UJ
2,4-Dinitrotoluene	UG/KG	0	0%		0	0	178	2900 U	1150 U
2,6-Dinitrotoluene	UG/KG	0	0%	1000	0	0	178	2900 U	1150 U
2-Chloronaphthalene	UG/KG	0	0%		0	0	108		
2-Chlorophenol	UG/KG	0	0%	800	0	0	178	2900 U	1150 U
2-Methylnaphthalene	UG/KG	1295	19%	36400	0	34	178	1295 J	675 J
2-Methylphenol	UG/KG	0	0%	100	0	0	178	2900 U	1150 U
2-Nitroaniline	UG/KG	0	0%	430	0	0	178	15000 U	5900 U
2-Nitrophenol	UG/KG	0	0%	330	0	0	178	2900 U	1150 U
3,3'-Dichlorobenzidine	UG/KG	0	0%		0	0	178	2900 U	1150 U
3-Nitroaniline	UG/KG	0	0%	500	0	0	178	15000 U	5900 U
4,6-Dinitro-2-methylphenol	UG/KG	0	0%		0	0	108		
4-Bromophenyl phenyl ether	UG/KG	0	0%		0	0	108		
4-Chloro-3-methylphenol	UG/KG	0	0%	240	0	0	178	2900 U	1150 U
4-Chloroaniline	UG/KG	1200	1%	220	1	2	178	2900 U	1150 U
4-Chlorophenyl phenyl ether	UG/KG	0	0%		0	0	108		
4-Methylphenol	UG/KG	150	3%	900	0	5	178	2900 U	1150 U
4-Nitroaniline	UG/KG	0	0%		0	0	108		
4-Nitrophenol	UG/KG	0	0%	100	0	0	178	15000 U	5900 U
Acenaphthene	UG/KG	2680	24%	50000	0	42	178	2680 J	705 J
Acenaphthylene	UG/KG	1700	37%	41000	0	66	178	555 J	455 J
Acetophenone	UG/KG	0	0%		0	0	99		
Aniline	UG/KG	0	0%		0	0	70	2900 U	1150 U
Anthracene	UG/KG	4395	43%	50000	0	77	178	4395 J	530 J

Table A-2A
SURFACE SOIL SAMPLE RESULTS (0-2 ft.)
SEAD-59
SEAD-59 and SEAD-71 Phase II RI Report
Seneca Army Depot Activity

Facility	SEAD-59	SEAD-59
Location ID	FD-59-WS-07/WS-59-01-015-13	FD-59-WS-8/WS-59-01-016-15
Maxtrix	SOIL	SOIL
Sample ID	FD-59-WS-07/WS-59-01-015-13	FD-59-WS-8/WS-59-01-016-15
Sample Depth to Top of Sample ⁽¹⁾	0	0
Sample Depth to Bottom of Sample ⁽¹⁾	0	0
Sample Date	38113	38113
QC Code	SA/DU	SA/DU
Study ID	ENSR IRM	ENSR IRM
Sample Round	1	1

Parameter	Units	Maximum Value	Frequency of Detection	NYSDEC TAGM 4046 ⁽²⁾	Number of Exceedances	Number of Detects	Number of Analyses ⁽³⁾	Value (Q)	Value (Q)
Atrazine	UG/KG	120	1%		0	1	99		
Benzaldehyde	UG/KG	50	1%		0	1	99		
Benzo(a)anthracene	UG/KG	8900	51%	224	72	90	178	8900 J	1640 J
Benzo(a)pyrene	UG/KG	8050	51%	61	84	91	178	8050 J	1735 J
Benzo(b)fluoranthene	UG/KG	6800	52%	1100	40	92	178	6800 J	1335 J
Benzo(ghi)perylene	UG/KG	5200	46%	50000	0	82	178	5200 J	1195 J
Benzo(k)fluoranthene	UG/KG	7350	49%	1100	35	88	178	7350 J	1410 J
Benzoic Acid	UG/KG	0	0%	2700	0	0	70	15000 UJ	5900 U
Bis(2-Chloroethoxy)methane	UG/KG	0	0%		0	0	108		
Bis(2-Chloroethyl)ether	UG/KG	0	0%		0	0	108		
Bis(2-Chloroisopropyl)ether	UG/KG	0	0%		0	0	3		
Bis(2-Ethylhexyl)phthalate	UG/KG	990	19%	50000	0	34	178	2900 U	1150 U
Butylbenzylphthalate	UG/KG	0	0%	50000	0	0	178	2900 U	1150 U
Caprolactam	UG/KG	0	0%		0	0	99		
Carbazole	UG/KG	755	19%		0	20	108		
Chrysene	UG/KG	8900	51%	400	62	91	178	8900 J	1630 J
Di-n-butylphthalate	UG/KG	965	2%	8100	0	4	178	2900 U	1150 U
Di-n-octylphthalate	UG/KG	0	0%	50000	0	0	178	2900 U	1150 U
Dibenz(a,h)anthracene	UG/KG	1665	38%	14	67	68	178	1665 J	360 J
Dibenzofuran	UG/KG	2350	16%	6200	0	28	178	2350 J	680 J
Diethyl phthalate	UG/KG	10	1%	7100	0	1	178	2900 U	1150 U
Dimethylphthalate	UG/KG	0	0%	2000	0	0	178	2900 U	1150 U
Fluoranthene	UG/KG	23500	54%	50000	0	97	178	23500 J	3150
Fluorene	UG/KG	2640	28%	50000	0	49	178	2640 J	760 J
Hexachlorobenzene	UG/KG	0	0%	410	0	0	178	2900 U	1150 U
Hexachlorobutadiene	UG/KG	0	0%		0	0	178	2900 U	1150 U
Hexachlorocyclopentadiene	UG/KG	0	0%		0	0	108		
Hexachloroethane	UG/KG	0	0%		0	0	178	2900 U	1150 U
Indeno(1,2,3-cd)pyrene	UG/KG	4950	47%	3200	2	84	178	4950 J	1065 J
Isophorone	UG/KG	0	0%	4400	0	0	178	2900 U	1150 U
N-Nitrosodiphenylamine	UG/KG	100	1%		0	1	108		
N-Nitrosodipropylamine	UG/KG	0	0%		0	0	108		
Naphthalene	UG/KG	1800	19%	13000	0	34	178	1800 J	705 J
Nitrobenzene	UG/KG	0	0%	200	0	0	178	2900 U	1150 U
Pentachlorophenol	UG/KG	0	0%	1000	0	0	178	15000 U	5900 U
Phenanthrene	UG/KG	21300	51%	50000	0	90	178	21300 J	1570 J
Phenol	UG/KG	0	0%	30	0	0	178	2900 U	1150 U
Pyrene	UG/KG	19200	55%	50000	0	98	178	19200 J	2600 J
Pyridine	UG/KG	0	0%		0	0	100	15000 U	5900 U
Total Unknown PAHs as SV	MG/KG	25	100%		0	3	3		
Pesticides/PCBs									
4,4'-DDD	UG/KG	740	28%	2900	0	49	178	35 J	95.5 U
4,4'-DDE	UG/KG	2600	37%	2100	1	65	178	24.5 J	95.5 U
4,4'-DDT	UG/KG	3700	33%	2100	1	59	178	37.5 J	95.5 U
Aldrin	UG/KG	1.2	1%	41	0	1	178	10 U	49 U

**Table A-2A
SURFACE SOIL SAMPLE RESULTS (0-2 ft.)
SEAD-59
SEAD-59 and SEAD-71 Phase II RI Report
Seneca Army Depot Activity**

Facility	SEAD-59	SEAD-59
Location ID	FD-59-WS-07/WS-59-01-015-13	FD-59-WS-8/WS-59-01-016-15
Maxtrix	SOIL	SOIL
Sample ID	FD-59-WS-07/WS-59-01-015-13	FD-59-WS-8/WS-59-01-016-15
Sample Depth to Top of Sample ⁽¹⁾	0	0
Sample Depth to Bottom of Sample ⁽¹⁾	0	0
Sample Date	38113	38113
QC Code	SA/DU	SA/DU
Study ID	ENSR IRM	ENSR IRM
Sample Round	1	1

Parameter	Units	Maximum Value	Frequency of Detection	NYSDEC TAGM 4046 ⁽²⁾	Number of Exceedances	Number of Detects	Number of Analyses ⁽³⁾	Value (Q)	Value (Q)
Alpha-BHC	UG/KG	0	0%	110	0	0	178	10 U	49 U
Alpha-Chlordane	UG/KG	34	4%		0	7	178	10 U	49 U
Beta-BHC	UG/KG	2.4	1%	200	0	1	178	10 U	49 U
Delta-BHC	UG/KG	0	0%	300	0	0	178	10 U	49 U
Dieldrin	UG/KG	0	0%	44	0	0	178	19 U	95.5 U
Endosulfan I	UG/KG	16	1%	900	0	1	178	10 U	49 U
Endosulfan II	UG/KG	0	0%	900	0	0	178	19 U	95.5 U
Endosulfan sulfate	UG/KG	6.2	1%	1000	0	1	178	19 U	95.5 U
Endrin	UG/KG	16	2%	100	0	3	178	19 U	95.5 U
Endrin aldehyde	UG/KG	4.9	1%		0	2	178	19 U	95.5 U
Endrin ketone	UG/KG	38	2%		0	4	178	19 U	95.5 U
Gamma-BHC/Lindane	UG/KG	0	0%	60	0	0	178	10 U	49 U
Gamma-Chlordane	UG/KG	24	8%	540	0	14	178	10 U	49 U
Heptachlor	UG/KG	0	0%	100	0	0	178	10 U	49 U
Heptachlor epoxide	UG/KG	3	1%	20	0	2	178	10 U	49 U
Methoxychlor	UG/KG	0	0%		0	0	178	99.5 U	490 U
Toxaphene	UG/KG	0	0%		0	0	178	190 U	955 U
Aroclor-1016	UG/KG	0	0%		0	0	178	39 U	38 U
Aroclor-1221	UG/KG	0	0%		0	0	178	39 U	38 U
Aroclor-1232	UG/KG	0	0%		0	0	178	39 U	38 U
Aroclor-1242	UG/KG	0	0%		0	0	178	39 U	38 U
Aroclor-1248	UG/KG	0	0%		0	0	178	39 U	38 U
Aroclor-1254	UG/KG	0	0%	10000	0	0	178	39 U	38 U
Aroclor-1260	UG/KG	79	1%	10000	0	2	178	39 U	38 U
Metals									
Aluminum	MG/KG	18300	100%	19300	0	178	178	10750	10500
Antimony	MG/KG	424	58%	5.9	5	104	178	8.9 J	3.45 UJ
Arsenic	MG/KG	32.2	100%	8.2	7	178	178	5.1 J	4.3
Barium	MG/KG	304	100%	300	1	178	178	103.4	83.15
Beryllium	MG/KG	2.6	99%	1.1	2	176	178	0.43	0.285
Cadmium	MG/KG	3.2	86%	2.3	2	153	178	0.385 J	0.64
Calcium	MG/KG	214000	100%	121000	1	178	178	39250	64650 J
Chromium	MG/KG	39.3	100%	29.6	2	178	178	19.25 J	16.95
Cobalt	MG/KG	47.8	100%	30	2	178	178	10.3	9.4
Copper	MG/KG	305	100%	33	19	178	178	32.85 J	23.25 J
Cyanide	MG/KG	0	0%	0.35	0	0	9		
Iron	MG/KG	64000	100%	36500	1	178	178	22100	19050
Lead	MG/KG	164	100%	24.8	75	178	178	46.85 J	40 J
Magnesium	MG/KG	30200	100%	21500	3	178	178	7675 J	8205
Manganese	MG/KG	1290	100%	1060	3	178	178	700 J	465.5
Mercury	MG/KG	0.95	95%	0.1	37	169	178	0.055	0.075
Nickel	MG/KG	88.3	100%	49	3	178	178	30.05 J	24.8
Potassium	MG/KG	2290	100%	2380	0	178	178	1145	1170
Selenium	MG/KG	1.5	9%	2	0	16	178	1.15 UJ	0.57 U
Silver	MG/KG	2.9	49%	0.75	62	87	178	0.57 U	0.6 J

**Table A-2A
SURFACE SOIL SAMPLE RESULTS (0-2 ft.)
SEAD-59
SEAD-59 and SEAD-71 Phase II RI Report
Seneca Army Depot Activity**

	SEAD-59	SEAD-59
Facility		
Location ID	FD-59-WS-07/WS-59-01-015-13	FD-59-WS-8/WS-59-01-016-15
Maxtrix	SOIL	SOIL
Sample ID	FD-59-WS-07/WS-59-01-015-13	FD-59-WS-8/WS-59-01-016-15
Sample Depth to Top of Sample ⁽¹⁾	0	0
Sample Depth to Bottom of Sample ⁽¹⁾	0	0
Sample Date	38113	38113
QC Code	SA/DU	SA/DU
Study ID	ENSR IRM	ENSR IRM
Sample Round	1	1

Parameter	Units	Maximum Value	Frequency of Detection	NYSDEC TAGM 4046 ⁽²⁾	Number of Exceedances	Number of Detects	Number of Analyses ⁽³⁾	Value (Q)	
Sodium	MG/KG	4060	99%	172	86	177	178	191 J	298 J
Thallium	MG/KG	1.8	29%	0.7	24	51	178	0.915 J	0.59 J
Vanadium	MG/KG	28.5	100%	150	0	178	178	18.8	19.3
Zinc	MG/KG	341	100%	110	19	178	178	141 J	69.15 J

Note(s):

- (1) - Historical sample depths are presented (I.e. prior to 2002 TCRA)
- (2) - NYSDEC Technical and Administrative Guidance Memorandum (TAGM) HWR-94-4046, Revised January 24, 1994
- (3) - Sample/Duplicate pair are presented as individual samples in this table. Statistical information used Sample Duplicate pairs as a single entity and averaged result values were used in risk assessment analysis.

U = compound was not detected

J = the reported value is an estimated concentration

UJ = the compound was not detected; the associated reporting limit is approximate

R = the data was rejected in the data validating process

NJ = compound was "tentatively identified" and the associated numerical value is approximate

Table A-2B
SUBSURFACE SOIL SAMPLE RESULTS (2-15 ft.)
SEAD-59
SEAD-59 and SEAD-71 Phase II RI Report
Seneca Army Depot Activity

Facility	SEAD-59	SEAD-59	SEAD-59	SEAD-59
Location ID	MW59-4	SB59-1	SB59-11	SB59-13
Maxtrix	SOIL	SOIL	SOIL	SOIL
Sample ID	59055	SB59-1-06	59132	59060
Sample Depth to Top of Sample ⁽¹⁾	4	10	3	6
Sample Depth to Bottom of Sample ⁽¹⁾	6	12	5	6.9
Sample Date	10/20/1997	2/20/1994	10/24/1997	10/21/1997
QC Code	SA	SA	SA	SA
Study ID	RI PHASE 1 STEP 1	ESI	RI PHASE 1 STEP 1	RI PHASE 1 STEP 1

Parameter	Units	Maximum Value	Frequency of Detection	NYSDEC TAGM 4046 ⁽²⁾	Number of Exceedances	Number of Detects	Number of Analyses ⁽³⁾	Value (Q)	Value (Q)	Value (Q)	Value (Q)
Volatile Organics											
1,1,1-Trichloroethane	UG/KG	0	0%	800	0	0	21	12 U	12 U	11 U	55 U
1,1,2,2-Tetrachloroethane	UG/KG	0	0%	600	0	0	21	12 U	12 U	11 U	55 U
1,1,2-Trichloro-1,2,2-Trifluoroethane	UG/KG	0	0%		0	0	0				
1,1,2-Trichloroethane	UG/KG	0	0%		0	0	21	12 U	12 U	11 U	55 U
1,1-Dichloroethane	UG/KG	0	0%	200	0	0	21	12 U	12 U	11 U	55 U
1,1-Dichloroethene	UG/KG	0	0%	400	0	0	21	12 U	12 U	11 U	55 U
1,2,3-Trichloropropane	UG/KG	0	0%		0	0	0				
1,2,4-Trichlorobenzene	UG/KG	0	0%	3400	0	0	0				
1,2-Dibromo-3-chloropropane	UG/KG	0	0%		0	0	0				
1,2-Dibromoethane	UG/KG	0	0%		0	0	0				
1,2-Dichlorobenzene	UG/KG	0	0%	7900	0	0	0				
1,2-Dichloroethane	UG/KG	0	0%	100	0	0	21	12 U	12 U	11 U	55 U
1,2-Dichloroethene (total)	UG/KG	0	0%		0	0	21	12 U	12 U	11 U	55 U
1,2-Dichloropropane	UG/KG	0	0%		0	0	21	12 U	12 U	11 U	55 U
1,3-Dichlorobenzene	UG/KG	0	0%	1600	0	0	0				
1,3-Dichloropropane	UG/KG	0	0%		0	0	0				
1,4-Dichlorobenzene	UG/KG	0	0%	8500	0	0	0				
Acetone	UG/KG	30	5%	200	0	1	21	12 U	23 U	11 U	55 U
Benzene	UG/KG	8.5	5%	60	0	1	21	12 U	12 U	11 U	55 U
Bromodichloromethane	UG/KG	0	0%		0	0	21	12 U	12 U	11 U	55 U
Bromoform	UG/KG	0	0%		0	0	21	12 U	12 U	11 U	55 U
Carbon disulfide	UG/KG	0	0%	2700	0	0	21	12 U	12 U	11 U	55 U
Carbon tetrachloride	UG/KG	0	0%	600	0	0	21	12 U	12 U	11 U	55 U
Chlorobenzene	UG/KG	0	0%	1700	0	0	21	12 U	12 U	11 U	55 U
Chlorodibromomethane	UG/KG	0	0%		0	0	21	12 U	12 U	11 U	55 U
Chloroethane	UG/KG	0	0%	1900	0	0	21	12 U	12 U	11 U	55 U
Chloroform	UG/KG	0	0%	300	0	0	21	12 U	12 U	11 U	55 U
Cis-1,2-Dichloroethene	UG/KG	0	0%		0	0	0				
Cis-1,3-Dichloropropene	UG/KG	0	0%		0	0	21	12 U	12 U	11 U	55 U
Cyclohexane	UG/KG	0	0%		0	0	0				
Dichlorodifluoromethane	UG/KG	0	0%		0	0	0				
Ethyl benzene	UG/KG	110	10%	5500	0	2	21	12 U	12 U	11 U	55 U
Isopropylbenzene	UG/KG	0	10%		0	0	0				
Meta/Para Xylene	UG/KG	0	10%		0	0	0				
Methyl Acetate	UG/KG	0	10%		0	0	0				
Methyl Tertbutyl Ether	UG/KG	0	10%		0	0	0				
Methyl bromide	UG/KG	0	0%		0	0	21	12 U	12 U	11 U	55 U
Methyl butyl ketone	UG/KG	0	0%		0	0	21	12 U	12 U	11 U	55 U
Methyl chloride	UG/KG	3	5%		0	1	21	12 U	12 U	11 U	55 U
Methyl cyclohexane	UG/KG	0	5%		0	0	0				
Methyl ethyl ketone	UG/KG	36	14%	300	0	3	21	12 U	12 U	11 U	55 U
Methyl isobutyl ketone	UG/KG	0	0%	1000	0	0	21	12 U	12 U	11 U	55 U

Table A-2B
SUBSURFACE SOIL SAMPLE RESULTS (2-15 ft.)
SEAD-59
SEAD-59 and SEAD-71 Phase II RI Report
Seneca Army Depot Activity

Facility	SEAD-59	SEAD-59	SEAD-59	SEAD-59
Location ID	MW59-4	SB59-1	SB59-11	SB59-13
Maxtix	SOIL	SOIL	SOIL	SOIL
Sample ID	59055	SB59-1-06	59132	59060
Sample Depth to Top of Sample ⁽¹⁾	4	10	3	6
Sample Depth to Bottom of Sample ⁽¹⁾	6	12	5	6.9
Sample Date	10/20/1997	2/20/1994	10/24/1997	10/21/1997
QC Code	SA	SA	SA	SA
Study ID	RI PHASE 1 STEP 1	ESI	RI PHASE 1 STEP 1	RI PHASE 1 STEP 1

Parameter	Units	Maximum Value	Frequency of Detection	NYSDEC TAGM 4046 ⁽²⁾	Number of Exceedances	Number of Detects	Number of Analyses ⁽³⁾	Value (Q)	Value (Q)	Value (Q)	Value (Q)
Methylene chloride	UG/KG	1	5%	100	0	1	21	12 U	12 U	11 U	55 U
Ortho Xylene	UG/KG	0	5%		0	0	0				
Styrene	UG/KG	0	0%		0	0	21	12 U	12 U	11 U	55 U
Tetrachloroethene	UG/KG	0	0%	1400	0	0	21	12 U	12 U	11 U	55 U
Toluene	UG/KG	13.5	14%	1500	0	3	21	12 U	12 U	11 U	55 U
Total BTEX	MG/KG	9.5	93%		0	14	15	4			6
Total Xylenes	UG/KG	75.5	5%	1200	0	1	21	12 U	12 U	11 U	55 U
Trans-1,2-Dichloroethene	UG/KG	0	5%	300	0	0	0				
Trans-1,3-Dichloropropene	UG/KG	0	0%		0	0	21	12 U	12 U	11 U	55 U
Trichloroethene	UG/KG	0	0%	700	0	0	21	12 U	12 U	11 U	55 U
Trichlorofluoromethane	UG/KG	0	0%		0	0	0				
Vinyl chloride	UG/KG	0	0%	200	0	0	21	12 U	12 U	11 U	55 U
Semivolatile Organics											
1,1'-Biphenyl	UG/KG	0	0%		0	0	0				
1,2,4-Trichlorobenzene	UG/KG	0	0%	3400	0	0	21	78 U	530 U	70 U	140 U
1,2-Dichlorobenzene	UG/KG	0	0%	7900	0	0	21	78 U	530 U	70 U	140 U
1,3-Dichlorobenzene	UG/KG	0	0%	1600	0	0	21	78 U	530 U	70 U	140 U
1,4-Dichlorobenzene	UG/KG	0	0%	8500	0	0	21	78 U	530 U	70 U	140 U
2,2'-oxybis(1-Chloropropane)	UG/KG	0	0%		0	0	5		530 U		
2,4,5-Trichlorophenol	UG/KG	0	0%	100	0	0	21	190 U	1300 U	170 U	350 U
2,4,6-Trichlorophenol	UG/KG	0	0%		0	0	21	78 U	530 U	70 UJ	140 U
2,4-Dichlorophenol	UG/KG	0	0%	400	0	0	21	78 U	530 U	70 U	140 U
2,4-Dimethylphenol	UG/KG	0	0%		0	0	21	78 U	530 U	70 U	140 U
2,4-Dinitrophenol	UG/KG	0	0%	200	0	0	21	190 U	1300 U	170 UJ	350 U
2,4-Dinitrotoluene	UG/KG	0	0%		0	0	21	78 U	530 U	70 U	140 U
2,6-Dinitrotoluene	UG/KG	0	0%	1000	0	0	21	78 U	530 U	70 U	140 U
2-Chloronaphthalene	UG/KG	0	0%		0	0	21	78 U	530 U	70 U	140 U
2-Chlorophenol	UG/KG	0	0%	800	0	0	21	78 U	530 U	70 U	140 U
2-Methylnaphthalene	UG/KG	10000	57%	36400	0	12	21	78 U	78 J	70 U	93 J
2-Methylphenol	UG/KG	0	0%	100	0	0	21	78 U	530 U	70 U	140 U
2-Nitroaniline	UG/KG	0	0%	430	0	0	21	190 U	1300 U	170 U	350 U
2-Nitrophenol	UG/KG	0	0%	330	0	0	21	78 U	530 U	70 U	140 U
3,3'-Dichlorobenzidine	UG/KG	0	0%		0	0	21	78 U	530 U	70 U	140 U
3-Nitroaniline	UG/KG	0	0%	500	0	0	21	190 U	1300 U	170 UJ	350 U
4,6-Dinitro-2-methylphenol	UG/KG	0	0%		0	0	21	190 U	1300 U	170 U	350 U
4-Bromophenyl phenyl ether	UG/KG	0	0%		0	0	21	78 U	530 U	70 U	140 U
4-Chloro-3-methylphenol	UG/KG	0	0%	240	0	0	21	78 U	530 U	70 U	140 U
4-Chloroaniline	UG/KG	0	0%	220	0	0	21	78 U	530 U	70 UJ	140 U
4-Chlorophenyl phenyl ether	UG/KG	0	0%		0	0	21	78 U	530 U	70 U	140 U
4-Methylphenol	UG/KG	83	10%	900	0	2	21	78 U	530 U	70 U	140 U
4-Nitroaniline	UG/KG	0	0%		0	0	21	190 U	1300 U	170 U	350 U
4-Nitrophenol	UG/KG	0	0%	100	0	0	21	190 U	1300 U	170 U	350 U
Acenaphthene	UG/KG	1600	57%	50000	0	12	21	78 U	190 J	70 U	110 J

Table A-2B
SUBSURFACE SOIL SAMPLE RESULTS (2-15 ft.)
SEAD-59
SEAD-59 and SEAD-71 Phase II RI Report
Seneca Army Depot Activity

Facility	SEAD-59	SEAD-59	SEAD-59	SEAD-59
Location ID	MW59-4	SB59-1	SB59-11	SB59-13
Maxtix	SOIL	SOIL	SOIL	SOIL
Sample ID	59055	SB59-1-06	59132	59060
Sample Depth to Top of Sample ⁽¹⁾	4	10	3	6
Sample Depth to Bottom of Sample ⁽¹⁾	6	12	5	6.9
Sample Date	10/20/1997	2/20/1994	10/24/1997	10/21/1997
QC Code	SA	SA	SA	SA
Study ID	RI PHASE 1 STEP 1	ESI	RI PHASE 1 STEP 1	RI PHASE 1 STEP 1

Parameter	Units	Maximum	Frequency of	NYSDEC	Number of	Number of	Number of	Value (Q)	Value (Q)	Value (Q)	Value (Q)
		Value	Detection	TAGM 4046 ⁽²⁾	Exceedances	Detects	Analyses ⁽³⁾				
Acenaphthylene	UG/KG	460	48%	41000	0	10	21	78 U	97 J	70 U	140 U
Acetophenone	UG/KG	0	48%		0	0	0				
Aniline	UG/KG	0	48%		0	0	0				
Anthracene	UG/KG	2100	48%	50000	0	10	21	78 U	600	70 U	140 U
Atrazine	UG/KG	0	48%		0	0	0				
Benzaldehyde	UG/KG	0	48%		0	0	0				
Benzo(a)anthracene	UG/KG	4200	67%	224	7	14	21	78 U	1200	3.8 J	140 U
Benzo(a)pyrene	UG/KG	4600	67%	61	9	14	21	78 U	1100	3.6 J	140 U
Benzo(b)fluoranthene	UG/KG	4400	76%	1100	3	16	21	78 U	860	3.8 J	140 U
Benzo(ghi)perylene	UG/KG	2400	62%	50000	0	13	21	78 U	560	70 U	140 U
Benzo(k)fluoranthene	UG/KG	4900	62%	1100	3	13	21	78 U	810	3.7 J	140 U
Benzoic Acid	UG/KG	0	62%	2700	0	0	0				
Bis(2-Chloroethoxy)methane	UG/KG	0	0%		0	0	21	78 U	530 U	70 U	140 U
Bis(2-Chloroethyl)ether	UG/KG	0	0%		0	0	21	78 U	530 U	70 U	140 U
Bis(2-Chloroisopropyl)ether	UG/KG	0	0%		0	0	16	78 U		70 U	140 U
Bis(2-Ethylhexyl)phthalate	UG/KG	260	71%	50000	0	15	21	13 J	260 J	16 J	38 J
Butylbenzylphthalate	UG/KG	1000	10%	50000	0	2	21	78 U	530 U	70 U	140 U
Caprolactam	UG/KG	0	10%		0	0	0				
Carbazole	UG/KG	1500	52%		0	11	21	78 U	260 J	70 U	140 U
Chrysene	UG/KG	4400	71%	400	5	15	21	78 U	1200	4.8 J	140 U
Di-n-butylphthalate	UG/KG	29	43%	8100	0	9	21	78 U	29 J	9.9 J	140 U
Di-n-octylphthalate	UG/KG	11	10%	50000	0	2	21	78 U	530 U	70 U	140 U
Dibenz(a,h)anthracene	UG/KG	890	38%	14	7	8	21	78 U	530 U	70 U	140 U
Dibenzofuran	UG/KG	1400	48%	6200	0	10	21	78 U	130 J	70 U	110 J
Diethyl phthalate	UG/KG	12	38%	7100	0	8	21	5.5 J	530 U	5.4 J	140 U
Dimethylphthalate	UG/KG	0	0%	2000	0	0	21	78 U	530 U	70 U	140 U
Fluoranthene	UG/KG	10000	71%	50000	0	15	21	78 U	2600	9.4 J	140 U
Fluorene	UG/KG	3000	52%	50000	0	11	21	78 U	280 J	70 U	260
Hexachlorobenzene	UG/KG	0	0%	410	0	0	21	78 U	530 U	70 U	140 U
Hexachlorobutadiene	UG/KG	0	0%		0	0	21	78 U	530 U	70 U	140 U
Hexachlorocyclopentadiene	UG/KG	0	0%		0	0	21	78 U	530 U	70 U	140 U
Hexachloroethane	UG/KG	0	0%		0	0	21	78 U	530 U	70 U	140 U
Indeno(1,2,3-cd)pyrene	UG/KG	2300	62%	3200	0	13	21	78 U	590	70 U	140 U
Isophorone	UG/KG	0	0%	4400	0	0	21	78 U	530 U	70 U	140 U
N-Nitrosodiphenylamine	UG/KG	0	0%		0	0	21	78 U	530 U	70 U	140 U
N-Nitrosodipropylamine	UG/KG	0	0%		0	0	21	78 U	530 U	70 U	140 U
Naphthalene	UG/KG	750	48%	13000	0	10	21	78 U	110 J	70 U	69 J
Nitrobenzene	UG/KG	0	0%	200	0	0	21	78 U	530 U	70 U	140 U
Pentachlorophenol	UG/KG	0	0%	1000	0	0	21	190 U	1300 U	170 UJ	350 U
Phenanthrene	UG/KG	8300	81%	50000	0	17	21	78 U	1800	11 J	280
Phenol	UG/KG	17	5%	30	0	1	21	78 U	530 U	70 U	140 U
Pyrene	UG/KG	12000	80%	50000	0	16	20	78 U	2200	7.2 J	25 J
Pyridine	UG/KG	0	80%		0	0	0				

Table A-2B
SUBSURFACE SOIL SAMPLE RESULTS (2-15 ft.)
SEAD-59
SEAD-59 and SEAD-71 Phase II RI Report
Seneca Army Depot Activity

Facility	SEAD-59	SEAD-59	SEAD-59	SEAD-59
Location ID	MW59-4	SB59-1	SB59-11	SB59-13
Maxtrix	SOIL	SOIL	SOIL	SOIL
Sample ID	59055	SB59-1-06	59132	59060
Sample Depth to Top of Sample ⁽¹⁾	4	10	3	6
Sample Depth to Bottom of Sample ⁽¹⁾	6	12	5	6.9
Sample Date	10/20/1997	2/20/1994	10/24/1997	10/21/1997
QC Code	SA	SA	SA	SA
Study ID	RI PHASE 1 STEP 1	ESI	RI PHASE 1 STEP 1	RI PHASE 1 STEP 1

Parameter	Units	Maximum Value	Frequency of Detection	NYSDEC TAGM 4046 ⁽²⁾	Number of Exceedances	Number of Detects	Number of Analyses ⁽³⁾	Value (Q)	Value (Q)	Value (Q)	Value (Q)
Total Unknown PAHs as SV	MG/KG	25	36%		0	5	14	0.6 U			25 J
Pesticides/PCBs											
4,4'-DDD	UG/KG	70	29%	2900	0	6	21	3.9 U	11	3.5 U	3.6 U
4,4'-DDE	UG/KG	48	48%	2100	0	10	21	3.6 J	7.3 J	3.5 U	3.6 U
4,4'-DDT	UG/KG	59	33%	2100	0	7	21	4.4	21	3.5 U	3.6 U
Aldrin	UG/KG	0	0%	41	0	0	21	2 U	2.1 U	1.8 U	1.8 U
Alpha-BHC	UG/KG	9.9	10%	110	0	2	21	9.9 J	2.1 U	1.8 U	6.6 UJ
Alpha-Chlordane	UG/KG	17	10%		0	2	21	2 U	2.1 U	1.8 U	1.8 U
Beta-BHC	UG/KG	3.6	24%	200	0	5	21	3.4 J	2.1 U	1.8 U	2.6 J
Delta-BHC	UG/KG	1.4	19%	300	0	4	21	1.2 J	2.1 U	1.8 U	0.95 J
Dieldrin	UG/KG	1.8	5%	44	0	1	21	3.9 U	4 U	3.5 U	3.6 U
Endosulfan I	UG/KG	4.1	5%	900	0	1	21	2 U	2.1 U	1.8 U	1.8 U
Endosulfan II	UG/KG	7.1	5%	900	0	1	21	3.9 U	4 U	3.5 U	3.6 U
Endosulfan sulfate	UG/KG	4.3	5%	1000	0	1	21	3.9 U	4 U	3.5 U	3.6 U
Endrin	UG/KG	7.7	5%	100	0	1	21	3.9 U	4 U	3.5 U	3.6 U
Endrin aldehyde	UG/KG	6.3	14%		0	3	21	3.9 U	3.9 J	3.5 U	3.6 U
Endrin ketone	UG/KG	4.4	5%		0	1	21	3.9 U	4 U	3.5 U	3.6 U
Gamma-BHC/Lindane	UG/KG	0	0%	60	0	0	21	2.6 U	2.1 U	1.8 U	2 UJ
Gamma-Chlordane	UG/KG	18	10%	540	0	2	21	2 U	2.1 U	1.8 U	1.8 U
Heptachlor	UG/KG	0	0%	100	0	0	21	2 U	2.1 U	1.8 U	1.8 U
Heptachlor epoxide	UG/KG	5.7	14%	20	0	3	21	2 U	2.1 U	1.8 U	1.8 U
Methoxychlor	UG/KG	0	0%		0	0	21	20 U	21 U	18 U	18 U
Toxaphene	UG/KG	0	0%		0	0	21	200 U	210 U	180 U	180 U
Aroclor-1016	UG/KG	0	0%		0	0	21	39 U	40 U	35 U	36 U
Aroclor-1221	UG/KG	0	0%		0	0	21	80 U	81 U	71 U	73 U
Aroclor-1232	UG/KG	0	0%		0	0	21	39 U	40 U	35 U	36 U
Aroclor-1242	UG/KG	0	0%		0	0	20	39 U	40 U	35 U	36 U
Aroclor-1248	UG/KG	0	0%		0	0	21	39 U	40 U	35 U	36 U
Aroclor-1254	UG/KG	0	0%	10000	0	0	21	39 U	40 U	35 U	36 U
Aroclor-1260	UG/KG	0	0%	10000	0	0	21	39 U	40 U	35 U	36 U
Metals											
Aluminum	MG/KG	15200	100%	19300	0	21	21	10700	11800 J	7740	11100
Antimony	MG/KG	0.47	14%	5.9	0	3	21	0.58 UJ	0.24 J	0.61 UJ	0.6 UJ
Arsenic	MG/KG	6	100%	8.2	0	21	21	4.8	3.8 J	4.1	5.7
Barium	MG/KG	192	100%	300	0	21	21	49.7	75.7 J	43.7	52
Beryllium	MG/KG	0.52	100%	1.1	0	21	21	0.39	0.48 J	0.24	0.27
Cadmium	MG/KG	0.61	24%	2.3	0	5	21	0.08 U	0.1 J	0.08 U	0.08 U
Calcium	MG/KG	123000	100%	121000	1	21	21	2060	37400 J	72200	33900
Chromium	MG/KG	20.7	100%	29.6	0	21	21	18.5	18.1 J	13	18.6
Cobalt	MG/KG	14.2	100%	30	0	21	21	11.4	8.6 J	8.1	14.2
Copper	MG/KG	36.1	100%	33	1	21	21	12.5	23.5 J	19.7	21
Cyanide	MG/KG	0	0%	0.35	0	0	21	0.62 UJ	0.59 U	0.56 UJ	0.58 UJ
Iron	MG/KG	28900	100%	36500	0	21	21	25300	20500 J	18400	28900

Table A-2B
SUBSURFACE SOIL SAMPLE RESULTS (2-15 ft.)
SEAD-59
SEAD-59 and SEAD-71 Phase II RI Report
Seneca Army Depot Activity

Facility	SEAD-59	SEAD-59	SEAD-59	SEAD-59
Location ID	MW59-4	SB59-1	SB59-11	SB59-13
Maxtrix	SOIL	SOIL	SOIL	SOIL
Sample ID	59055	SB59-1-06	59132	59060
Sample Depth to Top of Sample ⁽¹⁾	4	10	3	6
Sample Depth to Bottom of Sample ⁽¹⁾	6	12	5	6.9
Sample Date	10/20/1997	2/20/1994	10/24/1997	10/21/1997
QC Code	SA	SA	SA	SA
Study ID	RI PHASE 1 STEP 1	ESI	RI PHASE 1 STEP 1	RI PHASE 1 STEP 1

Parameter	Units	Maximum	Frequency of	NYSDEC	Number of	Number of	Number of	Value (Q)	Value (Q)	Value (Q)	Value (Q)
		Value	Detection	TAGM 4046 ⁽²⁾	Exceedances	Detects	Analyses ⁽³⁾				
Lead	MG/KG	65.5	100%	24.8	7	21	21	15.7	10.5 J	9.6	8.7
Magnesium	MG/KG	34400	100%	21500	1	21	21	4390	14500 J	13600	7990
Manganese	MG/KG	1150	100%	1060	1	21	21	376	329 J	356	576
Mercury	MG/KG	0.32	50%	0.1	4	10	20	0.04 U	0.03 J	0.04 U	0.05 U
Nickel	MG/KG	35.5	100%	49	0	21	21	29.7	27.9 J	23.2	35.5
Potassium	MG/KG	2520	100%	2380	1	21	21	1110	2520 J	1000	1060
Selenium	MG/KG	1.5	24%	2	0	5	21	0.8 U	0.42 J	0.84 U	0.83 U
Silver	MG/KG	0.25	5%	0.75	0	1	21	0.22 U	0.12 U	0.23 U	0.23 U
Sodium	MG/KG	1150	81%	172	6	17	21	98	164 J	127	112
Thallium	MG/KG	0	0%	0.7	0	0	21	0.82 UJ	0.22 U	0.86 UJ	0.85 UJ
Vanadium	MG/KG	26.3	100%	150	0	21	21	14.8	22 J	12.6	15
Zinc	MG/KG	133	100%	110	2	21	21	133	69.7 J	80.5	60.5

Note(s):

- (1) - Historical sample depths are presented (I.e. prior to 2002 TCRA)
- (2) - NYSDEC Technical and Administrative Guidance Memorandum (TAGM) HWR-94-4046, Revised January 24, 1994
- (3) - Sample/Duplicate pair are presented as individual samples in this table. Statistical information used Sample Duplicate pairs as a single entity and averaged result values were used in risk assessment analysis.

U = compound was not detected

J = the reported value is an estimated concentration

UJ = the compound was not detected; the associated reporting limit is approximate

R = the data was rejected in the data validating process

NJ = compound was "tentatively identified" and the associated numerical value is approximate

Table A-2B
SUBSURFACE SOIL SAMPLE RESULTS (2-15 ft.)
SEAD-59
SEAD-59 and SEAD-71 Phase II RI Report
Seneca Army Depot Activity

Facility	SEAD-59	SEAD-59	SEAD-59	SEAD-59
Location ID	SB59-15	SB59-17	SB59-18	SB59-2
Maxtrix	SOIL	SOIL	SOIL	SOIL
Sample ID	59061	59068/59131	59127	SB59-2-04
Sample Depth to Top of Sample ⁽¹⁾	4	8	10	6
Sample Depth to Bottom of Sample ⁽¹⁾	5.3	9.2	11	7
Sample Date	10/21/1997	35726	10/24/1997	5/26/1994
QC Code	SA	SA/DU	SA	SA
Study ID	RI PHASE 1 STEP 1	RI PHASE 1 STEP 1	RI PHASE 1 STEP 1	ESI

Parameter	Units	Maximum	Frequency of	NYSDEC	Number of	Number of	Number of	Value (Q)	Value (Q)	Value (Q)	Value (Q)
		Value	Detection	TAGM 4046 ⁽²⁾	Exceedances	Detects	Analyses ⁽³⁾				
Volatile Organics											
1,1,1-Trichloroethane	UG/KG	0	0%	800	0	0	21	11 U	35.5 U	11 U	12 U
1,1,2,2-Tetrachloroethane	UG/KG	0	0%	600	0	0	21	11 U	35.5 U	11 U	12 U
1,1,2-Trichloro-1,2,2-Trifluoroethane	UG/KG	0	0%		0	0	0				
1,1,2-Trichloroethane	UG/KG	0	0%		0	0	21	11 U	35.5 U	11 U	12 U
1,1-Dichloroethane	UG/KG	0	0%	200	0	0	21	11 U	35.5 U	11 U	12 U
1,1-Dichloroethene	UG/KG	0	0%	400	0	0	21	11 U	35.5 U	11 U	12 U
1,2,3-Trichloropropane	UG/KG	0	0%		0	0	0				
1,2,4-Trichlorobenzene	UG/KG	0	0%	3400	0	0	0				
1,2-Dibromo-3-chloropropane	UG/KG	0	0%		0	0	0				
1,2-Dibromoethane	UG/KG	0	0%		0	0	0				
1,2-Dichlorobenzene	UG/KG	0	0%	7900	0	0	0				
1,2-Dichloroethane	UG/KG	0	0%	100	0	0	21	11 U	35.5 U	11 U	12 U
1,2-Dichloroethene (total)	UG/KG	0	0%		0	0	21	11 U	35.5 U	11 U	12 U
1,2-Dichloropropane	UG/KG	0	0%		0	0	21	11 U	35.5 U	11 U	12 U
1,3-Dichlorobenzene	UG/KG	0	0%	1600	0	0	0				
1,3-Dichloropropane	UG/KG	0	0%		0	0	0				
1,4-Dichlorobenzene	UG/KG	0	0%	8500	0	0	0				
Acetone	UG/KG	30	5%	200	0	1	21	11 U	35.5 U	11 U	23 U
Benzene	UG/KG	8.5	5%	60	0	1	21	11 U	8.5 J	11 U	12 U
Bromodichloromethane	UG/KG	0	0%		0	0	21	11 U	35.5 U	11 U	12 U
Bromoform	UG/KG	0	0%		0	0	21	11 U	35.5 U	11 U	12 U
Carbon disulfide	UG/KG	0	0%	2700	0	0	21	11 U	35.5 U	11 U	12 U
Carbon tetrachloride	UG/KG	0	0%	600	0	0	21	11 U	35.5 U	11 U	12 U
Chlorobenzene	UG/KG	0	0%	1700	0	0	21	11 U	35.5 U	11 U	12 U
Chlorodibromomethane	UG/KG	0	0%		0	0	21	11 U	35.5 U	11 U	12 U
Chloroethane	UG/KG	0	0%	1900	0	0	21	11 U	35.5 U	11 U	12 U
Chloroform	UG/KG	0	0%	300	0	0	21	11 U	35.5 U	11 U	12 U
Cis-1,2-Dichloroethene	UG/KG	0	0%		0	0	0				
Cis-1,3-Dichloropropene	UG/KG	0	0%		0	0	21	11 U	35.5 U	11 U	12 U
Cyclohexane	UG/KG	0	0%		0	0	0				
Dichlorodifluoromethane	UG/KG	0	0%		0	0	0				
Ethyl benzene	UG/KG	110	10%	5500	0	2	21	11 U	12.5 J	11 U	12 U
Isopropylbenzene	UG/KG	0	10%		0	0	0				
Meta/Para Xylene	UG/KG	0	10%		0	0	0				
Methyl Acetate	UG/KG	0	10%		0	0	0				
Methyl Tertbutyl Ether	UG/KG	0	10%		0	0	0				
Methyl bromide	UG/KG	0	0%		0	0	21	11 U	35.5 U	11 U	12 U
Methyl butyl ketone	UG/KG	0	0%		0	0	21	11 U	35.5 U	11 U	12 U
Methyl chloride	UG/KG	3	5%		0	1	21	11 U	35.5 U	11 U	12 U
Methyl cyclohexane	UG/KG	0	5%		0	0	0				
Methyl ethyl ketone	UG/KG	36	14%	300	0	3	21	11 U	35.5 U	11 U	12 U
Methyl isobutyl ketone	UG/KG	0	0%	1000	0	0	21	11 U	35.5 U	11 U	12 U

Table A-2B
SUBSURFACE SOIL SAMPLE RESULTS (2-15 ft.)
SEAD-59
SEAD-59 and SEAD-71 Phase II RI Report
Seneca Army Depot Activity

Facility	SEAD-59	SEAD-59	SEAD-59	SEAD-59
Location ID	SB59-15	SB59-17	SB59-18	SB59-2
Maxtrix	SOIL	SOIL	SOIL	SOIL
Sample ID	59061	59068/59131	59127	SB59-2-04
Sample Depth to Top of Sample ⁽¹⁾	4	8	10	6
Sample Depth to Bottom of Sample ⁽¹⁾	5.3	9.2	11	7
Sample Date	10/21/1997	35726	10/24/1997	5/26/1994
QC Code	SA	SA/DU	SA	SA
Study ID	RI PHASE 1 STEP 1	RI PHASE 1 STEP 1	RI PHASE 1 STEP 1	ESI

Parameter	Units	Maximum Value	Frequency of Detection	NYSDEC TAGM 4046 ⁽²⁾	Number of Exceedances	Number of Detects	Number of Analyses ⁽³⁾	Value (Q)	Value (Q)	Value (Q)	Value (Q)
Methylene chloride	UG/KG	1	5%	100	0	1	21	11 U	35.5 U	11 U	12 U
Ortho Xylene	UG/KG	0	5%		0	0	0				
Styrene	UG/KG	0	0%		0	0	21	11 U	35.5 U	11 U	12 U
Tetrachloroethene	UG/KG	0	0%	1400	0	0	21	11 U	35.5 U	11 U	12 U
Toluene	UG/KG	13.5	14%	1500	0	3	21	11 U	13.5 J	11 U	12 U
Total BTEX	MG/KG	9.5	93%		0	14	15	4.8	5.2	4.8	
Total Xylenes	UG/KG	75.5	5%	1200	0	1	21	11 U	75.5 J	11 U	12 U
Trans-1,2-Dichloroethene	UG/KG	0	5%	300	0	0	0				
Trans-1,3-Dichloropropene	UG/KG	0	0%		0	0	21	11 U	35.5 U	11 U	12 U
Trichloroethene	UG/KG	0	0%	700	0	0	21	11 U	35.5 U	11 U	12 U
Trichlorofluoromethane	UG/KG	0	0%		0	0	0				
Vinyl chloride	UG/KG	0	0%	200	0	0	21	11 U	35.5 U	11 U	12 U
Semivolatiles Organics											
1,1'-Biphenyl	UG/KG	0	0%		0	0	0				
1,2,4-Trichlorobenzene	UG/KG	0	0%	3400	0	0	21	77 U	75 U	380 U	390 U
1,2-Dichlorobenzene	UG/KG	0	0%	7900	0	0	21	77 U	75 U	380 U	390 U
1,3-Dichlorobenzene	UG/KG	0	0%	1600	0	0	21	77 U	75 U	380 U	390 U
1,4-Dichlorobenzene	UG/KG	0	0%	8500	0	0	21	77 U	75 U	380 U	390 U
2,2'-oxybis(1-Chloropropane)	UG/KG	0	0%		0	0	5				390 U
2,4,5-Trichlorophenol	UG/KG	0	0%	100	0	0	21	190 U	180 U	910 U	940 U
2,4,6-Trichlorophenol	UG/KG	0	0%		0	0	21	77 U	75 U	380 U	390 U
2,4-Dichlorophenol	UG/KG	0	0%	400	0	0	21	77 U	75 U	380 U	390 U
2,4-Dimethylphenol	UG/KG	0	0%		0	0	21	77 U	75 U	380 U	390 U
2,4-Dinitrophenol	UG/KG	0	0%	200	0	0	21	190 U	180 U	910 UJ	940 U
2,4-Dinitrotoluene	UG/KG	0	0%		0	0	21	77 U	75 U	380 U	390 U
2,6-Dinitrotoluene	UG/KG	0	0%		0	0	21	77 U	75 U	380 U	390 U
2-Chloronaphthalene	UG/KG	0	0%		0	0	21	77 U	75 U	380 U	390 U
2-Chlorophenol	UG/KG	0	0%	800	0	0	21	77 U	75 U	380 U	390 U
2-Methylnaphthalene	UG/KG	10000	57%	36400	0	12	21	77 U	20 J	250 J	150 J
2-Methylphenol	UG/KG	0	0%	100	0	0	21	77 U	75 U	380 U	390 U
2-Nitroaniline	UG/KG	0	0%	430	0	0	21	190 U	180 U	910 U	940 U
2-Nitrophenol	UG/KG	0	0%	330	0	0	21	77 U	75 U	380 U	390 U
3,3'-Dichlorobenzidine	UG/KG	0	0%		0	0	21	77 U	75 U	380 U	390 U
3-Nitroaniline	UG/KG	0	0%	500	0	0	21	190 U	180 U	910 U	940 U
4,6-Dinitro-2-methylphenol	UG/KG	0	0%		0	0	21	190 U	180 U	910 U	940 U
4-Bromophenyl phenyl ether	UG/KG	0	0%		0	0	21	77 U	75 U	380 U	390 U
4-Chloro-3-methylphenol	UG/KG	0	0%	240	0	0	21	77 U	75 U	380 U	390 U
4-Chloroaniline	UG/KG	0	0%	220	0	0	21	77 U	75 U	380 UJ	390 U
4-Chlorophenyl phenyl ether	UG/KG	0	0%		0	0	21	77 U	75 U	380 U	390 U
4-Methylphenol	UG/KG	83	10%	900	0	2	21	77 U	75 U	380 UJ	28 J
4-Nitroaniline	UG/KG	0	0%		0	0	21	190 U	180 U	910 U	940 U
4-Nitrophenol	UG/KG	0	0%	100	0	0	21	190 U	180 U	910 U	940 U
Acenaphthene	UG/KG	1600	57%	50000	0	12	21	77 U	13.5 J	180 J	100 J

Table A-2B
SUBSURFACE SOIL SAMPLE RESULTS (2-15 ft.)
SEAD-59
SEAD-59 and SEAD-71 Phase II RI Report
Seneca Army Depot Activity

Facility	SEAD-59	SEAD-59	SEAD-59	SEAD-59
Location ID	SB59-15	SB59-17	SB59-18	SB59-2
Maxtrix	SOIL	SOIL	SOIL	SOIL
Sample ID	59061	59068/59131	59127	SB59-2-04
Sample Depth to Top of Sample ⁽¹⁾	4	8	10	6
Sample Depth to Bottom of Sample ⁽¹⁾	5.3	9.2	11	7
Sample Date	10/21/1997	35726	10/24/1997	5/26/1994
QC Code	SA	SA/DU	SA	SA
Study ID	RI PHASE 1 STEP 1	RI PHASE 1 STEP 1	RI PHASE 1 STEP 1	ESI

Parameter	Units	Maximum	Frequency of	NYSDEC	Number of	Number of	Number of	Value (Q)	Value (Q)	Value (Q)	Value (Q)
		Value	Detection	TAGM 4046 ⁽²⁾	Exceedances	Detects	Analyses ⁽³⁾				
Acenaphthylene	UG/KG	460	48%	41000	0	10	21	77 U	39.8 J	41 J	23 J
Acetophenone	UG/KG	0	48%		0	0	0				
Aniline	UG/KG	0	48%		0	0	0				
Anthracene	UG/KG	2100	48%	50000	0	10	21	77 U	25.5 J	380	160 J
Atrazine	UG/KG	0	48%		0	0	0				
Benzaldehyde	UG/KG	0	48%		0	0	0				
Benzo(a)anthracene	UG/KG	4200	67%	224	7	14	21	77 U	47 J	620	260 J
Benzo(a)pyrene	UG/KG	4600	67%	61	9	14	21	77 U	36 J	570	250 J
Benzo(b)fluoranthene	UG/KG	4400	76%	1100	3	16	21	7.6 J	38 J	920	290 J
Benzo(ghi)perylene	UG/KG	2400	62%	50000	0	13	21	77 U	22.5 J	320 J	130 J
Benzo(k)fluoranthene	UG/KG	4900	62%	1100	3	13	21	77 U	43 J	380 U	270 J
Benzoic Acid	UG/KG	0	62%	2700	0	0	0				
Bis(2-Chloroethoxy)methane	UG/KG	0	0%		0	0	21	77 U	75 U	380 U	390 U
Bis(2-Chloroethyl)ether	UG/KG	0	0%		0	0	21	77 U	75 U	380 U	390 U
Bis(2-Chloroisopropyl)ether	UG/KG	0	0%		0	0	16	77 U	75 U	380 U	
Bis(2-Ethylhexyl)phthalate	UG/KG	260	71%	50000	0	15	21	17 J	20.5 J	380 U	35 J
Butylbenzylphthalate	UG/KG	1000	10%	50000	0	2	21	77 U	75 U	380 U	390 U
Caprolactam	UG/KG	0	10%		0	0	0				
Carbazole	UG/KG	1500	52%		0	11	21	77 U	21.5 J	370 J	64 J
Chrysene	UG/KG	4400	71%	400	5	15	21	4.8 J	47 J	600	270 J
Di-n-butylphthalate	UG/KG	29	43%	8100	0	9	21	5.4 J	5.05 J	380 U	390 U
Di-n-octylphthalate	UG/KG	11	10%	50000	0	2	21	77 U	75 U	380 U	390 U
Dibenz(a,h)anthracene	UG/KG	890	38%	14	7	8	21	77 U	8.9 J	150 J	84 J
Dibenzofuran	UG/KG	1400	48%	6200	0	10	21	77 U	12.55 J	280 J	82 J
Diethyl phthalate	UG/KG	12	38%	7100	0	8	21	11 J	7.65 J	380 U	390 U
Dimethylphthalate	UG/KG	0	0%	2000	0	0	21	77 U	75 U	380 U	390 U
Fluoranthene	UG/KG	10000	71%	50000	0	15	21	4.8 J	112.5 J	1500	750
Fluorene	UG/KG	3000	52%	50000	0	11	21	77 U	24.5 J	530	160 J
Hexachlorobenzene	UG/KG	0	0%	410	0	0	21	77 U	75 U	380 U	390 U
Hexachlorobutadiene	UG/KG	0	0%		0	0	21	77 U	75 U	380 UJ	390 U
Hexachlorocyclopentadiene	UG/KG	0	0%		0	0	21	77 U	75 U	380 U	390 U
Hexachloroethane	UG/KG	0	0%		0	0	21	77 U	75 U	380 U	390 U
Indeno(1,2,3-cd)pyrene	UG/KG	2300	62%	3200	0	13	21	77 U	21.5 J	300 J	130 J
Isophorone	UG/KG	0	0%	4400	0	0	21	77 U	75 U	380 U	390 U
N-Nitrosodiphenylamine	UG/KG	0	0%		0	0	21	77 U	75 U	380 U	390 U
N-Nitrosodipropylamine	UG/KG	0	0%		0	0	21	77 U	75 U	380 U	390 U
Naphthalene	UG/KG	750	48%	13000	0	10	21	77 U	21.5 J	750	160 J
Nitrobenzene	UG/KG	0	0%	200	0	0	21	77 U	75 U	380 U	390 U
Pentachlorophenol	UG/KG	0	0%	1000	0	0	21	190 U	180 U	910 U	940 U
Phenanthrene	UG/KG	8300	81%	50000	0	17	21	4.6 J	121.5 J	1900	620
Phenol	UG/KG	17	5%	30	0	1	21	77 U	75 U	380 U	390 U
Pyrene	UG/KG	12000	80%	50000	0	16	20	5.1 J	111.5 J	1300	510
Pyridine	UG/KG	0	80%		0	0	0				

Table A-2B
SUBSURFACE SOIL SAMPLE RESULTS (2-15 ft.)
SEAD-59
SEAD-59 and SEAD-71 Phase II RI Report
Seneca Army Depot Activity

Facility	SEAD-59	SEAD-59	SEAD-59	SEAD-59
Location ID	SB59-15	SB59-17	SB59-18	SB59-2
Maxtrix	SOIL	SOIL	SOIL	SOIL
Sample ID	59061	59068/59131	59127	SB59-2-04
Sample Depth to Top of Sample ⁽¹⁾	4	8	10	6
Sample Depth to Bottom of Sample ⁽¹⁾	5.3	9.2	11	7
Sample Date	10/21/1997	35726	10/24/1997	5/26/1994
QC Code	SA	SA/DU	SA	SA
Study ID	RI PHASE 1 STEP 1	RI PHASE 1 STEP 1	RI PHASE 1 STEP 1	ESI

Parameter	Units	Maximum Value	Frequency of Detection	NYSDEC TAGM 4046 ⁽²⁾	Number of Exceedances	Number of Detects	Number of Analyses ⁽³⁾	Value (Q)	Value (Q)	Value (Q)	Value (Q)
Total Unknown PAHs as SV	MG/KG	25	36%		0	5	14	0.6 U	0.6 U	25 J	
Pesticides/PCBs											
4,4'-DDD	UG/KG	70	29%	2900	0	6	21	3.8 U	3.8 U	12 U	5.4 J
4,4'-DDE	UG/KG	48	48%	2100	0	10	21	1.8 J	3.8 U	8.2 U	8.2 J
4,4'-DDT	UG/KG	59	33%	2100	0	7	21	3.8 U	3.8 U	11 U	3.9 UJ
Aldrin	UG/KG	0	0%	41	0	0	21	2 U	1.9 U	1.9 U	2 UJ
Alpha-BHC	UG/KG	9.9	10%	110	0	2	21	6.3 UJ	1.9 U	1.9 U	2 UJ
Alpha-Chlordane	UG/KG	17	10%		0	2	21	2 U	1.9 U	1.9 U	2 UJ
Beta-BHC	UG/KG	3.6	24%	200	0	5	21	2.4 J	1.9 U	1.9 U	2 UJ
Delta-BHC	UG/KG	1.4	19%	300	0	4	21	2 U	1.9 U	1.9 U	2 UJ
Dieldrin	UG/KG	1.8	5%	44	0	1	21	3.8 U	3.8 U	3.8 U	3.9 UJ
Endosulfan I	UG/KG	4.1	5%	900	0	1	21	2 U	1.9 U	1.9 U	4.1 J
Endosulfan II	UG/KG	7.1	5%	900	0	1	21	3.8 U	3.8 U	3.8 U	3.9 UJ
Endosulfan sulfate	UG/KG	4.3	5%	1000	0	1	21	3.8 U	3.8 U	3.8 U	3.9 UJ
Endrin	UG/KG	7.7	5%	100	0	1	21	3.8 U	3.8 U	3.8 U	3.9 UJ
Endrin aldehyde	UG/KG	6.3	14%		0	3	21	3.8 U	3.8 U	3.8 U	3.9 UJ
Endrin ketone	UG/KG	4.4	5%		0	1	21	3.8 U	3.8 U	3.8 U	3.9 UJ
Gamma-BHC/Lindane	UG/KG	0	0%	60	0	0	21	1.9 UJ	1.9 U	1.9 U	2 UJ
Gamma-Chlordane	UG/KG	18	10%	540	0	2	21	2 U	1.9 U	1.9 U	2 UJ
Heptachlor	UG/KG	0	0%	100	0	0	21	2 U	1.9 U	1.9 U	2 UJ
Heptachlor epoxide	UG/KG	5.7	14%	20	0	3	21	2 U	1.9 U	1.9 U	2 UJ
Methoxychlor	UG/KG	0	0%		0	0	21	20 U	19 U	19 U	20 UJ
Toxaphene	UG/KG	0	0%		0	0	21	200 U	190 U	190 U	200 UJ
Aroclor-1016	UG/KG	0	0%		0	0	21	38 U	38 U	38 U	39 UJ
Aroclor-1221	UG/KG	0	0%		0	0	21	78 U	76 U	76 U	79 UJ
Aroclor-1232	UG/KG	0	0%		0	0	21	38 U	38 U	38 U	39 UJ
Aroclor-1242	UG/KG	0	0%		0	0	20	38 U	38 U	38 U	39 UJ
Aroclor-1248	UG/KG	0	0%		0	0	21	38 U	38 U	38 U	39 UJ
Aroclor-1254	UG/KG	0	0%	10000	0	0	21	38 U	38 U	38 U	39 UJ
Aroclor-1260	UG/KG	0	0%	10000	0	0	21	38 U	38 U	38 U	39 UJ
Metals											
Aluminum	MG/KG	15200	100%	19300	0	21	21	7450	5895	9660	9340
Antimony	MG/KG	0.47	14%	5.9	0	3	21	0.64 UJ	0.585 UJ	0.64 UJ	0.26 J
Arsenic	MG/KG	6	100%	8.2	0	21	21	3.9	3.2	3	3.8
Barium	MG/KG	192	100%	300	0	21	21	52.7	37.9	71.7	66
Beryllium	MG/KG	0.52	100%	1.1	0	21	21	0.23	0.185	0.32	0.42 J
Cadmium	MG/KG	0.61	24%	2.3	0	5	21	0.09 U	0.085 U	0.09 U	0.41 J
Calcium	MG/KG	123000	100%	121000	1	21	21	123000	94900	95900	65800
Chromium	MG/KG	20.7	100%	29.6	0	21	21	12.7	9.6	14.2	15.5
Cobalt	MG/KG	14.2	100%	30	0	21	21	8.1	6.6	7.1	9.1
Copper	MG/KG	36.1	100%	33	1	21	21	19.1	17.5	18.6	19.7
Cyanide	MG/KG	0	0%	0.35	0	0	21	0.58 UJ	0.6 UJ	0.58 UJ	0.59 U
Iron	MG/KG	28900	100%	36500	0	21	21	16900	13550	16500	20900

Table A-2B
SUBSURFACE SOIL SAMPLE RESULTS (2-15 ft.)
SEAD-59
SEAD-59 and SEAD-71 Phase II RI Report
Seneca Army Depot Activity

	SEAD-59	SEAD-59	SEAD-59	SEAD-59
Facility	SB59-15	SB59-17	SB59-18	SB59-2
Location ID	SOIL	SOIL	SOIL	SOIL
Maxtrix	59061	59068/59131	59127	SB59-2-04
Sample ID	4	8	10	6
Sample Depth to Top of Sample ⁽¹⁾	5.3	9.2	11	7
Sample Depth to Bottom of Sample ⁽¹⁾	10/21/1997	35726	10/24/1997	5/26/1994
Sample Date	SA	SA/DU	SA	SA
QC Code	RI PHASE 1 STEP 1	RI PHASE 1 STEP 1	RI PHASE 1 STEP 1	ESI
Study ID				

Parameter	Units	Maximum	Frequency of	NYSDEC	Number of	Number of	Number of	Value (Q)	Value (Q)	Value (Q)	Value (Q)
		Value	Detection	TAGM 4046 ⁽²⁾	Exceedances	Detects	Analyses ⁽³⁾				
Lead	MG/KG	65.5	100%	24.8	7	21	21	8.3	6.25	19.6	12.9
Magnesium	MG/KG	34400	100%	21500	1	21	21	14900	14500	17200	9190
Manganese	MG/KG	1150	100%	1060	1	21	21	469	362.5	378	836
Mercury	MG/KG	0.32	50%	0.1	4	10	20	0.06 U	0.05 U	0.07	0.04 J
Nickel	MG/KG	35.5	100%	49	0	21	21	23.8	18.45	20.9	24.7
Potassium	MG/KG	2520	100%	2380	1	21	21	1160	1083	1940	1280 J
Selenium	MG/KG	1.5	24%	2	0	5	21	0.89 U	0.81 U	0.88 U	0.49 J
Silver	MG/KG	0.25	5%	0.75	0	1	21	0.24 U	0.225 U	0.24 U	0.08 UJ
Sodium	MG/KG	1150	81%	172	6	17	21	817	158.5	258	148 J
Thallium	MG/KG	0	0%	0.7	0	0	21	0.91 UJ	0.825 UJ	0.9 UJ	0.29 U
Vanadium	MG/KG	26.3	100%	150	0	21	21	12.9	11.1	19.1	16.4
Zinc	MG/KG	133	100%	110	2	21	21	67.1	57.9	50	75.5

Note(s):

- (1) - Historical sample depths are presented (I.e. prior to 2002 TCRA)
- (2) - NYSDEC Technical and Administrative Guidance Memorandum (TAGM) HWR-94-4046, Revised January 24, 1994
- (3) - Sample/Duplicate pair are presented as individual samples in this table. Statistical information used Sample Duplicate pairs as a single entity and averaged result values were used in risk assessment analysis.

U = compound was not detected

J = the reported value is an estimated concentration

UJ = the compound was not detected; the associated reporting limit is approximate

R = the data was rejected in the data validating process

NJ = compound was "tentatively identified" and the associated numerical value is approximate

Table A-2B
SUBSURFACE SOIL SAMPLE RESULTS (2-15 ft.)
SEAD-59
SEAD-59 and SEAD-71 Phase II RI Report
Seneca Army Depot Activity

Facility	SEAD-59	SEAD-59	SEAD-59	SEAD-59
Location ID	SB59-21	SB59-5	SB59-8	SB59-9
Maxtrix	SOIL	SOIL	SOIL	SOIL
Sample ID	59067	SB59-5-06	59057	59059
Sample Depth to Top of Sample ⁽¹⁾	0	10	0	2
Sample Depth to Bottom of Sample ⁽¹⁾	1.1	12	2	3.7
Sample Date	10/22/1997	5/25/1994	10/20/1997	10/21/1997
QC Code	SA	SA	SA	SA
Study ID	RI PHASE 1 STEP 1	ESI	RI PHASE 1 STEP 1	RI PHASE 1 STEP 1

Parameter	Units	Maximum	Frequency of	NYSDEC	Number of	Number of	Number of	Value (Q)	Value (Q)	Value (Q)	Value (Q)
		Value	Detection	TAGM 4046 ⁽²⁾	Exceedances	Detects	Analyses ⁽³⁾				
Volatile Organics											
1,1,1-Trichloroethane	UG/KG	0	0%	800	0	0	21	12 U	11 U	13 U	10 U
1,1,2,2-Tetrachloroethane	UG/KG	0	0%	600	0	0	21	12 U	11 U	13 U	10 U
1,1,2-Trichloro-1,2,2-Trifluoroethane	UG/KG	0	0%		0	0	0				
1,1,2-Trichloroethane	UG/KG	0	0%		0	0	21	12 U	11 U	13 U	10 U
1,1-Dichloroethane	UG/KG	0	0%	200	0	0	21	12 U	11 U	13 U	10 U
1,1-Dichloroethene	UG/KG	0	0%	400	0	0	21	12 U	11 U	13 U	10 U
1,2,3-Trichloropropane	UG/KG	0	0%		0	0	0				
1,2,4-Trichlorobenzene	UG/KG	0	0%	3400	0	0	0				
1,2-Dibromo-3-chloropropane	UG/KG	0	0%		0	0	0				
1,2-Dibromoethane	UG/KG	0	0%		0	0	0				
1,2-Dichlorobenzene	UG/KG	0	0%	7900	0	0	0				
1,2-Dichloroethane	UG/KG	0	0%	100	0	0	21	12 U	11 U	13 U	10 U
1,2-Dichloroethene (total)	UG/KG	0	0%		0	0	21	12 U	11 U	13 U	10 U
1,2-Dichloropropane	UG/KG	0	0%		0	0	21	12 U	11 U	13 U	10 U
1,3-Dichlorobenzene	UG/KG	0	0%	1600	0	0	0				
1,3-Dichloropropane	UG/KG	0	0%		0	0	0				
1,4-Dichlorobenzene	UG/KG	0	0%	8500	0	0	0				
Acetone	UG/KG	30	5%	200	0	1	21	12 U	11 U	13 U	10 U
Benzene	UG/KG	8.5	5%	60	0	1	21	12 U	11 U	13 U	10 U
Bromodichloromethane	UG/KG	0	0%		0	0	21	12 U	11 U	13 U	10 U
Bromoform	UG/KG	0	0%		0	0	21	12 U	11 U	13 U	10 U
Carbon disulfide	UG/KG	0	0%	2700	0	0	21	12 U	11 U	13 U	10 U
Carbon tetrachloride	UG/KG	0	0%	600	0	0	21	12 U	11 U	13 U	10 U
Chlorobenzene	UG/KG	0	0%	1700	0	0	21	12 U	11 U	13 U	10 U
Chlorodibromomethane	UG/KG	0	0%		0	0	21	12 U	11 U	13 U	10 U
Chloroethane	UG/KG	0	0%	1900	0	0	21	12 U	11 U	13 U	10 U
Chloroform	UG/KG	0	0%	300	0	0	21	12 U	11 U	13 U	10 U
Cis-1,2-Dichloroethene	UG/KG	0	0%		0	0	0				
Cis-1,3-Dichloropropene	UG/KG	0	0%		0	0	21	12 U	11 U	13 U	10 U
Cyclohexane	UG/KG	0	0%		0	0	0				
Dichlorodifluoromethane	UG/KG	0	0%		0	0	0				
Ethyl benzene	UG/KG	110	10%	5500	0	2	21	12 U	11 U	13 U	10 U
Isopropylbenzene	UG/KG	0	10%		0	0	0				
Meta/Para Xylene	UG/KG	0	10%		0	0	0				
Methyl Acetate	UG/KG	0	10%		0	0	0				
Methyl Tertbutyl Ether	UG/KG	0	10%		0	0	0				
Methyl bromide	UG/KG	0	0%		0	0	21	12 U	11 U	13 U	10 U
Methyl butyl ketone	UG/KG	0	0%		0	0	21	12 U	11 U	13 U	10 U
Methyl chloride	UG/KG	3	5%		0	1	21	12 U	11 U	13 U	10 U
Methyl cyclohexane	UG/KG	0	5%		0	0	0				
Methyl ethyl ketone	UG/KG	36	14%	300	0	3	21	12 U	11 U	13 U	10 U
Methyl isobutyl ketone	UG/KG	0	0%	1000	0	0	21	12 U	11 U	13 U	10 U

Table A-2B
SUBSURFACE SOIL SAMPLE RESULTS (2-15 ft.)
SEAD-59
SEAD-59 and SEAD-71 Phase II RI Report
Seneca Army Depot Activity

Facility	SEAD-59	SEAD-59	SEAD-59	SEAD-59
Location ID	SB59-21	SB59-5	SB59-8	SB59-9
Maxtrix	SOIL	SOIL	SOIL	SOIL
Sample ID	59067	SB59-5-06	59057	59059
Sample Depth to Top of Sample ⁽¹⁾	0	10	0	2
Sample Depth to Bottom of Sample ⁽¹⁾	1.1	12	2	3.7
Sample Date	10/22/1997	5/25/1994	10/20/1997	10/21/1997
QC Code	SA	SA	SA	SA
Study ID	RI PHASE 1 STEP 1	ESI	RI PHASE 1 STEP 1	RI PHASE 1 STEP 1

Parameter	Units	Maximum Value	Frequency of Detection	NYSDEC TAGM 4046 ⁽²⁾	Number of Exceedances	Number of Detects	Number of Analyses ⁽³⁾	Value (Q)	Value (Q)	Value (Q)	Value (Q)
Methylene chloride	UG/KG	1	5%	100	0	1	21	12 U	11 U	13 U	10 U
Ortho Xylene	UG/KG	0	5%		0	0	0				
Styrene	UG/KG	0	0%		0	0	21	12 U	11 U	13 U	10 U
Tetrachloroethene	UG/KG	0	0%	1400	0	0	21	12 U	11 U	13 U	10 U
Toluene	UG/KG	13.5	14%	1500	0	3	21	12 U	11 U	13 U	10 U
Total BTEX	MG/KG	9.5	93%		0	14	15	6.5		6.3	4.6
Total Xylenes	UG/KG	75.5	5%	1200	0	1	21	12 U	11 U	13 U	10 U
Trans-1,2-Dichloroethene	UG/KG	0	5%	300	0	0	0				
Trans-1,3-Dichloropropene	UG/KG	0	0%		0	0	21	12 U	11 U	13 U	10 U
Trichloroethene	UG/KG	0	0%	700	0	0	21	12 U	11 U	13 U	10 U
Trichlorofluoromethane	UG/KG	0	0%		0	0	0				
Vinyl chloride	UG/KG	0	0%	200	0	0	21	12 U	11 U	13 U	10 U
Semivolatiles Organics											
1,1'-Biphenyl	UG/KG	0	0%		0	0	0				
1,2,4-Trichlorobenzene	UG/KG	0	0%	3400	0	0	21	66 U	380 U	81 U	69 U
1,2-Dichlorobenzene	UG/KG	0	0%	7900	0	0	21	66 U	380 U	81 U	69 U
1,3-Dichlorobenzene	UG/KG	0	0%	1600	0	0	21	66 U	380 U	81 U	69 U
1,4-Dichlorobenzene	UG/KG	0	0%	8500	0	0	21	66 U	380 U	81 U	69 U
2,2'-oxybis(1-Chloropropane)	UG/KG	0	0%		0	0	5			380 U	
2,4,5-Trichlorophenol	UG/KG	0	0%	100	0	0	21	160 U	920 U	200 U	170 U
2,4,6-Trichlorophenol	UG/KG	0	0%		0	0	21	66 UJ	380 U	81 U	69 U
2,4-Dichlorophenol	UG/KG	0	0%	400	0	0	21	66 U	380 U	81 U	69 U
2,4-Dimethylphenol	UG/KG	0	0%		0	0	21	66 U	380 U	81 U	69 U
2,4-Dinitrophenol	UG/KG	0	0%	200	0	0	21	160 UJ	920 U	200 U	170 U
2,4-Dinitrotoluene	UG/KG	0	0%		0	0	21	66 U	380 U	81 U	69 U
2,6-Dinitrotoluene	UG/KG	0	0%	1000	0	0	21	66 U	380 U	81 U	69 U
2-Chloronaphthalene	UG/KG	0	0%		0	0	21	66 U	380 U	81 U	69 U
2-Chlorophenol	UG/KG	0	0%	800	0	0	21	66 U	380 U	81 U	69 U
2-Methylnaphthalene	UG/KG	10000	57%	36400	0	12	21	66 U	380 U	81 U	69 U
2-Methylphenol	UG/KG	0	0%	100	0	0	21	66 U	380 U	81 U	69 U
2-Nitroaniline	UG/KG	0	0%	430	0	0	21	160 U	920 U	200 U	170 U
2-Nitrophenol	UG/KG	0	0%	330	0	0	21	66 U	380 U	81 U	69 U
3,3'-Dichlorobenzidine	UG/KG	0	0%		0	0	21	66 UJ	380 U	81 U	69 U
3-Nitroaniline	UG/KG	0	0%	500	0	0	21	160 UJ	920 U	200 U	170 U
4,6-Dinitro-2-methylphenol	UG/KG	0	0%		0	0	21	160 U	920 U	200 U	170 U
4-Bromophenyl phenyl ether	UG/KG	0	0%		0	0	21	66 U	380 U	81 U	69 U
4-Chloro-3-methylphenol	UG/KG	0	0%	240	0	0	21	66 U	380 U	81 U	69 U
4-Chloroaniline	UG/KG	0	0%	220	0	0	21	66 UJ	380 U	81 U	69 U
4-Chlorophenyl phenyl ether	UG/KG	0	0%		0	0	21	66 U	380 U	81 U	69 U
4-Methylphenol	UG/KG	83	10%	900	0	2	21	66 U	380 U	81 U	69 U
4-Nitroaniline	UG/KG	0	0%		0	0	21	160 U	920 U	200 U	170 U
4-Nitrophenol	UG/KG	0	0%	100	0	0	21	160 U	920 U	200 U	170 U
Acenaphthene	UG/KG	1600	57%	50000	0	12	21	66 U	380 U	81 U	69 U

Table A-2B
SUBSURFACE SOIL SAMPLE RESULTS (2-15 ft.)
SEAD-59
SEAD-59 and SEAD-71 Phase II RI Report
Seneca Army Depot Activity

Facility	SEAD-59	SEAD-59	SEAD-59	SEAD-59
Location ID	SB59-21	SB59-5	SB59-8	SB59-9
Maxtrix	SOIL	SOIL	SOIL	SOIL
Sample ID	59067	SB59-5-06	59057	59059
Sample Depth to Top of Sample ⁽¹⁾	0	10	0	2
Sample Depth to Bottom of Sample ⁽¹⁾	1.1	12	2	3.7
Sample Date	10/22/1997	5/25/1994	10/20/1997	10/21/1997
QC Code	SA	SA	SA	SA
Study ID	RI PHASE 1 STEP 1	ESI	RI PHASE 1 STEP 1	RI PHASE 1 STEP 1

Parameter	Units	Maximum	Frequency of	NYSDEC	Number of	Number of	Number of	Value (Q)	Value (Q)	Value (Q)	Value (Q)
		Value	Detection	TAGM 4046 ⁽²⁾	Exceedances	Detects	Analyses ⁽³⁾				
Acenaphthylene	UG/KG	460	48%	41000	0	10	21	66 U	380 U	81 U	69 U
Acetophenone	UG/KG	0	48%		0	0	0				
Aniline	UG/KG	0	48%		0	0	0				
Anthracene	UG/KG	2100	48%	50000	0	10	21	66 U	380 U	81 U	69 U
Atrazine	UG/KG	0	48%		0	0	0				
Benzaldehyde	UG/KG	0	48%		0	0	0				
Benzo(a)anthracene	UG/KG	4200	67%	224	7	14	21	9.6 J	380 U	6.6 J	69 U
Benzo(a)pyrene	UG/KG	4600	67%	61	9	14	21	8.1 J	380 U	7 J	69 U
Benzo(b)fluoranthene	UG/KG	4400	76%	1100	3	16	21	15 J	380 U	7.7 J	4.8 J
Benzo(ghi)perylene	UG/KG	2400	62%	50000	0	13	21	11 J	380 U	6.3 J	69 U
Benzo(k)fluoranthene	UG/KG	4900	62%	1100	3	13	21	12 J	380 U	8.4 J	69 U
Benzoic Acid	UG/KG	0	62%	2700	0	0	0				
Bis(2-Chloroethoxy)methane	UG/KG	0	0%		0	0	21	66 U	380 U	81 U	69 U
Bis(2-Chloroethyl)ether	UG/KG	0	0%		0	0	21	66 U	380 U	81 U	69 U
Bis(2-Chloroisopropyl)ether	UG/KG	0	0%		0	0	16	66 U		81 U	69 U
Bis(2-Ethylhexyl)phthalate	UG/KG	260	71%	50000	0	15	21	21 J	380 U	69 J	24 J
Butylbenzylphthalate	UG/KG	1000	10%	50000	0	2	21	66 U	380 U	81 U	69 U
Caprolactam	UG/KG	0	10%		0	0	0				
Carbazole	UG/KG	1500	52%		0	11	21	6.6 J	380 U	81 U	69 U
Chrysene	UG/KG	4400	71%	400	5	15	21	14 J	380 U	7.8 J	69 U
Di-n-butylphthalate	UG/KG	29	43%	8100	0	9	21	4.8 J	380 U	5.8 J	7.1 J
Di-n-octylphthalate	UG/KG	11	10%	50000	0	2	21	66 U	380 U	11 J	69 U
Dibenz(a,h)anthracene	UG/KG	890	38%	14	7	8	21	66 U	380 U	81 U	69 U
Dibenzofuran	UG/KG	1400	48%	6200	0	10	21	66 U	380 U	81 U	69 U
Diethyl phthalate	UG/KG	12	38%	7100	0	8	21	8.1 J	380 U	10 J	12 J
Dimethylphthalate	UG/KG	0	0%	2000	0	0	21	66 U	380 U	81 U	69 U
Fluoranthene	UG/KG	10000	71%	50000	0	15	21	28 J	380 U	11 J	69 U
Fluorene	UG/KG	3000	52%	50000	0	11	21	66 U	380 U	81 U	69 U
Hexachlorobenzene	UG/KG	0	0%	410	0	0	21	66 U	380 U	81 U	69 U
Hexachlorobutadiene	UG/KG	0	0%		0	0	21	66 U	380 U	81 U	69 U
Hexachlorocyclopentadiene	UG/KG	0	0%		0	0	21	66 U	380 U	81 U	69 U
Hexachloroethane	UG/KG	0	0%		0	0	21	66 U	380 U	81 U	69 U
Indeno(1,2,3-cd)pyrene	UG/KG	2300	62%	3200	0	13	21	9.6 J	380 U	6 J	69 U
Isophorone	UG/KG	0	0%	4400	0	0	21	66 U	380 U	81 U	69 U
N-Nitrosodiphenylamine	UG/KG	0	0%		0	0	21	66 U	380 U	81 U	69 U
N-Nitrosodipropylamine	UG/KG	0	0%		0	0	21	66 U	380 U	81 U	69 U
Naphthalene	UG/KG	750	48%	13000	0	10	21	66 U	380 U	81 U	69 U
Nitrobenzene	UG/KG	0	0%	200	0	0	21	66 U	380 U	81 U	69 U
Pentachlorophenol	UG/KG	0	0%	1000	0	0	21	160 UJ	920 U	200 U	170 U
Phenanthrene	UG/KG	8300	81%	50000	0	17	21	20 J	380 U	6 J	69 U
Phenol	UG/KG	17	5%	30	0	1	21	66 U	380 U	81 U	69 U
Pyrene	UG/KG	12000	80%	50000	0	16	20	21 J	380 U	13 J	69 U
Pyridine	UG/KG	0	80%		0	0	0				

Table A-2B
SUBSURFACE SOIL SAMPLE RESULTS (2-15 ft.)
SEAD-59
SEAD-59 and SEAD-71 Phase II RI Report
Seneca Army Depot Activity

Facility	SEAD-59	SEAD-59	SEAD-59	SEAD-59
Location ID	SB59-21	SB59-5	SB59-8	SB59-9
Maxtrix	SOIL	SOIL	SOIL	SOIL
Sample ID	59067	SB59-5-06	59057	59059
Sample Depth to Top of Sample ⁽¹⁾	0	10	0	2
Sample Depth to Bottom of Sample ⁽¹⁾	1.1	12	2	3.7
Sample Date	10/22/1997	5/25/1994	10/20/1997	10/21/1997
QC Code	SA	SA	SA	SA
Study ID	RI PHASE 1 STEP 1	ESI	RI PHASE 1 STEP 1	RI PHASE 1 STEP 1

Parameter	Units	Maximum Value	Frequency of Detection	NYSDEC TAGM 4046 ⁽²⁾	Number of Exceedances	Number of Detects	Number of Analyses ⁽³⁾	Value (Q)	Value (Q)	Value (Q)	Value (Q)
Total Unknown PAHs as SV	MG/KG	25	36%		0	5	14	0.6 U		0.6 U	0.8
Pesticides/PCBs											
4,4'-DDD	UG/KG	70	29%	2900	0	6	21	4.2 U	3.8 U	4.1 U	3.5 U
4,4'-DDE	UG/KG	48	48%	2100	0	10	21	4.2 U	3.8 U	4.1 U	2.5 J
4,4'-DDT	UG/KG	59	33%	2100	0	7	21	4.2 U	3.8 U	4.1 U	3.9
Aldrin	UG/KG	0	0%	41	0	0	21	2.2 U	2 U	2.1 U	1.8 U
Alpha-BHC	UG/KG	9.9	10%	110	0	2	21	2.2 U	2 U	9	8.2 UJ
Alpha-Chlordane	UG/KG	17	10%		0	2	21	2.2 U	2 U	2.1 U	1.8 U
Beta-BHC	UG/KG	3.6	24%	200	0	5	21	2.2 U	2 U	3.6 J	3 J
Delta-BHC	UG/KG	1.4	19%	300	0	4	21	2.2 U	2 U	1.4 J	1.1 J
Dieldrin	UG/KG	1.8	5%	44	0	1	21	4.2 U	3.8 U	4.1 U	3.5 U
Endosulfan I	UG/KG	4.1	5%	900	0	1	21	2.2 U	2 U	2.1 U	1.8 U
Endosulfan II	UG/KG	7.1	5%	900	0	1	21	4.2 U	3.8 U	4.1 U	3.5 U
Endosulfan sulfate	UG/KG	4.3	5%	1000	0	1	21	4.2 U	3.8 U	4.1 U	3.5 U
Endrin	UG/KG	7.7	5%	100	0	1	21	4.2 U	3.8 U	4.1 U	3.5 U
Endrin aldehyde	UG/KG	6.3	14%		0	3	21	4.2 U	3.8 U	4.1 U	3.5 U
Endrin ketone	UG/KG	4.4	5%		0	1	21	4.2 U	3.8 U	4.1 U	3.5 U
Gamma-BHC/Lindane	UG/KG	0	0%	60	0	0	21	2.2 U	2 U	2.9 U	2.6 UJ
Gamma-Chlordane	UG/KG	18	10%	540	0	2	21	2.2 U	2 U	2.1 U	1.8 U
Heptachlor	UG/KG	0	0%	100	0	0	21	2.2 U	2 U	2.1 U	1.8 U
Heptachlor epoxide	UG/KG	5.7	14%	20	0	3	21	2.2 U	2 U	2.1 U	1.8 U
Methoxychlor	UG/KG	0	0%		0	0	21	22 U	20 U	21 U	18 U
Toxaphene	UG/KG	0	0%		0	0	21	220 U	200 U	210 U	180 U
Aroclor-1016	UG/KG	0	0%		0	0	21	42 U	38 U	41 U	35 U
Aroclor-1221	UG/KG	0	0%		0	0	21	85 U	77 U	84 U	70 U
Aroclor-1232	UG/KG	0	0%		0	0	21	42 U	38 U	41 U	35 U
Aroclor-1242	UG/KG	0	0%		0	0	20	42 U	38 U	41 U	35 U
Aroclor-1248	UG/KG	0	0%		0	0	21	42 U	38 U	41 U	35 U
Aroclor-1254	UG/KG	0	0%	10000	0	0	21	42 U	38 U	41 U	35 U
Aroclor-1260	UG/KG	0	0%	10000	0	0	21	42 U	38 U	41 U	35 U
Metals											
Aluminum	MG/KG	15200	100%	19300	0	21	21	14300	7030	15200	7180
Antimony	MG/KG	0.47	14%	5.9	0	3	21	0.68 UJ	0.18 UJ	0.69 UJ	0.58 UJ
Arsenic	MG/KG	6	100%	8.2	0	21	21	5.2	5.1	5.2	3.8
Barium	MG/KG	192	100%	300	0	21	21	167	36 J	192	47.9
Beryllium	MG/KG	0.52	100%	1.1	0	21	21	0.44	0.42 J	0.36	0.25
Cadmium	MG/KG	0.61	24%	2.3	0	5	21	0.09 U	0.61 J	0.1 U	0.08 U
Calcium	MG/KG	123000	100%	121000	1	21	21	5450	85200	7390	91000
Chromium	MG/KG	20.7	100%	29.6	0	21	21	20.7	13.1	20.7	11.9
Cobalt	MG/KG	14.2	100%	30	0	21	21	11.3	8.1 J	12.5	8.1
Copper	MG/KG	36.1	100%	33	1	21	21	25	18.8	28.4	18.7
Cyanide	MG/KG	0	0%	0.35	0	0	21	0.75 UJ	0.56 U	0.65 UJ	0.53 UJ
Iron	MG/KG	28900	100%	36500	0	21	21	24700	18100	26300	16100

Table A-2B
SUBSURFACE SOIL SAMPLE RESULTS (2-15 ft.)
SEAD-59
SEAD-59 and SEAD-71 Phase II RI Report
Seneca Army Depot Activity

Facility	SEAD-59	SEAD-59	SEAD-59	SEAD-59
Location ID	SB59-21	SB59-5	SB59-8	SB59-9
Maxtrix	SOIL	SOIL	SOIL	SOIL
Sample ID	59067	SB59-5-06	59057	59059
Sample Depth to Top of Sample ⁽¹⁾	0	10	0	2
Sample Depth to Bottom of Sample ⁽¹⁾	1.1	12	2	3.7
Sample Date	10/22/1997	5/25/1994	10/20/1997	10/21/1997
QC Code	SA	SA	SA	SA
Study ID	RI PHASE 1 STEP 1	ESI	RI PHASE 1 STEP 1	RI PHASE 1 STEP 1

Parameter	Units	Maximum	Frequency of	NYSDEC	Number of	Number of	Number of	Value (Q)	Value (Q)	Value (Q)	Value (Q)
		Value	Detection	TAGM 4046 ⁽²⁾	Exceedances	Detects	Analyses ⁽³⁾				
Lead	MG/KG	65.5	100%	24.8	7	21	21	58.6	12.3 J	55.5	8.5
Magnesium	MG/KG	34400	100%	21500	1	21	21	4300	34400	4740	18300
Manganese	MG/KG	1150	100%	1060	1	21	21	1050	477	1150	385
Mercury	MG/KG	0.32	50%	0.1	4	10	20	0.32	0.04 J	0.21	0.05 U
Nickel	MG/KG	35.5	100%	49	0	21	21	28.8	27	28.5	21.4
Potassium	MG/KG	2520	100%	2380	1	21	21	1600	922 J	1770	1430
Selenium	MG/KG	1.5	24%	2	0	5	21	1.5	0.31 U	1.4	0.79 U
Silver	MG/KG	0.25	5%	0.75	0	1	21	0.26 U	0.13 UJ	0.26 U	0.22 U
Sodium	MG/KG	1150	81%	172	6	17	21	113 U	274 J	115 U	142
Thallium	MG/KG	0	0%	0.7	0	0	21	0.97 UJ	0.29 U	0.98 UJ	0.81 UJ
Vanadium	MG/KG	26.3	100%	150	0	21	21	23.1	13.3	25.4	13.7
Zinc	MG/KG	133	100%	110	2	21	21	87	64.9	86	61.2

Note(s):

- (1) - Historical sample depths are presented (I.e. prior to 2002 TCRA)
- (2) - NYSDEC Technical and Administrative Guidance Memorandum (TAGM) HWR-94-4046, Revised January 24, 1994
- (3) - Sample/Duplicate pair are presented as individual samples in this table. Statistical information used Sample Duplicate pairs as a single entity and averaged result values were used in risk assessment analysis.

U = compound was not detected

J = the reported value is an estimated concentration

UJ = the compound was not detected; the associated reporting limit is approximate

R = the data was rejected in the data validating process

NJ = compound was "tentatively identified" and the associated numerical value is approximate

Table A-2B
SUBSURFACE SOIL SAMPLE RESULTS (2-15 ft.)
SEAD-59
SEAD-59 and SEAD-71 Phase II RI Report
Seneca Army Depot Activity

Facility	SEAD-59	SEAD-59	SEAD-59	SEAD-59
Location ID	SB59-9	TP59-11A-2	TP59-13A-1	TP59-13C-1
Maxtrix	SOIL	SOIL	SOIL	SOIL
Sample ID	59085/59089	59026	59010	59015
Sample Depth to Top of Sample ⁽¹⁾	4	4	3.5	3
Sample Depth to Bottom of Sample ⁽¹⁾	5.1	4.5	4	3.5
Sample Date	35725	10/9/1997	10/8/1997	10/8/1997
QC Code	SA/DU	SA	SA	SA
Study ID	RI PHASE 1 STEP 1	RI PHASE 1 STEP 1	RI PHASE 1 STEP 1	RI PHASE 1 STEP 1

Parameter	Units	Maximum Value	Frequency of Detection	NYSDEC TAGM 4046 ⁽²⁾	Number of Exceedances	Number of Detects	Number of Analyses ⁽³⁾	Value (Q)	Value (Q)	Value (Q)	Value (Q)
Volatile Organics											
1,1,1-Trichloroethane	UG/KG	0	0%	800	0	0	21		11 U	120 U	11 U
1,1,2,2-Tetrachloroethane	UG/KG	0	0%	600	0	0	21		11 U	120 U	11 U
1,1,2-Trichloro-1,2,2-Trifluoroethane	UG/KG	0	0%		0	0	0				
1,1,2-Trichloroethane	UG/KG	0	0%		0	0	21		11 U	120 U	11 U
1,1-Dichloroethane	UG/KG	0	0%	200	0	0	21		11 U	120 U	11 U
1,1-Dichloroethene	UG/KG	0	0%	400	0	0	21		11 U	120 U	11 U
1,2,3-Trichloropropane	UG/KG	0	0%		0	0	0				
1,2,4-Trichlorobenzene	UG/KG	0	0%	3400	0	0	0				
1,2-Dibromo-3-chloropropane	UG/KG	0	0%		0	0	0				
1,2-Dibromoethane	UG/KG	0	0%		0	0	0				
1,2-Dichlorobenzene	UG/KG	0	0%	7900	0	0	0				
1,2-Dichloroethane	UG/KG	0	0%	100	0	0	21		11 U	120 U	11 U
1,2-Dichloroethene (total)	UG/KG	0	0%		0	0	21		11 U	120 U	11 U
1,2-Dichloropropane	UG/KG	0	0%		0	0	21		11 U	120 U	11 U
1,3-Dichlorobenzene	UG/KG	0	0%	1600	0	0	0				
1,3-Dichloropropane	UG/KG	0	0%		0	0	0				
1,4-Dichlorobenzene	UG/KG	0	0%	8500	0	0	0				
Acetone	UG/KG	30	5%	200	0	1	21		7 U	120 U	11 U
Benzene	UG/KG	8.5	5%	60	0	1	21		7 U	120 U	11 U
Bromodichloromethane	UG/KG	0	0%		0	0	21		11 U	120 U	11 U
Bromoform	UG/KG	0	0%		0	0	21		11 U	120 U	11 U
Carbon disulfide	UG/KG	0	0%	2700	0	0	21		11 U	120 U	11 U
Carbon tetrachloride	UG/KG	0	0%	600	0	0	21		11 U	120 U	11 U
Chlorobenzene	UG/KG	0	0%	1700	0	0	21		11 U	120 U	11 U
Chlorodibromomethane	UG/KG	0	0%		0	0	21		11 U	120 U	11 U
Chloroethane	UG/KG	0	0%	1900	0	0	21		11 U	120 U	11 U
Chloroform	UG/KG	0	0%	300	0	0	21		11 U	120 U	11 U
Cis-1,2-Dichloroethene	UG/KG	0	0%		0	0	0				
Cis-1,3-Dichloropropene	UG/KG	0	0%		0	0	21		11 U	120 U	11 U
Cyclohexane	UG/KG	0	0%		0	0	0				
Dichlorodifluoromethane	UG/KG	0	0%		0	0	0				
Ethyl benzene	UG/KG	110	10%	5500	0	2	21		11 U	110 J	11 U
Isopropylbenzene	UG/KG	0	10%		0	0	0				
Meta/Para Xylene	UG/KG	0	10%		0	0	0				
Methyl Acetate	UG/KG	0	10%		0	0	0				
Methyl Tertbutyl Ether	UG/KG	0	10%		0	0	0				
Methyl bromide	UG/KG	0	0%		0	0	21		11 U	120 U	11 U
Methyl butyl ketone	UG/KG	0	0%		0	0	21		11 U	120 U	11 U
Methyl chloride	UG/KG	3	5%		0	1	21		11 U	120 U	11 U
Methyl cyclohexane	UG/KG	0	5%		0	0	0				
Methyl ethyl ketone	UG/KG	36	14%	300	0	3	21		11 U	120 U	11 U
Methyl isobutyl ketone	UG/KG	0	0%	1000	0	0	21		11 U	120 U	11 U

Table A-2B
SUBSURFACE SOIL SAMPLE RESULTS (2-15 ft.)
SEAD-59
SEAD-59 and SEAD-71 Phase II RI Report
Seneca Army Depot Activity

Facility	SEAD-59	SEAD-59	SEAD-59	SEAD-59
Location ID	SB59-9	TP59-11A-2	TP59-13A-1	TP59-13C-1
Maxtrix	SOIL	SOIL	SOIL	SOIL
Sample ID	59085/59089	59026	59010	59015
Sample Depth to Top of Sample ⁽¹⁾	4	4	3.5	3
Sample Depth to Bottom of Sample ⁽¹⁾	5.1	4.5	4	3.5
Sample Date	35725	10/9/1997	10/8/1997	10/8/1997
QC Code	SA/DU	SA	SA	SA
Study ID	RI PHASE 1 STEP 1	RI PHASE 1 STEP 1	RI PHASE 1 STEP 1	RI PHASE 1 STEP 1

Parameter	Units	Maximum Value	Frequency of Detection	NYSDEC TAGM 4046 ⁽²⁾	Number of Exceedances	Number of Detects	Number of Analyses ⁽³⁾	Value (Q)	Value (Q)	Value (Q)	Value (Q)
Methylene chloride	UG/KG	1	5%	100	0	1	21		11 U	120 U	11 U
Ortho Xylene	UG/KG	0	5%		0	0	0				
Styrene	UG/KG	0	0%		0	0	21		11 U	120 U	11 U
Tetrachloroethene	UG/KG	0	0%	1400	0	0	21		11 U	120 U	11 U
Toluene	UG/KG	13.5	14%	1500	0	3	21		11 U	120 U	11 U
Total BTEX	MG/KG	9.5	93%		0	14	15	3.3 J	2.5		9.5
Total Xylenes	UG/KG	75.5	5%	1200	0	1	21		11 U	120 U	11 U
Trans-1,2-Dichloroethene	UG/KG	0	5%	300	0	0	0				
Trans-1,3-Dichloropropene	UG/KG	0	0%		0	0	21		11 U	120 U	11 U
Trichloroethene	UG/KG	0	0%	700	0	0	21		11 U	120 U	11 U
Trichlorofluoromethane	UG/KG	0	0%		0	0	0				
Vinyl chloride	UG/KG	0	0%	200	0	0	21		11 U	120 U	11 U
Semivolatile Organics											
1,1'-Biphenyl	UG/KG	0	0%		0	0	0				
1,2,4-Trichlorobenzene	UG/KG	0	0%	3400	0	0	21		1400 U	8000 U	76 U
1,2-Dichlorobenzene	UG/KG	0	0%	7900	0	0	21		1400 U	8000 U	76 U
1,3-Dichlorobenzene	UG/KG	0	0%	1600	0	0	21		1400 U	8000 U	76 U
1,4-Dichlorobenzene	UG/KG	0	0%	8500	0	0	21		1400 U	8000 U	76 U
2,2'-oxybis(1-Chloropropane)	UG/KG	0	0%		0	0	5				
2,4,5-Trichlorophenol	UG/KG	0	0%	100	0	0	21		3500 U	20000 U	180 U
2,4,6-Trichlorophenol	UG/KG	0	0%		0	0	21		1400 U	8000 U	76 U
2,4-Dichlorophenol	UG/KG	0	0%	400	0	0	21		1400 U	8000 U	76 U
2,4-Dimethylphenol	UG/KG	0	0%		0	0	21		1400 U	8000 U	76 U
2,4-Dinitrophenol	UG/KG	0	0%	200	0	0	21		3500 U	20000 U	180 U
2,4-Dinitrotoluene	UG/KG	0	0%		0	0	21		1400 U	8000 U	76 U
2,6-Dinitrotoluene	UG/KG	0	0%	1000	0	0	21		1400 U	8000 U	76 U
2-Chloronaphthalene	UG/KG	0	0%		0	0	21		1400 U	8000 U	76 U
2-Chlorophenol	UG/KG	0	0%	800	0	0	21		1400 U	8000 U	76 U
2-Methylnaphthalene	UG/KG	10000	57%	36400	0	12	21		210 J	10000	76 U
2-Methylphenol	UG/KG	0	0%	100	0	0	21		1400 U	8000 U	76 U
2-Nitroaniline	UG/KG	0	0%	430	0	0	21		3500 U	20000 U	180 U
2-Nitrophenol	UG/KG	0	0%	330	0	0	21		1400 U	8000 U	76 U
3,3'-Dichlorobenzidine	UG/KG	0	0%		0	0	21		1400 U	8000 U	76 UJ
3-Nitroaniline	UG/KG	0	0%	500	0	0	21		3500 U	20000 U	180 UJ
4,6-Dinitro-2-methylphenol	UG/KG	0	0%		0	0	21		3500 U	20000 U	180 U
4-Bromophenyl phenyl ether	UG/KG	0	0%		0	0	21		1400 U	8000 U	76 U
4-Chloro-3-methylphenol	UG/KG	0	0%	240	0	0	21		1400 U	8000 U	76 U
4-Chloroaniline	UG/KG	0	0%	220	0	0	21		1400 U	8000 U	76 U
4-Chlorophenyl phenyl ether	UG/KG	0	0%		0	0	21		1400 U	8000 U	76 U
4-Methylphenol	UG/KG	83	10%	900	0	2	21		1400 U	8000 U	76 U
4-Nitroaniline	UG/KG	0	0%		0	0	21		3500 U	20000 U	180 U
4-Nitrophenol	UG/KG	0	0%	100	0	0	21		3500 U	20000 U	180 U
Acenaphthene	UG/KG	1600	57%	50000	0	12	21		340 J	1600 J	76 U

Table A-2B
SUBSURFACE SOIL SAMPLE RESULTS (2-15 ft.)
SEAD-59
SEAD-59 and SEAD-71 Phase II RI Report
Seneca Army Depot Activity

Facility	SEAD-59	SEAD-59	SEAD-59	SEAD-59
Location ID	SB59-9	TP59-11A-2	TP59-13A-1	TP59-13C-1
Maxtrix	SOIL	SOIL	SOIL	SOIL
Sample ID	59085/59089	59026	59010	59015
Sample Depth to Top of Sample ⁽¹⁾	4	4	3.5	3
Sample Depth to Bottom of Sample ⁽¹⁾	5.1	4.5	4	3.5
Sample Date	35725	10/9/1997	10/8/1997	10/8/1997
QC Code	SA/DU	SA	SA	SA
Study ID	RI PHASE 1 STEP 1	RI PHASE 1 STEP 1	RI PHASE 1 STEP 1	RI PHASE 1 STEP 1

Parameter	Units	Maximum Value	Frequency of Detection	NYSDEC TAGM 4046 ⁽²⁾	Number of Exceedances	Number of Detects	Number of Analyses ⁽³⁾	Value (Q)	Value (Q)	Value (Q)	Value (Q)
Acenaphthylene	UG/KG	460	48%	41000	0	10	21		290 J	8000 U	76 U
Acetophenone	UG/KG	0	48%		0	0	0				
Aniline	UG/KG	0	48%		0	0	0				
Anthracene	UG/KG	2100	48%	50000	0	10	21		1100 J	8000 U	76 U
Atrazine	UG/KG	0	48%		0	0	0				
Benzaldehyde	UG/KG	0	48%		0	0	0				
Benzo(a)anthracene	UG/KG	4200	67%	224	7	14	21		3500	8000 U	8.2 J
Benzo(a)pyrene	UG/KG	4600	67%	61	9	14	21		4100	8000 U	10 J
Benzo(b)fluoranthene	UG/KG	4400	76%	1100	3	16	21		3400	8000 U	11 J
Benzo(ghi)perylene	UG/KG	2400	62%	50000	0	13	21		2400	8000 U	7.7 J
Benzo(k)fluoranthene	UG/KG	4900	62%	1100	3	13	21		3200	8000 U	10 J
Benzoic Acid	UG/KG	0	62%	2700	0	0	0				
Bis(2-Chloroethoxy)methane	UG/KG	0	0%		0	0	21		1400 U	8000 U	76 U
Bis(2-Chloroethyl)ether	UG/KG	0	0%		0	0	21		1400 U	8000 U	76 U
Bis(2-Chloroisopropyl)ether	UG/KG	0	0%		0	0	16		1400 U	8000 U	76 U
Bis(2-Ethylhexyl)phthalate	UG/KG	260	71%	50000	0	15	21		1400 U	8000 U	7 J
Butylbenzylphthalate	UG/KG	1000	10%	50000	0	2	21		1400 U	8000 U	76 U
Caprolactam	UG/KG	0	10%		0	0	0				
Carbazole	UG/KG	1500	52%		0	11	21		610 J	8000 U	76 U
Chrysene	UG/KG	4400	71%	400	5	15	21		3700	8000 U	12 J
Di-n-butylphthalate	UG/KG	29	43%	8100	0	9	21		1400 U	8000 U	76 U
Di-n-octylphthalate	UG/KG	11	10%	50000	0	2	21		1400 U	8000 U	76 U
Dibenz(a,h)anthracene	UG/KG	890	38%	14	7	8	21		890 J	8000 U	76 U
Dibenzofuran	UG/KG	1400	48%	6200	0	10	21		230 J	1400 J	76 U
Diethyl phthalate	UG/KG	12	38%	7100	0	8	21		1400 U	8000 U	5.3 J
Dimethylphthalate	UG/KG	0	0%	2000	0	0	21		1400 U	8000 U	76 U
Fluoranthene	UG/KG	10000	71%	50000	0	15	21		7300	8000 U	14 J
Fluorene	UG/KG	3000	52%	50000	0	11	21		640 J	3000 J	76 U
Hexachlorobenzene	UG/KG	0	0%	410	0	0	21		1400 U	8000 U	76 U
Hexachlorobutadiene	UG/KG	0	0%		0	0	21		1400 U	8000 U	76 U
Hexachlorocyclopentadiene	UG/KG	0	0%		0	0	21		1400 U	8000 U	76 U
Hexachloroethane	UG/KG	0	0%		0	0	21		1400 U	8000 U	76 U
Indeno(1,2,3-cd)pyrene	UG/KG	2300	62%	3200	0	13	21		2300	8000 U	7.5 J
Isophorone	UG/KG	0	0%	4400	0	0	21		1400 U	8000 U	76 U
N-Nitrosodiphenylamine	UG/KG	0	0%		0	0	21		1400 U	8000 U	76 U
N-Nitrosodipropylamine	UG/KG	0	0%		0	0	21		1400 U	8000 U	76 U
Naphthalene	UG/KG	750	48%	13000	0	10	21		110 J	8000 U	76 U
Nitrobenzene	UG/KG	0	0%	200	0	0	21		1400 U	8000 U	76 U
Pentachlorophenol	UG/KG	0	0%	1000	0	0	21		3500 U	20000 U	180 U
Phenanthrene	UG/KG	8300	81%	50000	0	17	21		5000	5200 J	8.9 J
Phenol	UG/KG	17	5%	30	0	1	21		1400 U	8000 U	76 U
Pyrene	UG/KG	12000	80%	50000	0	16	20		7000	8000 U	14 J
Pyridine	UG/KG	0	80%		0	0	0				

Table A-2B
SUBSURFACE SOIL SAMPLE RESULTS (2-15 ft.)
SEAD-59
SEAD-59 and SEAD-71 Phase II RI Report
Seneca Army Depot Activity

Facility	SEAD-59	SEAD-59	SEAD-59	SEAD-59
Location ID	SB59-9	TP59-11A-2	TP59-13A-1	TP59-13C-1
Maxtrix	SOIL	SOIL	SOIL	SOIL
Sample ID	59085/59089	59026	59010	59015
Sample Depth to Top of Sample ⁽¹⁾	4	4	3.5	3
Sample Depth to Bottom of Sample ⁽¹⁾	5.1	4.5	4	3.5
Sample Date	35725	10/9/1997	10/8/1997	10/8/1997
QC Code	SA/DU	SA	SA	SA
Study ID	RI PHASE 1 STEP 1	RI PHASE 1 STEP 1	RI PHASE 1 STEP 1	RI PHASE 1 STEP 1

Parameter	Units	Maximum Value	Frequency of Detection	NYSDEC TAGM 4046 ⁽²⁾	Number of Exceedances	Number of Detects	Number of Analyses ⁽³⁾	Value (Q)	Value (Q)	Value (Q)	Value (Q)
Total Unknown PAHs as SV	MG/KG	25	36%		0	5	14	0.6 U	25 J		0.6 U
Pesticides/PCBs											
4,4'-DDD	UG/KG	70	29%	2900	0	6	21		13	26	3.8 U
4,4'-DDE	UG/KG	48	48%	2100	0	10	21		13	10	3.8 U
4,4'-DDT	UG/KG	59	33%	2100	0	7	21		12	4 U	3.8 U
Aldrin	UG/KG	0	0%	41	0	0	21		1.8 U	2.1 U	2 U
Alpha-BHC	UG/KG	9.9	10%	110	0	2	21		1.8 U	2.1 U	2 U
Alpha-Chlordane	UG/KG	17	10%		0	2	21		1.1 J	17	2 U
Beta-BHC	UG/KG	3.6	24%	200	0	5	21		1.8 U	2.1 U	2 U
Delta-BHC	UG/KG	1.4	19%	300	0	4	21		1.8 U	2.1 U	2 U
Dieldrin	UG/KG	1.8	5%	44	0	1	21		3.6 U	4 U	3.8 U
Endosulfan I	UG/KG	4.1	5%	900	0	1	21		1.8 U	2.1 U	2 U
Endosulfan II	UG/KG	7.1	5%	900	0	1	21		3.6 U	4 U	3.8 U
Endosulfan sulfate	UG/KG	4.3	5%	1000	0	1	21		3.6 U	4 U	3.8 U
Endrin	UG/KG	7.7	5%	100	0	1	21		7.7	4 U	3.8 U
Endrin aldehyde	UG/KG	6.3	14%		0	3	21		3.5 J	4 U	3.8 U
Endrin ketone	UG/KG	4.4	5%		0	1	21		4.4	4 U	3.8 U
Gamma-BHC/Lindane	UG/KG	0	0%	60	0	0	21		1.8 U	2.1 U	2 U
Gamma-Chlordane	UG/KG	18	10%	540	0	2	21		1 J	18	2 U
Heptachlor	UG/KG	0	0%	100	0	0	21		1.8 U	2.1 U	2 U
Heptachlor epoxide	UG/KG	5.7	14%	20	0	3	21		1 J	2.1 U	2 U
Methoxychlor	UG/KG	0	0%		0	0	21		18 U	21 U	20 U
Toxaphene	UG/KG	0	0%		0	0	21		180 U	210 U	200 U
Aroclor-1016	UG/KG	0	0%		0	0	21		36 U	40 U	38 U
Aroclor-1221	UG/KG	0	0%		0	0	21		73 U	82 U	77 U
Aroclor-1232	UG/KG	0	0%		0	0	21		36 U	40 U	38 U
Aroclor-1242	UG/KG	0	0%		0	0	20		36 U	40 U	38 U
Aroclor-1248	UG/KG	0	0%		0	0	21		36 U	40 U	38 U
Aroclor-1254	UG/KG	0	0%	10000	0	0	21		36 U	40 U	38 U
Aroclor-1260	UG/KG	0	0%	10000	0	0	21		36 U	40 U	38 U
Metals											
Aluminum	MG/KG	15200	100%	19300	0	21	21		9950 J	9510 J	6630 J
Antimony	MG/KG	0.47	14%	5.9	0	3	21		0.56 UJ	0.51 UJ	0.6 UJ
Arsenic	MG/KG	6	100%	8.2	0	21	21		3.5	4.8	3.6
Barium	MG/KG	192	100%	300	0	21	21		77.8	33.2	33.6
Beryllium	MG/KG	0.52	100%	1.1	0	21	21		0.39	0.46	0.25
Cadmium	MG/KG	0.61	24%	2.3	0	5	21		0.08 U	0.07 U	0.08 U
Calcium	MG/KG	123000	100%	121000	1	21	21		98900	8570	73900
Chromium	MG/KG	20.7	100%	29.6	0	21	21		16.4	17.5	11.6
Cobalt	MG/KG	14.2	100%	30	0	21	21		9.5	13.8	9
Copper	MG/KG	36.1	100%	33	1	21	21		36.1	27	15.8
Cyanide	MG/KG	0	0%	0.35	0	0	21		0.58 U	0.65 U	0.57 U
Iron	MG/KG	28900	100%	36500	0	21	21		18200	22200	15400

Table A-2B
SUBSURFACE SOIL SAMPLE RESULTS (2-15 ft.)
SEAD-59
SEAD-59 and SEAD-71 Phase II RI Report
Seneca Army Depot Activity

Facility	SEAD-59	SEAD-59	SEAD-59	SEAD-59
Location ID	SB59-9	TP59-11A-2	TP59-13A-1	TP59-13C-1
Maxtrix	SOIL	SOIL	SOIL	SOIL
Sample ID	59085/59089	59026	59010	59015
Sample Depth to Top of Sample ⁽¹⁾	4	4	3.5	3
Sample Depth to Bottom of Sample ⁽¹⁾	5.1	4.5	4	3.5
Sample Date	3/5/1997	10/9/1997	10/8/1997	10/8/1997
QC Code	SA/DU	SA	SA	SA
Study ID	RI PHASE 1 STEP 1	RI PHASE 1 STEP 1	RI PHASE 1 STEP 1	RI PHASE 1 STEP 1

Parameter	Units	Maximum Value	Frequency of Detection	NYSDEC TAGM 4046 ⁽²⁾	Number of Exceedances	Number of Detects	Number of Analyses ⁽³⁾	Value (Q)	Value (Q)	Value (Q)	Value (Q)
Lead	MG/KG	65.5	100%	24.8	7	21	21	65.2 J	17.6 J	11.1 J	
Magnesium	MG/KG	34400	100%	21500	1	21	21	8970 J	6250 J	7700 J	
Manganese	MG/KG	1150	100%	1060	1	21	21	442 J	285 J	340 J	
Mercury	MG/KG	0.32	50%	0.1	4	10	20	0.15	0.05 U	0.05 U	
Nickel	MG/KG	35.5	100%	49	0	21	21	26.8	35	21.5	
Potassium	MG/KG	2520	100%	2380	1	21	21	1540	1090	1000	
Selenium	MG/KG	1.5	24%	2	0	5	21	0.78 U	0.71 U	0.83 U	
Silver	MG/KG	0.25	5%	0.75	0	1	21	0.25	0.2 U	0.23 U	
Sodium	MG/KG	1150	81%	172	6	17	21	99.5	1150	385	
Thallium	MG/KG	0	0%	0.7	0	0	21	1.2 U	1.1 U	1.2 U	
Vanadium	MG/KG	26.3	100%	150	0	21	21	18.7	16	11.6	
Zinc	MG/KG	133	100%	110	2	21	21	90.9 J	97.2 J	69.7 J	

Note(s):

- (1) - Historical sample depths are presented (I.e. prior to 2002 TCRA)
- (2) - NYSDEC Technical and Administrative Guidance Memorandum (TAGM) HWR-94-4046, Revised January 24, 1994
- (3) - Sample/Duplicate pair are presented as individual samples in this table. Statistical information used Sample Duplicate pairs as a single entity and averaged result values were used in risk assessment analysis.

U = compound was not detected

J = the reported value is an estimated concentration

UJ = the compound was not detected; the associated reporting limit is approximate

R = the data was rejected in the data validating process

NJ = compound was "tentatively identified" and the associated numerical value is approximate

Table A-2B
SUBSURFACE SOIL SAMPLE RESULTS (2-15 ft.)
SEAD-59
SEAD-59 and SEAD-71 Phase II RI Report
Seneca Army Depot Activity

Facility	SEAD-59	SEAD-59	SEAD-59	SEAD-59
Location ID	TP59-15-5	TP59-16-1	TP59-2	TP59-5
Maxtrix	SOIL	SOIL	SOIL	SOIL
Sample ID	59035	59036	TP59-2	TP59-5
Sample Depth to Top of Sample ⁽¹⁾	6	3.5	7	2.5
Sample Depth to Bottom of Sample ⁽¹⁾	6.5	4	7	2.5
Sample Date	10/10/1997	10/10/1997	2/20/1994	6/8/1994
QC Code	SA	SA	SA	SA
Study ID	RI PHASE 1 STEP 1	RI PHASE 1 STEP 1	ESI	ESI

Parameter	Units	Maximum	Frequency of	NYSDEC	Number of	Number of	Number of	Value (Q)	Value (Q)	Value (Q)	Value (Q)
		Value	Detection	TAGM 4046 ⁽²⁾	Exceedances	Detects	Analyses ⁽³⁾				
Volatile Organics											
1,1,1-Trichloroethane	UG/KG	0	0%	800	0	0	21	12 U	13 U	11 U	12 U
1,1,2,2-Tetrachloroethane	UG/KG	0	0%	600	0	0	21	12 U	13 U	11 U	12 U
1,1,2-Trichloro-1,2,2-Trifluoroethane	UG/KG	0	0%		0	0	0				
1,1,2-Trichloroethane	UG/KG	0	0%		0	0	21	12 U	13 U	11 U	12 U
1,1-Dichloroethane	UG/KG	0	0%	200	0	0	21	12 U	13 U	11 U	12 U
1,1-Dichloroethene	UG/KG	0	0%	400	0	0	21	12 U	13 U	11 U	12 U
1,2,3-Trichloropropane	UG/KG	0	0%		0	0	0				
1,2,4-Trichlorobenzene	UG/KG	0	0%	3400	0	0	0				
1,2-Dibromo-3-chloropropane	UG/KG	0	0%		0	0	0				
1,2-Dibromoethane	UG/KG	0	0%		0	0	0				
1,2-Dichlorobenzene	UG/KG	0	0%	7900	0	0	0				
1,2-Dichloroethane	UG/KG	0	0%	100	0	0	21	12 U	13 U	11 U	12 U
1,2-Dichloroethene (total)	UG/KG	0	0%		0	0	21	12 U	13 U	11 U	12 U
1,2-Dichloropropane	UG/KG	0	0%		0	0	21	12 U	13 U	11 U	12 U
1,3-Dichlorobenzene	UG/KG	0	0%	1600	0	0	0				
1,3-Dichloropropane	UG/KG	0	0%		0	0	0				
1,4-Dichlorobenzene	UG/KG	0	0%	8500	0	0	0				
Acetone	UG/KG	30	5%	200	0	1	21	12 U	13 U	17 U	30
Benzene	UG/KG	8.5	5%	60	0	1	21	12 U	13 U	11 U	12 U
Bromodichloromethane	UG/KG	0	0%		0	0	21	12 U	13 U	11 U	12 U
Bromoform	UG/KG	0	0%		0	0	21	12 U	13 U	11 U	12 U
Carbon disulfide	UG/KG	0	0%	2700	0	0	21	12 U	13 U	11 U	12 U
Carbon tetrachloride	UG/KG	0	0%	600	0	0	21	12 U	13 U	11 U	12 U
Chlorobenzene	UG/KG	0	0%	1700	0	0	21	12 U	13 U	11 U	12 U
Chlorodibromomethane	UG/KG	0	0%		0	0	21	12 U	13 U	11 U	12 U
Chloroethane	UG/KG	0	0%	1900	0	0	21	12 U	13 U	11 U	12 U
Chloroform	UG/KG	0	0%	300	0	0	21	12 U	13 U	11 U	12 U
Cis-1,2-Dichloroethene	UG/KG	0	0%		0	0	0				
Cis-1,3-Dichloropropene	UG/KG	0	0%		0	0	21	12 U	13 U	11 U	12 U
Cyclohexane	UG/KG	0	0%		0	0	0				
Dichlorodifluoromethane	UG/KG	0	0%		0	0	0				
Ethyl benzene	UG/KG	110	10%	5500	0	2	21	12 U	13 U	11 U	12 U
Isopropylbenzene	UG/KG	0	10%		0	0	0				
Meta/Para Xylene	UG/KG	0	10%		0	0	0				
Methyl Acetate	UG/KG	0	10%		0	0	0				
Methyl Tertbutyl Ether	UG/KG	0	10%		0	0	0				
Methyl bromide	UG/KG	0	0%		0	0	21	12 U	13 U	11 U	12 U
Methyl butyl ketone	UG/KG	0	0%		0	0	21	12 U	13 U	11 U	12 U
Methyl chloride	UG/KG	3	5%		0	1	21	12 U	13 U	11 U	3 J
Methyl cyclohexane	UG/KG	0	5%		0	0	0				
Methyl ethyl ketone	UG/KG	36	14%	300	0	3	21	12 U	30	11 U	12
Methyl isobutyl ketone	UG/KG	0	0%	1000	0	0	21	12 U	13 U	11 U	12 U

Table A-2B
SUBSURFACE SOIL SAMPLE RESULTS (2-15 ft.)
SEAD-59
SEAD-59 and SEAD-71 Phase II RI Report
Seneca Army Depot Activity

Facility	SEAD-59	SEAD-59	SEAD-59	SEAD-59
Location ID	TP59-15-5	TP59-16-1	TP59-2	TP59-5
Maxtrix	SOIL	SOIL	SOIL	SOIL
Sample ID	59035	59036	TP59-2	TP59-5
Sample Depth to Top of Sample ⁽¹⁾	6	3.5	7	2.5
Sample Depth to Bottom of Sample ⁽¹⁾	6.5	4	7	2.5
Sample Date	10/10/1997	10/10/1997	2/20/1994	6/8/1994
QC Code	SA	SA	SA	SA
Study ID	RI PHASE 1 STEP 1	RI PHASE 1 STEP 1	ESI	ESI

Parameter	Units	Maximum Value	Frequency of Detection	NYSDEC TAGM 4046 ⁽²⁾	Number of Exceedances	Number of Detects	Number of Analyses ⁽³⁾	Value (Q)	Value (Q)	Value (Q)	Value (Q)
Methylene chloride	UG/KG	1	5%	100	0	1	21	12 U	13 U	11 U	1 J
Ortho Xylene	UG/KG	0	5%		0	0	0				
Styrene	UG/KG	0	0%		0	0	21	12 U	13 U	11 U	12 U
Tetrachloroethene	UG/KG	0	0%	1400	0	0	21	12 U	13 U	11 U	12 U
Toluene	UG/KG	13.5	14%	1500	0	3	21	2 J	13 U	11 U	2 J
Total BTEX	MG/KG	9.5	93%		0	14	15	6	2.5 U		
Total Xylenes	UG/KG	75.5	5%	1200	0	1	21	12 U	13 U	11 U	12 U
Trans-1,2-Dichloroethene	UG/KG	0	5%	300	0	0	0				
Trans-1,3-Dichloropropene	UG/KG	0	0%		0	0	21	12 U	13 U	11 U	12 U
Trichloroethene	UG/KG	0	0%	700	0	0	21	12 U	13 U	11 U	12 U
Trichlorofluoromethane	UG/KG	0	0%		0	0	0				
Vinyl chloride	UG/KG	0	0%	200	0	0	21	12 U	13 U	11 U	12 U
Semivolatile Organics											
1,1'-Biphenyl	UG/KG	0	0%		0	0	0				
1,2,4-Trichlorobenzene	UG/KG	0	0%	3400	0	0	21	1500 U	78 U	1800 U	390 U
1,2-Dichlorobenzene	UG/KG	0	0%	7900	0	0	21	1500 U	78 U	1800 U	390 U
1,3-Dichlorobenzene	UG/KG	0	0%	1600	0	0	21	1500 U	78 U	1800 U	390 U
1,4-Dichlorobenzene	UG/KG	0	0%	8500	0	0	21	1500 U	78 U	1800 U	390 U
2,2'-oxybis(1-Chloropropane)	UG/KG	0	0%		0	0	5			1800 U	390 U
2,4,5-Trichlorophenol	UG/KG	0	0%	100	0	0	21	3700 U	190 U	4500 U	940 U
2,4,6-Trichlorophenol	UG/KG	0	0%		0	0	21	1500 U	78 U	1800 U	390 U
2,4-Dichlorophenol	UG/KG	0	0%	400	0	0	21	1500 U	78 U	1800 U	390 U
2,4-Dimethylphenol	UG/KG	0	0%		0	0	21	1500 U	78 U	1800 U	390 U
2,4-Dinitrophenol	UG/KG	0	0%	200	0	0	21	3700 UJ	190 U	4500 U	940 U
2,4-Dinitrotoluene	UG/KG	0	0%		0	0	21	1500 U	78 U	1800 U	390 U
2,6-Dinitrotoluene	UG/KG	0	0%	1000	0	0	21	1500 U	78 U	1800 U	390 U
2-Chloronaphthalene	UG/KG	0	0%		0	0	21	1500 U	78 U	1800 U	390 U
2-Chlorophenol	UG/KG	0	0%	800	0	0	21	1500 U	78 U	1800 U	390 U
2-Methylnaphthalene	UG/KG	10000	57%	36400	0	12	21	100 J	16 J	400 J	390 U
2-Methylphenol	UG/KG	0	0%	100	0	0	21	1500 U	78 U	1800 U	390 U
2-Nitroaniline	UG/KG	0	0%	430	0	0	21	3700 U	190 U	4500 U	940 U
2-Nitrophenol	UG/KG	0	0%	330	0	0	21	1500 U	78 U	1800 U	390 U
3,3'-Dichlorobenzidine	UG/KG	0	0%		0	0	21	1500 U	78 UJ	1800 U	390 U
3-Nitroaniline	UG/KG	0	0%	500	0	0	21	3700 U	190 UJ	4500 U	940 U
4,6-Dinitro-2-methylphenol	UG/KG	0	0%		0	0	21	3700 U	190 U	4500 U	940 U
4-Bromophenyl phenyl ether	UG/KG	0	0%		0	0	21	1500 U	78 U	1800 U	390 U
4-Chloro-3-methylphenol	UG/KG	0	0%	240	0	0	21	1500 U	78 U	1800 U	390 U
4-Chloroaniline	UG/KG	0	0%	220	0	0	21	1500 U	78 U	1800 U	390 U
4-Chlorophenyl phenyl ether	UG/KG	0	0%		0	0	21	1500 U	78 U	1800 U	390 U
4-Methylphenol	UG/KG	83	10%	900	0	2	21	1500 U	78 U	1800 U	390 U
4-Nitroaniline	UG/KG	0	0%		0	0	21	3700 U	190 U	4500 U	940 U
4-Nitrophenol	UG/KG	0	0%	100	0	0	21	3700 U	190 UJ	4500 U	940 U
Acenaphthene	UG/KG	1600	57%	50000	0	12	21	270 J	19 J	870 J	390 U

Table A-2B
SUBSURFACE SOIL SAMPLE RESULTS (2-15 ft.)
SEAD-59
SEAD-59 and SEAD-71 Phase II RI Report
Seneca Army Depot Activity

Facility	SEAD-59	SEAD-59	SEAD-59	SEAD-59
Location ID	TP59-15-5	TP59-16-1	TP59-2	TP59-5
Maxtrix	SOIL	SOIL	SOIL	SOIL
Sample ID	59035	59036	TP59-2	TP59-5
Sample Depth to Top of Sample ⁽¹⁾	6	3.5	7	2.5
Sample Depth to Bottom of Sample ⁽¹⁾	6.5	4	7	2.5
Sample Date	10/10/1997	10/10/1997	2/20/1994	6/8/1994
QC Code	SA	SA	SA	SA
Study ID	RI PHASE 1 STEP 1	RI PHASE 1 STEP 1	ESI	ESI

Parameter	Units	Maximum Value	Frequency of Detection	NYSDEC TAGM 4046 ⁽²⁾	Number of Exceedances	Number of Detects	Number of Analyses ⁽³⁾	Value (Q)	Value (Q)	Value (Q)	Value (Q)
Acenaphthylene	UG/KG	460	48%	41000	0	10	21	130 J	9.9 J	460 J	390 U
Acetophenone	UG/KG	0	48%		0	0	0				
Aniline	UG/KG	0	48%		0	0	0				
Anthracene	UG/KG	2100	48%	50000	0	10	21	390 J	27 J	2100	390 U
Atrazine	UG/KG	0	48%		0	0	0				
Benzaldehyde	UG/KG	0	48%		0	0	0				
Benzo(a)anthracene	UG/KG	4200	67%	224	7	14	21	3200	210	4200	390 U
Benzo(a)pyrene	UG/KG	4600	67%	61	9	14	21	3600	220	4600	390 U
Benzo(b)fluoranthene	UG/KG	4400	76%	1100	3	16	21	3200	250	4400	390 U
Benzo(ghi)perylene	UG/KG	2400	62%	50000	0	13	21	2300	160	1400 J	390 U
Benzo(k)fluoranthene	UG/KG	4900	62%	1100	3	13	21	3100	180	4900	390 U
Benzoic Acid	UG/KG	0	62%	2700	0	0	0				
Bis(2-Chloroethoxy)methane	UG/KG	0	0%		0	0	21	1500 U	78 U	1800 U	390 U
Bis(2-Chloroethyl)ether	UG/KG	0	0%		0	0	21	1500 U	78 U	1800 U	390 U
Bis(2-Chloroisopropyl)ether	UG/KG	0	0%		0	0	16	1500 U	78 U		
Bis(2-Ethylhexyl)phthalate	UG/KG	260	71%	50000	0	15	21	1500 U	17 J	1800 U	46 J
Butylbenzylphthalate	UG/KG	1000	10%	50000	0	2	21	1000 J	4.2 J	1800 U	390 U
Caprolactam	UG/KG	0	10%		0	0	0				
Carbazole	UG/KG	1500	52%		0	11	21	590 J	34 J	1500 J	390 U
Chrysene	UG/KG	4400	71%	400	5	15	21	4400	240	4400	390 U
Di-n-butylphthalate	UG/KG	29	43%	8100	0	9	21	1500 U	78 U	1800 U	390 U
Di-n-octylphthalate	UG/KG	11	10%	50000	0	2	21	1500 U	5.6 J	1800 UJ	390 U
Dibenz(a,h)anthracene	UG/KG	890	38%	14	7	8	21	710 J	74 J	1800 UJ	390 U
Dibenzofuran	UG/KG	1400	48%	6200	0	10	21	140 J	78 U	1800 U	390 U
Diethyl phthalate	UG/KG	12	38%	7100	0	8	21	1500 U	78 U	1800 U	390 U
Dimethylphthalate	UG/KG	0	0%	2000	0	0	21	1500 U	78 U	1800 U	390 U
Fluoranthene	UG/KG	10000	71%	50000	0	15	21	8600	430	10000	390 U
Fluorene	UG/KG	3000	52%	50000	0	11	21	620 J	78 U	1300 J	390 U
Hexachlorobenzene	UG/KG	0	0%	410	0	0	21	1500 U	78 U	1800 U	390 U
Hexachlorobutadiene	UG/KG	0	0%		0	0	21	1500 U	78 U	1800 U	390 U
Hexachlorocyclopentadiene	UG/KG	0	0%		0	0	21	1500 U	78 U	1800 U	390 U
Hexachloroethane	UG/KG	0	0%		0	0	21	1500 U	78 U	1800 U	390 U
Indeno(1,2,3-cd)pyrene	UG/KG	2300	62%	3200	0	13	21	2000	160	1500 J	390 U
Isophorone	UG/KG	0	0%	4400	0	0	21	1500 U	78 U	1800 U	390 U
N-Nitrosodiphenylamine	UG/KG	0	0%		0	0	21	1500 U	78 U	1800 U	390 U
N-Nitrosodipropylamine	UG/KG	0	0%		0	0	21	1500 U	78 U	1800 U	390 U
Naphthalene	UG/KG	750	48%	13000	0	10	21	1500 U	10 J	290 J	390 U
Nitrobenzene	UG/KG	0	0%	200	0	0	21	1500 U	78 U	1800 U	390 U
Pentachlorophenol	UG/KG	0	0%	1000	0	0	21	3700 UJ	190 U	4500 U	940 U
Phenanthrene	UG/KG	8300	81%	50000	0	17	21	6500	160	8300	390 U
Phenol	UG/KG	17	5%	30	0	1	21	1500 U	78 U	1800 U	390 U
Pyrene	UG/KG	12000	80%	50000	0	16	20	8000	370	12000	
Pyridine	UG/KG	0	80%		0	0	0				

Table A-2B
SUBSURFACE SOIL SAMPLE RESULTS (2-15 ft.)
SEAD-59
SEAD-59 and SEAD-71 Phase II RI Report
Seneca Army Depot Activity

Facility	SEAD-59	SEAD-59	SEAD-59	SEAD-59
Location ID	TP59-15-5	TP59-16-1	TP59-2	TP59-5
Maxtrix	SOIL	SOIL	SOIL	SOIL
Sample ID	59035	59036	TP59-2	TP59-5
Sample Depth to Top of Sample ⁽¹⁾	6	3.5	7	2.5
Sample Depth to Bottom of Sample ⁽¹⁾	6.5	4	7	2.5
Sample Date	10/10/1997	10/10/1997	2/20/1994	6/8/1994
QC Code	SA	SA	SA	SA
Study ID	RI PHASE 1 STEP 1	RI PHASE 1 STEP 1	ESI	ESI

Parameter	Units	Maximum Value	Frequency of Detection	NYSDEC TAGM 4046 ⁽²⁾	Number of Exceedances	Number of Detects	Number of Analyses ⁽³⁾	Value (Q)	Value (Q)	Value (Q)	Value (Q)
Total Unknown PAHs as SV	MG/KG	25	36%		0	5	14	25 J	0.6 U		
Pesticides/PCBs											
4,4'-DDD	UG/KG	70	29%	2900	0	6	21	3.8 U	3.9 U	15	3.9 U
4,4'-DDE	UG/KG	48	48%	2100	0	10	21	3.8 U	3.9 U	26 J	3.9 U
4,4'-DDT	UG/KG	59	33%	2100	0	7	21	3.8 U	3.9 U	20 J	3.9 U
Aldrin	UG/KG	0	0%	41	0	0	21	2 U	2 U	3.8 U	2 U
Alpha-BHC	UG/KG	9.9	10%	110	0	2	21	2 U	2 U	3.8 U	2 U
Alpha-Chlordane	UG/KG	17	10%		0	2	21	2 U	2 U	3.8 U	2 U
Beta-BHC	UG/KG	3.6	24%	200	0	5	21	2 U	2 U	3.8 U	2 U
Delta-BHC	UG/KG	1.4	19%	300	0	4	21	2 U	2 U	3.8 U	2 U
Dieldrin	UG/KG	1.8	5%	44	0	1	21	3.8 U	3.9 U	7.3 U	3.9 U
Endosulfan I	UG/KG	4.1	5%	900	0	1	21	2 U	2 U	3.8 U	2 U
Endosulfan II	UG/KG	7.1	5%	900	0	1	21	3.8 U	3.9 U	7.1 J	3.9 U
Endosulfan sulfate	UG/KG	4.3	5%	1000	0	1	21	3.8 U	3.9 U	7.3 U	3.9 U
Endrin	UG/KG	7.7	5%	100	0	1	21	3.8 U	3.9 U	7.3 U	3.9 U
Endrin aldehyde	UG/KG	6.3	14%		0	3	21	3.8 U	3.9 U	6.3 J	3.9 U
Endrin ketone	UG/KG	4.4	5%		0	1	21	3.8 U	3.9 U	7.3 U	3.9 U
Gamma-BHC/Lindane	UG/KG	0	0%	60	0	0	21	2 U	2 U	3.8 U	2 U
Gamma-Chlordane	UG/KG	18	10%	540	0	2	21	2 U	2 U	3.8 U	2 U
Heptachlor	UG/KG	0	0%	100	0	0	21	2 U	2 U	3.8 U	2 U
Heptachlor epoxide	UG/KG	5.7	14%	20	0	3	21	2 U	2 U	2.2 J	2 U
Methoxychlor	UG/KG	0	0%		0	0	21	20 U	20 U	38 U	20 U
Toxaphene	UG/KG	0	0%		0	0	21	200 U	200 U	380 U	200 U
Aroclor-1016	UG/KG	0	0%		0	0	21	38 U	39 U	73 U	39 U
Aroclor-1221	UG/KG	0	0%		0	0	21	77 U	80 U	150 U	79 U
Aroclor-1232	UG/KG	0	0%		0	0	21	38 U	39 U	73 U	39 U
Aroclor-1242	UG/KG	0	0%		0	0	20	38 U	39 U		39 U
Aroclor-1248	UG/KG	0	0%		0	0	21	38 U	39 U	73 U	39 U
Aroclor-1254	UG/KG	0	0%	10000	0	0	21	38 U	39 U	73 U	39 U
Aroclor-1260	UG/KG	0	0%	10000	0	0	21	38 U	39 U	73 U	39 U
Metals											
Aluminum	MG/KG	15200	100%	19300	0	21	21	11900 J	12400 J	10200 J	8730 J
Antimony	MG/KG	0.47	14%	5.9	0	3	21	0.62 UJ	0.6 UJ	0.47 J	0.25 UJ
Arsenic	MG/KG	6	100%	8.2	0	21	21	4.1	3.8	4.8 J	4.1
Barium	MG/KG	192	100%	300	0	21	21	72.6	94.4	52.6 J	72 J
Beryllium	MG/KG	0.52	100%	1.1	0	21	21	0.45	0.45	0.43 J	0.33 J
Cadmium	MG/KG	0.61	24%	2.3	0	5	21	0.09 U	0.08 U	0.4 J	0.38 J
Calcium	MG/KG	123000	100%	121000	1	21	21	29200	5590	42700 J	77700 J
Chromium	MG/KG	20.7	100%	29.6	0	21	21	18.4	18.9	16.9 J	13.2 J
Cobalt	MG/KG	14.2	100%	30	0	21	21	8.9	9.8	9.1 J	6.3 J
Copper	MG/KG	36.1	100%	33	1	21	21	28.1	20.2	24 J	17.2 J
Cyanide	MG/KG	0	0%	0.35	0	0	21	0.61 U	0.66 U	0.55 U	0.45 U
Iron	MG/KG	28900	100%	36500	0	21	21	21300	22700	19700 J	16800 J

Table A-2B
SUBSURFACE SOIL SAMPLE RESULTS (2-15 ft.)
SEAD-59
SEAD-59 and SEAD-71 Phase II RI Report
Seneca Army Depot Activity

Facility	SEAD-59	SEAD-59	SEAD-59	SEAD-59
Location ID	TP59-15-5	TP59-16-1	TP59-2	TP59-5
Maxtrix	SOIL	SOIL	SOIL	SOIL
Sample ID	59035	59036	TP59-2	TP59-5
Sample Depth to Top of Sample ⁽¹⁾	6	3.5	7	2.5
Sample Depth to Bottom of Sample ⁽¹⁾	6.5	4	7	2.5
Sample Date	10/10/1997	10/10/1997	2/20/1994	6/8/1994
QC Code	SA	SA	SA	SA
Study ID	RI PHASE 1 STEP 1	RI PHASE 1 STEP 1	ESI	ESI

Parameter	Units	Maximum	Frequency of	NYSDEC	Number of	Number of	Number of	Value (Q)	Value (Q)	Value (Q)	Value (Q)
		Value	Detection	TAGM 4046 ⁽²⁾	Exceedances	Detects	Analyses ⁽³⁾				
Lead	MG/KG	65.5	100%	24.8	7	21	21	47 J	13.9 J	29.7 J	10.2
Magnesium	MG/KG	34400	100%	21500	1	21	21	9520 J	4810 J	6380 J	15400 J
Manganese	MG/KG	1150	100%	1060	1	21	21	496 J	561 J	425 J	326 J
Mercury	MG/KG	0.32	50%	0.1	4	10	20	0.05 U	0.05 U	0.04 J	0.05 JR
Nickel	MG/KG	35.5	100%	49	0	21	21	24.4	29.5	25.3 J	21.1 J
Potassium	MG/KG	2520	100%	2380	1	21	21	1590	1610	1350 J	1310
Selenium	MG/KG	1.5	24%	2	0	5	21	0.86 U	0.82 U	0.12 U	0.52 U
Silver	MG/KG	0.25	5%	0.75	0	1	21	0.24 U	0.23 U	0.09 U	0.1 UJ
Sodium	MG/KG	1150	81%	172	6	17	21	92.5 U	355	116 J	169 J
Thallium	MG/KG	0	0%	0.7	0	0	21	1.3 U	1.2 U	0.21 U	0.37 U
Vanadium	MG/KG	26.3	100%	150	0	21	21	26.3	21.5	18.7 J	15.2 J
Zinc	MG/KG	133	100%	110	2	21	21	83.6 J	72.6 J	72.3 J	52.5 J

Note(s):

- (1) - Historical sample depths are presented (I.e. prior to 2002 TCRA)
- (2) - NYSDEC Technical and Administrative Guidance Memorandum (TAGM) HWR-94-4046, Revised January 24, 1994
- (3) - Sample/Duplicate pair are presented as individual samples in this table. Statistical information used Sample Duplicate pairs as a single entity and averaged result values were used in risk assessment analysis.

U = compound was not detected

J = the reported value is an estimated concentration

UJ = the compound was not detected; the associated reporting limit is approximate

R = the data was rejected in the data validating process

NJ = compound was "tentatively identified" and the associated numerical value is approximate

Table A-2B
SUBSURFACE SOIL SAMPLE RESULTS (2-15 ft.)
SEAD-59
SEAD-59 and SEAD-71 Phase II RI Report
Seneca Army Depot Activity

Facility	SEAD-59	SEAD-59
Location ID	TP59-6-2	TP59-8-2
Maxtrix	SOIL	SOIL
Sample ID	59002	59050
Sample Depth to Top of Sample ⁽¹⁾	6	1.5
Sample Depth to Bottom of Sample ⁽¹⁾	6.5	2
Sample Date	10/7/1997	10/13/1997
QC Code	SA	SA
Study ID	RI PHASE 1 STEP 1	RI PHASE 1 STEP 1

Parameter	Units	Maximum Value	Frequency of Detection	NYSDEC TAGM 4046 ⁽²⁾	Number of Exceedances	Number of Detects	Number of Analyses ⁽³⁾	Value (Q)	Value (Q)
Volatile Organics									
1,1,1-Trichloroethane	UG/KG	0	0%	800	0	0	21	13 U	12 U
1,1,2,2-Tetrachloroethane	UG/KG	0	0%	600	0	0	21	13 U	12 U
1,1,2-Trichloro-1,2,2-Trifluoroethane	UG/KG	0	0%		0	0	0		
1,1,2-Trichloroethane	UG/KG	0	0%		0	0	21	13 U	12 U
1,1-Dichloroethane	UG/KG	0	0%	200	0	0	21	13 U	12 U
1,1-Dichloroethene	UG/KG	0	0%	400	0	0	21	13 U	12 U
1,2,3-Trichloropropane	UG/KG	0	0%		0	0	0		
1,2,4-Trichlorobenzene	UG/KG	0	0%	3400	0	0	0		
1,2-Dibromo-3-chloropropane	UG/KG	0	0%		0	0	0		
1,2-Dibromoethane	UG/KG	0	0%		0	0	0		
1,2-Dichlorobenzene	UG/KG	0	0%	7900	0	0	0		
1,2-Dichloroethane	UG/KG	0	0%	100	0	0	21	13 U	12 U
1,2-Dichloroethene (total)	UG/KG	0	0%		0	0	21	13 U	12 U
1,2-Dichloropropane	UG/KG	0	0%		0	0	21	13 U	12 U
1,3-Dichlorobenzene	UG/KG	0	0%	1600	0	0	0		
1,3-Dichloropropane	UG/KG	0	0%		0	0	0		
1,4-Dichlorobenzene	UG/KG	0	0%	8500	0	0	0		
Acetone	UG/KG	30	5%	200	0	1	21	13 U	12 U
Benzene	UG/KG	8.5	5%	60	0	1	21	13 U	12 U
Bromodichloromethane	UG/KG	0	0%		0	0	21	13 U	12 U
Bromoform	UG/KG	0	0%		0	0	21	13 U	12 U
Carbon disulfide	UG/KG	0	0%	2700	0	0	21	13 U	12 U
Carbon tetrachloride	UG/KG	0	0%	600	0	0	21	13 U	12 U
Chlorobenzene	UG/KG	0	0%	1700	0	0	21	13 U	12 U
Chlorodibromomethane	UG/KG	0	0%		0	0	21	13 U	12 U
Chloroethane	UG/KG	0	0%	1900	0	0	21	13 U	12 U
Chloroform	UG/KG	0	0%	300	0	0	21	13 U	12 U
Cis-1,2-Dichloroethene	UG/KG	0	0%		0	0	0		
Cis-1,3-Dichloropropene	UG/KG	0	0%		0	0	21	13 U	12 U
Cyclohexane	UG/KG	0	0%		0	0	0		
Dichlorodifluoromethane	UG/KG	0	0%		0	0	0		
Ethyl benzene	UG/KG	110	10%	5500	0	2	21	13 U	12 U
Isopropylbenzene	UG/KG	0	10%		0	0	0		
Meta/Para Xylene	UG/KG	0	10%		0	0	0		
Methyl Acetate	UG/KG	0	10%		0	0	0		
Methyl Tertbutyl Ether	UG/KG	0	10%		0	0	0		
Methyl bromide	UG/KG	0	0%		0	0	21	13 U	12 U
Methyl butyl ketone	UG/KG	0	0%		0	0	21	13 U	12 U
Methyl chloride	UG/KG	3	5%		0	1	21	13 U	12 U
Methyl cyclohexane	UG/KG	0	5%		0	0	0		
Methyl ethyl ketone	UG/KG	36	14%	300	0	3	21	36 J	12 U
Methyl isobutyl ketone	UG/KG	0	0%	1000	0	0	21	13 U	12 U

Table A-2B
SUBSURFACE SOIL SAMPLE RESULTS (2-15 ft.)
SEAD-59
SEAD-59 and SEAD-71 Phase II RI Report
Seneca Army Depot Activity

Facility	SEAD-59	SEAD-59
Location ID	TP59-6-2	TP59-8-2
Maxtrix	SOIL	SOIL
Sample ID	59002	59050
Sample Depth to Top of Sample ⁽¹⁾	6	1.5
Sample Depth to Bottom of Sample ⁽¹⁾	6.5	2
Sample Date	10/7/1997	10/13/1997
QC Code	SA	SA
Study ID	RI PHASE 1 STEP 1	RI PHASE 1 STEP 1

Parameter	Units	Maximum Value	Frequency of Detection	NYSDEC TAGM 4046 ⁽²⁾	Number of Exceedances	Number of Detects	Number of Analyses ⁽³⁾	Value (Q)	Value (Q)
Methylene chloride	UG/KG	1	5%	100	0	1	21	13 U	12 U
Ortho Xylene	UG/KG	0	5%		0	0	0		
Styrene	UG/KG	0	0%		0	0	21	13 U	12 U
Tetrachloroethene	UG/KG	0	0%	1400	0	0	21	13 U	12 U
Toluene	UG/KG	13.5	14%	1500	0	3	21	13 U	12 U
Total BTEX	MG/KG	9.5	93%		0	14	15	8	3.5
Total Xylenes	UG/KG	75.5	5%	1200	0	1	21	13 U	12 U
Trans-1,2-Dichloroethene	UG/KG	0	5%	300	0	0	0		
Trans-1,3-Dichloropropene	UG/KG	0	0%		0	0	21	13 U	12 U
Trichloroethene	UG/KG	0	0%	700	0	0	21	13 U	12 U
Trichlorofluoromethane	UG/KG	0	0%		0	0	0		
Vinyl chloride	UG/KG	0	0%	200	0	0	21	13 U	12 U
Semivolatile Organics									
1,1'-Biphenyl	UG/KG	0	0%		0	0	0		
1,2,4-Trichlorobenzene	UG/KG	0	0%	3400	0	0	21	89 U	150 U
1,2-Dichlorobenzene	UG/KG	0	0%	7900	0	0	21	89 U	150 U
1,3-Dichlorobenzene	UG/KG	0	0%	1600	0	0	21	89 U	150 U
1,4-Dichlorobenzene	UG/KG	0	0%	8500	0	0	21	89 U	150 U
2,2'-oxybis(1-Chloropropane)	UG/KG	0	0%		0	0	5		
2,4,5-Trichlorophenol	UG/KG	0	0%	100	0	0	21	220 U	360 U
2,4,6-Trichlorophenol	UG/KG	0	0%		0	0	21	89 U	150 U
2,4-Dichlorophenol	UG/KG	0	0%	400	0	0	21	89 U	150 U
2,4-Dimethylphenol	UG/KG	0	0%		0	0	21	89 U	150 U
2,4-Dinitrophenol	UG/KG	0	0%	200	0	0	21	220 U	360 U
2,4-Dinitrotoluene	UG/KG	0	0%		0	0	21	89 U	150 U
2,6-Dinitrotoluene	UG/KG	0	0%	1000	0	0	21	89 U	150 U
2-Chloronaphthalene	UG/KG	0	0%		0	0	21	89 U	150 U
2-Chlorophenol	UG/KG	0	0%	800	0	0	21	89 U	150 U
2-Methylnaphthalene	UG/KG	10000	57%	36400	0	12	21	17 J	14 J
2-Methylphenol	UG/KG	0	0%	100	0	0	21	89 U	150 U
2-Nitroaniline	UG/KG	0	0%	430	0	0	21	220 U	360 U
2-Nitrophenol	UG/KG	0	0%	330	0	0	21	89 U	150 U
3,3'-Dichlorobenzidine	UG/KG	0	0%		0	0	21	89 UJ	150 U
3-Nitroaniline	UG/KG	0	0%	500	0	0	21	220 UJ	360 U
4,6-Dinitro-2-methylphenol	UG/KG	0	0%		0	0	21	220 U	360 U
4-Bromophenyl phenyl ether	UG/KG	0	0%		0	0	21	89 U	150 U
4-Chloro-3-methylphenol	UG/KG	0	0%	240	0	0	21	89 U	150 U
4-Chloroaniline	UG/KG	0	0%	220	0	0	21	89 U	150 U
4-Chlorophenyl phenyl ether	UG/KG	0	0%		0	0	21	89 U	150 U
4-Methylphenol	UG/KG	83	10%	900	0	2	21	83 J	150 U
4-Nitroaniline	UG/KG	0	0%		0	0	21	220 U	360 U
4-Nitrophenol	UG/KG	0	0%	100	0	0	21	220 U	360 U
Acenaphthene	UG/KG	1600	57%	50000	0	12	21	29 J	18 J

Table A-2B
SUBSURFACE SOIL SAMPLE RESULTS (2-15 ft.)
SEAD-59
SEAD-59 and SEAD-71 Phase II RI Report
Seneca Army Depot Activity

Facility	SEAD-59	SEAD-59
Location ID	TP59-6-2	TP59-8-2
Maxtrix	SOIL	SOIL
Sample ID	59002	59050
Sample Depth to Top of Sample ⁽¹⁾	6	1.5
Sample Depth to Bottom of Sample ⁽¹⁾	6.5	2
Sample Date	10/7/1997	10/13/1997
QC Code	SA	SA
Study ID	RI PHASE 1 STEP 1	RI PHASE 1 STEP 1

Parameter	Units	Maximum Value	Frequency of Detection	NYSDEC TAGM 4046 ⁽²⁾	Number of Exceedances	Number of Detects	Number of Analyses ⁽³⁾	Value (Q)	Value (Q)
Acenaphthylene	UG/KG	460	48%	41000	0	10	21	11 J	8 J
Acetophenone	UG/KG	0	48%		0	0	0		
Aniline	UG/KG	0	48%		0	0	0		
Anthracene	UG/KG	2100	48%	50000	0	10	21	61 J	43 J
Atrazine	UG/KG	0	48%		0	0	0		
Benzaldehyde	UG/KG	0	48%		0	0	0		
Benzo(a)anthracene	UG/KG	4200	67%	224	7	14	21	280	200
Benzo(a)pyrene	UG/KG	4600	67%	61	9	14	21	260	210
Benzo(b)fluoranthene	UG/KG	4400	76%	1100	3	16	21	220 J	230
Benzo(ghi)perylene	UG/KG	2400	62%	50000	0	13	21	180	140 J
Benzo(k)fluoranthene	UG/KG	4900	62%	1100	3	13	21	260	180
Benzoic Acid	UG/KG	0	62%	2700	0	0	0		
Bis(2-Chloroethoxy)methane	UG/KG	0	0%		0	0	21	89 U	150 U
Bis(2-Chloroethyl)ether	UG/KG	0	0%		0	0	21	89 U	150 U
Bis(2-Chloroisopropyl)ether	UG/KG	0	0%		0	0	16	89 U	150 U
Bis(2-Ethylhexyl)phthalate	UG/KG	260	71%	50000	0	15	21	13 J	19 J
Butylbenzylphthalate	UG/KG	1000	10%	50000	0	2	21	89 U	150 U
Caprolactam	UG/KG	0	10%		0	0	0		
Carbazole	UG/KG	1500	52%		0	11	21	82 J	56 J
Chrysene	UG/KG	4400	71%	400	5	15	21	310	220
Di-n-butylphthalate	UG/KG	29	43%	8100	0	9	21	8.2 J	12 J
Di-n-octylphthalate	UG/KG	11	10%	50000	0	2	21	89 U	150 U
Dibenz(a,h)anthracene	UG/KG	890	38%	14	7	8	21	74 J	52 J
Dibenzofuran	UG/KG	1400	48%	6200	0	10	21	14 J	13 J
Diethyl phthalate	UG/KG	12	38%	7100	0	8	21	89 U	150 U
Dimethylphthalate	UG/KG	0	0%	2000	0	0	21	89 U	150 U
Fluoranthene	UG/KG	10000	71%	50000	0	15	21	590	460
Fluorene	UG/KG	3000	52%	50000	0	11	21	27 J	18 J
Hexachlorobenzene	UG/KG	0	0%	410	0	0	21	89 U	150 U
Hexachlorobutadiene	UG/KG	0	0%		0	0	21	89 U	150 U
Hexachlorocyclopentadiene	UG/KG	0	0%		0	0	21	89 U	150 U
Hexachloroethane	UG/KG	0	0%		0	0	21	89 U	150 U
Indeno(1,2,3-cd)pyrene	UG/KG	2300	62%	3200	0	13	21	180	140 J
Isophorone	UG/KG	0	0%	4400	0	0	21	89 U	150 U
N-Nitrosodiphenylamine	UG/KG	0	0%		0	0	21	89 U	150 U
N-Nitrosodipropylamine	UG/KG	0	0%		0	0	21	89 U	150 U
Naphthalene	UG/KG	750	48%	13000	0	10	21	15 J	11 J
Nitrobenzene	UG/KG	0	0%	200	0	0	21	89 U	150 U
Pentachlorophenol	UG/KG	0	0%	1000	0	0	21	220 U	360 U
Phenanthrene	UG/KG	8300	81%	50000	0	17	21	370	200
Phenol	UG/KG	17	5%	30	0	1	21	17 J	150 U
Pyrene	UG/KG	12000	80%	50000	0	16	20	500	340
Pyridine	UG/KG	0	80%		0	0	0		

Table A-2B
SUBSURFACE SOIL SAMPLE RESULTS (2-15 ft.)
SEAD-59
SEAD-59 and SEAD-71 Phase II RI Report
Seneca Army Depot Activity

Facility	SEAD-59	SEAD-59
Location ID	TP59-6-2	TP59-8-2
Maxtrix	SOIL	SOIL
Sample ID	59002	59050
Sample Depth to Top of Sample ⁽¹⁾	6	1.5
Sample Depth to Bottom of Sample ⁽¹⁾	6.5	2
Sample Date	10/7/1997	10/13/1997
QC Code	SA	SA
Study ID	RI PHASE 1 STEP 1	RI PHASE 1 STEP 1

Parameter	Units	Maximum Value	Frequency of Detection	NYSDEC TAGM 4046 ⁽²⁾	Number of Exceedances	Number of Detects	Number of Analyses ⁽³⁾	Value (Q)	Value (Q)	
Total Unknown PAHs as SV	MG/KG	25	36%		0	5	14	0.6 U		
Pesticides/PCBs										
4,4'-DDD	UG/KG	70	29%	2900	0	6	21	70	3.7 U	
4,4'-DDE	UG/KG	48	48%	2100	0	10	21	48	10	
4,4'-DDT	UG/KG	59	33%	2100	0	7	21	59	10	
Aldrin	UG/KG	0	0%	41	0	0	21	2.3 U	1.9 U	
Alpha-BHC	UG/KG	9.9	10%	110	0	2	21	2.3 U	1.9 U	
Alpha-Chlordane	UG/KG	17	10%		0	2	21	2.3 U	1.9 U	
Beta-BHC	UG/KG	3.6	24%	200	0	5	21	2.3 U	1.9 U	
Delta-BHC	UG/KG	1.4	19%	300	0	4	21	2.3 U	1.9 U	
Dieldrin	UG/KG	1.8	5%	44	0	1	21	4.4 U	1.8 J	
Endosulfan I	UG/KG	4.1	5%	900	0	1	21	2.3 U	1.9 U	
Endosulfan II	UG/KG	7.1	5%	900	0	1	21	4.4 U	3.7 U	
Endosulfan sulfate	UG/KG	4.3	5%	1000	0	1	21	4.3 J	3.7 U	
Endrin	UG/KG	7.7	5%	100	0	1	21	4.4 U	3.7 U	
Endrin aldehyde	UG/KG	6.3	14%		0	3	21	4.4 U	3.7 U	
Endrin ketone	UG/KG	4.4	5%		0	1	21	4.4 U	3.7 U	
Gamma-BHC/Lindane	UG/KG	0	0%	60	0	0	21	2.3 U	1.9 U	
Gamma-Chlordane	UG/KG	18	10%	540	0	2	21	2.3 U	1.9 U	
Heptachlor	UG/KG	0	0%	100	0	0	21	2.3 U	1.9 U	
Heptachlor epoxide	UG/KG	5.7	14%	20	0	3	21	5.7 J	1.9 U	
Methoxychlor	UG/KG	0	0%		0	0	21	23 U	19 U	
Toxaphene	UG/KG	0	0%		0	0	21	230 U	190 U	
Aroclor-1016	UG/KG	0	0%		0	0	21	44 U	37 U	
Aroclor-1221	UG/KG	0	0%		0	0	21	90 U	75 U	
Aroclor-1232	UG/KG	0	0%		0	0	21	44 U	37 U	
Aroclor-1242	UG/KG	0	0%		0	0	20	44 U	37 U	
Aroclor-1248	UG/KG	0	0%		0	0	21	44 U	37 U	
Aroclor-1254	UG/KG	0	0%	10000	0	0	21	44 U	37 U	
Aroclor-1260	UG/KG	0	0%	10000	0	0	21	44 U	37 U	
Metals										
Aluminum	MG/KG	15200	100%	19300	0	21	21	12600 J	12500 J	
Antimony	MG/KG	0.47	14%	5.9	0	3	21	0.73 UJ	0.56 UJ	
Arsenic	MG/KG	6	100%	8.2	0	21	21	6	5.1	
Barium	MG/KG	192	100%	300	0	21	21	101	113	
Beryllium	MG/KG	0.52	100%	1.1	0	21	21	0.52	0.32	
Cadmium	MG/KG	0.61	24%	2.3	0	5	21	0.1 U	0.08 U	
Calcium	MG/KG	123000	100%	121000	1	21	21	28000	28200	
Chromium	MG/KG	20.7	100%	29.6	0	21	21	18.8	18.6	
Cobalt	MG/KG	14.2	100%	30	0	21	21	10.6	11.7	
Copper	MG/KG	36.1	100%	33	1	21	21	25.1	25.3	
Cyanide	MG/KG	0	0%	0.35	0	0	21	0.72 U	0.48 U	
Iron	MG/KG	28900	100%	36500	0	21	21	25600	23200	

Table A-2B
SUBSURFACE SOIL SAMPLE RESULTS (2-15 ft.)
SEAD-59
SEAD-59 and SEAD-71 Phase II RI Report
Seneca Army Depot Activity

Facility	SEAD-59	SEAD-59
Location ID	TP59-6-2	TP59-8-2
Maxtrix	SOIL	SOIL
Sample ID	59002	59050
Sample Depth to Top of Sample ⁽¹⁾	6	1.5
Sample Depth to Bottom of Sample ⁽¹⁾	6.5	2
Sample Date	10/7/1997	10/13/1997
QC Code	SA	SA
Study ID	RI PHASE 1 STEP 1	RI PHASE 1 STEP 1

Parameter	Units	Maximum Value	Frequency of Detection	NYSDEC TAGM 4046 ⁽²⁾	Number of Exceedances	Number of Detects	Number of Analyses ⁽³⁾	Value (Q)	Value (Q)
Lead	MG/KG	65.5	100%	24.8	7	21	21	65.5 J	53.7 J
Magnesium	MG/KG	34400	100%	21500	1	21	21	4600 J	5710 J
Manganese	MG/KG	1150	100%	1060	1	21	21	572 J	886 J
Mercury	MG/KG	0.32	50%	0.1	4	10	20	0.15	0.09
Nickel	MG/KG	35.5	100%	49	0	21	21	25.4	27.8
Potassium	MG/KG	2520	100%	2380	1	21	21	1490	1460
Selenium	MG/KG	1.5	24%	2	0	5	21	1 U	0.77
Silver	MG/KG	0.25	5%	0.75	0	1	21	0.28 U	0.21 U
Sodium	MG/KG	1150	81%	172	6	17	21	134	83.1 U
Thallium	MG/KG	0	0%	0.7	0	0	21	1.5 U	1.2 U
Vanadium	MG/KG	26.3	100%	150	0	21	21	21.5	20.9
Zinc	MG/KG	133	100%	110	2	21	21	114 J	105 J

Note(s):

- (1) - Historical sample depths are presented (I.e. prior to 2002 TCRA)
- (2) - NYSDEC Technical and Administrative Guidance Memorandum (TAGM) HWR-94-4046, Revised January 24, 1994
- (3) - Sample/Duplicate pair are presented as individual samples in this table. Statistical information used Sample Duplicate pairs as a single entity and averaged result values were used in risk assessment analysis.

U = compound was not detected

J = the reported value is an estimated concentration

UJ = the compound was not detected; the associated reporting limit is approximate

R = the data was rejected in the data validating process

NJ = compound was "tentatively identified" and the associated numerical value is approximate

**Table A-3
GROUNDWATER SAMPLE RESULTS
SEAD-59**

**SEAD-59 and SEAD-71 Phase II RI Report
Seneca Army Depot Activity**

Facility	SEAD-59		SEAD-59		SEAD-59		SEAD-59		SEAD-59		SEAD-59		SEAD-59	
Location ID	MW59-1		MW59-2		MW59-3		MW59-4		MW59-6		MW59-7		MW59-2	
Matrix	GROUNDWATER		GROUNDWATER		GROUNDWATER		GROUNDWATER		GROUNDWATER		GROUNDWATER		GROUNDWATER	
Sample ID	592000		592001		592002		592003		592004		592005		592006	
Sample Depth to Top of Sample	8.86		12.93		8.04		8.43		12.45		0		0	
Sample Depth to Bottom of Sample	8.86		12.93		8.04		8.43		12.45		0		0	
Sample Date	4/6/2004		4/6/2004		4/5/2004		4/6/2004		4/5/2004		8/31/2004		8/31/2004	
QC Code	SA		SA		SA		SA		SA		SA		SA	
Study ID	RI 2004		RI 2004		RI 2004		RI 2004		RI 2004		RI 2004		RI 2004	
	Criteria	Criteria	Value		Value		Value		Value		Value		Value	
	Type ¹	Level	(Q)	(Q)	(Q)	(Q)	(Q)	(Q)	(Q)	(Q)	(Q)	(Q)	(Q)	(Q)
Volatile Organic Compounds														
1,1,1,2-Tetrachloroethane	UG/L	GA	5	0.25 U	0.25 U	0.25 U	0.25 U	0.25 U	0.25 U	0.25 U	0.25 U	0.25 U	0.25 U	0.25 U
1,1,1-Trichloroethane	UG/L	GA	5	0.25 U	0.25 U	0.25 U	0.25 U	0.25 U	0.25 U	0.25 U	0.25 U	0.25 U	0.25 U	0.25 U
1,1,2,2-Tetrachloroethane	UG/L	GA	5	0.25 U	0.25 U	0.25 U	0.25 U	0.25 U	0.25 U	0.25 U	0.25 U	0.25 U	0.25 U	0.25 U
1,1,2-Trichloroethane	UG/L	GA	1	0.25 U	0.25 U	0.25 U	0.25 U	0.25 U	0.25 U	0.25 U	0.25 U	0.25 U	0.25 U	0.25 U
1,1-Dichloroethane	UG/L	GA	5	0.25 U	0.25 U	0.25 U	0.25 U	0.25 U	0.25 U	0.25 U	0.25 U	0.25 U	0.25 U	0.25 U
1,1-Dichloroethene	UG/L	GA	5	0.25 U	0.25 U	0.25 U	0.25 U	0.25 U	0.25 U	0.25 U	0.25 U	0.25 U	0.25 U	0.25 U
1,1-Dichloropropene	UG/L	GA	5	0.25 U	0.25 U	0.25 U	0.25 U	0.25 U	0.25 U	0.25 U	0.25 U	0.25 U	0.25 U	0.25 U
1,2,3-Trichlorobenzene	UG/L	GA	5	0.25 U	0.25 U	0.25 U	0.25 U	0.25 U	0.25 U	0.25 U	0.25 U	0.25 U	0.25 U	0.25 U
1,2,3-Trichloropropane	UG/L	GA	0.04	0.25 U	0.25 U	0.25 U	0.25 U	0.25 U	0.25 U	0.25 U	0.25 U	0.25 U	0.25 U	0.25 U
1,2,4-Trichlorobenzene	UG/L	GA	5	0.25 U	0.25 U	0.25 U	0.25 U	0.25 U	0.25 U	0.25 U	0.25 U	0.25 U	0.25 U	0.25 U
1,2,4-Trimethylbenzene	UG/L	GA	5	0.25 U	0.25 U	0.25 U	0.25 U	0.25 U	0.25 U	0.25 U	0.25 U	0.25 U	0.25 U	0.25 U
1,2-Dibromo-3-chloropropane	UG/L	GA	0.04	0.25 U	0.25 U	0.25 U	0.25 U	0.25 U	0.25 U	0.25 U	0.25 U	0.25 U	0.25 U	0.25 U
1,2-Dibromoethane	UG/L	GA	0.0006	0.25 U	0.25 U	0.25 U	0.25 U	0.25 U	0.25 U	0.25 U	0.25 U	0.25 U	0.25 U	0.25 U
1,2-Dichlorobenzene	UG/L	GA	3	0.25 U	0.25 U	0.25 U	0.25 U	0.25 U	0.25 U	0.25 U	0.25 U	0.25 U	0.25 U	0.25 U
1,2-Dichloroethane	UG/L	GA	0.6	0.25 U	0.25 U	0.25 U	0.25 U	0.25 U	0.25 U	0.25 U	0.25 U	0.25 U	0.25 U	0.25 U
1,2-Dichloroethene (total)	UG/L	GA	5	0.25 U	0.25 U	0.25 U	0.25 U	0.25 U	0.25 U	0.25 U	0.25 U	0.25 U	0.25 U	0.25 U
1,2-Dichloropropane	UG/L	GA	1	0.25 U	0.25 U	0.25 U	0.25 U	0.25 U	0.25 U	0.25 U	0.25 U	0.25 U	0.25 U	0.25 U
1,3,5-Trimethylbenzene	UG/L	GA	5	0.25 U	0.25 U	0.25 U	0.25 U	0.25 U	0.25 U	0.25 U	0.25 U	0.25 U	0.25 U	0.25 U
1,3-Dichlorobenzene	UG/L	GA	3	0.25 U	0.25 U	0.25 U	0.25 U	0.25 U	0.25 U	0.25 U	0.25 U	0.25 U	0.25 U	0.25 U
1,3-Dichloropropane	UG/L	GA	5	0.25 U	0.25 U	0.25 U	0.25 U	0.25 U	0.25 U	0.25 U	0.25 U	0.25 U	0.25 U	0.25 U
1,4-Dichlorobenzene	UG/L	GA	3	0.25 U	0.25 U	0.25 U	0.25 U	0.25 U	0.25 U	0.25 U	0.25 U	0.25 U	0.25 U	0.25 U
2,2-Dichloropropane	UG/L			0.25 U	0.25 U	0.25 U	0.25 U	0.25 U	0.25 U	0.25 U	0.25 U	0.25 U	0.25 U	0.25 U
2-Chlorotoluene	UG/L	GA	5	0.25 U	0.25 U	0.25 U	0.25 U	0.25 U	0.25 U	0.25 U	0.25 U	0.25 U	0.25 U	0.25 U
Acetone	UG/L													
Benzene	UG/L	GA	1	0.25 U	0.25 U	0.25 U	0.25 U	0.25 U	0.25 U	0.25 U	0.25 U	0.25 U	0.25 U	0.25 U
Bromobenzene	UG/L	GA	5	0.25 U	0.25 U	0.25 U	0.25 U	0.25 U	0.25 U	0.25 U	0.25 U	0.25 U	0.25 U	0.25 U
Bromochloromethane	UG/L	GA	5	0.25 U	0.25 U	0.25 U	0.25 U	0.25 U	0.25 U	0.25 U	0.25 U	0.25 U	0.25 U	0.25 U
Bromodichloromethane	UG/L	MCL	80	0.25 U	0.25 U	0.25 U	0.25 U	0.25 U	0.25 U	0.25 U	0.25 U	0.25 U	0.25 U	0.25 U
Bromoform	UG/L	MCL	80	0.25 U	0.25 U	0.25 U	0.25 U	0.25 U	0.25 U	0.25 U	0.25 U	0.25 U	0.25 U	0.25 U
Carbon disulfide	UG/L													
Carbon tetrachloride	UG/L	GA	5	0.25 U	0.25 U	0.25 U	0.25 U	0.25 U	0.25 U	0.25 U	0.25 U	0.25 U	0.25 U	0.25 U
Chlorobenzene	UG/L	GA	5	0.25 U	0.25 U	0.25 U	0.25 U	0.25 U	0.25 U	0.25 U	0.25 U	0.25 U	0.25 U	0.25 U
Chlorodibromomethane	UG/L	MCL	80	0.25 U	0.25 U	0.25 U	0.25 U	0.25 U	0.25 U	0.25 U	0.25 U	0.25 U	0.25 U	0.25 U
Chloroethane	UG/L	GA	5	0.25 U	0.25 U	0.25 U	0.25 U	0.25 U	0.25 U	0.25 U	0.25 U	0.25 U	0.25 U	0.25 U
Chloroform	UG/L	GA	7	0.25 U	0.25 U	0.25 U	0.25 U	0.25 U	0.25 U	0.25 U	0.25 U	0.25 U	0.25 U	0.25 U
Cis-1,2-Dichloroethene	UG/L	GA	5	0.25 U	0.25 U	0.25 U	0.25 U	0.25 U	0.25 U	0.25 U	0.25 U	0.25 U	0.25 U	0.25 U

Table A-3
GROUNDWATER SAMPLE RESULTS
SEAD-59
SEAD-59 and SEAD-71 Phase II RI Report
Seneca Army Depot Activity

Facility	SEAD-59	SEAD-59	SEAD-59	SEAD-59	SEAD-59	SEAD-59	SEAD-59								
Location ID	MW59-1	MW59-2	MW59-3	MW59-4	MW59-6	MW59-7	MW59-2								
Matrix	GROUNDWATER	GROUNDWATER	GROUNDWATER	GROUNDWATER	GROUNDWATER	GROUNDWATER	GROUNDWATER								
Sample ID	592000	592001	592002	592003	592004	592005	592006								
Sample Depth to Top of Sample	8.86	12.93	8.04	8.43	12.45	0	0								
Sample Depth to Bottom of Sample	8.86	12.93	8.04	8.43	12.45	0	0								
Sample Date	4/6/2004	4/6/2004	4/5/2004	4/6/2004	4/5/2004	8/31/2004	8/31/2004								
QC Code	SA	SA	SA	SA	SA	SA	SA								
Study ID	RI 2004	RI 2004	RI 2004	RI 2004	RI 2004	RI 2004	RI 2004								
	Criteria	Criteria													
	Units	Type ¹	Level	Value	(Q)	Value	(Q)	Value	(Q)	Value	(Q)	Value	(Q)	Value	(Q)
Cis-1,3-Dichloropropene	UG/L	GA	0.4	0.25	U	0.25	U	0.25	U	0.25	U	0.25	U	0.25	U
Dichlorodifluoromethane	UG/L	GA	5	0.25	U	0.25	U	0.25	U	0.25	U	0.25	U	0.25	U
Ethyl benzene	UG/L	GA	5	0.25	U	0.25	U	0.25	U	0.25	U	0.25	U	0.25	U
Hexachlorobutadiene	UG/L	GA	0.5	0.25	U	0.25	U	0.25	U	0.25	U	0.25	U	0.25	U
Isopropylbenzene	UG/L	GA	5	0.25	U	0.25	U	0.25	U	0.25	U	0.25	U	0.25	U
Meta/Para Xylene	UG/L			0.25	U	0.25	U	0.25	U	0.25	U	0.25	U	0.25	U
Methyl bromide	UG/L	GA	5	0.25	U	0.25	U	0.25	U	0.25	U	0.25	U	0.25	U
Methyl butyl ketone	UG/L														
Methyl chloride	UG/L	GA	5	0.25	U	0.25	U	0.25	U	0.25	U	0.25	U	0.25	U
Methyl ethyl ketone	UG/L														
Methyl isobutyl ketone	UG/L														
Methylene bromide	UG/L	GA	5	0.25	U	0.25	U	0.25	U	0.25	U	0.25	U	0.25	U
Methylene chloride	UG/L	GA	5	0.25	U	0.25	U	0.25	U	0.25	U	0.25	U	0.25	U
Naphthalene	UG/L			0.25	U	0.25	U	0.25	U	0.25	U	0.25	U	0.25	U
Ortho Xylene	UG/L	GA	5	0.25	U	0.25	U	0.25	U	0.25	U	0.25	U	0.25	U
Propylbenzene	UG/L	GA	5	0.25	U	0.25	U	0.25	U	0.25	U	0.25	U	0.25	U
Styrene	UG/L	GA	5	0.25	U	0.25	U	0.25	U	0.25	U	0.25	U	0.25	U
Tetrachloroethene	UG/L	GA	5	0.25	U	0.25	U	0.25	U	0.25	U	0.25	U	0.25	U
Toluene	UG/L	GA	5	0.25	U	0.25	U	0.27	J	0.25	U	0.25	U	0.25	U
Total Xylenes	UG/L	GA	5	0.25	U	0.25	U	0.25	U	0.25	U	0.25	U	0.25	U
Trans-1,2-Dichloroethene	UG/L	GA	5	0.25	U	0.25	U	0.25	U	0.25	U	0.25	U	0.25	U
Trans-1,3-Dichloropropene	UG/L	GA	0.4	0.25	U	0.25	U	0.25	U	0.25	U	0.25	U	0.25	U
Trichloroethene	UG/L	GA	5	0.25	U	0.25	U	0.25	U	0.25	U	0.25	U	0.25	U
Trichlorofluoromethane	UG/L	GA	5	0.25	U	0.25	U	0.25	U	0.25	U	0.25	U	0.25	U
Vinyl acetate	UG/L			0.5	U	0.5	U	0.5	U	0.5	U	0.5	U	0.5	U
Vinyl chloride	UG/L	GA	2	0.25	U	0.25	U	0.25	U	0.25	U	0.25	U	0.25	U
n-Butylbenzene	UG/L	GA	5	0.25	U	0.25	U	0.25	U	0.25	U	0.25	U	0.25	U
p-Chlorotoluene	UG/L	GA	5	0.25	U	0.25	U	0.25	U	0.25	U	0.25	U	0.25	U
p-Isopropyltoluene	UG/L	GA	5	0.25	U	0.25	U	0.25	U	0.25	U	0.25	U	0.25	U
sec-Butylbenzene	UG/L	GA	5	0.25	U	0.25	U	0.25	U	0.25	U	0.25	U	0.25	U
tert-Butylbenzene	UG/L	GA	5	0.25	U	0.25	U	0.25	U	0.25	U	0.25	U	0.25	U
Semivolatile Organic Compounds															
1,2,4-Trichlorobenzene	UG/L	GA	5	5	U	4.95	U	4.85	U	5	U	4.95	U	5	U
1,2-Dichlorobenzene	UG/L	GA	3	5	U	4.95	U	4.85	U	5	U	4.95	U	5	U
1,2-Diphenylhydrazine	UG/L	GA	0	5	U	4.95	U	4.85	U	5	U	4.95	U	5	U
1,3-Dichlorobenzene	UG/L	GA	3	5	U	4.95	U	4.85	U	5	U	4.95	U	5	U
1,4-Dichlorobenzene	UG/L	GA	3	5	U	4.95	U	4.85	U	5	U	4.95	U	5	U

Table A-3
GROUNDWATER SAMPLE RESULTS
SEAD-59
SEAD-59 and SEAD-71 Phase II RI Report
Seneca Army Depot Activity

Facility	SEAD-59		SEAD-59		SEAD-59		SEAD-59		SEAD-59		SEAD-59		SEAD-59	
Location ID	MW59-1		MW59-2		MW59-3		MW59-4		MW59-6		MW59-7		MW59-2	
Matrix	GROUNDWATER		GROUNDWATER		GROUNDWATER		GROUNDWATER		GROUNDWATER		GROUNDWATER		GROUNDWATER	
Sample ID	592000		592001		592002		592003		592004		592005		592006	
Sample Depth to Top of Sample	8.86		12.93		8.04		8.43		12.45		0		0	
Sample Depth to Bottom of Sample	8.86		12.93		8.04		8.43		12.45		0		0	
Sample Date	4/6/2004		4/6/2004		4/5/2004		4/6/2004		4/5/2004		8/31/2004		8/31/2004	
QC Code	SA		SA		SA		SA		SA		SA		SA	
Study ID	RI 2004		RI 2004		RI 2004		RI 2004		RI 2004		RI 2004		RI 2004	
	Criteria	Criteria	Value		Value		Value		Value		Value		Value	
	Type ¹	Level	(Q)	(Q)	(Q)	(Q)	(Q)	(Q)	(Q)	(Q)	(Q)	(Q)	(Q)	(Q)
2,2'-oxybis(1-Chloropropane)	UG/L													
2,4,5-Trichlorophenol	UG/L	GA	1	5 U	4.95 U		4.85 U	5 U	4.95 U		5 UJ	5.4 U		
2,4,6-Trichlorophenol	UG/L	GA	1	5 U	4.95 U		4.85 U	5 U	4.95 U		5 UJ	5.4 U		
2,4-Dichlorophenol	UG/L	GA	5	5 U	4.95 U		4.85 U	5 U	4.95 U		5 UJ	5.4 U		
2,4-Dimethylphenol	UG/L			5 U	4.95 U		4.85 U	5 U	4.95 U		5 UJ	5.4 U		
2,4-Dinitrophenol	UG/L			10 U	9.9 U		9.7 U	10 U	9.9 U		10 UJ	10.75 U		
2,4-Dinitrotoluene	UG/L	GA	5	5 U	4.95 U		4.85 U	5 U	4.95 U		5 U	5.4 U		
2,6-Dichlorophenol	UG/L			5 U	4.95 U		4.85 U	5 U	4.95 U		5 UJ	5.4 U		
2,6-Dinitrotoluene	UG/L	GA	5	5 U	4.95 U		4.85 U	5 U	4.95 U		5 U	5.4 U		
2-Chloronaphthalene	UG/L			0.5 U	0.495 U		0.485 U	0.5 U	0.495 U		0.5 U	0.55 U		
2-Chlorophenol	UG/L			5 U	4.95 U		4.85 U	5 U	4.95 U		5 UJ	5.4 U		
2-Methylnaphthalene	UG/L			0.5 U	0.495 U		0.485 U	0.5 U	0.495 U		0.5 U	0.55 U		
2-Methylphenol	UG/L			5 U	4.95 U		4.85 U	5 U	4.95 U		5 UJ	5.4 U		
2-Nitroaniline	UG/L	GA	5	5 U	4.95 U		4.85 U	5 U	4.95 U		5 UJ	5.4 UJ		
2-Nitrophenol	UG/L	GA	1	5 U	4.95 U		4.85 U	5 U	4.95 U		5 UJ	5.4 U		
3,3'-Dichlorobenzidine	UG/L	GA	5	5 U	4.95 U		4.85 UJ	5 U	4.95 UJ		5 U	5.4 U		
3-Nitroaniline	UG/L	GA	5	5 U	4.95 U		4.85 U	5 U	4.95 U		5 UJ	5.4 UJ		
4,6-Dinitro-2-methylphenol	UG/L	GA	1	5 U	4.95 U		4.85 U	5 U	4.95 U		5 UJ	5.4 U		
4-Bromophenyl phenyl ether	UG/L			5 U	4.95 U		4.85 U	5 U	4.95 U		5 U	5.4 U		
4-Chloro-3-methylphenol	UG/L	GA	1	5 U	4.95 U		4.85 U	5 U	4.95 U		5 UJ	5.4 U		
4-Chloroaniline	UG/L	GA	5	5 U	4.95 U		4.85 U	5 U	4.95 U		5 U	5.4 U		
4-Chlorophenyl phenyl ether	UG/L			5 U	4.95 U		4.85 U	5 U	4.95 U		5 U	5.4 U		
4-Methylphenol	UG/L			5 U	4.95 U		4.85 U	5 U	4.95 U		5 UJ	5.4 U		
4-Nitroaniline	UG/L	GA	5	5 U	4.95 U		4.85 U	5 U	4.95 U		5 UJ	5.4 UJ		
4-Nitrophenol	UG/L	GA	1	5 U	4.95 U		4.85 U	5 U	4.95 U		5 UJ	5.4 U		
Acenaphthene	UG/L			0.5 U	0.495 U		0.485 U	0.5 U	0.495 U		0.5 U	0.55 U		
Acenaphthylene	UG/L			0.5 U	0.495 U		0.485 U	0.5 U	0.495 U		0.5 U	0.55 U		
Acetophenone	UG/L			5 U	4.95 U		4.85 U	5 U	4.95 U		5 U	5.4 U		
Anthracene	UG/L			0.5 U	0.495 U		0.485 U	0.5 U	0.495 U		0.5 U	0.55 U		
Benzidine	UG/L	GA	5	25 U	24.75 U		24.25 U	25 U	24.75 U		25 U	26.9 U		
Benzo(a)anthracene	UG/L			0.5 U	0.495 U		0.485 U	0.5 U	0.495 U		0.5 U	0.55 U		
Benzo(a)pyrene	UG/L	GA	0	0.5 U	0.495 U		0.485 U	0.5 U	0.495 U		0.5 U	0.55 U		
Benzo(b)fluoranthene	UG/L			0.5 U	0.495 U		0.485 U	0.5 U	0.495 U		0.5 U	0.55 U		
Benzo(ghi)perylene	UG/L			0.5 UJ	0.495 UJ		0.485 U	0.5 UJ	0.495 U		0.5 UJ	0.55 UJ		
Benzo(k)fluoranthene	UG/L			0.5 UJ	0.495 UJ		0.485 U	0.5 UJ	0.495 U		0.5 U	0.55 U		
Benzoic Acid	UG/L			10 UJ	9.9 UJ		9.7 U	10 UJ	9.9 U		10 U	10.75 U		
Benzyl alcohol	UG/L			5 U	4.95 U		4.85 U	5 U	4.95 U		5 U	5.4 U		

Table A-3
GROUNDWATER SAMPLE RESULTS
SEAD-59
SEAD-59 and SEAD-71 Phase II RI Report
Seneca Army Depot Activity

Facility	SEAD-59	SEAD-59	SEAD-59	SEAD-59	SEAD-59	SEAD-59	SEAD-59									
Location ID	MW59-1	MW59-2	MW59-3	MW59-4	MW59-6	MW59-7	MW59-2									
Matrix	GROUNDWATER	GROUNDWATER	GROUNDWATER	GROUNDWATER	GROUNDWATER	GROUNDWATER	GROUNDWATER									
Sample ID	592000	592001	592002	592003	592004	592005	592006									
Sample Depth to Top of Sample	8.86	12.93	8.04	8.43	12.45	0	0									
Sample Depth to Bottom of Sample	8.86	12.93	8.04	8.43	12.45	0	0									
Sample Date	4/6/2004	4/6/2004	4/5/2004	4/6/2004	4/5/2004	8/31/2004	8/31/2004									
QC Code	SA	SA	SA	SA	SA	SA	SA									
Study ID	RI 2004	RI 2004	RI 2004	RI 2004	RI 2004	RI 2004	RI 2004									
	Criteria	Criteria														
	Units	Type ¹	Level	Value	(Q)	Value	(Q)	Value	(Q)	Value	(Q)	Value	(Q)	Value	(Q)	
Bis(2-Chloroethoxy)methane	UG/L	GA	5	5 U		4.95 U		4.85 U		5 U		4.95 U		5 U		5.4 U
Bis(2-Chloroethyl)ether	UG/L	GA	1	5 U		4.95 U		4.85 U		5 U		4.95 U		5 U		5.4 U
Bis(2-Chloroisopropyl)ether	UG/L	GA	5	5 UJ		4.95 UJ		4.85 U		5 UJ		4.95 U		5 U		5.4 U
Bis(2-Ethylhexyl)phthalate	UG/L	GA	5	5 U		4.95 U		4.85 U		5 U		4.95 U		5 U		5.4 U
Butylbenzylphthalate	UG/L			5 U		4.95 U		4.85 U		5 U		4.95 U		5 U		5.4 U
Carbazole	UG/L			5 U		4.95 U		4.85 U		5 U		4.95 U		5 U		5.4 U
Chrysene	UG/L			0.5 U		0.495 U		0.485 U		0.5 U		0.495 U		0.5 U		0.55 U
Di-n-butylphthalate	UG/L	GA	50	5 U		4.95 U		4.85 U		5 U		4.95 U		2.3 J		5.4 U
Di-n-octylphthalate	UG/L			5 U		4.95 U		4.85 U		5 U		4.95 U		5 U		5.4 U
Dibenz(a,h)anthracene	UG/L			0.5 U		0.495 U		0.485 U		0.5 U		0.495 U		0.5 U		0.55 U
Dibenzofuran	UG/L			5 U		4.95 U		4.85 U		5 U		4.95 U		5 U		5.4 U
Diethyl phthalate	UG/L			5 U		4.95 U		4.85 U		5 U		4.95 U		5 U		5.4 U
Dimethylphthalate	UG/L			5 U		4.95 U		4.85 U		5 U		4.95 U		5 U		5.4 U
Diphenylamine	UG/L	GA	5	5 U		4.95 U		4.85 U		5 U		4.95 U		5 U		5.4 U
Fluoranthene	UG/L			0.5 U		0.495 U		0.485 U		0.5 U		0.495 U		0.5 U		0.55 U
Fluorene	UG/L			0.5 U		0.495 U		0.485 U		0.5 U		0.495 U		0.5 U		0.55 U
Hexachlorobenzene	UG/L	GA	0.04	5 U		4.95 U		4.85 U		5 U		4.95 U		5 U		5.4 U
Hexachlorobutadiene	UG/L	GA	0.5	5 U		4.95 U		4.85 U		5 U		4.95 U		5 U		5.4 U
Hexachlorocyclopentadiene	UG/L	GA	5													
Hexachloroethane	UG/L	GA	5	5 U		4.95 U		4.85 U		5 U		4.95 U		5 U		5.4 U
Indeno(1,2,3-cd)pyrene	UG/L			0.5 UJ		0.495 UJ		0.485 U		0.5 UJ		0.495 U		0.5 U		0.55 U
Isophorone	UG/L			5 U		4.95 U		4.85 U		5 U		4.95 U		5 U		5.4 U
N-Nitrosodimethylamine	UG/L			5 UJ		4.95 UJ		4.85 U		5 UJ		4.95 U		5 U		5.4 U
N-Nitrosodiphenylamine	UG/L															
N-Nitrosodipropylamine	UG/L			5 U		4.95 U		4.85 U		5 U		4.95 U		5 U		5.4 U
N-Nitrosopyrrolidine	UG/L			5 U		4.95 U		4.85 U		5 U		4.95 U		5 U		5.4 U
Naphthalene	UG/L			0.5 U		0.495 U		0.485 U		0.5 U		0.495 U		0.5 U		0.55 U
Nitrobenzene	UG/L	GA	0.4	5 U		4.95 U		4.85 U		5 U		4.95 U		5 U		5.4 U
Pentachlorophenol	UG/L	GA	1	5 U		4.95 U		4.85 U		5 U		4.95 U		5 UJ		5.4 U
Phenanthrene	UG/L			0.5 U		0.495 U		0.485 U		0.5 U		0.495 U		0.5 U		0.55 U
Phenol	UG/L	GA	1	5 U		4.95 U		4.85 U		5 U		4.95 U		5 UJ		5.4 U
Pyrene	UG/L			0.5 U		0.495 U		0.485 U		0.5 U		0.495 U		0.5 U		0.55 U
Pesticides/PCBs																
4,4'-DDD	UG/L	GA	0.3	0.0196 U		0.01885 U		0.0198 UJ		0.01925 U		0.01925 U		0.0194 U		0.0196 U
4,4'-DDE	UG/L	GA	0.2	0.008 J		0.01885 U		0.0198 UJ		0.01925 U		0.008 J		0.0194 U		0.0196 U
4,4'-DDT	UG/L	GA	0.2	0.0196 U		0.01885 U		0.042 J		0.01925 U		0.01925 UJ		0.0194 U		0.0196 U
Aldrin	UG/L	GA	0	0.0098 U		0.00945 U		0.0099 UJ		0.0096 U		0.0096 U		0.0097 U		0.0098 U

Table A-3
GROUNDWATER SAMPLE RESULTS
SEAD-59
SEAD-59 and SEAD-71 Phase II RI Report
Seneca Army Depot Activity

Facility	SEAD-59	SEAD-59	SEAD-59	SEAD-59	SEAD-59	SEAD-59	SEAD-59			
Location ID	MW59-1	MW59-2	MW59-3	MW59-4	MW59-6	MW59-7	MW59-2			
Maxtrix	GROUNDWATER	GROUNDWATER	GROUNDWATER	GROUNDWATER	GROUNDWATER	GROUNDWATER	GROUNDWATER			
Sample ID	592000	592001	592002	592003	592004	592005	592006			
Sample Depth to Top of Sample	8.86	12.93	8.04	8.43	12.45	0	0			
Sample Depth to Bottom of Sample	8.86	12.93	8.04	8.43	12.45	0	0			
Sample Date	4/6/2004	4/6/2004	4/5/2004	4/6/2004	4/5/2004	8/31/2004	8/31/2004			
QC Code	SA	SA	SA	SA	SA	SA	SA			
Study ID	RI 2004	RI 2004	RI 2004	RI 2004	RI 2004	RI 2004	RI 2004			
	Criteria	Criteria								
	Units	Type ¹	Level	Value (Q)	Value (Q)	Value (Q)	Value (Q)	Value (Q)		
Alpha-BHC	UG/L	GA	0.01	0.0098 U	0.00945 U	0.0099 UJ	0.0096 U	0.0096 U	0.0097 U	0.0098 U
Alpha-Chlordane	UG/L									
Beta-BHC	UG/L	GA	0.04	0.0098 U	0.00945 U	0.0099 UJ	0.0096 U	0.0096 U	0.0097 U	0.0098 U
Chlordane	UG/L			0.1225 U	0.118 U	0.124 UJ	0.12 U	0.12 U	0.1215 U	0.1225 U
Delta-BHC	UG/L	GA	0.04	0.0098 U	0.00945 U	0.0099 UJ	0.0096 U	0.0096 U	0.0097 U	0.0098 U
Dieldrin	UG/L	GA	0.004	0.0196 U	0.01885 U	0.0198 UJ	0.01925 U	0.01925 U	0.0194 U	0.0196 U
Endosulfan I	UG/L			0.0098 U	0.00945 U	0.0099 UJ	0.0096 U	0.0096 U	0.0097 U	0.0098 U
Endosulfan II	UG/L			0.0196 U	0.01885 U	0.0198 UJ	0.01925 U	0.01925 U	0.0194 U	0.0196 U
Endosulfan sulfate	UG/L			0.0196 U	0.01885 U	0.0198 UJ	0.01925 U	0.01925 U	0.0194 U	0.0196 U
Endrin	UG/L	GA	0	0.0196 U	0.01885 U	0.0198 UJ	0.01925 U	0.01925 U	0.0194 U	0.0196 U
Endrin aldehyde	UG/L	GA	5	0.0196 U	0.01885 U	0.0198 UJ	0.01925 U	0.01925 U	0.0194 U	0.0196 U
Endrin ketone	UG/L	GA	5	0.0196 U	0.01885 U	0.0198 UJ	0.01925 U	0.01925 U	0.0194 U	0.0196 U
Gamma-BHC/Lindane	UG/L	GA	0.05	0.0098 U	0.00945 U	0.0099 UJ	0.0096 U	0.0096 U	0.0097 U	0.0098 U
Gamma-Chlordane	UG/L									
Heptachlor	UG/L	GA	0.04	0.0098 UJ	0.00945 UJ	0.0099 UJ	0.0096 UJ	0.0096 U	0.0097 U	0.0098 U
Heptachlor epoxide	UG/L	GA	0.03	0.0098 U	0.00945 U	0.0099 UJ	0.0096 U	0.0096 U	0.0097 U	0.0098 U
Methoxychlor	UG/L	GA	35	0.098 U	0.0945 U	0.099 UJ	0.096 U	0.096 U	0.097 U	0.098 U
Toxaphene	UG/L	GA	0.06	0.49 U	0.4715 U	0.495 UJ	0.481 U	0.481 U	0.4855 U	0.49 U
Aroclor-1016	UG/L	GA	0.09	0.245 U	0.236 U	0.2475 UJ	0.2405 U	0.2405 U	0.2425 U	0.245 U
Aroclor-1221	UG/L	GA	0.09	0.245 U	0.236 U	0.2475 UJ	0.2405 U	0.2405 U	0.2425 U	0.245 U
Aroclor-1232	UG/L	GA	0.09	0.245 U	0.236 U	0.2475 UJ	0.2405 U	0.2405 U	0.2425 U	0.245 U
Aroclor-1242	UG/L	GA	0.09	0.245 U	0.236 U	0.2475 UJ	0.2405 U	0.2405 U	0.2425 U	0.245 U
Aroclor-1248	UG/L	GA	0.09	0.245 U	0.236 U	0.2475 UJ	0.2405 U	0.2405 U	0.2425 U	0.245 U
Aroclor-1254	UG/L	GA	0.09	0.245 U	0.236 U	0.2475 UJ	0.2405 U	0.2405 U	0.2425 U	0.245 U
Aroclor-1260	UG/L	GA	0.09	0.245 U	0.236 U	0.2475 UJ	0.2405 U	0.2405 U	0.2425 U	0.245 U
Metals and Cyanide										
Aluminum	UG/L	SEC	50	100	26.8 J	165	7.35 U	3250	50.8 J	73.8
Antimony	UG/L	GA	3	5.49 J	6.58 J	8.6 J	2.54 U	8.34 J	5 U	5 U
Arsenic	UG/L	MCL	10	2.235 U	1.12 U	11.2 U	1.12 U	1.12 U	2.5 U	2.5 U
Barium	UG/L	GA	1000	54.7	80.1	120	62.5	60.2	69.6	132
Beryllium	UG/L	MCL	4	0.079 U	0.079 U	0.079 U	0.079 U	0.079 U	2.5 U	2.5 U
Cadmium	UG/L	GA	5	0.518 J	0.1565 U	0.1565 U	0.335 J	0.404 J	2.5 U	2.5 U
Calcium	UG/L			125000	102000	169000	127000	158000	107000	131000
Chromium	UG/L	GA	50	0.2515 U	0.2515 U	0.2515 U	0.2515 U	3.54	0.53 J	0.72 J
Cobalt	UG/L			0.775 J	0.2705 U	0.2705 U	0.2705 U	2.92	2.5 U	1.2 J
Copper	UG/L	GA	200	0.695 U	0.695 U	2.04 J	1.42 J	4.65 J	2.5 U	2.5 U
Cyanide	UG/L									

Table A-3
GROUNDWATER SAMPLE RESULTS
SEAD-59
SEAD-59 and SEAD-71 Phase II RI Report
Seneca Army Depot Activity

Facility	SEAD-59		SEAD-59		SEAD-59		SEAD-59		SEAD-59		SEAD-59		SEAD-59		
Location ID	MW59-1		MW59-2		MW59-3		MW59-4		MW59-6		MW59-7		MW59-2		
Matrix	GROUNDWATER		GROUNDWATER		GROUNDWATER		GROUNDWATER		GROUNDWATER		GROUNDWATER		GROUNDWATER		
Sample ID	592000		592001		592002		592003		592004		592005		592006		
Sample Depth to Top of Sample	8.86		12.93		8.04		8.43		12.45		0		0		
Sample Depth to Bottom of Sample	8.86		12.93		8.04		8.43		12.45		0		0		
Sample Date	4/6/2004		4/6/2004		4/5/2004		4/6/2004		4/5/2004		8/31/2004		8/31/2004		
QC Code	SA		SA		SA		SA		SA		SA		SA		
Study ID	RI 2004		RI 2004		RI 2004		RI 2004		RI 2004		RI 2004		RI 2004		
	Units	Criteria	Criteria	Value		Value		Value		Value		Value		Value	
		Type ¹	Level	(Q)	(Q)	(Q)	(Q)	(Q)	(Q)	(Q)	(Q)	(Q)	(Q)	(Q)	
Iron	UG/L	GA	300	252	83.7	321	184	3680	242	60.9	J				
Lead	UG/L	MCL	15	0.86 U	0.86 U	0.86 U	0.86 U	0.86 U	4.4	J	1.7	J			
Magnesium	UG/L			22800	22000	20800	21100	27900	23700	28800					
Manganese	UG/L	SEC	50	221	9.11	21.7	91.4	314	135	33.7					
Mercury	UG/L	GA	0.7	0.0235 U	0.0235 U	0.0235 U	0.0235 U	0.0235 U	0.1	U	0.1	U			
Nickel	UG/L	GA	100	4.98	0.345 U	0.812 J	0.345 U	6.08	2.5	U	0.84	J			
Potassium	UG/L			1500 J	817 J	1790 J	1190 J	2400 J	2320	1120					
Selenium	UG/L	GA	10	1.405 U	1.405 U	1.405 U	1.405 U	1.405 U	2.5	U	5.2	R			
Silver	UG/L	GA	50	0.4175 U	0.4175 U	0.4175 U	0.4175 U	0.4175 U	2.5	U	2.5	U			
Sodium	UG/L	GA	20000	35400	22000	304000	53200	50100	235000	36300					
Thallium	UG/L	MCL	2	5 U	5 U	5 U	5 U	5 U	10	U	10	U			
Vanadium	UG/L			0.303 U	0.303 U	0.303 U	0.303 U	5.26	2.5	U	2.5	U			
Zinc	UG/L	SEC	5000	3.21 J	3.44 J	13.2	2.78 J	11.1	2	J	1.5	J			

Note(s):

- (1) - (GA) NY State Class GA Groundwater Standard (TOGS 1.1.1, June 1998)
- (SEC) US EPA Secondary Drinking Water Regulation, non-enforceable
- (MCL) US EPA Maximum Contaminant Limit
- (2) - Sample-Duplicate pairs are presented as a combined sample in this table.
- In addition, the 'QC Code' field is labeled 'SADU'

U = compound was not detected

J = the reported value is an estimated concentration

UJ = the compound was not detected; the associated reporting limit is approximate

R = the data was rejected in the data validating process

NJ = compound was tentatively identified and the associated value is approximate

Table A-3
GROUNDWATER SAMPLE RESULTS
SEAD-59
SEAD-59 and SEAD-71 Phase II RI Report
Seneca Army Depot Activity

Facility	SEAD-59	SEAD-59	SEAD-59	SEAD-59	SEAD-59	SEAD-59	
Location ID	MW59-3	MW59-8	MW59-6	MW59-1	MW59-2	MW59-3	
Maxtrix	GROUNDWATER	GROUNDWATER	GROUNDWATER	GROUNDWATER	GROUNDWATER	GROUNDWATER	
Sample ID	592007/592010	592008	592009	MW59-1	MW59-2	MW59-3	
Sample Depth to Top of Sample	0	0	0	4.1	4.7	3.7	
Sample Depth to Bottom of Sample	0	0	0	8.1	10.5	7.7	
Sample Date	8/30/2004	8/30/2004	8/30/2004	3/30/1994	7/21/1994	7/21/1994	
QC Code	SA / DU	SA	SA	SA	SA	SA	
Study ID	RI 2004	RI 2004	RI 2004	ESI	ESI	ESI	
	Criteria	Criteria					
	Units	Type ¹	Level	Value	(Q)	Value	(Q)
Volatile Organic Compounds							
1,1,1,2-Tetrachloroethane	UG/L	GA	5	0.25 U		0.25 U	0.25 U
1,1,1-Trichloroethane	UG/L	GA	5	0.45 J		0.25 U	0.25 U
1,1,2,2-Tetrachloroethane	UG/L	GA	5	0.25 U		0.25 U	0.25 U
1,1,2-Trichloroethane	UG/L	GA	1	0.25 U		0.25 U	0.25 U
1,1-Dichloroethane	UG/L	GA	5	0.25 U		0.25 U	0.25 U
1,1-Dichloroethene	UG/L	GA	5	0.25 U		0.25 U	0.25 U
1,1-Dichloropropene	UG/L	GA	5	0.25 U		0.25 U	0.25 U
1,2,3-Trichlorobenzene	UG/L	GA	5	0.25 U		0.25 U	0.25 U
1,2,3-Trichloropropane	UG/L	GA	0.04	0.25 U		0.25 U	0.25 U
1,2,4-Trichlorobenzene	UG/L	GA	5	0.25 U		0.25 U	0.25 U
1,2,4-Trimethylbenzene	UG/L	GA	5	0.25 U		0.25 U	0.25 U
1,2-Dibromo-3-chloropropane	UG/L	GA	0.04	0.25 U		0.25 U	0.25 U
1,2-Dibromoethane	UG/L	GA	0.0006	0.25 U		0.25 U	0.25 U
1,2-Dichlorobenzene	UG/L	GA	3	0.25 U		0.25 U	0.25 U
1,2-Dichloroethane	UG/L	GA	0.6	0.25 U		0.25 U	0.25 U
1,2-Dichloroethene (total)	UG/L	GA	5				
1,2-Dichloropropane	UG/L	GA	1	0.25 U		0.25 U	0.25 U
1,3,5-Trimethylbenzene	UG/L	GA	5	0.25 U		0.25 U	0.25 U
1,3-Dichlorobenzene	UG/L	GA	3	0.25 U		0.25 U	0.25 U
1,3-Dichloropropane	UG/L	GA	5	0.25 U		0.25 U	0.25 U
1,4-Dichlorobenzene	UG/L	GA	3	0.25 U		0.25 U	0.25 U
2,2-Dichloropropane	UG/L			0.25 U		0.25 U	0.25 U
2-Chlorotoluene	UG/L	GA	5	0.25 U		0.25 U	0.25 U
Acetone	UG/L						
Benzene	UG/L	GA	1	0.25 U		0.25 U	0.25 U
Bromobenzene	UG/L	GA	5	0.25 U		0.25 U	0.25 U
Bromochloromethane	UG/L	GA	5	0.25 U		0.25 U	0.25 U
Bromodichloromethane	UG/L	MCL	80	0.25 U		0.25 U	0.25 U
Bromoform	UG/L	MCL	80	0.25 U		0.25 U	0.25 U
Carbon disulfide	UG/L						
Carbon tetrachloride	UG/L	GA	5	0.25 U		0.25 U	0.25 U
Chlorobenzene	UG/L	GA	5	0.25 U		0.25 U	0.25 U
Chlorodibromomethane	UG/L	MCL	80	0.25 U		0.25 U	0.25 U
Chloroethane	UG/L	GA	5	0.25 U		0.25 U	0.25 U
Chloroform	UG/L	GA	7	0.25 U		0.25 U	0.25 U
Cis-1,2-Dichloroethene	UG/L	GA	5	0.25 U		0.25 U	0.25 U

Table A-3
GROUNDWATER SAMPLE RESULTS
SEAD-59
SEAD-59 and SEAD-71 Phase II RI Report
Seneca Army Depot Activity

Facility	SEAD-59	SEAD-59	SEAD-59	SEAD-59	SEAD-59	SEAD-59									
Location ID	MW59-3	MW59-8	MW59-6	MW59-1	MW59-2	MW59-3									
Maxtrix	GROUNDWATER	GROUNDWATER	GROUNDWATER	GROUNDWATER	GROUNDWATER	GROUNDWATER									
Sample ID	592007/592010	592008	592009	MW59-1	MW59-2	MW59-3									
Sample Depth to Top of Sample	0	0	0	4.1	4.7	3.7									
Sample Depth to Bottom of Sample	0	0	0	8.1	10.5	7.7									
Sample Date	8/30/2004	8/30/2004	8/30/2004	3/30/1994	7/21/1994	7/21/1994									
QC Code	SA / DU	SA	SA	SA	SA	SA									
Study ID	RI 2004	RI 2004	RI 2004	ESI	ESI	ESI									
	Criteria	Criteria													
	Units	Type ¹	Level	Value	(Q)	Value	(Q)	Value	(Q)	Value	(Q)	Value	(Q)		
Cis-1,3-Dichloropropene	UG/L	GA	0.4	0.25	U	0.25	U	0.25	U	5	U	5	UJ	5	U
Dichlorodifluoromethane	UG/L	GA	5	0.25	U	0.25	U	0.25	U						
Ethyl benzene	UG/L	GA	5	0.25	U	0.25	U	0.25	U	5	U	5	UJ	5	U
Hexachlorobutadiene	UG/L	GA	0.5	0.25	U	0.25	U	0.25	U						
Isopropylbenzene	UG/L	GA	5	0.25	U	0.25	U	0.25	U						
Meta/Para Xylene	UG/L			0.25	U	0.25	U	0.25	U						
Methyl bromide	UG/L	GA	5	0.25	U	0.25	U	0.25	U	5	U	5	UJ	5	U
Methyl butyl ketone	UG/L									5	U	5	UJ	5	U
Methyl chloride	UG/L	GA	5	0.25	U	0.25	U	0.25	U	5	U	5	UJ	5	U
Methyl ethyl ketone	UG/L									5	U	5	UJ	5	U
Methyl isobutyl ketone	UG/L									5	U	5	UJ	5	U
Methylene bromide	UG/L	GA	5	0.25	U	0.25	U	0.25	U						
Methylene chloride	UG/L	GA	5	0.25	U	0.25	U	0.25	U	5	U	5	UJ	5	U
Naphthalene	UG/L			0.25	U	0.25	U	0.25	U						
Ortho Xylene	UG/L	GA	5	0.25	U	0.25	U	0.25	U						
Propylbenzene	UG/L	GA	5	0.25	U	0.25	U	0.25	U						
Styrene	UG/L	GA	5	0.25	U	0.25	U	0.25	U	5	U	5	UJ	5	U
Tetrachloroethene	UG/L	GA	5	0.25	U	0.25	U	0.25	U	5	U	5	UJ	5	U
Toluene	UG/L	GA	5	0.25	U	0.25	U	0.25	U	5	U	5	UJ	5	U
Total Xylenes	UG/L	GA	5	0.25	U	0.25	U	0.25	U	5	U	5	UJ	5	U
Trans-1,2-Dichloroethene	UG/L	GA	5	0.25	U	0.25	U	0.25	U						
Trans-1,3-Dichloropropene	UG/L	GA	0.4	0.25	U	0.25	U	0.25	U	5	U	5	UJ	5	U
Trichloroethene	UG/L	GA	5	0.25	U	0.25	U	0.25	U	5	U	5	UJ	5	U
Trichlorofluoromethane	UG/L	GA	5	0.25	U	0.25	U	0.25	U						
Vinyl acetate	UG/L			0.5	U	0.5	U	0.5	U						
Vinyl chloride	UG/L	GA	2	0.25	U	0.25	U	0.25	U	5	U	5	UJ	5	U
n-Butylbenzene	UG/L	GA	5	0.25	U	0.25	U	0.25	U						
p-Chlorotoluene	UG/L	GA	5	0.25	U	0.25	U	0.25	U						
p-Isopropyltoluene	UG/L	GA	5	0.25	U	0.25	U	0.25	U						
sec-Butylbenzene	UG/L	GA	5	0.25	U	0.25	U	0.25	U						
tert-Butylbenzene	UG/L	GA	5	0.25	U	0.25	U	0.25	U						
Semivolatile Organic Compounds															
1,2,4-Trichlorobenzene	UG/L	GA	5	4.9	U	5.1	U	5.2	U	5	U	5	U	5.5	U
1,2-Dichlorobenzene	UG/L	GA	3	4.9	U	5.1	U	5.2	U	5	U	5	U	5.5	U
1,2-Diphenylhydrazine	UG/L	GA	0	4.9	UJ	5.1	UJ	5.2	UJ						
1,3-Dichlorobenzene	UG/L	GA	3	4.9	U	5.1	U	5.2	U	5	U	5	U	5.5	U
1,4-Dichlorobenzene	UG/L	GA	3	4.9	U	5.1	U	5.2	U	5	U	5	U	5.5	U

Table A-3
GROUNDWATER SAMPLE RESULTS
SEAD-59
SEAD-59 and SEAD-71 Phase II RI Report
Seneca Army Depot Activity

Facility	SEAD-59	SEAD-59	SEAD-59	SEAD-59	SEAD-59	SEAD-59							
Location ID	MW59-3	MW59-8	MW59-6	MW59-1	MW59-2	MW59-3							
Maxtrix	GROUNDWATER	GROUNDWATER	GROUNDWATER	GROUNDWATER	GROUNDWATER	GROUNDWATER							
Sample ID	592007/592010	592008	592009	MW59-1	MW59-2	MW59-3							
Sample Depth to Top of Sample	0	0	0	4.1	4.7	3.7							
Sample Depth to Bottom of Sample	0	0	0	8.1	10.5	7.7							
Sample Date	8/30/2004	8/30/2004	8/30/2004	3/30/1994	7/21/1994	7/21/1994							
QC Code	SA / DU	SA	SA	SA	SA	SA							
Study ID	RI 2004	RI 2004	RI 2004	ESI	ESI	ESI							
	Criteria	Criteria											
	Units	Type ¹	Level	Value	(Q)	Value	(Q)	Value	(Q)	Value	(Q)	Value	(Q)
2,2'-oxybis(1-Chloropropane)	UG/L							5 U		5 U		5.5 U	
2,4,5-Trichlorophenol	UG/L	GA	1	4.9 U		5.1 U		5.2 U		12.5 U		13 U	
2,4,6-Trichlorophenol	UG/L	GA	1	4.9 U		5.1 U		5.2 U		5 U		5 U	
2,4-Dichlorophenol	UG/L	GA	5	4.9 U		5.1 U		5.2 U		5 U		5 U	
2,4-Dimethylphenol	UG/L			4.9 U		5.1 U		5.2 U		5 U		5 U	
2,4-Dinitrophenol	UG/L			9.85 U		10.2 U		10.4 U		12.5 U		13 U	
2,4-Dinitrotoluene	UG/L	GA	5	4.9 U		5.1 U		5.2 U		5 U		5 U	
2,6-Dichlorophenol	UG/L			4.9 U		5.1 U		5.2 U					
2,6-Dinitrotoluene	UG/L	GA	5	4.9 U		5.1 U		5.2 U		5 U		5 U	
2-Chloronaphthalene	UG/L			0.493 U		0.5 U		0.5 U		5 U		5 U	
2-Chlorophenol	UG/L			4.9 U		5.1 U		5.2 U		5 U		5 U	
2-Methylnaphthalene	UG/L			0.493 U		0.5 U		0.5 U		5 U		5 U	
2-Methylphenol	UG/L			4.9 U		5.1 U		5.2 U		5 U		5 U	
2-Nitroaniline	UG/L	GA	5	4.9 U		5.1 U		5.2 U		12.5 U		13 U	
2-Nitrophenol	UG/L	GA	1	4.9 U		5.1 U		5.2 U		5 U		5 U	
3,3'-Dichlorobenzidine	UG/L	GA	5	4.9 U		5.1 U		5.2 U		5 U		5 U	
3-Nitroaniline	UG/L	GA	5	4.9 U		5.1 U		5.2 U		12.5 U		13 U	
4,6-Dinitro-2-methylphenol	UG/L	GA	1	4.9 U		5.1 U		5.2 U		12.5 U		13 U	
4-Bromophenyl phenyl ether	UG/L			4.9 U		5.1 U		5.2 U		5 U		5 U	
4-Chloro-3-methylphenol	UG/L	GA	1	4.9 U		5.1 U		5.2 U		5 U		5 U	
4-Chloroaniline	UG/L	GA	5	4.9 U		5.1 U		5.2 U		5 U		5 U	
4-Chlorophenyl phenyl ether	UG/L			4.9 U		5.1 U		5.2 U		5 U		5 U	
4-Methylphenol	UG/L			4.9 U		5.1 U		5.2 U		5 U		5 U	
4-Nitroaniline	UG/L	GA	5	4.9 U		5.1 U		5.2 U		12.5 U		13 U	
4-Nitrophenol	UG/L	GA	1	4.9 U		5.1 U		5.2 U		12.5 U		13 U	
Acenaphthene	UG/L			0.493 U		0.5 U		0.5 U		5 U		5 U	
Acenaphthylene	UG/L			0.493 U		0.5 U		0.5 U		5 U		5 U	
Acetophenone	UG/L			4.9 U		5.1 U		5.2 U					
Anthracene	UG/L			0.493 U		0.5 U		0.5 U		5 U		5 U	
Benzidine	UG/L	GA	5	24.6 U		25.5 U		26.05 U					
Benzo(a)anthracene	UG/L			0.493 U		0.5 U		0.5 U		5 U		5 U	
Benzo(a)pyrene	UG/L	GA	0	0.493 U		0.5 U		0.5 U		5 U		5 U	
Benzo(b)fluoranthene	UG/L			0.493 UJ		0.5 UJ		0.5 UJ		5 U		5 U	
Benzo(ghi)perylene	UG/L			0.493 U		0.5 U		0.5 U		5 U		5 U	
Benzo(k)fluoranthene	UG/L			0.493 U		0.5 U		0.5 U		5 U		5 U	
Benzoic Acid	UG/L			9.9 UJ		10.2 UJ		10.4 UJ					
Benzyl alcohol	UG/L			4.9 U		5.1 U		5.2 U					

Table A-3
GROUNDWATER SAMPLE RESULTS
SEAD-59
SEAD-59 and SEAD-71 Phase II RI Report
Seneca Army Depot Activity

Facility	SEAD-59	SEAD-59	SEAD-59	SEAD-59	SEAD-59	SEAD-59								
Location ID	MW59-3	MW59-8	MW59-6	MW59-1	MW59-2	MW59-3								
Maxtrix	GROUNDWATER	GROUNDWATER	GROUNDWATER	GROUNDWATER	GROUNDWATER	GROUNDWATER								
Sample ID	592007/592010	592008	592009	MW59-1	MW59-2	MW59-3								
Sample Depth to Top of Sample	0	0	0	4.1	4.7	3.7								
Sample Depth to Bottom of Sample	0	0	0	8.1	10.5	7.7								
Sample Date	8/30/2004	8/30/2004	8/30/2004	3/30/1994	7/21/1994	7/21/1994								
QC Code	SA / DU	SA	SA	SA	SA	SA								
Study ID	RI 2004	RI 2004	RI 2004	ESI	ESI	ESI								
	Criteria	Criteria												
	Units	Type ¹	Level	Value	(Q)	Value	(Q)	Value	(Q)	Value	(Q)	Value	(Q)	
Bis(2-Chloroethoxy)methane	UG/L	GA	5	4.9 U		5.1 U		5.2 U		5 U		5 U		5.5 U
Bis(2-Chloroethyl)ether	UG/L	GA	1	4.9 U		5.1 U		5.2 U		5 U		5 U		5.5 U
Bis(2-Chloroisopropyl)ether	UG/L	GA	5	4.9 UJ		5.1 UJ		5.2 UJ						
Bis(2-Ethylhexyl)phthalate	UG/L	GA	5	4.9 U		5.1 U		5.2 U		5 U		5 U		5.5 U
Butylbenzylphthalate	UG/L			4.9 U		5.1 U		5.2 U		5 U		5 U		5.5 U
Carbazole	UG/L			4.9 U		5.1 U		5.2 U		5 U		5 U		5.5 U
Chrysene	UG/L			0.493 U		0.5 U		0.5 U		5 U		5 U		5.5 U
Di-n-butylphthalate	UG/L	GA	50	4.9 U		5.1 U		5.2 U		5 U		5 U		5.5 U
Di-n-octylphthalate	UG/L			4.9 U		5.1 U		5.2 U		5 U		5 U		5.5 U
Dibenz(a,h)anthracene	UG/L			0.493 U		0.5 U		0.5 U		5 U		5 U		5.5 U
Dibenzofuran	UG/L			4.9 U		5.1 U		5.2 U		5 U		5 U		5.5 U
Diethyl phthalate	UG/L			4.9 U		5.1 U		5.2 U		5 U		5 U		5.5 U
Dimethylphthalate	UG/L			4.9 U		5.1 U		5.2 U		5 U		5 U		5.5 U
Diphenylamine	UG/L	GA	5	4.9 U		5.1 U		5.2 U						
Fluoranthene	UG/L			0.493 U		0.5 U		0.5 U		5 U		5 U		5.5 U
Fluorene	UG/L			0.493 U		0.5 U		0.5 U		5 U		5 U		5.5 U
Hexachlorobenzene	UG/L	GA	0.04	4.9 U		5.1 U		5.2 U		5 U		5 U		5.5 U
Hexachlorobutadiene	UG/L	GA	0.5	4.9 U		5.1 U		5.2 U		5 U		5 U		5.5 U
Hexachlorocyclopentadiene	UG/L	GA	5							5 U		5 U		5.5 U
Hexachloroethane	UG/L	GA	5	4.9 U		5.1 U		5.2 U		5 U		5 U		5.5 U
Indeno(1,2,3-cd)pyrene	UG/L			0.493 U		0.5 U		0.5 U		5 U		5 U		5.5 U
Isophorone	UG/L			4.9 U		5.1 U		5.2 U		5 U		5 U		5.5 U
N-Nitrosodimethylamine	UG/L			4.9 U		5.1 U		5.2 U						
N-Nitrosodiphenylamine	UG/L									5 U		5 U		5.5 U
N-Nitrosodipropylamine	UG/L			4.9 U		5.1 U		5.2 U		5 U		5 U		5.5 U
N-Nitrosopyrrolidine	UG/L			4.9 U		5.1 U		5.2 U						
Naphthalene	UG/L			0.493 U		0.5 U		0.5 U		5 U		5 U		5.5 U
Nitrobenzene	UG/L	GA	0.4	4.9 U		5.1 U		5.2 U		5 U		5 U		5.5 U
Pentachlorophenol	UG/L	GA	1	4.9 U		5.1 U		5.2 U		12.5 U		13 U		13 U
Phenanthrene	UG/L			0.493 U		0.5 U		0.5 U		5 U		5 U		5.5 U
Phenol	UG/L	GA	1	4.9 U		5.1 U		5.2 U		5 U		2J		1J
Pyrene	UG/L			0.493 U		0.5 U		0.5 U		5 U		5 U		5.5 U
Pesticides/PCBs														
4,4'-DDD	UG/L	GA	0.3	0.02 U		0.01925 U		0.0194 U		0.05 U		0.05 U		0.05 U
4,4'-DDE	UG/L	GA	0.2	0.02 U		0.01925 U		0.0194 U		0.05 U		0.05 U		0.05 U
4,4'-DDT	UG/L	GA	0.2	0.02 U		0.01925 U		0.0194 U		0.05 U		0.05 U		0.05 U
Aldrin	UG/L	GA	0	0.01 U		0.0096 U		0.0097 U		0.026 U		0.026 U		0.026 U

Table A-3
GROUNDWATER SAMPLE RESULTS
SEAD-59
SEAD-59 and SEAD-71 Phase II RI Report
Seneca Army Depot Activity

Facility	SEAD-59	SEAD-59	SEAD-59	SEAD-59	SEAD-59	SEAD-59							
Location ID	MW59-3	MW59-8	MW59-6	MW59-1	MW59-2	MW59-3							
Maxtrix	GROUNDWATER	GROUNDWATER	GROUNDWATER	GROUNDWATER	GROUNDWATER	GROUNDWATER							
Sample ID	592007/592010	592008	592009	MW59-1	MW59-2	MW59-3							
Sample Depth to Top of Sample	0	0	0	4.1	4.7	3.7							
Sample Depth to Bottom of Sample	0	0	0	8.1	10.5	7.7							
Sample Date	8/30/2004	8/30/2004	8/30/2004	3/30/1994	7/21/1994	7/21/1994							
QC Code	SA / DU	SA	SA	SA	SA	SA							
Study ID	RI 2004	RI 2004	RI 2004	ESI	ESI	ESI							
	Criteria	Criteria											
	Units	Type ¹	Level	Value	(Q)	Value	(Q)	Value	(Q)	Value	(Q)	Value	(Q)
Alpha-BHC	UG/L	GA	0.01	0.01	U	0.0096	U	0.0097	U	0.026	U	0.026	U
Alpha-Chlordane	UG/L									0.026	U	0.026	U
Beta-BHC	UG/L	GA	0.04	0.01	U	0.0096	U	0.0097	U	0.026	U	0.026	U
Chlordane	UG/L			0.12	UJ	0.12	UJ	0.1215	UJ				
Delta-BHC	UG/L	GA	0.04	0.01	UJ	0.0096	UJ	0.0097	UJ	0.026	U	0.026	U
Dieldrin	UG/L	GA	0.004	0.02	U	0.01925	U	0.0194	U	0.05	U	0.05	U
Endosulfan I	UG/L			0.01	U	0.0096	U	0.0097	U	0.026	U	0.026	U
Endosulfan II	UG/L			0.02	U	0.01925	U	0.0194	U	0.05	U	0.05	U
Endosulfan sulfate	UG/L			0.02	U	0.01925	U	0.0194	U	0.05	U	0.05	U
Endrin	UG/L	GA	0	0.02	U	0.01925	U	0.0194	U	0.05	U	0.05	U
Endrin aldehyde	UG/L	GA	5	0.02	U	0.01925	U	0.0194	U	0.05	U	0.05	U
Endrin ketone	UG/L	GA	5	0.02	U	0.01925	U	0.0194	U	0.05	U	0.05	U
Gamma-BHC/Lindane	UG/L	GA	0.05	0.01	U	0.0096	U	0.0097	U	0.026	U	0.026	U
Gamma-Chlordane	UG/L									0.026	U	0.026	U
Heptachlor	UG/L	GA	0.04	0.01	U	0.0096	U	0.0097	U	0.026	U	0.026	U
Heptachlor epoxide	UG/L	GA	0.03	0.01	U	0.0096	U	0.0097	U	0.026	U	0.026	U
Methoxychlor	UG/L	GA	35	0.10	U	0.096	U	0.097	U	0.26	U	0.26	U
Toxaphene	UG/L	GA	0.06	0.5	U	0.481	U	0.4855	U	2.6	U	2.6	U
Aroclor-1016	UG/L	GA	0.09	0.2	U	0.2405	U	0.2425	U	0.5	U	0.5	U
Aroclor-1221	UG/L	GA	0.09	0.2	U	0.2405	U	0.2425	U	1.05	U	1.05	U
Aroclor-1232	UG/L	GA	0.09	0.2	U	0.2405	U	0.2425	U	0.5	U	0.5	U
Aroclor-1242	UG/L	GA	0.09	0.2	U	0.2405	U	0.2425	U	0.5	U	0.5	U
Aroclor-1248	UG/L	GA	0.09	0.2	U	0.2405	U	0.2425	U	0.5	U	0.5	U
Aroclor-1254	UG/L	GA	0.09	0.2	U	0.2405	U	0.2425	U	0.5	U	0.5	U
Aroclor-1260	UG/L	GA	0.09	0.2	U	0.2405	U	0.2425	U	0.5	U	0.5	U
Metals and Cyanide													
Aluminum	UG/L	SEC	50	219.5	J	179	J	288	J	1940	J	299	J
Antimony	UG/L	GA	3	5	U	5	U	5	U	0.495	U	0.65	U
Arsenic	UG/L	MCL	10	2.5	U	2.5	U	2.5	U	2	J	1	U
Barium	UG/L	GA	1000	80.5	J	98.3	J	55.8	J	102	J	99.6	J
Beryllium	UG/L	MCL	4	2.5	U	2.5	U	2.5	U	0.03	U	0.05	U
Cadmium	UG/L	GA	5	0.9	J	2.5	U	2.5	U	0.05	U	0.1	U
Calcium	UG/L			102500	J	138000	J	146000	J	140000	J	125000	J
Chromium	UG/L	GA	50	1.85	J	1.4	J	2.5	U	3.4	J	0.78	J
Cobalt	UG/L			2.5	U	2.5	U	0.68	J	3.5	J	1.1	J
Copper	UG/L	GA	200	2.2	J	2.5	U	2.5	U	4.3	J	0.25	U
Cyanide	UG/L									2.5	U	2.5	UJ

Table A-3
GROUNDWATER SAMPLE RESULTS
SEAD-59
SEAD-59 and SEAD-71 Phase II RI Report
Seneca Army Depot Activity

	Facility	SEAD-59	SEAD-59	SEAD-59	SEAD-59	SEAD-59	SEAD-59								
	Location ID	MW59-3	MW59-8	MW59-6	MW59-1	MW59-2	MW59-3								
	Maxtrix	GROUNDWATER	GROUNDWATER	GROUNDWATER	GROUNDWATER	GROUNDWATER	GROUNDWATER								
	Sample ID	592007/592010	592008	592009	MW59-1	MW59-2	MW59-3								
	Sample Depth to Top of Sample	0	0	0	4.1	4.7	3.7								
	Sample Depth to Bottom of Sample	0	0	0	8.1	10.5	7.7								
	Sample Date	8/30/2004	8/30/2004	8/30/2004	3/30/1994	7/21/1994	7/21/1994								
	QC Code	SA / DU	SA	SA	SA	SA	SA								
	Study ID	RI 2004	RI 2004	RI 2004	ESI	ESI	ESI								
	Criteria	Criteria													
	Units	Type ¹	Level	Value	(Q)	Value	(Q)	Value	(Q)	Value	(Q)	Value	(Q)		
Iron	UG/L	GA	300	265.5		666		484		3120		731	J	3940	J
Lead	UG/L	MCL	15	2.5	U	2.4	J	2.5	J	2.4	J	0.45	U	1.5	J
Magnesium	UG/L			12800		21700		27100		29000		29200		21200	
Manganese	UG/L	SEC	50	33.6	J	294		191		780		109		253	
Mercury	UG/L	GA	0.7	0.1	U	0.1	U	0.1	U	0.015	U	0.05	J	0.06	J
Nickel	UG/L	GA	100	1.75	J	5.5		3.6		7.6	J	1.9	J	6.7	J
Potassium	UG/L			1670		1830		1470		2110	J	2640	J	4150	J
Selenium	UG/L	GA	10		R	4.2	J	2.5	R	0.85	U	1.35	U	1.35	U
Silver	UG/L	GA	50	2.5	U	2.5	U	2.5	U	0.35	U	0.25	U	0.25	U
Sodium	UG/L	GA	20000	234500		148000		49000		66000		32100		239000	
Thallium	UG/L	MCL	2	10	U	10	U	10	U	0.8	U	4	J	2.8	J
Vanadium	UG/L			1.695	J	2.5	U	2.5	U	3.4	J	1.1	J	4.7	J
Zinc	UG/L	SEC	5000	7.75		2	J	2.5	J	21.8		4	J	26.2	

Note(s):

- (1) - (GA) NY State Class GA Groundwater Standard (TOGS 1.1.1, June 1997)
- (SEC) US EPA Secondary Drinking Water Regulation, non-enforceable
- (MCL) US EPA Maximum Contaminant Limit
- (2) - Sample-Duplicate pairs are presented as a combined sample in this report. In addition, the 'QC Code' field is labeled 'SADU'

U = compound was not detected

J = the reported value is an estimated concentration

UJ = the compound was not detected; the associated reporting limit is applied

R = the data was rejected in the data validating process

NJ = compound was tentatively identified and the associated value is applied

Table A-4A
SURFACE SOIL SAMPLE RESULTS (0-2 ft.)
SEAD-71
SEAD-59 and SEAD-71 Phase II RI Report
Seneca Army Depot Activity

Facility	SEAD-71	SEAD-71	SEAD-71	SEAD-71	SEAD-71	SEAD-71
Location ID	CL-71-A-F01	CL-71-A-WE1	CL-71-A-WN1	CL-71-A-WS1	CL-71-A-WW1	CL-71-B-F01
Maxtrix	SOIL	SOIL	SOIL	SOIL	SOIL	SOIL
Sample ID	CL-71-A-F01	CL-71-A-WE1	CL-71-A-WN1	CL-71-A-WS1	CL-71-A-WW1	CL-71-B-F01
Sample Depth to Top of Sample ⁽¹⁾	0	0	0	0	0	0
Sample Depth to Bottom of Sample ⁽¹⁾	0	0	0	0	0	0
Sample Date	5/6/2004	5/6/2004	5/6/2004	5/6/2004	5/6/2004	5/6/2004
QC Code	SA	SA	SA	SA	SA	SA
Study ID	ENSR IRM	ENSR IRM	ENSR IRM	ENSR IRM	ENSR IRM	ENSR IRM
Sample Round	1	1	1	1	1	1

Parameter	Units	Maximum Frequency of		NYSDEC TAGM 4046 ⁽²⁾	Number of Exceedances	Number of Detects	Number of Analyses	Value (Q)	Value (Q)	Value (Q)	Value (Q)	Value (Q)	Value (Q)
		Value	Detection										
Volatile Organics													
1,1,1-Trichloroethane	UG/KG	3	3%	800	0	2	68	5 U	5 U	5 U	5 U	5 U	5 U
1,1,2,2-Tetrachloroethane	UG/KG	0	0%	600	0	0	64	5 UJ	5 U	5 U	5 UJ	5 UJ	5 UJ
1,1,2-Trichloro-1,2,2-Trifluoroethane	UG/KG	0	0%		0	0	44	5 UJ	5 UJ	5 U	5 UJ	5 UJ	5 UJ
1,1,2-Trichloroethane	UG/KG	0	0%		0	0	47	5 U	5 U	5 U	5 U	5 U	5 U
1,1-Dichloroethane	UG/KG	0	0%	200	0	0	68	5 U	5 U	5 U	5 U	5 U	5 U
1,1-Dichloroethene	UG/KG	0	0%	400	0	0	68	5 U	5 U	5 U	5 U	5 U	5 U
1,2,3-Trichloropropane	UG/KG	0	0%		0	0	21						
1,2,4-Trichlorobenzene	UG/KG	0	0%	3400	0	0	40	5 UJ	5 U	5 U	5 UJ	5 UJ	5 UJ
1,2-Dibromo-3-chloropropane	UG/KG	0	0%		0	0	19	5 UJ	5 U	5 U	5 UJ	5 UJ	5 UJ
1,2-Dibromoethane	UG/KG	0	0%		0	0	23	5 U	5 U	5 U	5 U	5 U	5 U
1,2-Dichlorobenzene	UG/KG	0	0%	7900	0	0	40	5 UJ	5 U	5 U	5 UJ	5 UJ	5 UJ
1,2-Dichloroethane	UG/KG	0	0%	100	0	0	68	5 U	5 U	5 U	5 U	5 U	5 U
1,2-Dichloroethene (total)	UG/KG	0	0%		0	0	24						
1,2-Dichloropropane	UG/KG	0	0%		0	0	47	5 U	5 U	5 U	5 U	5 U	5 U
1,3-Dichlorobenzene	UG/KG	0	0%	1600	0	0	40	5 UJ	5 U	5 U	5 UJ	5 UJ	5 UJ
1,3-Dichloropropane	UG/KG	0	0%		0	0	21						
1,4-Dichlorobenzene	UG/KG	0	0%	8500	0	0	40	5 UJ	5 U	5 U	5 UJ	5 UJ	5 UJ
Acetone	UG/KG	74	13%	200	0	9	68	5 U	5 U	5 U	5 U	5 U	5 U
Benzene	UG/KG	2	3%	60	0	2	68	5 U	5 U	5 U	5 U	5 U	5 U
Bromodichloromethane	UG/KG	0	0%		0	0	47	5 U	5 U	5 U	5 U	5 U	5 U
Bromoform	UG/KG	0	0%		0	0	47	5 U	5 U	5 U	5 U	5 U	5 U
Carbon disulfide	UG/KG	5	4%	2700	0	3	68	5 U	5 U	5 U	5 U	5 U	5 U
Carbon tetrachloride	UG/KG	0	0%	600	0	0	68	5 U	5 U	5 U	5 U	5 U	5 U
Chlorobenzene	UG/KG	0	0%	1700	0	0	68	5 U	5 U	5 U	5 U	5 U	5 U
Chlorodibromomethane	UG/KG	0	0%		0	0	68	5 U	5 U	5 U	5 U	5 U	5 U
Chloroethane	UG/KG	0	0%	1900	0	0	68	5 U	5 U	5 U	5 U	5 U	5 U
Chloroform	UG/KG	0	0%	300	0	0	68	5 U	5 U	5 U	5 U	5 U	5 U
Cis-1,2-Dichloroethene	UG/KG	0	0%		0	0	23	5 U	5 U	5 U	5 U	5 U	5 U
Cis-1,3-Dichloropropene	UG/KG	0	0%		0	0	47	5 U	5 U	5 U	5 U	5 U	5 U
Cyclohexane	UG/KG	4	9%		0	2	23	5 U	5 U	5 U	5 U	5 U	5 U
Dichlorodifluoromethane	UG/KG	0	0%		0	0	23	5 UJ	5 UJ	5 UJ	5 UJ	5 UJ	5 UJ
Ethyl benzene	UG/KG	4	3%	5500	0	2	68	5 U	5 U	5 U	5 U	5 U	5 U
Isopropylbenzene	UG/KG	0	0%		0	0	23	5 U	5 U	5 U	5 U	5 U	5 U
Meta/Para Xylene	UG/KG	0	0%		0	0	21						
Methyl Acetate	UG/KG	0	0%		0	0	23	5 U	5 U	5 U	5 U	5 U	5 U
Methyl Tertbutyl Ether	UG/KG	0	0%		0	0	23	5 U	5 U	5 U	5 U	5 U	5 U
Methyl bromide	UG/KG	0	0%		0	0	47	5 U	5 U	5 U	5 U	5 U	5 U

Table A-4A
SURFACE SOIL SAMPLE RESULTS (0-2 ft.)
SEAD-71
SEAD-59 and SEAD-71 Phase II RI Report
Seneca Army Depot Activity

Facility	SEAD-71	SEAD-71	SEAD-71	SEAD-71	SEAD-71	SEAD-71
Location ID	CL-71-A-F01	CL-71-A-WE1	CL-71-A-WN1	CL-71-A-WS1	CL-71-A-WW1	CL-71-B-F01
Maxtrix	SOIL	SOIL	SOIL	SOIL	SOIL	SOIL
Sample ID	CL-71-A-F01	CL-71-A-WE1	CL-71-A-WN1	CL-71-A-WS1	CL-71-A-WW1	CL-71-B-F01
Sample Depth to Top of Sample ⁽¹⁾	0	0	0	0	0	0
Sample Depth to Bottom of Sample ⁽¹⁾	0	0	0	0	0	0
Sample Date	5/6/2004	5/6/2004	5/6/2004	5/6/2004	5/6/2004	5/6/2004
QC Code	SA	SA	SA	SA	SA	SA
Study ID	ENSR IRM	ENSR IRM	ENSR IRM	ENSR IRM	ENSR IRM	ENSR IRM
Sample Round	1	1	1	1	1	1

Parameter	Units	Maximum Frequency of		NYSDEC TAGM 4046 ⁽²⁾	Number of Exceedances	Number of Detects	Number of Analyses	Value (Q)	Value (Q)	Value (Q)	Value (Q)	Value (Q)	Value (Q)
		Value	Detection										
Methyl butyl ketone	UG/KG	0	0%		0	0	47	5 U	5 U	5 U	5 U	5 U	5 U
Methyl chloride	UG/KG	0	0%		0	0	47	5 U	5 U	5 U	5 U	5 U	5 U
Methyl cyclohexane	UG/KG	6	13%		0	3	23	5 U	5 U	5 U	5 U	5 U	5 U
Methyl ethyl ketone	UG/KG	0	0%	300	0	0	68	5 U	5 U	5 U	5 U	5 U	5 U
Methyl isobutyl ketone	UG/KG	0	0%	1000	0	0	68	5 U	5 U	5 U	5 U	5 U	5 U
Methylene chloride	UG/KG	11	12%	100	0	8	68	5 U	5 U	6 U	5 U	5 U	5 U
Ortho Xylene	UG/KG	0	0%		0	0	21						
Styrene	UG/KG	1	2%		0	1	47	5 U	5 U	5 U	5 U	5 U	5 U
Tetrachloroethene	UG/KG	33	1%	1400	0	1	68	5 U	5 U	5 U	5 U	5 U	5 U
Toluene	UG/KG	16	16%	1500	0	11	68	5 U	5 U	5 U	5 U	5 U	5 U
Total BTEX	MG/KG	11.6	100%		0	1	1						
Total Xylenes	UG/KG	11	11%	1200	0	5	44	5 UJ	5 U	5 U	5 UJ	5 UJ	5 UJ
Trans-1,2-Dichloroethene	UG/KG	0	0%	300	0	0	44	5 U	5 U	5 U	5 U	5 U	5 U
Trans-1,3-Dichloropropene	UG/KG	0	0%		0	0	47	5 U	5 U	5 U	5 U	5 U	5 U
Trichloroethene	UG/KG	0	0%	700	0	0	68	5 U	5 U	5 U	5 U	5 U	5 U
Trichlorofluoromethane	UG/KG	1	4%		0	1	23	5 UJ	5 UJ	5 U	5 UJ	5 UJ	5 UJ
Vinyl chloride	UG/KG	0	0%	200	0	0	68	5 U	5 U	5 U	5 U	5 U	5 U
Semivolatile Organics													
1,1'-Biphenyl	UG/KG	0	0%		0	0	23	400 U	350 U	360 U	370 U	350 U	350 U
1,2,4-Trichlorobenzene	UG/KG	0	0%	3400	0	0	24						
1,2-Dichlorobenzene	UG/KG	0	0%	7900	0	0	24						
1,3-Dichlorobenzene	UG/KG	0	0%	1600	0	0	24						
1,4-Dichlorobenzene	UG/KG	0	0%	8500	0	0	24						
2,2'-oxybis(1-Chloropropane)	UG/KG	0	0%		0	0	27	400 U	350 U	360 U	370 U	350 U	350 U
2,4,5-Trichlorophenol	UG/KG	0	0%	100	0	0	69	1000 U	880 U	900 U	920 U	890 U	870 U
2,4,6-Trichlorophenol	UG/KG	0	0%		0	0	69	400 U	350 U	360 U	370 U	350 U	350 U
2,4-Dichlorophenol	UG/KG	0	0%	400	0	0	69	400 U	350 U	360 U	370 U	350 U	350 U
2,4-Dimethylphenol	UG/KG	0	0%		0	0	47	400 U	350 U	360 U	370 U	350 U	350 U
2,4-Dinitrophenol	UG/KG	0	0%	200	0	0	69	1000 UJ	880 U	900 U	920 UJ	890 UJ	870 UJ
2,4-Dinitrotoluene	UG/KG	880	1%		0	1	69	400 U	350 U	360 U	370 U	350 U	350 U
2,6-Dinitrotoluene	UG/KG	0	0%	1000	0	0	69	400 U	350 U	360 U	370 U	350 U	350 U
2-Chloronaphthalene	UG/KG	0	0%		0	0	47	400 U	350 U	360 U	370 U	350 U	350 U
2-Chlorophenol	UG/KG	0	0%	800	0	0	69	400 U	350 U	360 U	370 U	350 U	350 U
2-Methylnaphthalene	UG/KG	19000	22%	36400	0	15	69	400 U	350 U	360 U	370 U	350 U	350 U
2-Methylphenol	UG/KG	0	0%	100	0	0	69	400 U	350 U	360 U	370 U	350 U	350 U
2-Nitroaniline	UG/KG	0	0%	430	0	0	69	1000 U	880 U	900 U	920 U	890 U	870 U
2-Nitrophenol	UG/KG	0	0%	330	0	0	69	400 U	350 U	360 U	370 U	350 U	350 U
3,3'-Dichlorobenzidine	UG/KG	0	0%		0	0	69	400 U	350 U	360 U	370 U	350 U	350 U

Table A-4A
SURFACE SOIL SAMPLE RESULTS (0-2 ft.)
SEAD-71
SEAD-59 and SEAD-71 Phase II RI Report
Seneca Army Depot Activity

Facility	SEAD-71	SEAD-71	SEAD-71	SEAD-71	SEAD-71	SEAD-71
Location ID	CL-71-A-F01	CL-71-A-WE1	CL-71-A-WN1	CL-71-A-WS1	CL-71-A-WW1	CL-71-B-F01
Maxtrix	SOIL	SOIL	SOIL	SOIL	SOIL	SOIL
Sample ID	CL-71-A-F01	CL-71-A-WE1	CL-71-A-WN1	CL-71-A-WS1	CL-71-A-WW1	CL-71-B-F01
Sample Depth to Top of Sample ⁽¹⁾	0	0	0	0	0	0
Sample Depth to Bottom of Sample ⁽¹⁾	0	0	0	0	0	0
Sample Date	5/6/2004	5/6/2004	5/6/2004	5/6/2004	5/6/2004	5/6/2004
QC Code	SA	SA	SA	SA	SA	SA
Study ID	ENSR IRM	ENSR IRM	ENSR IRM	ENSR IRM	ENSR IRM	ENSR IRM
Sample Round	1	1	1	1	1	1

Parameter	Units	Maximum Frequency of		NYSDEC TAGM 4046 ⁽²⁾	Number of Exceedances	Number of Detects	Number of Analyses	Value (Q)	Value (Q)	Value (Q)	Value (Q)	Value (Q)	Value (Q)
		Value	Detection										
3-Nitroaniline	UG/KG	0	0%	500	0	0	69	1000 U	880 U	900 U	920 U	890 U	870 U
4,6-Dinitro-2-methylphenol	UG/KG	0	0%		0	0	47	1000 UJ	880 U	900 U	920 UJ	890 UJ	870 UJ
4-Bromophenyl phenyl ether	UG/KG	0	0%		0	0	47	400 U	350 U	360 U	370 U	350 U	350 U
4-Chloro-3-methylphenol	UG/KG	0	0%	240	0	0	69	400 U	350 U	360 U	370 U	350 U	350 U
4-Chloroaniline	UG/KG	0	0%	220	0	0	69	400 U	350 U	360 U	370 U	350 U	350 U
4-Chlorophenyl phenyl ether	UG/KG	0	0%		0	0	47	400 U	350 U	360 U	370 U	350 U	350 U
4-Methylphenol	UG/KG	0	0%	900	0	0	69	400 U	350 U	360 U	370 U	350 U	350 U
4-Nitroaniline	UG/KG	75	2%		0	1	47	1000 U	880 U	900 U	920 U	890 U	870 U
4-Nitrophenol	UG/KG	0	0%	100	0	0	69	1000 U	880 U	900 U	920 U	890 U	870 U
Acenaphthene	UG/KG	42000	42%	50000	0	29	69	400 U	350 U	360 U	370 U	350 U	350 U
Acenaphthylene	UG/KG	1800	28%	41000	0	19	69	400 U	350 U	360 U	370 U	350 U	350 U
Acetophenone	UG/KG	0	0%		0	0	23	400 U	350 U	360 U	370 U	350 U	350 U
Aniline	UG/KG	0	0%		0	0	22						
Anthracene	UG/KG	100000	59%	50000	3	41	69	400 U	350 U	360 U	370 U	350 U	350 U
Atrazine	UG/KG	0	0%		0	0	23	400 U	350 U	360 U	370 U	350 U	350 U
Benzaldehyde	UG/KG	0	0%		0	0	23	400 U	350 U	360 U	370 U	350 U	350 U
Benzo(a)anthracene	UG/KG	150000	77%	224	40	53	69	55 J	350 U	360 U	370 U	350 U	350 U
Benzo(a)pyrene	UG/KG	120000	77%	61	47	53	69	58 J	350 U	360 U	370 U	350 U	350 U
Benzo(b)fluoranthene	UG/KG	88000	78%	1100	23	54	69	85 J	350 U	360 U	69 NJ	55 NJ	64 NJ
Benzo(ghi)perylene	UG/KG	62000	70%	50000	1	48	69	400 U	350 U	360 U	370 U	350 U	350 U
Benzo(k)fluoranthene	UG/KG	130000	61%	1100	20	42	69	400 U	350 U	360 U	370 U	350 U	350 U
Benzoic Acid	UG/KG	0	0%	2700	0	0	22						
Bis(2-Chloroethoxy)methane	UG/KG	0	0%		0	0	47	400 U	350 U	360 U	370 U	350 U	350 U
Bis(2-Chloroethyl)ether	UG/KG	0	0%		0	0	47	400 U	350 U	360 U	370 U	350 U	350 U
Bis(2-Chloroisopropyl)ether	UG/KG	0	0%		0	0	20						
Bis(2-Ethylhexyl)phthalate	UG/KG	140	9%	50000	0	6	69	400 U	350 U	360 U	370 U	350 U	350 U
Butylbenzylphthalate	UG/KG	0	0%	50000	0	0	69	400 U	350 U	360 U	370 U	350 U	350 U
Caprolactam	UG/KG	0	0%		0	0	23	400 U	350 U	360 U	370 U	350 U	350 U
Carbazole	UG/KG	77000	57%		0	27	47	400 U	350 U	360 U	370 U	350 U	350 U
Chrysene	UG/KG	150000	81%	400	37	56	69	67 J	350 U	360 U	370 U	350 U	350 U
Di-n-butylphthalate	UG/KG	140	6%	8100	0	4	69	400 U	350 U	360 U	370 U	350 U	350 U
Di-n-octylphthalate	UG/KG	0	0%	50000	0	0	69	400 U	350 U	360 U	370 U	350 U	350 U
Dibenz(a,h)anthracene	UG/KG	25000	58%	14	40	40	69	400 U	350 U	360 U	370 U	350 U	350 U
Dibenzofuran	UG/KG	38000	39%	6200	4	27	69	400 U	350 U	360 U	370 U	350 U	350 U
Diethyl phthalate	UG/KG	0	0%	7100	0	0	69	400 U	350 U	360 U	370 U	350 U	350 U
Dimethylphthalate	UG/KG	0	0%	2000	0	0	69	400 U	350 U	360 U	370 U	350 U	350 U
Fluoranthene	UG/KG	440000	84%	50000	6	58	69	120 J	350 U	360 U	110 J	99 J	110 J
Fluorene	UG/KG	62000	41%	50000	1	28	69	400 U	350 U	360 U	370 U	350 U	350 U

Table A-4A
SURFACE SOIL SAMPLE RESULTS (0-2 ft.)
SEAD-71
SEAD-59 and SEAD-71 Phase II RI Report
Seneca Army Depot Activity

Facility	SEAD-71	SEAD-71	SEAD-71	SEAD-71	SEAD-71	SEAD-71
Location ID	CL-71-A-F01	CL-71-A-WE1	CL-71-A-WN1	CL-71-A-WS1	CL-71-A-WW1	CL-71-B-F01
Maxtrix	SOIL	SOIL	SOIL	SOIL	SOIL	SOIL
Sample ID	CL-71-A-F01	CL-71-A-WE1	CL-71-A-WN1	CL-71-A-WS1	CL-71-A-WW1	CL-71-B-F01
Sample Depth to Top of Sample ⁽¹⁾	0	0	0	0	0	0
Sample Depth to Bottom of Sample ⁽¹⁾	0	0	0	0	0	0
Sample Date	5/6/2004	5/6/2004	5/6/2004	5/6/2004	5/6/2004	5/6/2004
QC Code	SA	SA	SA	SA	SA	SA
Study ID	ENSR IRM	ENSR IRM	ENSR IRM	ENSR IRM	ENSR IRM	ENSR IRM
Sample Round	1	1	1	1	1	1

Parameter	Units	Maximum Frequency of		NYSDEC TAGM 4046 ⁽²⁾	Number of Exceedances	Number of Detects	Number of Analyses	Value (Q)	Value (Q)	Value (Q)	Value (Q)	Value (Q)	Value (Q)
		Value	Detection										
Hexachlorobenzene	UG/KG	0	0%	410	0	0	69	400 U	350 U	360 U	370 U	350 U	350 U
Hexachlorobutadiene	UG/KG	0	0%		0	0	69	400 U	350 U	360 U	370 U	350 U	350 U
Hexachlorocyclopentadiene	UG/KG	0	0%		0	0	47	400 U	350 U	360 U	370 U	350 U	350 U
Hexachloroethane	UG/KG	0	0%		0	0	69	400 U	350 U	360 U	370 U	350 U	350 U
Indeno(1,2,3-cd)pyrene	UG/KG	65000	70%	3200	11	48	69	400 U	350 U	360 U	370 U	350 U	350 U
Isophorone	UG/KG	0	0%	4400	0	0	69	400 U	350 U	360 U	370 U	350 U	350 U
N-Nitrosodiphenylamine	UG/KG	0	0%		0	0	47	400 U	350 U	360 U	370 U	350 U	350 U
N-Nitrosodipropylamine	UG/KG	0	0%		0	0	47	400 U	350 U	360 U	370 U	350 U	350 U
Naphthalene	UG/KG	46000	22%	13000	1	15	69	400 U	350 U	360 U	370 U	350 U	350 U
Nitrobenzene	UG/KG	0	0%	200	0	0	69	400 U	350 U	360 U	370 U	350 U	350 U
Pentachlorophenol	UG/KG	0	0%	1000	0	0	69	1000 U	880 U	900 U	920 U	890 U	870 U
Phenanthrene	UG/KG	290000	78%	50000	5	54	69	56 J	350 U	360 U	67 J	48 J	56 J
Phenol	UG/KG	4.5	1%	30	0	1	69	400 U	350 U	360 U	370 U	350 U	350 U
Pyrene	UG/KG	280000	81%	50000	6	56	69	110 J	350 U	360 U	110 J	84 J	98 J
Pyridine	UG/KG	0	0%		0	0	22						
Pesticides/PCBs													
4,4'-DDD	UG/KG	240	26%	2900	0	18	69	4 U	3.5 U	3.6 U	3.7 U	3.5 U	3.5 U
4,4'-DDE	UG/KG	810	42%	2100	0	29	69	4 U	3.5 U	3.6 U	3.7 U	3.5 U	3.5 U
4,4'-DDT	UG/KG	1300	51%	2100	0	35	69	4 U	3.5 U	3.6 U	3.7 U	3.5 U	3.5 U
Aldrin	UG/KG	0	0%	41	0	0	69	2 U	1.8 U	1.8 U	1.9 U	1.8 U	1.8 U
Alpha-BHC	UG/KG	18	7%	110	0	5	69	2 U	1.8 U	1.8 U	1.9 U	1.8 U	1.8 U
Alpha-Chlordane	UG/KG	2	1%		0	1	69	2 U	1.8 U	1.8 U	1.9 U	1.8 U	1.8 U
Beta-BHC	UG/KG	35	9%	200	0	6	69	2 U	1.8 U	1.8 U	1.9 U	1.8 U	1.8 U
Delta-BHC	UG/KG	0	0%	300	0	0	69	2 U	1.8 U	1.8 U	1.9 U	1.8 U	1.8 U
Dieldrin	UG/KG	3.4	3%	44	0	2	69	4 U	3.5 U	3.6 U	3.7 U	3.5 U	3.5 U
Endosulfan I	UG/KG	15	10%	900	0	7	69	2 U	1.8 U	1.8 U	1.9 U	1.8 U	1.8 U
Endosulfan II	UG/KG	52	4%	900	0	3	69	4 U	3.5 U	3.6 U	3.7 U	3.5 U	3.5 U
Endosulfan sulfate	UG/KG	110	16%	1000	0	11	69	4 U	3.5 U	3.6 U	3.7 U	3.5 U	3.5 U
Endrin	UG/KG	120	14%	100	1	10	69	4 U	3.5 U	3.6 U	3.7 U	3.5 U	3.5 U
Endrin aldehyde	UG/KG	120	23%		0	16	69	4 U	3.5 U	3.6 U	3.7 U	3.5 U	3.5 U
Endrin ketone	UG/KG	180	22%		0	15	69	4 U	3.5 U	3.6 U	3.7 U	3.5 U	3.5 U
Gamma-BHC/Lindane	UG/KG	0	0%	60	0	0	69	2 U	1.8 U	1.8 U	1.9 U	1.8 U	1.8 U
Gamma-Chlordane	UG/KG	48	6%	540	0	4	69	2 U	1.8 U	1.8 U	1.9 U	1.8 U	1.8 U
Heptachlor	UG/KG	0	0%	100	0	0	69	2 U	1.8 U	1.8 U	1.9 U	1.8 U	1.8 U
Heptachlor epoxide	UG/KG	180	17%	20	4	12	69	2 U	1.8 U	1.8 U	1.9 U	1.8 U	1.8 U
Methoxychlor	UG/KG	520	16%		0	11	69	20 U	18 U	18 U	19 U	18 U	18 U
Toxaphene	UG/KG	0	0%		0	0	69	200 U	180 U	180 U	190 U	180 U	180 U
Aroclor-1016	UG/KG	0	0%		0	0	69	40 U	35 U	36 U	38 U	36 U	35 U

Table A-4A
SURFACE SOIL SAMPLE RESULTS (0-2 ft.)
SEAD-71
SEAD-59 and SEAD-71 Phase II RI Report
Seneca Army Depot Activity

Facility	SEAD-71	SEAD-71	SEAD-71	SEAD-71	SEAD-71	SEAD-71
Location ID	CL-71-A-F01	CL-71-A-WE1	CL-71-A-WN1	CL-71-A-WS1	CL-71-A-WW1	CL-71-B-F01
Maxtrix	SOIL	SOIL	SOIL	SOIL	SOIL	SOIL
Sample ID	CL-71-A-F01	CL-71-A-WE1	CL-71-A-WN1	CL-71-A-WS1	CL-71-A-WW1	CL-71-B-F01
Sample Depth to Top of Sample ⁽¹⁾	0	0	0	0	0	0
Sample Depth to Bottom of Sample ⁽¹⁾	0	0	0	0	0	0
Sample Date	5/6/2004	5/6/2004	5/6/2004	5/6/2004	5/6/2004	5/6/2004
QC Code	SA	SA	SA	SA	SA	SA
Study ID	ENSR IRM	ENSR IRM	ENSR IRM	ENSR IRM	ENSR IRM	ENSR IRM
Sample Round	1	1	1	1	1	1

Parameter	Units	Maximum Frequency of		NYSDEC TAGM 4046 ⁽²⁾	Number of Exceedances	Number of Detects	Number of Analyses	Value (Q)	Value (Q)	Value (Q)	Value (Q)	Value (Q)	Value (Q)
		Value	Detection										
Aroclor-1221	UG/KG	0	0%		0	0	69	40 U	35 U	36 U	38 U	36 U	35 U
Aroclor-1232	UG/KG	0	0%		0	0	69	40 U	35 U	36 U	38 U	36 U	35 U
Aroclor-1242	UG/KG	0	0%		0	0	69	40 U	35 U	36 U	38 U	36 U	35 U
Aroclor-1248	UG/KG	0	0%		0	0	69	40 U	35 U	36 U	38 U	36 U	35 U
Aroclor-1254	UG/KG	0	0%	10000	0	0	69	40 U	35 U	36 U	38 U	36 U	35 U
Aroclor-1260	UG/KG	200	4%	10000	0	3	69	40 U	35 U	36 U	38 U	36 U	35 U
Metals													
Aluminum	MG/KG	18000	100%	19300	0	69	69	14600 J	6120 J	7660 J	13400 J	10800 J	7920 J
Antimony	MG/KG	19.3	49%	5.9	5	34	69	1.8 J	0.96 J	1.3 J	1.6 J	1.5 J	1 J
Arsenic	MG/KG	14.6	100%	8.2	5	69	69	4.6	4.3	4.9	5.2	6.2	5.2
Barium	MG/KG	179	100%	300	0	69	69	114 J	54.9 J	47 J	119 J	61.9 J	54.1 J
Beryllium	MG/KG	0.88	99%	1.1	0	68	69	0.82	0.31	0.42	0.76	0.56	0.39
Cadmium	MG/KG	12.1	67%	2.3	4	46	69	0.3 J	0.17 J	0.2 J	0.3 J	0.29 J	0.19 J
Calcium	MG/KG	295000	100%	121000	11	69	69	6940 J	79800 J	83200 J	10300 J	32200 J	55000 J
Chromium	MG/KG	60.3	100%	29.6	5	69	69	22.7 J	10 J	12.4 J	22.1 J	16.3 J	11.9 J
Cobalt	MG/KG	14.6	100%	30	0	69	69	11.4 J	6.1 J	6.4 J	8.8 J	8.4 J	8.5 J
Copper	MG/KG	134	100%	33	21	69	69	25.8 J	18.7 J	20.1 J	26.1 J	19.7 J	18.9 J
Cyanide	MG/KG	0	0%	0.35	0	0	24						
Iron	MG/KG	65100	100%	36500	2	69	69	25600	13200	15300	24900	20700	18300
Lead	MG/KG	3470	100%	24.8	33	69	69	17.4 J	7.4 J	12.7 J	19.1 J	13.5 J	11.9 J
Magnesium	MG/KG	59300	100%	21500	6	69	69	4890 J	15300 J	9380 J	5580 J	8350 J	9620 J
Manganese	MG/KG	1330	100%	1060	1	69	69	488 J	373 J	541 J	297 J	476 J	481 J
Mercury	MG/KG	2.7	80%	0.1	10	55	69	0.07	0.02 J	0.02 J	0.05	0.04	0.03 J
Nickel	MG/KG	110	100%	49	2	69	69	35.4 J	18 J	20.5 J	32.6 J	24.1 J	21.2 J
Potassium	MG/KG	2180	100%	2380	0	69	69	1620	878	910	1260	965	863
Selenium	MG/KG	1.8	19%	2	0	13	69	0.45 U	0.41 U	0.43 U	0.42 U	0.43 U	0.39 U
Silver	MG/KG	2.2	39%	0.75	15	27	69	1.6	0.1 U	0.4 J	1.4	0.92	0.41 J
Sodium	MG/KG	1040	97%	172	19	67	69	79.7	143	145	60.4	94.6	112
Thallium	MG/KG	2.3	26%	0.7	10	18	69	0.22 U	0.2 U	0.22 U	0.21 U	0.21 U	0.2 U
Vanadium	MG/KG	29.2	100%	150	0	69	69	20.4 J	11.3 J	12.9 J	19.6 J	17.2 J	12.9 J
Zinc	MG/KG	3660	99%	110	17	68	69	88.7	45.3	57.6	81.9	69.8	56.8

Note(s):

- (1) - Historical sample depths are presented (I.e. prior to 2002 TCRA)
- (2) - NYSDEC Technical and Administrative Guidance Memorandum (TAGM) HWR-94-4046

U = compound was not detected
J = the reported value is an estimated concentration

Table A-4A
SURFACE SOIL SAMPLE RESULTS (0-2 ft.)
SEAD-71
SEAD-59 and SEAD-71 Phase II RI Report
Seneca Army Depot Activity

Facility	SEAD-71	SEAD-71	SEAD-71	SEAD-71	SEAD-71	SEAD-71
Location ID	CL-71-A-F01	CL-71-A-WE1	CL-71-A-WN1	CL-71-A-WS1	CL-71-A-WW1	CL-71-B-F01
Maxtrix	SOIL	SOIL	SOIL	SOIL	SOIL	SOIL
Sample ID	CL-71-A-F01	CL-71-A-WE1	CL-71-A-WN1	CL-71-A-WS1	CL-71-A-WW1	CL-71-B-F01
Sample Depth to Top of Sample ⁽¹⁾	0	0	0	0	0	0
Sample Depth to Bottom of Sample ⁽¹⁾	0	0	0	0	0	0
Sample Date	5/6/2004	5/6/2004	5/6/2004	5/6/2004	5/6/2004	5/6/2004
QC Code	SA	SA	SA	SA	SA	SA
Study ID	ENSR IRM	ENSR IRM	ENSR IRM	ENSR IRM	ENSR IRM	ENSR IRM
Sample Round	1	1	1	1	1	1

Parameter	Units	Maximum Value	Frequency of Detection	NYSDEC TAGM 4046 ⁽²⁾	Number of Exceedances	Number of Detects	Number of Analyses	Value (Q)	Value (Q)	Value (Q)	Value (Q)	Value (Q)	Value (Q)

UJ = the compound was not detected; the associated reporting limit is approximate

R = the data was rejected in the data validating process

NJ = compound was "tentatively identified" and the associated numerical value is approximate

Table A-4A
SURFACE SOIL SAMPLE RESULTS (0-2 ft.)
SEAD-71
SEAD-59 and SEAD-71 Phase II RI Report
Seneca Army Depot Activity

Facility	SEAD-71	SEAD-71	SEAD-71	SEAD-71	SEAD-71	SEAD-71
Location ID	CL-71-B-WE2	CL-71-B-WN1	CL-71-B-WS1	CL-71-B-WW1	CL-71-B-WW2	CL-71-C-F01
Maxtrix	SOIL	SOIL	SOIL	SOIL	SOIL	SOIL
Sample ID	CL-71-B-WE2	CL-71-B-WN1	CL-71-B-WS1	CL-71-B-WW1	CL-71-B-WW2	CL-71-C-F01
Sample Depth to Top of Sample ⁽¹⁾	0	0	0	0	0	0
Sample Depth to Bottom of Sample ⁽¹⁾	0	0	0	0	0	0
Sample Date	5/6/2004	5/6/2004	5/6/2004	5/6/2004	5/6/2004	5/6/2004
QC Code	SA	SA	SA	SA	SA	SA
Study ID	ENSR IRM	ENSR IRM	ENSR IRM	ENSR IRM	ENSR IRM	ENSR IRM
Sample Round	1	1	1	1	1	1

Parameter	Units	Maximum Frequency of		NYSDEC TAGM 4046 ⁽²⁾	Number of Exceedances	Number of Detects	Number of Analyses	Value (Q)	Value (Q)	Value (Q)	Value (Q)	Value (Q)	Value (Q)
		Value	Detection										
Volatile Organics													
1,1,1-Trichloroethane	UG/KG	3	3%	800	0	2	68	6 U	2 NJ	6 U	5 U	6 U	5.5 U
1,1,2,2-Tetrachloroethane	UG/KG	0	0%	600	0	0	64	6 UJ	5 R	6 UJ	5 UJ	6 UJ	5.5 U
1,1,2-Trichloro-1,2,2-Trifluoroethane	UG/KG	0	0%		0	0	44	6 UJ	5 UJ	6 UJ	5 UJ	6 U	5.5 U
1,1,2-Trichloroethane	UG/KG	0	0%		0	0	47	6 U	5 UJ	6 U	5 U	6 U	
1,1-Dichloroethane	UG/KG	0	0%	200	0	0	68	6 U	5 UJ	6 U	5 U	6 U	5.5 U
1,1-Dichloroethene	UG/KG	0	0%	400	0	0	68	6 U	5 UJ	6 U	5 U	6 U	5.5 U
1,2,3-Trichloropropane	UG/KG	0	0%		0	0	21						5.5 U
1,2,4-Trichlorobenzene	UG/KG	0	0%	3400	0	0	40	6 UJ	5 R	6 UJ	5 UJ	6 UJ	5.5 U
1,2-Dibromo-3-chloropropane	UG/KG	0	0%		0	0	19	6 UJ	5 R	6 UJ	5 UJ	6 UJ	
1,2-Dibromoethane	UG/KG	0	0%		0	0	23	6 U	5 UJ	6 U	5 U	6 U	
1,2-Dichlorobenzene	UG/KG	0	0%	7900	0	0	40	6 UJ	5 R	6 UJ	5 UJ	6 UJ	5.5 U
1,2-Dichloroethane	UG/KG	0	0%	100	0	0	68	6 U	5 UJ	6 U	5 U	6 U	5.5 U
1,2-Dichloroethene (total)	UG/KG	0	0%		0	0	24						
1,2-Dichloropropane	UG/KG	0	0%		0	0	47	6 U	5 UJ	6 U	5 U	6 U	
1,3-Dichlorobenzene	UG/KG	0	0%	1600	0	0	40	6 UJ	5 R	6 UJ	5 UJ	6 UJ	5.5 U
1,3-Dichloropropane	UG/KG	0	0%		0	0	21						5.5 U
1,4-Dichlorobenzene	UG/KG	0	0%	8500	0	0	40	6 UJ	5 R	6 UJ	5 UJ	6 UJ	5.5 U
Acetone	UG/KG	74	13%	200	0	9	68	4 NJ	54 J	4 NJ	5 U	6 U	22 U
Benzene	UG/KG	2	3%	60	0	2	68	6 U	5 UJ	6 U	5 U	6 U	5.5 U
Bromodichloromethane	UG/KG	0	0%		0	0	47	6 U	5 UJ	6 U	5 U	6 U	
Bromoform	UG/KG	0	0%		0	0	47	6 U	5 UJ	6 U	5 U	6 U	
Carbon disulfide	UG/KG	5	4%	2700	0	3	68	6 U	5 J	6 U	5 U	6 U	5.5 U
Carbon tetrachloride	UG/KG	0	0%	600	0	0	68	6 U	5 UJ	6 U	5 U	6 U	5.5 U
Chlorobenzene	UG/KG	0	0%	1700	0	0	68	6 U	5 UJ	6 U	5 U	6 U	5.5 U
Chlorodibromomethane	UG/KG	0	0%		0	0	68	6 U	5 UJ	6 U	5 U	6 U	5.5 U
Chloroethane	UG/KG	0	0%	1900	0	0	68	6 U	5 UJ	6 U	5 U	6 U	11 U
Chloroform	UG/KG	0	0%	300	0	0	68	6 U	5 UJ	6 U	5 U	6 U	5.5 U
Cis-1,2-Dichloroethene	UG/KG	0	0%		0	0	23	6 U	5 UJ	6 U	5 U	6 U	
Cis-1,3-Dichloropropene	UG/KG	0	0%		0	0	47	6 U	5 UJ	6 U	5 U	6 U	
Cyclohexane	UG/KG	4	9%		0	2	23	6 U	5 UJ	6 U	5 U	6 U	
Dichlorodifluoromethane	UG/KG	0	0%		0	0	23	6 U	5 UJ	6 U	5 UJ	6 UJ	
Ethyl benzene	UG/KG	4	3%	5500	0	2	68	6 U	5 UJ	6 U	5 U	6 U	5.5 U
Isopropylbenzene	UG/KG	0	0%		0	0	23	6 U	5 UJ	6 U	5 U	6 U	
Meta/Para Xylene	UG/KG	0	0%		0	0	21						5.5 U
Methyl Acetate	UG/KG	0	0%		0	0	23	6 U	5 UJ	6 U	5 U	6 U	
Methyl Tertbutyl Ether	UG/KG	0	0%		0	0	23	6 U	5 UJ	6 U	5 U	6 U	
Methyl bromide	UG/KG	0	0%		0	0	47	6 UJ	5 UJ	6 UJ	5 U	6 U	

Table A-4A
SURFACE SOIL SAMPLE RESULTS (0-2 ft.)
SEAD-71
SEAD-59 and SEAD-71 Phase II RI Report
Seneca Army Depot Activity

Facility	SEAD-71	SEAD-71	SEAD-71	SEAD-71	SEAD-71	SEAD-71
Location ID	CL-71-B-WE2	CL-71-B-WN1	CL-71-B-WS1	CL-71-B-WW1	CL-71-B-WW2	CL-71-C-F01
Maxtrix	SOIL	SOIL	SOIL	SOIL	SOIL	SOIL
Sample ID	CL-71-B-WE2	CL-71-B-WN1	CL-71-B-WS1	CL-71-B-WW1	CL-71-B-WW2	CL-71-C-F01
Sample Depth to Top of Sample ⁽¹⁾	0	0	0	0	0	0
Sample Depth to Bottom of Sample ⁽¹⁾	0	0	0	0	0	0
Sample Date	5/6/2004	5/6/2004	5/6/2004	5/6/2004	5/6/2004	5/6/2004
QC Code	SA	SA	SA	SA	SA	SA
Study ID	ENSR IRM	ENSR IRM	ENSR IRM	ENSR IRM	ENSR IRM	ENSR IRM
Sample Round	1	1	1	1	1	1

Parameter	Units	Maximum Frequency of		NYSDEC TAGM 4046 ⁽²⁾	Number of Exceedances	Number of Detects	Number of Analyses	Value (Q)	Value (Q)	Value (Q)	Value (Q)	Value (Q)	Value (Q)
		Value	Detection										
Methyl butyl ketone	UG/KG	0	0%		0	0	47	6 U	5 UJ	6 U	5 U	6 U	
Methyl chloride	UG/KG	0	0%		0	0	47	6 U	5 UJ	6 U	5 U	6 U	
Methyl cyclohexane	UG/KG	6	13%		0	3	23	6 U	3 J	6 U	5 U	6 U	
Methyl ethyl ketone	UG/KG	0	0%	300	0	0	68	6 U	5 UJ	6 U	5 U	6 U	11 U
Methyl isobutyl ketone	UG/KG	0	0%	1000	0	0	68	6 U	5 UJ	6 U	5 U	6 U	11 U
Methylene chloride	UG/KG	11	12%	100	0	8	68	6 U	7 U	6 U	9 U	11 U	5.5 U
Ortho Xylene	UG/KG	0	0%		0	0	21						5.5 U
Styrene	UG/KG	1	2%		0	1	47	6 U	5 UJ	6 U	5 U	6 U	
Tetrachloroethene	UG/KG	33	1%	1400	0	1	68	6 U	5 UJ	6 U	5 U	6 U	5.5 U
Toluene	UG/KG	16	16%	1500	0	11	68	6 U	1 J	6 U	5 U	6 U	5.5 U
Total BTEX	MG/KG	11.6	100%		0	1	1						
Total Xylenes	UG/KG	11	11%	1200	0	5	44	6 UJ	5 R	6 UJ	5 UJ	6 UJ	
Trans-1,2-Dichloroethene	UG/KG	0	0%	300	0	0	44	6 U	5 UJ	6 U	5 U	6 U	5.5 U
Trans-1,3-Dichloropropene	UG/KG	0	0%		0	0	47	6 U	5 UJ	6 U	5 U	6 U	
Trichloroethene	UG/KG	0	0%	700	0	0	68	6 U	5 UJ	6 U	5 U	6 U	5.5 U
Trichlorofluoromethane	UG/KG	1	4%		0	1	23	6 UJ	5 UJ	6 UJ	5 UJ	6 U	
Vinyl chloride	UG/KG	0	0%	200	0	0	68	6 U	5 UJ	6 U	5 U	6 U	11 U
Semivolatile Organics													
1,1'-Biphenyl	UG/KG	0	0%		0	0	23	400 U	1100 U	400 U	360 U	390 U	
1,2,4-Trichlorobenzene	UG/KG	0	0%	3400	0	0	24						
1,2-Dichlorobenzene	UG/KG	0	0%	7900	0	0	24						
1,3-Dichlorobenzene	UG/KG	0	0%	1600	0	0	24						
1,4-Dichlorobenzene	UG/KG	0	0%	8500	0	0	24						
2,2'-oxybis(1-Chloropropane)	UG/KG	0	0%		0	0	27	400 U	1100 U	400 U	360 U	390 U	
2,4,5-Trichlorophenol	UG/KG	0	0%	100	0	0	69	1000 U	2700 U	1000 U	920 U	990 U	360 U
2,4,6-Trichlorophenol	UG/KG	0	0%		0	0	69	400 U	1100 U	400 U	360 U	390 U	360 U
2,4-Dichlorophenol	UG/KG	0	0%	400	0	0	69	400 U	1100 U	400 U	360 U	390 U	360 U
2,4-Dimethylphenol	UG/KG	0	0%		0	0	47	400 U	1100 U	400 U	360 U	390 U	
2,4-Dinitrophenol	UG/KG	0	0%	200	0	0	69	1000 UJ	2700 UJ	1000 UJ	920 UJ	990 UJ	1900 U
2,4-Dinitrotoluene	UG/KG	880	1%		0	1	69	400 U	1100 U	400 U	360 U	390 U	360 U
2,6-Dinitrotoluene	UG/KG	0	0%	1000	0	0	69	400 U	1100 U	400 U	360 U	390 U	360 U
2-Chloronaphthalene	UG/KG	0	0%		0	0	47	400 U	1100 U	400 U	360 U	390 U	
2-Chlorophenol	UG/KG	0	0%	800	0	0	69	400 U	1100 U	400 U	360 U	390 U	360 U
2-Methylnaphthalene	UG/KG	19000	22%	36400	0	15	69	400 U	1100 U	400 U	360 U	390 U	61 J
2-Methylphenol	UG/KG	0	0%	100	0	0	69	400 U	1100 U	400 U	360 U	390 U	360 U
2-Nitroaniline	UG/KG	0	0%	430	0	0	69	1000 U	2700 U	1000 U	920 U	990 U	1900 U
2-Nitrophenol	UG/KG	0	0%	330	0	0	69	400 U	1100 U	400 U	360 U	390 U	360 U
3,3'-Dichlorobenzidine	UG/KG	0	0%		0	0	69	400 UJ	1100 U	400 U	360 U	390 U	360 U

Table A-4A
SURFACE SOIL SAMPLE RESULTS (0-2 ft.)
SEAD-71
SEAD-59 and SEAD-71 Phase II RI Report
Seneca Army Depot Activity

Facility	SEAD-71	SEAD-71	SEAD-71	SEAD-71	SEAD-71	SEAD-71
Location ID	CL-71-B-WE2	CL-71-B-WN1	CL-71-B-WS1	CL-71-B-WW1	CL-71-B-WW2	CL-71-C-F01
Maxtrix	SOIL	SOIL	SOIL	SOIL	SOIL	SOIL
Sample ID	CL-71-B-WE2	CL-71-B-WN1	CL-71-B-WS1	CL-71-B-WW1	CL-71-B-WW2	CL-71-C-F01
Sample Depth to Top of Sample ⁽¹⁾	0	0	0	0	0	0
Sample Depth to Bottom of Sample ⁽¹⁾	0	0	0	0	0	0
Sample Date	5/6/2004	5/6/2004	5/6/2004	5/6/2004	5/6/2004	5/6/2004
QC Code	SA	SA	SA	SA	SA	SA
Study ID	ENSR IRM	ENSR IRM	ENSR IRM	ENSR IRM	ENSR IRM	ENSR IRM
Sample Round	1	1	1	1	1	1

Parameter	Units	Maximum Frequency of		NYSDEC TAGM 4046 ⁽²⁾	Number of Exceedances	Number of Detects	Number of Analyses	Value (Q)	Value (Q)	Value (Q)	Value (Q)	Value (Q)	Value (Q)
		Value	Detection										
3-Nitroaniline	UG/KG	0	0%	500	0	0	69	1000 U	2700 U	1000 U	920 U	990 U	1900 U
4,6-Dinitro-2-methylphenol	UG/KG	0	0%		0	0	47	1000 U	2700 UJ	1000 U	920 U	990 U	
4-Bromophenyl phenyl ether	UG/KG	0	0%		0	0	47	400 U	1100 U	400 U	360 U	390 U	
4-Chloro-3-methylphenol	UG/KG	0	0%	240	0	0	69	400 U	1100 U	400 U	360 U	390 U	360 U
4-Chloroaniline	UG/KG	0	0%	220	0	0	69	400 UJ	1100 U	400 UJ	360 UJ	390 UJ	360 U
4-Chlorophenyl phenyl ether	UG/KG	0	0%		0	0	47	400 U	1100 U	400 U	360 U	390 U	
4-Methylphenol	UG/KG	0	0%	900	0	0	69	400 U	1100 U	400 U	360 U	390 U	360 U
4-Nitroaniline	UG/KG	75	2%		0	1	47	1000 U	2700 U	1000 U	920 U	990 U	
4-Nitrophenol	UG/KG	0	0%	100	0	0	69	1000 U	2700 U	1000 U	920 U	990 U	1900 U
Acenaphthene	UG/KG	42000	42%	50000	0	29	69	57 J	1100 U	400 U	360 U	390 U	300 J
Acenaphthylene	UG/KG	1800	28%	41000	0	19	69	120 J	190 J	400 U	360 U	390 U	360 U
Acetophenone	UG/KG	0	0%		0	0	23	400 U	1100 U	400 U	360 U	390 U	
Aniline	UG/KG	0	0%		0	0	22						360 U
Anthracene	UG/KG	100000	59%	50000	3	41	69	260 J	320 J	140 J	360 U	390 U	570
Atrazine	UG/KG	0	0%		0	0	23	400 U	1100 U	400 U	360 U	390 U	
Benzaldehyde	UG/KG	0	0%		0	0	23	400 U	1100 U	400 U	360 U	390 U	
Benzo(a)anthracene	UG/KG	150000	77%	224	40	53	69	1300 J	3100	470	360 U	390 U	1000
Benzo(a)pyrene	UG/KG	120000	77%	61	47	53	69	1400 J	2900	400	38 J	390 U	800
Benzo(b)fluoranthene	UG/KG	88000	78%	1100	23	54	69	1600 J	3600	690	54 NJ	390 U	570
Benzo(ghi)perylene	UG/KG	62000	70%	50000	1	48	69	810 J	1200	180 J	360 U	390 U	380
Benzo(k)fluoranthene	UG/KG	130000	61%	1100	20	42	69	1200 J	2100	270 J	360 U	390 U	670
Benzoic Acid	UG/KG	0	0%	2700	0	0	22						1900 U
Bis(2-Chloroethoxy)methane	UG/KG	0	0%		0	0	47	400 U	1100 U	400 U	360 U	390 U	
Bis(2-Chloroethyl)ether	UG/KG	0	0%		0	0	47	400 U	1100 U	400 U	360 U	390 U	
Bis(2-Chloroisopropyl)ether	UG/KG	0	0%		0	0	20						
Bis(2-Ethylhexyl)phthalate	UG/KG	140	9%	50000	0	6	69	400 UJ	1100 U	400 U	360 U	390 U	360 U
Butylbenzylphthalate	UG/KG	0	0%	50000	0	0	69	400 UJ	1100 U	400 U	360 U	390 U	360 U
Caprolactam	UG/KG	0	0%		0	0	23	400 U	1100 U	400 U	360 U	390 U	
Carbazole	UG/KG	77000	57%		0	27	47	120 J	1100 U	400 U	360 U	390 U	
Chrysene	UG/KG	150000	81%	400	37	56	69	1800 J	3000	620	47 J	390 U	880
Di-n-butylphthalate	UG/KG	140	6%	8100	0	4	69	400 U	1100 U	400 U	360 U	390 U	360 U
Di-n-octylphthalate	UG/KG	0	0%	50000	0	0	69	400 UJ	1100 U	400 U	360 U	390 U	360 U
Dibenz(a,h)anthracene	UG/KG	25000	58%	14	40	40	69	200 J	330 J	61 J	360 U	390 U	170 J
Dibenzofuran	UG/KG	38000	39%	6200	4	27	69	400 U	1100 U	400 U	360 U	390 U	140 J
Diethyl phthalate	UG/KG	0	0%	7100	0	0	69	400 U	1100 U	400 U	360 U	390 U	360 U
Dimethylphthalate	UG/KG	0	0%	2000	0	0	69	400 U	1100 U	400 U	360 U	390 U	360 U
Fluoranthene	UG/KG	440000	84%	50000	6	58	69	2200	4200	740	70 J	390 U	2000
Fluorene	UG/KG	62000	41%	50000	1	28	69	81 J	1100 U	400 U	360 U	390 U	250 J

Table A-4A
SURFACE SOIL SAMPLE RESULTS (0-2 ft.)
SEAD-71
SEAD-59 and SEAD-71 Phase II RI Report
Seneca Army Depot Activity

Facility	SEAD-71	SEAD-71	SEAD-71	SEAD-71	SEAD-71	SEAD-71
Location ID	CL-71-B-WE2	CL-71-B-WN1	CL-71-B-WS1	CL-71-B-WW1	CL-71-B-WW2	CL-71-C-F01
Maxtrix	SOIL	SOIL	SOIL	SOIL	SOIL	SOIL
Sample ID	CL-71-B-WE2	CL-71-B-WN1	CL-71-B-WS1	CL-71-B-WW1	CL-71-B-WW2	CL-71-C-F01
Sample Depth to Top of Sample ⁽¹⁾	0	0	0	0	0	0
Sample Depth to Bottom of Sample ⁽¹⁾	0	0	0	0	0	0
Sample Date	5/6/2004	5/6/2004	5/6/2004	5/6/2004	5/6/2004	5/6/2004
QC Code	SA	SA	SA	SA	SA	SA
Study ID	ENSR IRM	ENSR IRM	ENSR IRM	ENSR IRM	ENSR IRM	ENSR IRM
Sample Round	1	1	1	1	1	1

Parameter	Units	Maximum Frequency of		NYSDEC TAGM 4046 ⁽²⁾	Number of Exceedances	Number of Detects	Number of Analyses	Value (Q)	Value (Q)	Value (Q)	Value (Q)	Value (Q)	Value (Q)
		Value	Detection										
Hexachlorobenzene	UG/KG	0	0%	410	0	0	69	400 U	1100 U	400 U	360 U	390 U	360 U
Hexachlorobutadiene	UG/KG	0	0%		0	0	69	400 U	1100 U	400 U	360 U	390 U	360 U
Hexachlorocyclopentadiene	UG/KG	0	0%		0	0	47	400 U	1100 U	400 U	360 U	390 U	
Hexachloroethane	UG/KG	0	0%		0	0	69	400 U	1100 U	400 U	360 U	390 U	360 U
Indeno(1,2,3-cd)pyrene	UG/KG	65000	70%	3200	11	48	69	730 J	1200	190 J	360 U	390 U	420 J
Isophorone	UG/KG	0	0%	4400	0	0	69	400 U	1100 U	400 U	360 U	390 U	360 U
N-Nitrosodiphenylamine	UG/KG	0	0%		0	0	47	400 U	1100 U	400 U	360 U	390 U	
N-Nitrosodipropylamine	UG/KG	0	0%		0	0	47	400 U	1100 U	400 U	360 U	390 U	
Naphthalene	UG/KG	46000	22%	13000	1	15	69	400 U	1100 U	400 U	360 U	390 U	86 J
Nitrobenzene	UG/KG	0	0%	200	0	0	69	400 U	1100 U	400 U	360 U	390 U	360 U
Pentachlorophenol	UG/KG	0	0%	1000	0	0	69	1000 U	2700 U	1000 U	920 U	990 U	1900 U
Phenanthrene	UG/KG	290000	78%	50000	5	54	69	1200	810 J	320 J	360 U	390 U	1700
Phenol	UG/KG	4.5	1%	30	0	1	69	400 U	1100 U	400 U	360 U	390 U	360 U
Pyrene	UG/KG	280000	81%	50000	6	56	69	3000	5800	1000	78 J	390 U	1500
Pyridine	UG/KG	0	0%		0	0	22						1900 U
Pesticides/PCBs													
4,4'-DDD	UG/KG	240	26%	2900	0	18	69	17	3.6 U	40 U	3.6 U	3.9 U	22 U
4,4'-DDE	UG/KG	810	42%	2100	0	29	69	16 NJ	6.8 J	190	3.6 U	3.9 U	22 U
4,4'-DDT	UG/KG	1300	51%	2100	0	35	69	14 J	3.6 U	82	3.6 U	3.9 U	22 U
Aldrin	UG/KG	0	0%	41	0	0	69	2.1 U	1.8 U	21 U	1.9 U	2 U	11 U
Alpha-BHC	UG/KG	18	7%	110	0	5	69	2.1 U	1.8 U	21 U	1.9 UJ	2 UJ	11 U
Alpha-Chlordane	UG/KG	2	1%		0	1	69	2.1 U	1.8 U	21 U	1.9 U	2 U	11 U
Beta-BHC	UG/KG	35	9%	200	0	6	69	2.1 U	1.8 U	21 U	1.9 U	2 U	11 U
Delta-BHC	UG/KG	0	0%	300	0	0	69	2.1 U	1.8 U	21 U	1.9 U	2 U	11 U
Dieldrin	UG/KG	3.4	3%	44	0	2	69	4 U	3.6 U	40 U	3.6 U	3.9 U	22 U
Endosulfan I	UG/KG	15	10%	900	0	7	69	2.1 U	1.8 U	21 U	1.9 U	2 U	11 U
Endosulfan II	UG/KG	52	4%	900	0	3	69	4 U	3.6 U	40 U	3.6 U	3.9 U	22 U
Endosulfan sulfate	UG/KG	110	16%	1000	0	11	69	4 U	3.6 U	40 U	3.6 U	3.9 U	22 U
Endrin	UG/KG	120	14%	100	1	10	69	4 U	3.6 U	40 U	3.6 U	3.9 U	22 U
Endrin aldehyde	UG/KG	120	23%		0	16	69	4 U	3.6 U	40 U	3.6 U	3.9 U	22 U
Endrin ketone	UG/KG	180	22%		0	15	69	4 U	3.6 U	40 U	3.6 U	3.9 U	22 U
Gamma-BHC/Lindane	UG/KG	0	0%	60	0	0	69	2.1 U	1.8 U	21 U	1.9 U	2 U	11 U
Gamma-Chlordane	UG/KG	48	6%	540	0	4	69	2.1 U	1.8 U	21 U	1.9 U	2 U	11 U
Heptachlor	UG/KG	0	0%	100	0	0	69	2.1 U	1.8 U	21 U	1.9 U	2 U	11 U
Heptachlor epoxide	UG/KG	180	17%	20	4	12	69	2.1 U	1.8 U	21 U	1.9 U	2 U	11 U
Methoxychlor	UG/KG	520	16%		0	11	69	21 U	18 U	210 U	19 U	20 U	110 U
Toxaphene	UG/KG	0	0%		0	0	69	210 U	180 U	2100 U	190 U	200 U	220 U
Aroclor-1016	UG/KG	0	0%		0	0	69	41 U	36 U	41 U	37 U	40 U	36 U

Table A-4A
SURFACE SOIL SAMPLE RESULTS (0-2 ft.)
SEAD-71
SEAD-59 and SEAD-71 Phase II RI Report
Seneca Army Depot Activity

Facility	SEAD-71	SEAD-71	SEAD-71	SEAD-71	SEAD-71	SEAD-71
Location ID	CL-71-B-WE2	CL-71-B-WN1	CL-71-B-WS1	CL-71-B-WW1	CL-71-B-WW2	CL-71-C-F01
Maxtrix	SOIL	SOIL	SOIL	SOIL	SOIL	SOIL
Sample ID	CL-71-B-WE2	CL-71-B-WN1	CL-71-B-WS1	CL-71-B-WW1	CL-71-B-WW2	CL-71-C-F01
Sample Depth to Top of Sample ⁽¹⁾	0	0	0	0	0	0
Sample Depth to Bottom of Sample ⁽¹⁾	0	0	0	0	0	0
Sample Date	5/6/2004	5/6/2004	5/6/2004	5/6/2004	5/6/2004	5/6/2004
QC Code	SA	SA	SA	SA	SA	SA
Study ID	ENSR IRM	ENSR IRM	ENSR IRM	ENSR IRM	ENSR IRM	ENSR IRM
Sample Round	1	1	1	1	1	1

Parameter	Units	Maximum Frequency of		NYSDEC TAGM 4046 ⁽²⁾	Number of Exceedances	Number of Detects	Number of Analyses	Value (Q)	Value (Q)	Value (Q)	Value (Q)	Value (Q)	Value (Q)
		Value	Detection										
Aroclor-1221	UG/KG	0	0%		0	0	69	41 U	36 U	41 U	37 U	40 U	36 U
Aroclor-1232	UG/KG	0	0%		0	0	69	41 U	36 U	41 U	37 U	40 U	36 U
Aroclor-1242	UG/KG	0	0%		0	0	69	41 U	36 U	41 U	37 U	40 U	36 U
Aroclor-1248	UG/KG	0	0%		0	0	69	41 U	36 U	41 U	37 U	40 U	36 U
Aroclor-1254	UG/KG	0	0%	10000	0	0	69	41 U	36 U	41 U	37 U	40 U	36 U
Aroclor-1260	UG/KG	200	4%	10000	0	3	69	200 J	36 U	41 U	37 U	40 U	36 U
Metals													
Aluminum	MG/KG	18000	100%	19300	0	69	69	8110 J	13300 J	9640 J	8650 J	10600 J	10300
Antimony	MG/KG	19.3	49%	5.9	5	34	69	11.5 J	1.6 J	3.8 J	0.88 J	1.4 J	3.1 UJ
Arsenic	MG/KG	14.6	100%	8.2	5	69	69	6.2 J	5.9	6.7 J	4.9 J	6.2 J	5.1
Barium	MG/KG	179	100%	300	0	69	69	78.1 J	80.1 J	82.2 J	56.2 J	70.3 J	86.7
Beryllium	MG/KG	0.88	99%	1.1	0	68	69	0.46	0.67	0.51	0.42	0.55	0.33
Cadmium	MG/KG	12.1	67%	2.3	4	46	69	0.39	0.27 J	0.39	0.27 J	0.34 J	0.26 U
Calcium	MG/KG	295000	100%	121000	11	69	69	36700 J	9130 J	47800 J	54700 J	33800 J	22400
Chromium	MG/KG	60.3	100%	29.6	5	69	69	14 J	19 J	15.5 J	13.7 J	15.3 J	16.9
Cobalt	MG/KG	14.6	100%	30	0	69	69	8.2 J	11.2 J	9.2 J	8.1 J	9.6 J	9.6
Copper	MG/KG	134	100%	33	21	69	69	35.5 J	21.8 J	48.8 J	21.4 J	20.1 J	22.2
Cyanide	MG/KG	0	0%	0.35	0	0	24						
Iron	MG/KG	65100	100%	36500	2	69	69	15900 J	22800	20000 J	19700 J	20900 J	21300
Lead	MG/KG	3470	100%	24.8	33	69	69	635 J	17.9 J	452 J	17.9 J	14.3 J	17.1
Magnesium	MG/KG	59300	100%	21500	6	69	69	8170 J	4880 J	7260 J	11100 J	9110 J	6630
Manganese	MG/KG	1330	100%	1060	1	69	69	456 J	473 J	498 J	407 J	575 J	516
Mercury	MG/KG	2.7	80%	0.1	10	55	69	0.43 J	0.06	1 J	0.02 J	0.03 J	0.05
Nickel	MG/KG	110	100%	49	2	69	69	25.3 J	27 J	26.6 J	25 J	25.7 J	27.1
Potassium	MG/KG	2180	100%	2380	0	69	69	960 J	969	1110 J	869 J	918 J	1050
Selenium	MG/KG	1.8	19%	2	0	13	69	0.46 U	0.4 U	0.47 U	0.41 U	0.46 U	0.52 U
Silver	MG/KG	2.2	39%	0.75	15	27	69	0.74 J	1.2 J	0.55 J	0.32 J	0.75 J	0.52 U
Sodium	MG/KG	1040	97%	172	19	67	69	71.6 J	48.4	68.7	94.1 J	73.8 J	65.8
Thallium	MG/KG	2.3	26%	0.7	10	18	69	0.23 U	0.2 U	0.24 U	0.21 U	0.23 U	0.71 J
Vanadium	MG/KG	29.2	100%	150	0	69	69	15 J	19.9 J	24 J	13.4 J	16.5 J	16.8
Zinc	MG/KG	3660	99%	110	17	68	69	128 J	70	83.3 J	56 J	64.5 J	62.6

Note(s):
(1) - Historical sample depths are presented (I.e. prior to 2002 TCRA)
(2) - NYSDEC Technical and Administrative Guidance Memorandum (TAGM) HWR-94-4046

U = compound was not detected
J = the reported value is an estimated concentration

Table A-4A
SURFACE SOIL SAMPLE RESULTS (0-2 ft.)
SEAD-71
SEAD-59 and SEAD-71 Phase II RI Report
Seneca Army Depot Activity

Facility	SEAD-71	SEAD-71	SEAD-71	SEAD-71	SEAD-71	SEAD-71
Location ID	CL-71-B-WE2	CL-71-B-WN1	CL-71-B-WS1	CL-71-B-WW1	CL-71-B-WW2	CL-71-C-F01
Maxtrix	SOIL	SOIL	SOIL	SOIL	SOIL	SOIL
Sample ID	CL-71-B-WE2	CL-71-B-WN1	CL-71-B-WS1	CL-71-B-WW1	CL-71-B-WW2	CL-71-C-F01
Sample Depth to Top of Sample ⁽¹⁾	0	0	0	0	0	0
Sample Depth to Bottom of Sample ⁽¹⁾	0	0	0	0	0	0
Sample Date	5/6/2004	5/6/2004	5/6/2004	5/6/2004	5/6/2004	5/6/2004
QC Code	SA	SA	SA	SA	SA	SA
Study ID	ENSR IRM	ENSR IRM	ENSR IRM	ENSR IRM	ENSR IRM	ENSR IRM
Sample Round	1	1	1	1	1	1

Parameter	Units	Maximum Value	Frequency of Detection	NYSDEC TAGM 4046 ⁽²⁾	Number of Exceedances	Number of Detects	Number of Analyses	Value (Q)	Value (Q)	Value (Q)	Value (Q)	Value (Q)	Value (Q)

UJ = the compound was not detected; the associated reporting limit is approximate

R = the data was rejected in the data validating process

NJ = compound was "tentatively identified" and the associated numerical value is approximate

Table A-4A
SURFACE SOIL SAMPLE RESULTS (0-2 ft.)
SEAD-71
SEAD-59 and SEAD-71 Phase II RI Report
Seneca Army Depot Activity

Facility	SEAD-71	SEAD-71	SEAD-71	SEAD-71	SEAD-71	SEAD-71
Location ID	CL-71-C-F02	CL-71-C-WE1	CL-71-C-WE2	CL-71-C-WN1	CL-71-C-WS1	CL-71-C-WW2
Maxtrix	SOIL	SOIL	SOIL	SOIL	SOIL	SOIL
Sample ID	CL-71-C-F02	CL-71-C-WE1	CL-71-C-WE2	CL-71-C-WN1	CL-71-C-WS1	CL-71-C-WW2
Sample Depth to Top of Sample ⁽¹⁾	0	0	0	0	0	0
Sample Depth to Bottom of Sample ⁽¹⁾	0	0	0	0	0	0
Sample Date	5/6/2004	5/6/2004	5/6/2004	5/6/2004	5/6/2004	5/6/2004
QC Code	SA	SA	SA	SA	SA	SA
Study ID	ENSR IRM	ENSR IRM	ENSR IRM	ENSR IRM	ENSR IRM	ENSR IRM
Sample Round	1	1	1	1	1	1

Parameter	Units	Maximum Frequency of		NYSDEC TAGM 4046 ⁽²⁾	Number of Exceedances	Number of Detects	Number of Analyses	Value (Q)	Value (Q)	Value (Q)	Value (Q)	Value (Q)	Value (Q)
		Value	Detection										
Volatile Organics													
1,1,1-Trichloroethane	UG/KG	3	3%	800	0	2	68	5.5 U	5.5 U	5.5 U	5.4 U	5.4 U	5.6 U
1,1,2,2-Tetrachloroethane	UG/KG	0	0%	600	0	0	64	5.5 U	5.5 U	5.5 U	5.4 U	5.4 U	5.6 U
1,1,2-Trichloro-1,2,2-Trifluoroethane	UG/KG	0	0%		0	0	44	5.5 U	5.5 U	5.5 U	5.4 U	5.4 U	5.6 U
1,1,2-Trichloroethane	UG/KG	0	0%		0	0	47						
1,1-Dichloroethane	UG/KG	0	0%	200	0	0	68	5.5 U	5.5 U	5.5 U	5.4 U	5.4 U	5.6 U
1,1-Dichloroethene	UG/KG	0	0%	400	0	0	68	5.5 U	5.5 U	5.5 U	5.4 U	5.4 U	5.6 U
1,2,3-Trichloropropane	UG/KG	0	0%		0	0	21	5.5 U	5.5 U	5.5 U	5.4 U	5.4 U	5.6 U
1,2,4-Trichlorobenzene	UG/KG	0	0%	3400	0	0	40	5.5 U	5.5 U	5.5 U	5.4 U	5.4 U	5.6 U
1,2-Dibromo-3-chloropropane	UG/KG	0	0%		0	0	19						
1,2-Dibromoethane	UG/KG	0	0%		0	0	23						
1,2-Dichlorobenzene	UG/KG	0	0%	7900	0	0	40	5.5 U	5.5 U	5.5 U	5.4 U	5.4 U	5.6 U
1,2-Dichloroethane	UG/KG	0	0%	100	0	0	68	5.5 U	5.5 U	5.5 U	5.4 U	5.4 U	5.6 U
1,2-Dichloroethene (total)	UG/KG	0	0%		0	0	24						
1,2-Dichloropropane	UG/KG	0	0%		0	0	47						
1,3-Dichlorobenzene	UG/KG	0	0%	1600	0	0	40	5.5 U	5.5 U	5.5 U	5.4 U	5.4 U	5.6 U
1,3-Dichloropropane	UG/KG	0	0%		0	0	21	5.5 U	5.5 U	5.5 U	5.4 U	5.4 U	5.6 U
1,4-Dichlorobenzene	UG/KG	0	0%	8500	0	0	40	5.5 U	5.5 U	5.5 U	5.4 U	5.4 U	5.6 U
Acetone	UG/KG	74	13%	200	0	9	68	22 U	22 U	22 U	22 U	22 U	22 U
Benzene	UG/KG	2	3%	60	0	2	68	5.5 U	5.5 U	5.5 U	5.4 U	5.4 U	5.6 U
Bromodichloromethane	UG/KG	0	0%		0	0	47						
Bromoform	UG/KG	0	0%		0	0	47						
Carbon disulfide	UG/KG	5	4%	2700	0	3	68	5.5 U	5.5 U	5.5 U	5.4 U	5.4 U	5.6 U
Carbon tetrachloride	UG/KG	0	0%	600	0	0	68	5.5 U	5.5 U	5.5 U	5.4 U	5.4 U	5.6 U
Chlorobenzene	UG/KG	0	0%	1700	0	0	68	5.5 U	5.5 U	5.5 U	5.4 U	5.4 U	5.6 U
Chlorodibromomethane	UG/KG	0	0%		0	0	68	5.5 U	5.5 U	5.5 U	5.4 U	5.4 U	5.6 U
Chloroethane	UG/KG	0	0%	1900	0	0	68	11 U	11 U	11 U	11 U	11 U	11 U
Chloroform	UG/KG	0	0%	300	0	0	68	5.5 U	5.5 U	5.5 U	5.4 U	5.4 U	5.6 U
Cis-1,2-Dichloroethene	UG/KG	0	0%		0	0	23						
Cis-1,3-Dichloropropene	UG/KG	0	0%		0	0	47						
Cyclohexane	UG/KG	4	9%		0	2	23						
Dichlorodifluoromethane	UG/KG	0	0%		0	0	23						
Ethyl benzene	UG/KG	4	3%	5500	0	2	68	5.5 U	5.5 U	5.5 U	5.4 U	5.4 U	5.6 U
Isopropylbenzene	UG/KG	0	0%		0	0	23						
Meta/Para Xylene	UG/KG	0	0%		0	0	21	5.5 U	5.5 U	5.5 U	5.4 U	5.4 U	5.6 U
Methyl Acetate	UG/KG	0	0%		0	0	23						
Methyl Tertbutyl Ether	UG/KG	0	0%		0	0	23						
Methyl bromide	UG/KG	0	0%		0	0	47						

Table A-4A
SURFACE SOIL SAMPLE RESULTS (0-2 ft.)
SEAD-71
SEAD-59 and SEAD-71 Phase II RI Report
Seneca Army Depot Activity

Facility	SEAD-71	SEAD-71	SEAD-71	SEAD-71	SEAD-71	SEAD-71
Location ID	CL-71-C-F02	CL-71-C-WE1	CL-71-C-WE2	CL-71-C-WN1	CL-71-C-WS1	CL-71-C-WW2
Maxtrix	SOIL	SOIL	SOIL	SOIL	SOIL	SOIL
Sample ID	CL-71-C-F02	CL-71-C-WE1	CL-71-C-WE2	CL-71-C-WN1	CL-71-C-WS1	CL-71-C-WW2
Sample Depth to Top of Sample ⁽¹⁾	0	0	0	0	0	0
Sample Depth to Bottom of Sample ⁽¹⁾	0	0	0	0	0	0
Sample Date	5/6/2004	5/6/2004	5/6/2004	5/6/2004	5/6/2004	5/6/2004
QC Code	SA	SA	SA	SA	SA	SA
Study ID	ENSR IRM	ENSR IRM	ENSR IRM	ENSR IRM	ENSR IRM	ENSR IRM
Sample Round	1	1	1	1	1	1

Parameter	Units	Maximum Frequency of		NYSDEC TAGM 4046 ⁽²⁾	Number of Exceedances	Number of Detects	Number of Analyses	Value (Q)	Value (Q)	Value (Q)	Value (Q)	Value (Q)	Value (Q)
		Value	Detection										
Methyl butyl ketone	UG/KG	0	0%		0	0	47						
Methyl chloride	UG/KG	0	0%		0	0	47						
Methyl cyclohexane	UG/KG	6	13%		0	3	23						
Methyl ethyl ketone	UG/KG	0	0%	300	0	0	68	11 U	11 U	11 U	11 U	11 U	11 U
Methyl isobutyl ketone	UG/KG	0	0%	1000	0	0	68	11 U	11 U	11 U	11 U	11 U	11 U
Methylene chloride	UG/KG	11	12%	100	0	8	68	5.5 U	5.5 U	5.5 U	5.4 U	5.4 U	5.6 U
Ortho Xylene	UG/KG	0	0%		0	0	21	5.5 U	5.5 U	5.5 U	5.4 U	5.4 U	5.6 U
Styrene	UG/KG	1	2%		0	1	47						
Tetrachloroethene	UG/KG	33	1%	1400	0	1	68	5.5 U	5.5 U	5.5 U	5.4 U	5.4 U	5.6 U
Toluene	UG/KG	16	16%	1500	0	11	68	5.5 U	5.5 U	5.5 U	5.4 U	5.4 U	5.6 U
Total BTEX	MG/KG	11.6	100%		0	1	1						
Total Xylenes	UG/KG	11	11%	1200	0	5	44						
Trans-1,2-Dichloroethene	UG/KG	0	0%	300	0	0	44	5.5 U	5.5 U	5.5 U	5.4 U	5.4 U	5.6 U
Trans-1,3-Dichloropropene	UG/KG	0	0%		0	0	47						
Trichloroethene	UG/KG	0	0%	700	0	0	68	5.5 U	5.5 U	5.5 U	5.4 U	5.4 U	5.6 U
Trichlorofluoromethane	UG/KG	1	4%		0	1	23						
Vinyl chloride	UG/KG	0	0%	200	0	0	68	11 U	11 U	11 U	11 U	11 U	11 U
Semivolatile Organics													
1,1'-Biphenyl	UG/KG	0	0%		0	0	23						
1,2,4-Trichlorobenzene	UG/KG	0	0%	3400	0	0	24						
1,2-Dichlorobenzene	UG/KG	0	0%	7900	0	0	24						
1,3-Dichlorobenzene	UG/KG	0	0%	1600	0	0	24						
1,4-Dichlorobenzene	UG/KG	0	0%	8500	0	0	24						
2,2'-oxybis(1-Chloropropane)	UG/KG	0	0%		0	0	27						
2,4,5-Trichlorophenol	UG/KG	0	0%	100	0	0	69	360 U	360 U	360 U	1800 U	1800 U	370 U
2,4,6-Trichlorophenol	UG/KG	0	0%		0	0	69	360 U	360 U	360 U	1800 U	1800 U	370 U
2,4-Dichlorophenol	UG/KG	0	0%	400	0	0	69	360 U	360 U	360 U	1800 U	1800 U	370 U
2,4-Dimethylphenol	UG/KG	0	0%		0	0	47						
2,4-Dinitrophenol	UG/KG	0	0%	200	0	0	69	1900 U	1900 U	1900 U	9200 U	9200 U	1900 U
2,4-Dinitrotoluene	UG/KG	880	1%		0	1	69	360 U	360 U	360 U	1800 U	1800 U	370 U
2,6-Dinitrotoluene	UG/KG	0	0%	1000	0	0	69	360 U	360 U	360 U	1800 U	1800 U	370 U
2-Chloronaphthalene	UG/KG	0	0%		0	0	47						
2-Chlorophenol	UG/KG	0	0%	800	0	0	69	360 U	360 U	360 U	1800 U	1800 U	370 U
2-Methylnaphthalene	UG/KG	19000	22%	36400	0	15	69	360 U	360 U	360 U	1800 U	770 J	370 U
2-Methylphenol	UG/KG	0	0%	100	0	0	69	360 U	360 U	360 U	1800 U	1800 U	370 U
2-Nitroaniline	UG/KG	0	0%	430	0	0	69	1900 U	1900 U	1900 U	9200 U	9200 U	1900 U
2-Nitrophenol	UG/KG	0	0%	330	0	0	69	360 U	360 U	360 U	1800 U	1800 U	370 U
3,3'-Dichlorobenzidine	UG/KG	0	0%		0	0	69	360 U	360 U	360 U	1800 U	1800 U	370 U

Table A-4A
SURFACE SOIL SAMPLE RESULTS (0-2 ft.)
SEAD-71
SEAD-59 and SEAD-71 Phase II RI Report
Seneca Army Depot Activity

Facility	SEAD-71	SEAD-71	SEAD-71	SEAD-71	SEAD-71	SEAD-71
Location ID	CL-71-C-F02	CL-71-C-WE1	CL-71-C-WE2	CL-71-C-WN1	CL-71-C-WS1	CL-71-C-WW2
Maxtrix	SOIL	SOIL	SOIL	SOIL	SOIL	SOIL
Sample ID	CL-71-C-F02	CL-71-C-WE1	CL-71-C-WE2	CL-71-C-WN1	CL-71-C-WS1	CL-71-C-WW2
Sample Depth to Top of Sample ⁽¹⁾	0	0	0	0	0	0
Sample Depth to Bottom of Sample ⁽¹⁾	0	0	0	0	0	0
Sample Date	5/6/2004	5/6/2004	5/6/2004	5/6/2004	5/6/2004	5/6/2004
QC Code	SA	SA	SA	SA	SA	SA
Study ID	ENSR IRM	ENSR IRM	ENSR IRM	ENSR IRM	ENSR IRM	ENSR IRM
Sample Round	1	1	1	1	1	1

Parameter	Units	Maximum Frequency of		NYSDEC TAGM 4046 ⁽²⁾	Number of Exceedances	Number of Detects	Number of Analyses	Value (Q)	Value (Q)	Value (Q)	Value (Q)	Value (Q)	Value (Q)
		Value	Detection										
3-Nitroaniline	UG/KG	0	0%	500	0	0	69	1900 U	1900 U	1900 U	9200 U	9200 U	1900 U
4,6-Dinitro-2-methylphenol	UG/KG	0	0%		0	0	47						
4-Bromophenyl phenyl ether	UG/KG	0	0%		0	0	47						
4-Chloro-3-methylphenol	UG/KG	0	0%	240	0	0	69	360 U	360 U	360 U	1800 U	1800 U	370 U
4-Chloroaniline	UG/KG	0	0%	220	0	0	69	360 U	360 U	360 U	1800 U	1800 U	370 U
4-Chlorophenyl phenyl ether	UG/KG	0	0%		0	0	47						
4-Methylphenol	UG/KG	0	0%	900	0	0	69	360 U	360 U	360 U	1800 U	1800 U	370 U
4-Nitroaniline	UG/KG	75	2%		0	1	47						
4-Nitrophenol	UG/KG	0	0%	100	0	0	69	1900 U	1900 U	1900 U	9200 U	9200 U	1900 U
Acenaphthene	UG/KG	42000	42%	50000	0	29	69	360 U	360 U	360 U	1800 U	1500 J	370 U
Acenaphthylene	UG/KG	1800	28%	41000	0	19	69	120 J	360 U	360 U	1800	1500 J	44 J
Acetophenone	UG/KG	0	0%		0	0	23						
Aniline	UG/KG	0	0%		0	0	22	360 U	360 U	360 U	1800 U	1800 U	370 U
Anthracene	UG/KG	100000	59%	50000	3	41	69	77 J	360 U	360 U	1100 J	5000	370 U
Atrazine	UG/KG	0	0%		0	0	23						
Benzaldehyde	UG/KG	0	0%		0	0	23						
Benzo(a)anthracene	UG/KG	150000	77%	224	40	53	69	310 J	360 U	360 U	4700	10000	130 J
Benzo(a)pyrene	UG/KG	120000	77%	61	47	53	69	500	360 U	360 U	6500	9000	170 J
Benzo(b)fluoranthene	UG/KG	88000	78%	1100	23	54	69	520	40 J	360 U	5900	6700	140 J
Benzo(ghi)perylene	UG/KG	62000	70%	50000	1	48	69	590	360 U	360 U	5800	5200	120 J
Benzo(k)fluoranthene	UG/KG	130000	61%	1100	20	42	69	460	360 U	360 U	5500	7700	140 J
Benzoic Acid	UG/KG	0	0%	2700	0	0	22	1900 U	1900 U	1900 U	9200 U	9200 U	1900 U
Bis(2-Chloroethoxy)methane	UG/KG	0	0%		0	0	47						
Bis(2-Chloroethyl)ether	UG/KG	0	0%		0	0	47						
Bis(2-Chloroisopropyl)ether	UG/KG	0	0%		0	0	20						
Bis(2-Ethylhexyl)phthalate	UG/KG	140	9%	50000	0	6	69	360 U	360 U	360 U	1800 U	1800 U	370 U
Butylbenzylphthalate	UG/KG	0	0%	50000	0	0	69	360 U	360 U	360 U	1800 U	1800 U	370 U
Caprolactam	UG/KG	0	0%		0	0	23						
Carbazole	UG/KG	77000	57%		0	27	47						
Chrysene	UG/KG	150000	81%	400	37	56	69	510	45 J	360 U	6300	10000	150 J
Di-n-butylphthalate	UG/KG	140	6%	8100	0	4	69	360 U	41 J	70 J	1800 U	1800 U	370 U
Di-n-octylphthalate	UG/KG	0	0%	50000	0	0	69	360 U	360 U	360 U	1800 U	1800 U	370 U
Dibenz(a,h)anthracene	UG/KG	25000	58%	14	40	40	69	140 J	360 U	360 U	1700 J	1900 J	44 J
Dibenzofuran	UG/KG	38000	39%	6200	4	27	69	360 U	360 U	360 U	1800 U	1400 J	370 U
Diethyl phthalate	UG/KG	0	0%	7100	0	0	69	360 U	360 U	360 U	1800 U	1800 U	370 U
Dimethylphthalate	UG/KG	0	0%	2000	0	0	69	360 U	360 U	360 U	1800 U	1800 U	370 U
Fluoranthene	UG/KG	440000	84%	50000	6	58	69	370 J	50 J	360 U	7700	27000	200 J
Fluorene	UG/KG	62000	41%	50000	1	28	69	360 U	360 U	360 U	1800 U	2500	370 U

Table A-4A
SURFACE SOIL SAMPLE RESULTS (0-2 ft.)
SEAD-71
SEAD-59 and SEAD-71 Phase II RI Report
Seneca Army Depot Activity

Facility	SEAD-71	SEAD-71	SEAD-71	SEAD-71	SEAD-71	SEAD-71
Location ID	CL-71-C-F02	CL-71-C-WE1	CL-71-C-WE2	CL-71-C-WN1	CL-71-C-WS1	CL-71-C-WW2
Maxtrix	SOIL	SOIL	SOIL	SOIL	SOIL	SOIL
Sample ID	CL-71-C-F02	CL-71-C-WE1	CL-71-C-WE2	CL-71-C-WN1	CL-71-C-WS1	CL-71-C-WW2
Sample Depth to Top of Sample ⁽¹⁾	0	0	0	0	0	0
Sample Depth to Bottom of Sample ⁽¹⁾	0	0	0	0	0	0
Sample Date	5/6/2004	5/6/2004	5/6/2004	5/6/2004	5/6/2004	5/6/2004
QC Code	SA	SA	SA	SA	SA	SA
Study ID	ENSR IRM	ENSR IRM	ENSR IRM	ENSR IRM	ENSR IRM	ENSR IRM
Sample Round	1	1	1	1	1	1

Parameter	Units	Maximum Frequency of		NYSDEC TAGM 4046 ⁽²⁾	Number of Exceedances	Number of Detects	Number of Analyses	Value (Q)	Value (Q)	Value (Q)	Value (Q)	Value (Q)	Value (Q)
		Value	Detection										
Hexachlorobenzene	UG/KG	0	0%	410	0	0	69	360 U	360 U	360 U	1800 U	1800 U	370 U
Hexachlorobutadiene	UG/KG	0	0%		0	0	69	360 U	360 U	360 U	1800 U	1800 U	370 U
Hexachlorocyclopentadiene	UG/KG	0	0%		0	0	47						
Hexachloroethane	UG/KG	0	0%		0	0	69	360 U	360 U	360 U	1800 U	1800 U	370 U
Indeno(1,2,3-cd)pyrene	UG/KG	65000	70%	3200	11	48	69	450 J	360 U	360 U	4900 J	5200 J	110 J
Isophorone	UG/KG	0	0%	4400	0	0	69	360 U	360 U	360 U	1800 U	1800 U	370 U
N-Nitrosodiphenylamine	UG/KG	0	0%		0	0	47						
N-Nitrosodipropylamine	UG/KG	0	0%		0	0	47						
Naphthalene	UG/KG	46000	22%	13000	1	15	69	360 U	360 U	360 U	1800 U	1100 J	370 U
Nitrobenzene	UG/KG	0	0%	200	0	0	69	360 U	360 U	360 U	1800 U	1800 U	370 U
Pentachlorophenol	UG/KG	0	0%	1000	0	0	69	1900 U	1900 U	1900 U	9200 U	9200 U	1900 U
Phenanthrene	UG/KG	290000	78%	50000	5	54	69	71 J	360 U	360 U	1300 J	25000	81 J
Phenol	UG/KG	4.5	1%	30	0	1	69	360 U	360 U	360 U	1800 U	1800 U	370 U
Pyrene	UG/KG	280000	81%	50000	6	56	69	400	43 J	360 U	8100	20000	200 J
Pyridine	UG/KG	0	0%		0	0	22	1900 U	1900 U	1900 U	9200 U	9200 U	1900 U
Pesticides/PCBs													
4,4'-DDD	UG/KG	240	26%	2900	0	18	69	22 U	22 U	22 U	21 U	21 U	22 U
4,4'-DDE	UG/KG	810	42%	2100	0	29	69	22 U	22 U	22 U	21 U	21 U	22 U
4,4'-DDT	UG/KG	1300	51%	2100	0	35	69	22 U	22 U	22 U	59	22 J	22 U
Aldrin	UG/KG	0	0%	41	0	0	69	11 U	11 U	11 U	11 U	11 U	11 U
Alpha-BHC	UG/KG	18	7%	110	0	5	69	11 U	11 U	11 U	11 U	11 U	11 U
Alpha-Chlordane	UG/KG	2	1%		0	1	69	11 U	11 U	11 U	11 U	11 U	11 U
Beta-BHC	UG/KG	35	9%	200	0	6	69	11 U	11 U	11 U	11 U	11 U	11 U
Delta-BHC	UG/KG	0	0%	300	0	0	69	11 U	11 U	11 U	11 U	11 U	11 U
Dieldrin	UG/KG	3.4	3%	44	0	2	69	22 U	22 U	22 U	21 U	21 U	22 U
Endosulfan I	UG/KG	15	10%	900	0	7	69	11 U	11 U	11 U	11 U	11 U	11 U
Endosulfan II	UG/KG	52	4%	900	0	3	69	22 U	22 U	22 U	21 U	21 U	22 U
Endosulfan sulfate	UG/KG	110	16%	1000	0	11	69	22 U	22 U	22 U	21 U	21 U	22 U
Endrin	UG/KG	120	14%	100	1	10	69	22 U	22 U	22 U	21 U	21 U	22 U
Endrin aldehyde	UG/KG	120	23%		0	16	69	22 U	22 U	22 U	21 U	21 U	22 U
Endrin ketone	UG/KG	180	22%		0	15	69	22 U	22 U	22 U	21 U	21 U	22 U
Gamma-BHC/Lindane	UG/KG	0	0%	60	0	0	69	11 U	11 U	11 U	11 U	11 U	11 U
Gamma-Chlordane	UG/KG	48	6%	540	0	4	69	11 U	11 U	11 U	11 U	11 U	11 U
Heptachlor	UG/KG	0	0%	100	0	0	69	11 U	11 U	11 U	11 U	11 U	11 U
Heptachlor epoxide	UG/KG	180	17%	20	4	12	69	11 U	11 U	11 U	11 U	11 U	11 U
Methoxychlor	UG/KG	520	16%		0	11	69	110 U	110 U	110 U	110 U	110 U	110 U
Toxaphene	UG/KG	0	0%		0	0	69	220 U	220 U	220 U	210 U	210 U	220 U
Aroclor-1016	UG/KG	0	0%		0	0	69	36 U	36 U	36 U	36 U	36 U	37 U

Table A-4A
SURFACE SOIL SAMPLE RESULTS (0-2 ft.)
SEAD-71
SEAD-59 and SEAD-71 Phase II RI Report
Seneca Army Depot Activity

Facility	SEAD-71	SEAD-71	SEAD-71	SEAD-71	SEAD-71	SEAD-71
Location ID	CL-71-C-F02	CL-71-C-WE1	CL-71-C-WE2	CL-71-C-WN1	CL-71-C-WN1	CL-71-C-WW2
Maxtrix	SOIL	SOIL	SOIL	SOIL	SOIL	SOIL
Sample ID	CL-71-C-F02	CL-71-C-WE1	CL-71-C-WE2	CL-71-C-WN1	CL-71-C-WN1	CL-71-C-WW2
Sample Depth to Top of Sample ⁽¹⁾	0	0	0	0	0	0
Sample Depth to Bottom of Sample ⁽¹⁾	0	0	0	0	0	0
Sample Date	5/6/2004	5/6/2004	5/6/2004	5/6/2004	5/6/2004	5/6/2004
QC Code	SA	SA	SA	SA	SA	SA
Study ID	ENSR IRM	ENSR IRM	ENSR IRM	ENSR IRM	ENSR IRM	ENSR IRM
Sample Round	1	1	1	1	1	1

Parameter	Units	Maximum Frequency of		NYSDEC TAGM 4046 ⁽²⁾	Number of Exceedances	Number of Detects	Number of Analyses	Value (Q)	Value (Q)	Value (Q)	Value (Q)	Value (Q)	Value (Q)
		Value	Detection										
Aroclor-1221	UG/KG	0	0%		0	0	69	36 U	36 U	36 U	36 U	36 U	37 U
Aroclor-1232	UG/KG	0	0%		0	0	69	36 U	36 U	36 U	36 U	36 U	37 U
Aroclor-1242	UG/KG	0	0%		0	0	69	36 U	36 U	36 U	36 U	36 U	37 U
Aroclor-1248	UG/KG	0	0%		0	0	69	36 U	36 U	36 U	36 U	36 U	37 U
Aroclor-1254	UG/KG	0	0%	10000	0	0	69	36 U	36 U	36 U	36 U	36 U	37 U
Aroclor-1260	UG/KG	200	4%	10000	0	3	69	36 U	36 U	36 U	36 U	120	37 U
Metals													
Aluminum	MG/KG	18000	100%	19300	0	69	69	12200	12600	13500	10000	6370	12100
Antimony	MG/KG	19.3	49%	5.9	5	34	69	3.2 UJ	3.1 UJ	3.3 UJ	3.2 UJ	3.2 UJ	3.3 UJ
Arsenic	MG/KG	14.6	100%	8.2	5	69	69	6.4	4.5	5.1	8	11.8	5.3
Barium	MG/KG	179	100%	300	0	69	69	68.3	80	115	114	59.2	75.4
Beryllium	MG/KG	0.88	99%	1.1	0	68	69	0.35	0.46	0.44	0.31	0.11	0.4
Cadmium	MG/KG	12.1	67%	2.3	4	46	69	0.27 U	0.26 U	0.32 J	0.7	0.49 J	0.28 U
Calcium	MG/KG	295000	100%	121000	11	69	69	6860	11600	14100	47400	66300	11800
Chromium	MG/KG	60.3	100%	29.6	5	69	69	21	18.8	19.5	37.1	18.5	19.3
Cobalt	MG/KG	14.6	100%	30	0	69	69	11.1	8.6	11.5	10.3	8.2	10.6
Copper	MG/KG	134	100%	33	21	69	69	21.7	17.2	16.4	67.7	32.3	21.2
Cyanide	MG/KG	0	0%	0.35	0	0	24						
Iron	MG/KG	65100	100%	36500	2	69	69	26300	21800	25500	28300	15600	23300
Lead	MG/KG	3470	100%	24.8	33	69	69	18.6	21.5	12.4	169	188	16.1
Magnesium	MG/KG	59300	100%	21500	6	69	69	4440	3800	4400	4940	14300	5490
Manganese	MG/KG	1330	100%	1060	1	69	69	538	467	1040	641	460	488
Mercury	MG/KG	2.7	80%	0.1	10	55	69	0.03	0.05	0.03	0.11	0.04	0.04
Nickel	MG/KG	110	100%	49	2	69	69	31.3	24.2	26.8	28.6	29.6	30.3
Potassium	MG/KG	2180	100%	2380	0	69	69	1170	918	1090	1150	1020	1020
Selenium	MG/KG	1.8	19%	2	0	13	69	0.53 U	0.52 U	0.55 U	0.53 U	1.3	0.56 U
Silver	MG/KG	2.2	39%	0.75	15	27	69	0.53 U	0.52 U	0.55 U	0.53 U	0.53 U	0.56 U
Sodium	MG/KG	1040	97%	172	19	67	69	42.5 J	45.3 J	43.1 J	141	139	40.3 J
Thallium	MG/KG	2.3	26%	0.7	10	18	69	0.67 J	0.71 J	1 J	1 J	0.68 J	0.75 J
Vanadium	MG/KG	29.2	100%	150	0	69	69	20.1	19.9	21.5	19.4	16.4	20
Zinc	MG/KG	3660	99%	110	17	68	69	89.9	69.3	75.7	161	357	66.5

Note(s):

- (1) - Historical sample depths are presented (I.e. prior to 2002 TCRA)
- (2) - NYSDEC Technical and Administrative Guidance Memorandum (TAGM) HWR-94-4046

U = compound was not detected
J = the reported value is an estimated concentration

Table A-4A
SURFACE SOIL SAMPLE RESULTS (0-2 ft.)
SEAD-71
SEAD-59 and SEAD-71 Phase II RI Report
Seneca Army Depot Activity

Facility	SEAD-71	SEAD-71	SEAD-71	SEAD-71	SEAD-71	SEAD-71
Location ID	CL-71-C-F02	CL-71-C-WE1	CL-71-C-WE2	CL-71-C-WN1	CL-71-C-WS1	CL-71-C-WW2
Maxtrix	SOIL	SOIL	SOIL	SOIL	SOIL	SOIL
Sample ID	CL-71-C-F02	CL-71-C-WE1	CL-71-C-WE2	CL-71-C-WN1	CL-71-C-WS1	CL-71-C-WW2
Sample Depth to Top of Sample ⁽¹⁾	0	0	0	0	0	0
Sample Depth to Bottom of Sample ⁽¹⁾	0	0	0	0	0	0
Sample Date	5/6/2004	5/6/2004	5/6/2004	5/6/2004	5/6/2004	5/6/2004
QC Code	SA	SA	SA	SA	SA	SA
Study ID	ENSR IRM	ENSR IRM	ENSR IRM	ENSR IRM	ENSR IRM	ENSR IRM
Sample Round	1	1	1	1	1	1

Parameter	Units	Maximum Value	Frequency of Detection	NYSDEC TAGM 4046 ⁽²⁾	Number of Exceedances	Number of Detects	Number of Analyses	Value (Q)	Value (Q)	Value (Q)	Value (Q)	Value (Q)	Value (Q)

UJ = the compound was not detected; the associated reporting limit is approximate

R = the data was rejected in the data validating process

NJ = compound was "tentatively identified" and the associated numerical value is approximate

Table A-4A
SURFACE SOIL SAMPLE RESULTS (0-2 ft.)
SEAD-71
SEAD-59 and SEAD-71 Phase II RI Report
Seneca Army Depot Activity

Facility	SEAD-71	SEAD-71	SEAD-71	SEAD-71	SEAD-71	SEAD-71
Location ID	CL-71-D-F01	CL-71-D-WE1	CL-71-D-WN1	CL-71-D-WS1	CL-71-D-WW3	CL-71-E1-F01
Maxtrix	SOIL	SOIL	SOIL	SOIL	SOIL	SOIL
Sample ID	CL-71-D-F01	CL-71-D-WE1	CL-71-D-WN1	CL-71-D-WS1	CL-71-D-WW3	CL-71-E1-F01
Sample Depth to Top of Sample ⁽¹⁾	0	0	0	0	0	0
Sample Depth to Bottom of Sample ⁽¹⁾	0	0	0	0	0	0
Sample Date	5/6/2004	5/6/2004	5/6/2004	5/6/2004	5/6/2004	5/6/2004
QC Code	SA	SA	SA	SA	SA	SA
Study ID	ENSR IRM	ENSR IRM	ENSR IRM	ENSR IRM	ENSR IRM	ENSR IRM
Sample Round	1	1	1	1	1	1

Parameter	Units	Maximum Frequency of		NYSDEC TAGM 4046 ⁽²⁾	Number of Exceedances	Number of Detects	Number of Analyses	Value (Q)	Value (Q)	Value (Q)	Value (Q)	Value (Q)	Value (Q)
		Value	Detection										
Volatile Organics													
1,1,1-Trichloroethane	UG/KG	3	3%	800	0	2	68	5 U	5 U	5 U	5 U		5.5 U
1,1,2,2-Tetrachloroethane	UG/KG	0	0%	600	0	0	64	5 UJ	5 UJ	5 UJ	5 UJ		5.5 U
1,1,2-Trichloro-1,2,2-Trifluoroethane	UG/KG	0	0%		0	0	44	5 U	5 U	5 U	5 U		5.5 U
1,1,2-Trichloroethane	UG/KG	0	0%		0	0	47	5 U	5 U	5 U	5 U		5.5 U
1,1-Dichloroethane	UG/KG	0	0%	200	0	0	68	5 U	5 U	5 U	5 U		5.5 U
1,1-Dichloroethene	UG/KG	0	0%	400	0	0	68	5 U	5 U	5 U	5 U		5.5 U
1,2,3-Trichloropropane	UG/KG	0	0%		0	0	21						5.5 U
1,2,4-Trichlorobenzene	UG/KG	0	0%	3400	0	0	40	5 UJ	5 UJ	5 UJ	5 UJ		5.5 U
1,2-Dibromo-3-chloropropane	UG/KG	0	0%		0	0	19	5 UJ	5 UJ	5 UJ	5 UJ		5.5 U
1,2-Dibromoethane	UG/KG	0	0%		0	0	23	5 U	5 U	5 U	5 U		5.5 U
1,2-Dichlorobenzene	UG/KG	0	0%	7900	0	0	40	5 UJ	5 UJ	5 UJ	5 UJ		5.5 U
1,2-Dichloroethane	UG/KG	0	0%	100	0	0	68	5 U	5 U	5 U	5 U		5.5 U
1,2-Dichloroethene (total)	UG/KG	0	0%		0	0	24						5.5 U
1,2-Dichloropropane	UG/KG	0	0%		0	0	47	5 U	5 U	5 U	5 U		5.5 U
1,3-Dichlorobenzene	UG/KG	0	0%	1600	0	0	40	5 UJ	5 UJ	5 UJ	5 UJ		5.5 U
1,3-Dichloropropane	UG/KG	0	0%		0	0	21						5.5 U
1,4-Dichlorobenzene	UG/KG	0	0%	8500	0	0	40	5 UJ	5 UJ	5 UJ	5 UJ		5.5 U
Acetone	UG/KG	74	13%	200	0	9	68	5 U	5 U	5 U	5 U		22 U
Benzene	UG/KG	2	3%	60	0	2	68	5 U	5 U	5 U	5 U		5.5 U
Bromodichloromethane	UG/KG	0	0%		0	0	47	5 U	5 U	5 U	5 U		5.5 U
Bromoform	UG/KG	0	0%		0	0	47	5 U	5 U	5 U	5 U		5.5 U
Carbon disulfide	UG/KG	5	4%	2700	0	3	68	5 U	5 U	5 U	5 U		5.5 U
Carbon tetrachloride	UG/KG	0	0%	600	0	0	68	5 U	5 U	5 U	5 U		5.5 U
Chlorobenzene	UG/KG	0	0%	1700	0	0	68	5 U	5 U	5 U	5 U		5.5 U
Chlorodibromomethane	UG/KG	0	0%		0	0	68	5 U	5 U	5 U	5 U		5.5 U
Chloroethane	UG/KG	0	0%	1900	0	0	68	5 U	5 U	5 U	5 U		11 U
Chloroform	UG/KG	0	0%	300	0	0	68	5 U	5 U	5 U	5 U		5.5 U
Cis-1,2-Dichloroethene	UG/KG	0	0%		0	0	23	5 U	5 U	5 U	5 U		5.5 U
Cis-1,3-Dichloropropene	UG/KG	0	0%		0	0	47	5 U	5 U	5 U	5 U		5.5 U
Cyclohexane	UG/KG	4	9%		0	2	23	5 U	5 U	5 U	5 U		5.5 U
Dichlorodifluoromethane	UG/KG	0	0%		0	0	23	5 U	5 U	5 U	5 U		5.5 U
Ethyl benzene	UG/KG	4	3%	5500	0	2	68	5 U	5 U	5 U	5 U		5.5 U
Isopropylbenzene	UG/KG	0	0%		0	0	23	5 U	5 U	5 U	5 U		5.5 U
Meta/Para Xylene	UG/KG	0	0%		0	0	21						5.5 U
Methyl Acetate	UG/KG	0	0%		0	0	23	5 U	5 U	5 U	5 U		5.5 U
Methyl Tertbutyl Ether	UG/KG	0	0%		0	0	23	5 U	5 U	5 U	5 U		5.5 U
Methyl bromide	UG/KG	0	0%		0	0	47	5 U	5 U	5 U	5 U		5.5 U

Table A-4A
SURFACE SOIL SAMPLE RESULTS (0-2 ft.)
SEAD-71
SEAD-59 and SEAD-71 Phase II RI Report
Seneca Army Depot Activity

Facility	SEAD-71	SEAD-71	SEAD-71	SEAD-71	SEAD-71	SEAD-71
Location ID	CL-71-D-F01	CL-71-D-WE1	CL-71-D-WN1	CL-71-D-WS1	CL-71-D-WW3	CL-71-E1-F01
Maxtrix	SOIL	SOIL	SOIL	SOIL	SOIL	SOIL
Sample ID	CL-71-D-F01	CL-71-D-WE1	CL-71-D-WN1	CL-71-D-WS1	CL-71-D-WW3	CL-71-E1-F01
Sample Depth to Top of Sample ⁽¹⁾	0	0	0	0	0	0
Sample Depth to Bottom of Sample ⁽¹⁾	0	0	0	0	0	0
Sample Date	5/6/2004	5/6/2004	5/6/2004	5/6/2004	5/6/2004	5/6/2004
QC Code	SA	SA	SA	SA	SA	SA
Study ID	ENSR IRM	ENSR IRM	ENSR IRM	ENSR IRM	ENSR IRM	ENSR IRM
Sample Round	1	1	1	1	1	1

Parameter	Units	Maximum Frequency of		NYSDEC TAGM 4046 ⁽²⁾	Number of Exceedances	Number of Detects	Number of Analyses	Value (Q)	Value (Q)	Value (Q)	Value (Q)	Value (Q)	Value (Q)
		Value	Detection										
Methyl butyl ketone	UG/KG	0	0%		0	0	47	5 U	5 U	5 U	5 U		
Methyl chloride	UG/KG	0	0%		0	0	47	5 U	5 U	5 U	5 U		
Methyl cyclohexane	UG/KG	6	13%		0	3	23	5 U	5 U	5 U	5 U		
Methyl ethyl ketone	UG/KG	0	0%	300	0	0	68	5 U	5 U	5 U	5 U		11 U
Methyl isobutyl ketone	UG/KG	0	0%	1000	0	0	68	5 U	5 U	5 U	5 U		11 U
Methylene chloride	UG/KG	11	12%	100	0	8	68	5 U	5 U	5 U	5 U		5.5 U
Ortho Xylene	UG/KG	0	0%		0	0	21						5.5 U
Styrene	UG/KG	1	2%		0	1	47	5 U	5 U	5 U	5 U		
Tetrachloroethene	UG/KG	33	1%	1400	0	1	68	5 U	5 U	5 U	5 U		5.5 U
Toluene	UG/KG	16	16%	1500	0	11	68	5 U	5 U	5 U	5 U		5.5 U
Total BTEX	MG/KG	11.6	100%		0	1	1						
Total Xylenes	UG/KG	11	11%	1200	0	5	44	5 UJ	5 UJ	5 UJ	5 UJ		
Trans-1,2-Dichloroethene	UG/KG	0	0%	300	0	0	44	5 U	5 U	5 U	5 U		5.5 U
Trans-1,3-Dichloropropene	UG/KG	0	0%		0	0	47	5 U	5 U	5 U	5 U		
Trichloroethene	UG/KG	0	0%	700	0	0	68	5 U	5 U	5 U	5 U		5.5 U
Trichlorofluoromethane	UG/KG	1	4%		0	1	23	5 U	5 U	5 U	5 U		
Vinyl chloride	UG/KG	0	0%	200	0	0	68	5 U	5 U	5 U	5 U		11 U
Semivolatile Organics													
1,1'-Biphenyl	UG/KG	0	0%		0	0	23	360 U	370 U	350 U	360 U		
1,2,4-Trichlorobenzene	UG/KG	0	0%	3400	0	0	24						
1,2-Dichlorobenzene	UG/KG	0	0%	7900	0	0	24						
1,3-Dichlorobenzene	UG/KG	0	0%	1600	0	0	24						
1,4-Dichlorobenzene	UG/KG	0	0%	8500	0	0	24						
2,2'-oxybis(1-Chloropropane)	UG/KG	0	0%		0	0	27	360 U	370 U	350 U	360 U		
2,4,5-Trichlorophenol	UG/KG	0	0%	100	0	0	69	900 U	940 U	880 U	900 U	5500 U	360 U
2,4,6-Trichlorophenol	UG/KG	0	0%		0	0	69	360 U	370 U	350 U	360 U	5500 U	360 U
2,4-Dichlorophenol	UG/KG	0	0%	400	0	0	69	360 U	370 U	350 U	360 U	5500 U	360 U
2,4-Dimethylphenol	UG/KG	0	0%		0	0	47	360 U	370 U	350 U	360 U		
2,4-Dinitrophenol	UG/KG	0	0%	200	0	0	69	900 U	940 U	880 UJ	900 U	29000 UJ	1900 U
2,4-Dinitrotoluene	UG/KG	880	1%		0	1	69	360 U	370 U	350 U	360 U	5500 U	360 U
2,6-Dinitrotoluene	UG/KG	0	0%	1000	0	0	69	360 U	370 U	350 U	360 U	5500 U	360 U
2-Chloronaphthalene	UG/KG	0	0%		0	0	47	360 U	370 U	350 U	360 U		
2-Chlorophenol	UG/KG	0	0%	800	0	0	69	360 U	370 U	350 U	360 U	5500 U	360 U
2-Methylnaphthalene	UG/KG	19000	22%	36400	0	15	69	360 U	370 U	81 J	360 U	5500 U	360 U
2-Methylphenol	UG/KG	0	0%	100	0	0	69	360 U	370 U	350 U	360 U	5500 U	360 U
2-Nitroaniline	UG/KG	0	0%	430	0	0	69	900 U	940 U	880 U	900 U	29000 U	1900 U
2-Nitrophenol	UG/KG	0	0%	330	0	0	69	360 U	370 U	350 U	360 U	5500 U	360 U
3,3'-Dichlorobenzidine	UG/KG	0	0%		0	0	69	360 U	370 U	350 U	360 U	5500 U	360 U

Table A-4A
SURFACE SOIL SAMPLE RESULTS (0-2 ft.)
SEAD-71
SEAD-59 and SEAD-71 Phase II RI Report
Seneca Army Depot Activity

Facility	SEAD-71	SEAD-71	SEAD-71	SEAD-71	SEAD-71	SEAD-71
Location ID	CL-71-D-F01	CL-71-D-WE1	CL-71-D-WN1	CL-71-D-WS1	CL-71-D-WW3	CL-71-E1-F01
Maxtrix	SOIL	SOIL	SOIL	SOIL	SOIL	SOIL
Sample ID	CL-71-D-F01	CL-71-D-WE1	CL-71-D-WN1	CL-71-D-WS1	CL-71-D-WW3	CL-71-E1-F01
Sample Depth to Top of Sample ⁽¹⁾	0	0	0	0	0	0
Sample Depth to Bottom of Sample ⁽¹⁾	0	0	0	0	0	0
Sample Date	5/6/2004	5/6/2004	5/6/2004	5/6/2004	5/6/2004	5/6/2004
QC Code	SA	SA	SA	SA	SA	SA
Study ID	ENSR IRM	ENSR IRM	ENSR IRM	ENSR IRM	ENSR IRM	ENSR IRM
Sample Round	1	1	1	1	1	1

Parameter	Units	Maximum Frequency of		NYSDEC TAGM 4046 ⁽²⁾	Number of Exceedances	Number of Detects	Number of Analyses	Value (Q)	Value (Q)	Value (Q)	Value (Q)	Value (Q)	Value (Q)
		Value	Detection										
3-Nitroaniline	UG/KG	0	0%	500	0	0	69	900 U	940 U	880 U	900 U	29000 U	1900 U
4,6-Dinitro-2-methylphenol	UG/KG	0	0%		0	0	47	900 U	900 U	880 U	900 U		
4-Bromophenyl phenyl ether	UG/KG	0	0%		0	0	47	360 U	370 U	350 U	360 U		
4-Chloro-3-methylphenol	UG/KG	0	0%	240	0	0	69	360 U	370 U	350 U	360 U	5500 U	360 U
4-Chloroaniline	UG/KG	0	0%	220	0	0	69	360 U	370 U	350 U	360 U	5500 U	360 U
4-Chlorophenyl phenyl ether	UG/KG	0	0%		0	0	47	360 U	370 U	350 U	360 U		
4-Methylphenol	UG/KG	0	0%	900	0	0	69	360 U	370 U	350 U	360 U	5500 U	360 U
4-Nitroaniline	UG/KG	75	2%		0	1	47	900 U	940 U	880 U	900 U		
4-Nitrophenol	UG/KG	0	0%	100	0	0	69	900 U	940 U	880 U	900 U	29000 U	1900 U
Acenaphthene	UG/KG	42000	42%	50000	0	29	69	40 J	80 J	340 J	360 U	5500 U	360 U
Acenaphthylene	UG/KG	1800	28%	41000	0	19	69	33 J	85 J	39 J	360 U	5500 U	360 U
Acetophenone	UG/KG	0	0%		0	0	23	360 U	370 U	350 U	360 U		
Aniline	UG/KG	0	0%		0	0	22					5500 U	360 U
Anthracene	UG/KG	100000	59%	50000	3	41	69	110 J	220 J	640	360 U	5500 U	360 U
Atrazine	UG/KG	0	0%		0	0	23	360 U	370 U	350 U	360 U		
Benzaldehyde	UG/KG	0	0%		0	0	23	360 U	370 U	350 U	360 U		
Benzo(a)anthracene	UG/KG	150000	77%	224	40	53	69	410	500	1300	40 J	1600 J	360 U
Benzo(a)pyrene	UG/KG	120000	77%	61	47	53	69	410	450	1100	51 J	1500 J	360 U
Benzo(b)fluoranthene	UG/KG	88000	78%	1100	23	54	69	540	640	1500	83 J	1300 J	360 U
Benzo(ghi)perylene	UG/KG	62000	70%	50000	1	48	69	230 J	300 J	530	40 J	1000 J	360 U
Benzo(k)fluoranthene	UG/KG	130000	61%	1100	20	42	69	200 J	230 J	560	360 U	1300 J	360 U
Benzoic Acid	UG/KG	0	0%	2700	0	0	22					29000 U	1900 U
Bis(2-Chloroethoxy)methane	UG/KG	0	0%		0	0	47	360 U	370 U	350 U	360 U		
Bis(2-Chloroethyl)ether	UG/KG	0	0%		0	0	47	360 U	370 U	350 U	360 U		
Bis(2-Chloroisopropyl)ether	UG/KG	0	0%		0	0	20						
Bis(2-Ethylhexyl)phthalate	UG/KG	140	9%	50000	0	6	69	360 U	83 J	350 U	360 U	5500 U	360 U
Butylbenzylphthalate	UG/KG	0	0%	50000	0	0	69	360 U	370 U	350 U	360 U	5500 U	360 U
Caprolactam	UG/KG	0	0%		0	0	23	360 U	370 U	350 U	360 U		
Carbazole	UG/KG	77000	57%		0	27	47	53 J	110 J	540	360 U		
Chrysene	UG/KG	150000	81%	400	37	56	69	410 NJ	490	1300	49 J	2000 J	360 U
Di-n-butylphthalate	UG/KG	140	6%	8100	0	4	69	360 U	370 U	350 U	360 U	5500 U	360 U
Di-n-octylphthalate	UG/KG	0	0%	50000	0	0	69	360 U	370 U	350 U	360 U	5500 U	360 U
Dibenz(a,h)anthracene	UG/KG	25000	58%	14	40	40	69	67 J	75 J	160	360 U	5500 U	360 U
Dibenzofuran	UG/KG	38000	39%	6200	4	27	69	23 J	41 J	240 J	360 U	5500 U	360 U
Diethyl phthalate	UG/KG	0	0%	7100	0	0	69	360 U	370 U	350 U	360 U	5500 U	360 U
Dimethylphthalate	UG/KG	0	0%	2000	0	0	69	360 U	370 U	350 U	360 U	5500 U	360 U
Fluoranthene	UG/KG	440000	84%	50000	6	58	69	770	930	3600	82 J	3900 J	360 U
Fluorene	UG/KG	62000	41%	50000	1	28	69	36 J	72 J	350 J	360 U	5500 U	360 U

Table A-4A
SURFACE SOIL SAMPLE RESULTS (0-2 ft.)
SEAD-71
SEAD-59 and SEAD-71 Phase II RI Report
Seneca Army Depot Activity

Facility	SEAD-71	SEAD-71	SEAD-71	SEAD-71	SEAD-71	SEAD-71
Location ID	CL-71-D-F01	CL-71-D-WE1	CL-71-D-WN1	CL-71-D-WS1	CL-71-D-WW3	CL-71-E1-F01
Maxtrix	SOIL	SOIL	SOIL	SOIL	SOIL	SOIL
Sample ID	CL-71-D-F01	CL-71-D-WE1	CL-71-D-WN1	CL-71-D-WS1	CL-71-D-WW3	CL-71-E1-F01
Sample Depth to Top of Sample ⁽¹⁾	0	0	0	0	0	0
Sample Depth to Bottom of Sample ⁽¹⁾	0	0	0	0	0	0
Sample Date	5/6/2004	5/6/2004	5/6/2004	5/6/2004	5/6/2004	5/6/2004
QC Code	SA	SA	SA	SA	SA	SA
Study ID	ENSR IRM	ENSR IRM	ENSR IRM	ENSR IRM	ENSR IRM	ENSR IRM
Sample Round	1	1	1	1	1	1

Parameter	Units	Maximum Frequency of		NYSDEC TAGM 4046 ⁽²⁾	Number of Exceedances	Number of Detects	Number of Analyses	Value (Q)	Value (Q)	Value (Q)	Value (Q)	Value (Q)	Value (Q)
		Value	Detection										
Hexachlorobenzene	UG/KG	0	0%	410	0	0	69	360 U	370 U	350 U	360 U	5500 U	360 U
Hexachlorobutadiene	UG/KG	0	0%		0	0	69	360 U	370 U	350 U	360 U	5500 U	360 U
Hexachlorocyclopentadiene	UG/KG	0	0%		0	0	47	360 U	370 U	350 U	360 U		
Hexachloroethane	UG/KG	0	0%		0	0	69	360 U	370 U	350 U	360 U	5500 U	360 U
Indeno(1,2,3-cd)pyrene	UG/KG	65000	70%	3200	11	48	69	260 J	300 J	630	39 J	970 J	360 U
Isophorone	UG/KG	0	0%	4400	0	0	69	360 U	370 U	350 U	360 U	5500 U	360 U
N-Nitrosodiphenylamine	UG/KG	0	0%		0	0	47	360 U	370 U	350 U	360 U		
N-Nitrosodipropylamine	UG/KG	0	0%		0	0	47	360 U	370 U	350 UJ	360 U		
Naphthalene	UG/KG	46000	22%	13000	1	15	69	360 U	370 U	250 J	360 U	1000 J	360 U
Nitrobenzene	UG/KG	0	0%	200	0	0	69	360 U	370 U	350 U	360 U	5500 U	360 U
Pentachlorophenol	UG/KG	0	0%	1000	0	0	69	900 U	940 U	880 U	900 U	29000 U	1900 U
Phenanthrene	UG/KG	290000	78%	50000	5	54	69	290 J	550	2700	34 J	2100 J	360 U
Phenol	UG/KG	4.5	1%	30	0	1	69	360 U	370 U	350 U	360 U	5500 U	360 U
Pyrene	UG/KG	280000	81%	50000	6	56	69	730	860	2800	77 J	2700 J	360 U
Pyridine	UG/KG	0	0%		0	0	22					29000 U	1900 U
Pesticides/PCBs													
4,4'-DDD	UG/KG	240	26%	2900	0	18	69	3.5 U	4.2	3.5 U	35 U	37 U	22 U
4,4'-DDE	UG/KG	810	42%	2100	0	29	69	9.2 J	29 J	12 NJ	170	37 U	22 U
4,4'-DDT	UG/KG	1300	51%	2100	0	35	69	6.8 NJ	17	7.7 J	54	110	22 U
Aldrin	UG/KG	0	0%	41	0	0	69	1.8 U	1.9 U	1.8 U	18 U	19 U	11 U
Alpha-BHC	UG/KG	18	7%	110	0	5	69	1.8 UJ	1.9 U	1.8 UJ	18 UJ	19 U	11 U
Alpha-Chlordane	UG/KG	2	1%		0	1	69	1.8 U	1.9 U	1.8 U	18 U	19 U	11 U
Beta-BHC	UG/KG	35	9%	200	0	6	69	1.8 U	1.9 U	1.8 U	18 U	19 U	11 U
Delta-BHC	UG/KG	0	0%	300	0	0	69	1.8 U	1.9 U	1.8 U	18 U	19 U	11 U
Dieldrin	UG/KG	3.4	3%	44	0	2	69	3.5 U	3.8 U	3.5 U	35 U	37 U	22 U
Endosulfan I	UG/KG	15	10%	900	0	7	69	1.8 U	1.9 U	1.8 U	18 U	19 U	11 U
Endosulfan II	UG/KG	52	4%	900	0	3	69	3.5 U	3.8 U	3.5 U	35 U	37 U	22 U
Endosulfan sulfate	UG/KG	110	16%	1000	0	11	69	3.5 U	3.8 U	3.5 U	35 U	37 U	22 U
Endrin	UG/KG	120	14%	100	1	10	69	3.5 U	3.8 U	3.5 U	35 U	37 U	22 U
Endrin aldehyde	UG/KG	120	23%		0	16	69	3.5 U	3.8 U	3.5 U	35 U	37 U	22 U
Endrin ketone	UG/KG	180	22%		0	15	69	3.5 U	3.8 U	3.5 U	35 U	37 U	22 U
Gamma-BHC/Lindane	UG/KG	0	0%	60	0	0	69	1.8 U	1.9 U	1.8 U	18 UJ	19 U	11 U
Gamma-Chlordane	UG/KG	48	6%	540	0	4	69	1.8 U	1.9 U	1.8 U	18 U	19 U	11 U
Heptachlor	UG/KG	0	0%	100	0	0	69	1.8 U	1.9 U	1.8 U	18 U	19 U	11 U
Heptachlor epoxide	UG/KG	180	17%	20	4	12	69	1.8 U	1.9 U	1.8 U	18 U	19 U	11 U
Methoxychlor	UG/KG	520	16%		0	11	69	18 U	19 U	18 U	180 U	190 U	110 U
Toxaphene	UG/KG	0	0%		0	0	69	180 U	190 U	180 U	1800 U	370 U	220 U
Aroclor-1016	UG/KG	0	0%		0	0	69	36 U	38 U	36 U	36 U	37 U	36 U

Table A-4A
SURFACE SOIL SAMPLE RESULTS (0-2 ft.)
SEAD-71
SEAD-59 and SEAD-71 Phase II RI Report
Seneca Army Depot Activity

Facility	SEAD-71	SEAD-71	SEAD-71	SEAD-71	SEAD-71	SEAD-71
Location ID	CL-71-D-F01	CL-71-D-WE1	CL-71-D-WN1	CL-71-D-WS1	CL-71-D-WW3	CL-71-E1-F01
Maxtrix	SOIL	SOIL	SOIL	SOIL	SOIL	SOIL
Sample ID	CL-71-D-F01	CL-71-D-WE1	CL-71-D-WN1	CL-71-D-WS1	CL-71-D-WW3	CL-71-E1-F01
Sample Depth to Top of Sample ⁽¹⁾	0	0	0	0	0	0
Sample Depth to Bottom of Sample ⁽¹⁾	0	0	0	0	0	0
Sample Date	5/6/2004	5/6/2004	5/6/2004	5/6/2004	5/6/2004	5/6/2004
QC Code	SA	SA	SA	SA	SA	SA
Study ID	ENSR IRM	ENSR IRM	ENSR IRM	ENSR IRM	ENSR IRM	ENSR IRM
Sample Round	1	1	1	1	1	1

Parameter	Units	Maximum Frequency of		NYSDEC TAGM 4046 ⁽²⁾	Number of Exceedances	Number of Detects	Number of Analyses	Value (Q)	Value (Q)	Value (Q)	Value (Q)	Value (Q)	Value (Q)
		Value	Detection										
Aroclor-1221	UG/KG	0	0%		0	0	69	36 U	38 U	36 U	36 U	37 U	36 U
Aroclor-1232	UG/KG	0	0%		0	0	69	36 U	38 U	36 U	36 U	37 U	36 U
Aroclor-1242	UG/KG	0	0%		0	0	69	36 U	38 U	36 U	36 U	37 U	36 U
Aroclor-1248	UG/KG	0	0%		0	0	69	36 U	38 U	36 U	36 U	37 U	36 U
Aroclor-1254	UG/KG	0	0%	10000	0	0	69	36 U	38 U	36 U	36 U	37 U	36 U
Aroclor-1260	UG/KG	200	4%	10000	0	3	69	36 U	38 U	36 U	36 U	80	36 U
Metals													
Aluminum	MG/KG	18000	100%	19300	0	69	69	10200 J	12900 J	12300 J	11900 J	6680	13800
Antimony	MG/KG	19.3	49%	5.9	5	34	69	1.4 J	2.2 J	2.1 J	1.4 J	6.9	3.3 UJ
Arsenic	MG/KG	14.6	100%	8.2	5	69	69	5.7	6.9	6.9	6.4	4.5	5.7
Barium	MG/KG	179	100%	300	0	69	69	64.4 J	88.9 J	85.7 J	82.6 J	59.9	89.4
Beryllium	MG/KG	0.88	99%	1.1	0	68	69	0.53	0.63	0.65	0.6	0.13	0.51
Cadmium	MG/KG	12.1	67%	2.3	4	46	69	0.24 J	0.28 J	0.37	0.26 J	0.42 J	0.27 U
Calcium	MG/KG	295000	100%	121000	11	69	69	29500	30800	31000	26800	59600	9420
Chromium	MG/KG	60.3	100%	29.6	5	69	69	15.7 J	19.2 J	18.8 J	16.9 J	14.9	20.6
Cobalt	MG/KG	14.6	100%	30	0	69	69	8.9	10.3	10.4	9.7	6.3	12.4
Copper	MG/KG	134	100%	33	21	69	69	22 J	29.4 J	26.9 J	25.6 J	61.4	18.3
Cyanide	MG/KG	0	0%	0.35	0	0	24						
Iron	MG/KG	65100	100%	36500	2	69	69	20100 J	24400 J	23300 J	22500 J	15000	26100
Lead	MG/KG	3470	100%	24.8	33	69	69	14.7 J	48.3 J	42.8 J	17.5 J	568	12.2
Magnesium	MG/KG	59300	100%	21500	6	69	69	8470 J	7320 J	6620 J	8450 J	11800	4370
Manganese	MG/KG	1330	100%	1060	1	69	69	539 J	634 J	563 J	582 J	296	753
Mercury	MG/KG	2.7	80%	0.1	10	55	69	0.07	0.07	0.08	0.04	0.3	0.03
Nickel	MG/KG	110	100%	49	2	69	69	25.1 J	29.2 J	28.1 J	25.6 J	19.4	29.1
Potassium	MG/KG	2180	100%	2380	0	69	69	886	1210	1120	1020	834	961
Selenium	MG/KG	1.8	19%	2	0	13	69	0.37 U	0.41 U	0.38 U	0.38 U	0.54 U	0.55 U
Silver	MG/KG	2.2	39%	0.75	15	27	69	0.73	1.1	0.86	0.96	0.55 U	0.55 U
Sodium	MG/KG	1040	97%	172	19	67	69	76.2	62.5	67.8	65.8	77.9	33.2 J
Thallium	MG/KG	2.3	26%	0.7	10	18	69	0.19 U	0.21 U	0.19 U	0.19 U	0.55 U	0.95 J
Vanadium	MG/KG	29.2	100%	150	0	69	69	15.7 J	19.2 J	20.8 J	18.7 J	15.7	20
Zinc	MG/KG	3660	99%	110	17	68	69	62.8 J	95.4 J	81.6 J	63 J	157 J	75.4

Note(s):

- (1) - Historical sample depths are presented (I.e. prior to 2002 TCRA)
- (2) - NYSDEC Technical and Administrative Guidance Memorandum (TAGM) HWR-94-4046

U = compound was not detected
J = the reported value is an estimated concentration

Table A-4A
SURFACE SOIL SAMPLE RESULTS (0-2 ft.)
SEAD-71
SEAD-59 and SEAD-71 Phase II RI Report
Seneca Army Depot Activity

Facility	SEAD-71	SEAD-71	SEAD-71	SEAD-71	SEAD-71	SEAD-71
Location ID	CL-71-D-F01	CL-71-D-WE1	CL-71-D-WN1	CL-71-D-WS1	CL-71-D-WW3	CL-71-E1-F01
Maxtrix	SOIL	SOIL	SOIL	SOIL	SOIL	SOIL
Sample ID	CL-71-D-F01	CL-71-D-WE1	CL-71-D-WN1	CL-71-D-WS1	CL-71-D-WW3	CL-71-E1-F01
Sample Depth to Top of Sample ⁽¹⁾	0	0	0	0	0	0
Sample Depth to Bottom of Sample ⁽¹⁾	0	0	0	0	0	0
Sample Date	5/6/2004	5/6/2004	5/6/2004	5/6/2004	5/6/2004	5/6/2004
QC Code	SA	SA	SA	SA	SA	SA
Study ID	ENSR IRM	ENSR IRM	ENSR IRM	ENSR IRM	ENSR IRM	ENSR IRM
Sample Round	1	1	1	1	1	1

Parameter	Units	Maximum Value	Frequency of Detection	NYSDEC TAGM 4046 ⁽²⁾	Number of Exceedances	Number of Detects	Number of Analyses	Value (Q)	Value (Q)	Value (Q)	Value (Q)	Value (Q)	Value (Q)

UJ = the compound was not detected; the associated reporting limit is approximate

R = the data was rejected in the data validating process

NJ = compound was "tentatively identified" and the associated numerical value is approximate

Table A-4A
SURFACE SOIL SAMPLE RESULTS (0-2 ft.)
SEAD-71
SEAD-59 and SEAD-71 Phase II RI Report
Seneca Army Depot Activity

Facility	SEAD-71	SEAD-71	SEAD-71	SEAD-71	SEAD-71	SEAD-71
Location ID	CL-71-E1-WE1	CL-71-E1-WN1	CL-71-E1-WS1	CL-71-E1-WW1	CL-71-E2-F01	CL-71-E2-WE1
Maxtrix	SOIL	SOIL	SOIL	SOIL	SOIL	SOIL
Sample ID	CL-71-E1-WE1	CL-71-E1-WN1	CL-71-E1-WS1	CL-71-E1-WW1	CL-71-E2-F01	CL-71-E2-WE1
Sample Depth to Top of Sample ⁽¹⁾	0	0	0	0	0	0
Sample Depth to Bottom of Sample ⁽¹⁾	0	0	0	0	0	0
Sample Date	5/6/2004	5/6/2004	5/6/2004	5/6/2004	5/6/2004	5/6/2004
QC Code	SA	SA	SA	SA	SA	SA
Study ID	ENSR IRM	ENSR IRM	ENSR IRM	ENSR IRM	ENSR IRM	ENSR IRM
Sample Round	1	1	1	1	1	1

Parameter	Units	Maximum Frequency of		NYSDEC TAGM 4046 ⁽²⁾	Number of Exceedances	Number of Detects	Number of Analyses	Value (Q)	Value (Q)	Value (Q)	Value (Q)	Value (Q)	Value (Q)
		Value	Detection										
Volatile Organics													
1,1,1-Trichloroethane	UG/KG	3	3%	800	0	2	68	5.5 U	5 U	5 U	5 U	6 U	6.1 U
1,1,2,2-Tetrachloroethane	UG/KG	0	0%	600	0	0	64	5.5 U	5 UJ	5 R	5 R	6 U	6.1 U
1,1,2-Trichloro-1,2,2-Trifluoroethane	UG/KG	0	0%		0	0	44	5.5 U	5 UJ	5 UJ	5 UJ	6 U	6.1 U
1,1,2-Trichloroethane	UG/KG	0	0%		0	0	47		5 U	5 U	5 U	6 U	
1,1-Dichloroethane	UG/KG	0	0%	200	0	0	68	5.5 U	5 U	5 U	5 U	6 U	6.1 U
1,1-Dichloroethene	UG/KG	0	0%	400	0	0	68	5.5 U	5 U	5 U	5 U	6 U	6.1 U
1,2,3-Trichloropropane	UG/KG	0	0%		0	0	21	5.5 U					6.1 U
1,2,4-Trichlorobenzene	UG/KG	0	0%	3400	0	0	40	5.5 U	5 UJ	5 R	5 R	6 U	6.1 U
1,2-Dibromo-3-chloropropane	UG/KG	0	0%		0	0	19		5 UJ	5 R	5 R	6 U	
1,2-Dibromoethane	UG/KG	0	0%		0	0	23		5 U	5 UJ	5 UJ	6 UJ	
1,2-Dichlorobenzene	UG/KG	0	0%	7900	0	0	40	5.5 U	5 UJ	5 R	5 R	6 U	6.1 U
1,2-Dichloroethane	UG/KG	0	0%	100	0	0	68	5.5 U	5 U	5 U	5 U	6 U	6.1 U
1,2-Dichloroethene (total)	UG/KG	0	0%		0	0	24						
1,2-Dichloropropane	UG/KG	0	0%		0	0	47		5 U	5 U	5 U	6 U	
1,3-Dichlorobenzene	UG/KG	0	0%	1600	0	0	40	5.5 U	5 UJ	5 R	5 R	6 U	6.1 U
1,3-Dichloropropane	UG/KG	0	0%		0	0	21	5.5 U					6.1 U
1,4-Dichlorobenzene	UG/KG	0	0%	8500	0	0	40	5.5 U	5 UJ	5 R	5 R	6 U	6.1 U
Acetone	UG/KG	74	13%	200	0	9	68	22 U	30 J	35 J	37 J	4 NJ	24 UJ
Benzene	UG/KG	2	3%	60	0	2	68	5.5 U	5 U	5 U	5 U	6 U	6.1 U
Bromodichloromethane	UG/KG	0	0%		0	0	47		5 U	5 U	5 U	6 U	
Bromoform	UG/KG	0	0%		0	0	47		5 U	5 UJ	5 UJ	6 UJ	
Carbon disulfide	UG/KG	5	4%	2700	0	3	68	5.5 U	5 U	5 U	5 U	6 U	6.1 U
Carbon tetrachloride	UG/KG	0	0%	600	0	0	68	5.5 U	5 U	5 U	5 U	6 UJ	6.1 U
Chlorobenzene	UG/KG	0	0%	1700	0	0	68	5.5 U	5 U	5 UJ	5 UJ	6 U	6.1 U
Chlorodibromomethane	UG/KG	0	0%		0	0	68	5.5 U	5 U	5 UJ	5 UJ	6 U	6.1 U
Chloroethane	UG/KG	0	0%	1900	0	0	68	11 U	5 U	5 U	5 U	6 U	12 U
Chloroform	UG/KG	0	0%	300	0	0	68	5.5 U	5 U	5 U	5 U	6 U	6.1 U
Cis-1,2-Dichloroethene	UG/KG	0	0%		0	0	23		5 U	5 U	5 U	6 U	
Cis-1,3-Dichloropropene	UG/KG	0	0%		0	0	47		5 U	5 U	5 U	6 U	
Cyclohexane	UG/KG	4	9%		0	2	23		5 U	5 U	5 U	6 U	
Dichlorodifluoromethane	UG/KG	0	0%		0	0	23		5 UJ	5 UJ	5 UJ	6 U	
Ethyl benzene	UG/KG	4	3%	5500	0	2	68	5.5 U	5 U	5 UJ	5 UJ	6 U	6.1 U
Isopropylbenzene	UG/KG	0	0%		0	0	23		5 U	5 UJ	5 UJ	6 U	
Meta/Para Xylene	UG/KG	0	0%		0	0	21	5.5 U					6.1 U
Methyl Acetate	UG/KG	0	0%		0	0	23		5 U	5 U	5 U	6 U	
Methyl Tertbutyl Ether	UG/KG	0	0%		0	0	23		5 U	5 U	5 U	6 U	
Methyl bromide	UG/KG	0	0%		0	0	47		5 U	5 U	5 U	6 U	

Table A-4A
SURFACE SOIL SAMPLE RESULTS (0-2 ft.)
SEAD-71
SEAD-59 and SEAD-71 Phase II RI Report
Seneca Army Depot Activity

Facility	SEAD-71	SEAD-71	SEAD-71	SEAD-71	SEAD-71	SEAD-71
Location ID	CL-71-E1-WE1	CL-71-E1-WN1	CL-71-E1-WS1	CL-71-E1-WW1	CL-71-E2-F01	CL-71-E2-WE1
Maxtrix	SOIL	SOIL	SOIL	SOIL	SOIL	SOIL
Sample ID	CL-71-E1-WE1	CL-71-E1-WN1	CL-71-E1-WS1	CL-71-E1-WW1	CL-71-E2-F01	CL-71-E2-WE1
Sample Depth to Top of Sample ⁽¹⁾	0	0	0	0	0	0
Sample Depth to Bottom of Sample ⁽¹⁾	0	0	0	0	0	0
Sample Date	5/6/2004	5/6/2004	5/6/2004	5/6/2004	5/6/2004	5/6/2004
QC Code	SA	SA	SA	SA	SA	SA
Study ID	ENSR IRM	ENSR IRM	ENSR IRM	ENSR IRM	ENSR IRM	ENSR IRM
Sample Round	1	1	1	1	1	1

Parameter	Units	Maximum Frequency of		NYSDEC TAGM 4046 ⁽²⁾	Number of Exceedances	Number of Detects	Number of Analyses	Value (Q)	Value (Q)	Value (Q)	Value (Q)	Value (Q)	Value (Q)
		Value	Detection										
Methyl butyl ketone	UG/KG	0	0%		0	0	47		5 U	5 UJ	5 UJ	6 UJ	
Methyl chloride	UG/KG	0	0%		0	0	47		5 U	5 U	5 U	6 U	
Methyl cyclohexane	UG/KG	6	13%		0	3	23		5 U	5 U	5 U	6 U	
Methyl ethyl ketone	UG/KG	0	0%	300	0	0	68	11 U	5 U	5 U	5 U	6 UJ	12 U
Methyl isobutyl ketone	UG/KG	0	0%	1000	0	0	68	11 U	5 U	5 U	5 U	6 UJ	12 U
Methylene chloride	UG/KG	11	12%	100	0	8	68	5.5 U	5 U	5 U	6 U	1 J	6.1 U
Ortho Xylene	UG/KG	0	0%		0	0	21	5.5 U					6.1 U
Styrene	UG/KG	1	2%		0	1	47		5 U	5 UJ	5 UJ	6 U	
Tetrachloroethene	UG/KG	33	1%	1400	0	1	68	5.5 U	5 U	5 UJ	5 UJ	6 U	6.1 U
Toluene	UG/KG	16	16%	1500	0	11	68	5.5 U	5 U	5 U	5 U	6 U	6.1 U
Total BTEX	MG/KG	11.6	100%		0	1	1						
Total Xylenes	UG/KG	11	11%	1200	0	5	44		5 UJ	5 R	5 R	6 U	
Trans-1,2-Dichloroethene	UG/KG	0	0%	300	0	0	44	5.5 U	5 U	5 U	5 U	6 U	6.1 U
Trans-1,3-Dichloropropene	UG/KG	0	0%		0	0	47		5 U	5 U	5 U	6 U	
Trichloroethene	UG/KG	0	0%	700	0	0	68	5.5 U	5 U	5 U	5 U	6 U	6.1 U
Trichlorofluoromethane	UG/KG	1	4%		0	1	23		5 UJ	5 UJ	5 UJ	6 UJ	
Vinyl chloride	UG/KG	0	0%	200	0	0	68	11 U	5 U	5 U	5 U	6 U	12 U
Semivolatile Organics													
1,1'-Biphenyl	UG/KG	0	0%		0	0	23		370 U	360 U	340 U	390 U	
1,2,4-Trichlorobenzene	UG/KG	0	0%	3400	0	0	24						
1,2-Dichlorobenzene	UG/KG	0	0%	7900	0	0	24						
1,3-Dichlorobenzene	UG/KG	0	0%	1600	0	0	24						
1,4-Dichlorobenzene	UG/KG	0	0%	8500	0	0	24						
2,2'-oxybis(1-Chloropropane)	UG/KG	0	0%		0	0	27			370 U	360 U	340 U	390 U
2,4,5-Trichlorophenol	UG/KG	0	0%	100	0	0	69	360 U	920 U	900 U	870 U	970 U	2000 U
2,4,6-Trichlorophenol	UG/KG	0	0%		0	0	69	360 U	370 U	360 U	340 U	390 U	2000 U
2,4-Dichlorophenol	UG/KG	0	0%	400	0	0	69	360 U	370 U	360 U	340 U	390 U	2000 U
2,4-Dimethylphenol	UG/KG	0	0%		0	0	47		370 U	360 U	340 U	390 U	
2,4-Dinitrophenol	UG/KG	0	0%	200	0	0	69	1900 U	920 UJ	900 UJ	870 UJ	970 UJ	10000 U
2,4-Dinitrotoluene	UG/KG	880	1%		0	1	69	360 U	370 U	360 U	340 U	390 U	2000 U
2,6-Dinitrotoluene	UG/KG	0	0%	1000	0	0	69	360 U	370 U	360 U	340 U	390 U	2000 U
2-Chloronaphthalene	UG/KG	0	0%		0	0	47		370 U	360 U	340 U	390 U	
2-Chlorophenol	UG/KG	0	0%	800	0	0	69	360 U	370 U	360 U	340 U	390 U	2000 U
2-Methylnaphthalene	UG/KG	19000	22%	36400	0	15	69	360 U	370 U	360 U	340 U	390 U	2000 U
2-Methylphenol	UG/KG	0	0%	100	0	0	69	360 U	370 U	360 U	340 U	390 U	2000 U
2-Nitroaniline	UG/KG	0	0%	430	0	0	69	1900 U	920 U	900 U	870 U	970 U	10000 U
2-Nitrophenol	UG/KG	0	0%	330	0	0	69	360 U	370 U	360 U	340 U	390 U	2000 U
3,3'-Dichlorobenzidine	UG/KG	0	0%		0	0	69	360 U	370 U	360 U	340 U	390 U	2000 U

Table A-4A
SURFACE SOIL SAMPLE RESULTS (0-2 ft.)
SEAD-71
SEAD-59 and SEAD-71 Phase II RI Report
Seneca Army Depot Activity

Facility	SEAD-71	SEAD-71	SEAD-71	SEAD-71	SEAD-71	SEAD-71
Location ID	CL-71-E1-WE1	CL-71-E1-WN1	CL-71-E1-WS1	CL-71-E1-WW1	CL-71-E2-F01	CL-71-E2-WE1
Maxtrix	SOIL	SOIL	SOIL	SOIL	SOIL	SOIL
Sample ID	CL-71-E1-WE1	CL-71-E1-WN1	CL-71-E1-WS1	CL-71-E1-WW1	CL-71-E2-F01	CL-71-E2-WE1
Sample Depth to Top of Sample ⁽¹⁾	0	0	0	0	0	0
Sample Depth to Bottom of Sample ⁽¹⁾	0	0	0	0	0	0
Sample Date	5/6/2004	5/6/2004	5/6/2004	5/6/2004	5/6/2004	5/6/2004
QC Code	SA	SA	SA	SA	SA	SA
Study ID	ENSR IRM	ENSR IRM	ENSR IRM	ENSR IRM	ENSR IRM	ENSR IRM
Sample Round	1	1	1	1	1	1

Parameter	Units	Maximum Frequency of		NYSDEC TAGM 4046 ⁽²⁾	Number of Exceedances	Number of Detects	Number of Analyses	Value (Q)	Value (Q)	Value (Q)	Value (Q)	Value (Q)	Value (Q)
		Value	Detection										
3-Nitroaniline	UG/KG	0	0%	500	0	0	69	1900 U	920 U	900 U	870 U	970 U	10000 U
4,6-Dinitro-2-methylphenol	UG/KG	0	0%		0	0	47		920 UJ	900 UJ	870 UJ	970 U	
4-Bromophenyl phenyl ether	UG/KG	0	0%		0	0	47		370 U	360 U	340 U	390 U	
4-Chloro-3-methylphenol	UG/KG	0	0%	240	0	0	69	360 U	370 U	360 U	340 U	390 U	2000 U
4-Chloroaniline	UG/KG	0	0%	220	0	0	69	360 U	370 U	360 U	340 U	390 UJ	2000 U
4-Chlorophenyl phenyl ether	UG/KG	0	0%		0	0	47		370 U	360 U	340 U	390 U	
4-Methylphenol	UG/KG	0	0%	900	0	0	69	360 U	370 U	360 U	340 U	390 U	2000 U
4-Nitroaniline	UG/KG	75	2%		0	1	47		920 U	900 U	870 U	970 U	
4-Nitrophenol	UG/KG	0	0%	100	0	0	69	1900 U	920 U	900 U	870 U	970 U	10000 U
Acenaphthene	UG/KG	42000	42%	50000	0	29	69	360 U	370 U	360 U	340 U	390 U	420 J
Acenaphthylene	UG/KG	1800	28%	41000	0	19	69	360 U	73 J	360 U	37 J	390 U	1200 J
Acetophenone	UG/KG	0	0%		0	0	23		370 U	360 U	340 U	390 U	
Aniline	UG/KG	0	0%		0	0	22	360 U					2000 U
Anthracene	UG/KG	100000	59%	50000	3	41	69	360 U	45 J	360 U	36 J	94 J	1800 J
Atrazine	UG/KG	0	0%		0	0	23		370 U	360 U	340 U	390 U	
Benzaldehyde	UG/KG	0	0%		0	0	23		370 U	360 U	340 U	390 U	
Benzo(a)anthracene	UG/KG	150000	77%	224	40	53	69	360 U	300 J	130 J	140 J	330 J	9000
Benzo(a)pyrene	UG/KG	120000	77%	61	47	53	69	360 U	390 J	150 J	180 J	250 J	8800
Benzo(b)fluoranthene	UG/KG	88000	78%	1100	23	54	69	360 U	720	310 J	400	380 J	7400
Benzo(ghi)perylene	UG/KG	62000	70%	50000	1	48	69	360 U	260 J	110 J	130 J	110 J	5300
Benzo(k)fluoranthene	UG/KG	130000	61%	1100	20	42	69	360 U	370	170 J	190 J	170 J	8000
Benzoic Acid	UG/KG	0	0%	2700	0	0	22	1900 U					10000 U
Bis(2-Chloroethoxy)methane	UG/KG	0	0%		0	0	47		370 U	360 U	340 U	390 U	
Bis(2-Chloroethyl)ether	UG/KG	0	0%		0	0	47		370 U	360 U	340 U	390 U	
Bis(2-Chloroisopropyl)ether	UG/KG	0	0%		0	0	20						
Bis(2-Ethylhexyl)phthalate	UG/KG	140	9%	50000	0	6	69	360 U	370 U	360 U	340 U	390 U	2000 U
Butylbenzylphthalate	UG/KG	0	0%	50000	0	0	69	360 U	370 U	360 U	340 U	390 U	2000 U
Caprolactam	UG/KG	0	0%		0	0	23		370 U	360 U	340 U	390 U	
Carbazole	UG/KG	77000	57%		0	27	47		370 U	360 U	340 U	77 J	
Chrysene	UG/KG	150000	81%	400	37	56	69	360 U	490 J	240 J	280 J	360 J	10000
Di-n-butylphthalate	UG/KG	140	6%	8100	0	4	69	360 U	370 U	360 U	340 U	390 U	2000 U
Di-n-octylphthalate	UG/KG	0	0%	50000	0	0	69	360 U	370 U	360 U	340 U	390 U	2000 U
Dibenz(a,h)anthracene	UG/KG	25000	58%	14	40	40	69	360 U	65 J	360 U	340 U	390 U	2000 J
Dibenzofuran	UG/KG	38000	39%	6200	4	27	69	360 U	370 U	360 U	340 U	390 U	210 J
Diethyl phthalate	UG/KG	0	0%	7100	0	0	69	360 U	370 U	360 U	340 U	390 U	2000 U
Dimethylphthalate	UG/KG	0	0%	2000	0	0	69	360 U	370 U	360 U	340 U	390 U	2000 U
Fluoranthene	UG/KG	440000	84%	50000	6	58	69	360 U	440	280 J	270 J	690	22000
Fluorene	UG/KG	62000	41%	50000	1	28	69	360 U	370 U	360 U	340 U	390 U	540 J

Table A-4A
SURFACE SOIL SAMPLE RESULTS (0-2 ft.)
SEAD-71
SEAD-59 and SEAD-71 Phase II RI Report
Seneca Army Depot Activity

Facility	SEAD-71	SEAD-71	SEAD-71	SEAD-71	SEAD-71	SEAD-71
Location ID	CL-71-E1-WE1	CL-71-E1-WN1	CL-71-E1-WS1	CL-71-E1-WW1	CL-71-E2-F01	CL-71-E2-WE1
Maxtrix	SOIL	SOIL	SOIL	SOIL	SOIL	SOIL
Sample ID	CL-71-E1-WE1	CL-71-E1-WN1	CL-71-E1-WS1	CL-71-E1-WW1	CL-71-E2-F01	CL-71-E2-WE1
Sample Depth to Top of Sample ⁽¹⁾	0	0	0	0	0	0
Sample Depth to Bottom of Sample ⁽¹⁾	0	0	0	0	0	0
Sample Date	5/6/2004	5/6/2004	5/6/2004	5/6/2004	5/6/2004	5/6/2004
QC Code	SA	SA	SA	SA	SA	SA
Study ID	ENSR IRM	ENSR IRM	ENSR IRM	ENSR IRM	ENSR IRM	ENSR IRM
Sample Round	1	1	1	1	1	1

Parameter	Units	Maximum Frequency of		NYSDEC TAGM 4046 ⁽²⁾	Number of Exceedances	Number of Detects	Number of Analyses	Value (Q)	Value (Q)	Value (Q)	Value (Q)	Value (Q)	Value (Q)
		Value	Detection										
Hexachlorobenzene	UG/KG	0	0%	410	0	0	69	360 U	370 U	360 U	340 U	390 U	2000 U
Hexachlorobutadiene	UG/KG	0	0%		0	0	69	360 U	370 U	360 U	340 U	390 U	2000 U
Hexachlorocyclopentadiene	UG/KG	0	0%		0	0	47		370 U	360 U	340 U	390 U	
Hexachloroethane	UG/KG	0	0%		0	0	69	360 U	370 U	360 U	340 U	390 U	2000 U
Indeno(1,2,3-cd)pyrene	UG/KG	65000	70%	3200	11	48	69	360 U	250 J	100 J	130 J	110 J	5400 J
Isophorone	UG/KG	0	0%	4400	0	0	69	360 U	370 U	360 U	340 U	390 U	2000 U
N-Nitrosodiphenylamine	UG/KG	0	0%		0	0	47		370 U	360 U	340 U	390 U	
N-Nitrosodipropylamine	UG/KG	0	0%		0	0	47		370 U	360 U	340 U	390 U	
Naphthalene	UG/KG	46000	22%	13000	1	15	69	360 U	370 U	360 U	340 U	390 U	2000 U
Nitrobenzene	UG/KG	0	0%	200	0	0	69	360 U	370 U	360 U	340 U	390 U	2000 U
Pentachlorophenol	UG/KG	0	0%	1000	0	0	69	1900 U	920 U	900 U	870 U	970 U	10000 U
Phenanthrene	UG/KG	290000	78%	50000	5	54	69	360 U	60 J	78 J	60 J	400	12000
Phenol	UG/KG	4.5	1%	30	0	1	69	360 U	370 U	360 U	340 U	390 U	2000 U
Pyrene	UG/KG	280000	81%	50000	6	56	69	360 U	440	250 J	250 J	730	17000
Pyridine	UG/KG	0	0%		0	0	22	1900 U					10000 U
Pesticides/PCBs													
4,4'-DDD	UG/KG	240	26%	2900	0	18	69	22 U	4.7 NJ	3.6 U	3.8 J	3.9 J	20 U
4,4'-DDE	UG/KG	810	42%	2100	0	29	69	22 U	3.7 U	3.6 U	3.4 U	8.3 NJ	20 U
4,4'-DDT	UG/KG	1300	51%	2100	0	35	69	22 U	7.2	3.6 U	3.4 U	9 J	20 U
Aldrin	UG/KG	0	0%	41	0	0	69	11 U	1.9 U	1.8 U	1.8 U	2 U	10 U
Alpha-BHC	UG/KG	18	7%	110	0	5	69	11 U	1.9 U	1.8 U	1.8 U	2 U	10 U
Alpha-Chlordane	UG/KG	2	1%		0	1	69	11 U	1.9 U	1.8 U	1.8 U	2 U	10 U
Beta-BHC	UG/KG	35	9%	200	0	6	69	11 U	1.9 U	1.8 U	1.8 U	2 U	10 U
Delta-BHC	UG/KG	0	0%	300	0	0	69	11 U	1.9 U	1.8 U	1.8 U	2 U	10 U
Dieldrin	UG/KG	3.4	3%	44	0	2	69	22 U	3.7 U	3.6 U	3.4 U	3.8 U	20 U
Endosulfan I	UG/KG	15	10%	900	0	7	69	11 U	1.9 U	1.8 U	1.8 U	2 U	10 U
Endosulfan II	UG/KG	52	4%	900	0	3	69	22 U	3.7 U	3.6 U	3.4 U	3.8 U	20 U
Endosulfan sulfate	UG/KG	110	16%	1000	0	11	69	22 U	3.7 U	3.6 U	3.4 U	3.8 U	20 U
Endrin	UG/KG	120	14%	100	1	10	69	22 U	3.7 U	3.6 U	3.4 U	3.8 U	20 U
Endrin aldehyde	UG/KG	120	23%		0	16	69	22 U	3.7 U	3.6 U	3.4 U	3.8 U	20 U
Endrin ketone	UG/KG	180	22%		0	15	69	22 U	3.7 U	3.6 U	3.4 U	3.8 U	20 U
Gamma-BHC/Lindane	UG/KG	0	0%	60	0	0	69	11 U	1.9 U	1.8 U	1.8 U	2 U	10 U
Gamma-Chlordane	UG/KG	48	6%	540	0	4	69	11 U	1.9 U	1.8 U	1.8 U	2 U	10 U
Heptachlor	UG/KG	0	0%	100	0	0	69	11 U	1.9 U	1.8 U	1.8 U	2 U	10 U
Heptachlor epoxide	UG/KG	180	17%	20	4	12	69	11 U	1.9 U	1.8 U	3.2 NJ	2 U	10 U
Methoxychlor	UG/KG	520	16%		0	11	69	110 U	19 U	18 U	18 U	20 U	100 U
Toxaphene	UG/KG	0	0%		0	0	69	220 U	190 U	180 U	180 U	200 U	200 U
Aroclor-1016	UG/KG	0	0%		0	0	69	36 U	37 U	36 U	35 U	39 U	40 U

Table A-4A
SURFACE SOIL SAMPLE RESULTS (0-2 ft.)
SEAD-71
SEAD-59 and SEAD-71 Phase II RI Report
Seneca Army Depot Activity

Facility	SEAD-71	SEAD-71	SEAD-71	SEAD-71	SEAD-71	SEAD-71
Location ID	CL-71-E1-WE1	CL-71-E1-WN1	CL-71-E1-WS1	CL-71-E1-WW1	CL-71-E2-F01	CL-71-E2-WE1
Maxtrix	SOIL	SOIL	SOIL	SOIL	SOIL	SOIL
Sample ID	CL-71-E1-WE1	CL-71-E1-WN1	CL-71-E1-WS1	CL-71-E1-WW1	CL-71-E2-F01	CL-71-E2-WE1
Sample Depth to Top of Sample ⁽¹⁾	0	0	0	0	0	0
Sample Depth to Bottom of Sample ⁽¹⁾	0	0	0	0	0	0
Sample Date	5/6/2004	5/6/2004	5/6/2004	5/6/2004	5/6/2004	5/6/2004
QC Code	SA	SA	SA	SA	SA	SA
Study ID	ENSR IRM	ENSR IRM	ENSR IRM	ENSR IRM	ENSR IRM	ENSR IRM
Sample Round	1	1	1	1	1	1

Parameter	Units	Maximum Frequency of		NYSDEC TAGM 4046 ⁽²⁾	Number of Exceedances	Number of Detects	Number of Analyses	Value (Q)	Value (Q)	Value (Q)	Value (Q)	Value (Q)	Value (Q)
		Value	Detection										
Aroclor-1221	UG/KG	0	0%		0	0	69	36 U	37 U	36 U	35 U	39 U	40 U
Aroclor-1232	UG/KG	0	0%		0	0	69	36 U	37 U	36 U	35 U	39 U	40 U
Aroclor-1242	UG/KG	0	0%		0	0	69	36 U	37 U	36 U	35 U	39 U	40 U
Aroclor-1248	UG/KG	0	0%		0	0	69	36 U	37 U	36 U	35 U	39 U	40 U
Aroclor-1254	UG/KG	0	0%	10000	0	0	69	36 U	37 U	36 U	35 U	39 U	40 U
Aroclor-1260	UG/KG	200	4%	10000	0	3	69	36 U	37 U	36 U	35 U	39 U	40 U
Metals													
Aluminum	MG/KG	18000	100%	19300	0	69	69	13000	14300 J	13200 J	13600 J	12600 J	12900
Antimony	MG/KG	19.3	49%	5.9	5	34	69	3.2 UJ	1.5 J	1.8 J	2.3 J	1.2 J	3.6 UJ
Arsenic	MG/KG	14.6	100%	8.2	5	69	69	5.4	6.7	6.6	6.6	7.1 J	5.2 J
Barium	MG/KG	179	100%	300	0	69	69	85.4	136 J	87.7 J	92.6 J	79.7 J	72.4
Beryllium	MG/KG	0.88	99%	1.1	0	68	69	0.46	0.85	0.69	0.71	0.64	0.36
Cadmium	MG/KG	12.1	67%	2.3	4	46	69	0.27 U	0.36	0.29 J	0.3 J	0.31 J	0.3 U
Calcium	MG/KG	295000	100%	121000	11	69	69	9090	7460 J	7370 J	11500 J	21300 J	22100
Chromium	MG/KG	60.3	100%	29.6	5	69	69	19.1	20.5 J	19.1 J	19.6 J	19.1 J	19.3
Cobalt	MG/KG	14.6	100%	30	0	69	69	11.2	11.1 J	10.4 J	9.3 J	10.3 J	11.1
Copper	MG/KG	134	100%	33	21	69	69	16.2	22.4 J	20.1 J	24.5 J	25.1 J	17.6
Cyanide	MG/KG	0	0%	0.35	0	0	24						
Iron	MG/KG	65100	100%	36500	2	69	69	24000	25300	24300	24000	26000 J	23700 J
Lead	MG/KG	3470	100%	24.8	33	69	69	12.1	18.7 J	16.8 J	25.1 J	28.7 J	11.4
Magnesium	MG/KG	59300	100%	21500	6	69	69	3800	4220 J	3980 J	3890 J	6420 J	4320
Manganese	MG/KG	1330	100%	1060	1	69	69	741	737 J	742 J	679 J	621 J	647
Mercury	MG/KG	2.7	80%	0.1	10	55	69	0.04	0.1	0.06	0.04	0.04 J	0.04 J
Nickel	MG/KG	110	100%	49	2	69	69	25.4	26.7 J	24.5 J	24.3 J	30.8 J	26.4
Potassium	MG/KG	2180	100%	2380	0	69	69	901	1150	815	901	1020 J	859
Selenium	MG/KG	1.8	19%	2	0	13	69	0.54 U	0.44 U	0.4 U	0.4 U	0.47 U	0.6 U
Silver	MG/KG	2.2	39%	0.75	15	27	69	0.54 U	1.8	1.7	1.6	1 J	0.6 U
Sodium	MG/KG	1040	97%	172	19	67	69	35.6 J	53.9	46.4	51.6	51.1	43.8 J
Thallium	MG/KG	2.3	26%	0.7	10	18	69	1.1 J	0.22 U	0.2 U	0.2 U	0.23 U	0.64 J
Vanadium	MG/KG	29.2	100%	150	0	69	69	19.8	20.6 J	19.1 J	20 J	18.9 J	19.3
Zinc	MG/KG	3660	99%	110	17	68	69	66	76.3	69.2	83.1	73.4 J	68.6 J

Note(s):

- (1) - Historical sample depths are presented (I.e. prior to 2002 TCRA)
- (2) - NYSDEC Technical and Administrative Guidance Memorandum (TAGM) HWR-94-4046

U = compound was not detected
J = the reported value is an estimated concentration

Table A-4A
SURFACE SOIL SAMPLE RESULTS (0-2 ft.)
SEAD-71
SEAD-59 and SEAD-71 Phase II RI Report
Seneca Army Depot Activity

Facility	SEAD-71	SEAD-71	SEAD-71	SEAD-71	SEAD-71	SEAD-71
Location ID	CL-71-E1-WE1	CL-71-E1-WN1	CL-71-E1-WS1	CL-71-E1-WW1	CL-71-E2-F01	CL-71-E2-WE1
Maxtrix	SOIL	SOIL	SOIL	SOIL	SOIL	SOIL
Sample ID	CL-71-E1-WE1	CL-71-E1-WN1	CL-71-E1-WS1	CL-71-E1-WW1	CL-71-E2-F01	CL-71-E2-WE1
Sample Depth to Top of Sample ⁽¹⁾	0	0	0	0	0	0
Sample Depth to Bottom of Sample ⁽¹⁾	0	0	0	0	0	0
Sample Date	5/6/2004	5/6/2004	5/6/2004	5/6/2004	5/6/2004	5/6/2004
QC Code	SA	SA	SA	SA	SA	SA
Study ID	ENSR IRM	ENSR IRM	ENSR IRM	ENSR IRM	ENSR IRM	ENSR IRM
Sample Round	1	1	1	1	1	1

Parameter	Units	Maximum Value	Frequency of Detection	NYSDEC TAGM 4046 ⁽²⁾	Number of Exceedances	Number of Detects	Number of Analyses	Value (Q)	Value (Q)	Value (Q)	Value (Q)	Value (Q)	Value (Q)

UJ = the compound was not detected; the associated reporting limit is approximate

R = the data was rejected in the data validating process

NJ = compound was "tentatively identified" and the associated numerical value is approximate

Table A-4A
SURFACE SOIL SAMPLE RESULTS (0-2 ft.)
SEAD-71
SEAD-59 and SEAD-71 Phase II RI Report
Seneca Army Depot Activity

Facility	SEAD-71	SEAD-71	SEAD-71	SEAD-71	SEAD-71	SEAD-71
Location ID	CL-71-E2-WN1	CL-71-E2-WS1	CL-71-E2-WW1	CL-71-E3-F01	CL-71-E3-WE1	CL-71-E3-WN1
Maxtrix	SOIL	SOIL	SOIL	SOIL	SOIL	SOIL
Sample ID	CL-71-E2-WN1	CL-71-E2-WS1	CL-71-E2-WW1	CL-71-E3-F01	CL-71-E3-WE1	CL-71-E3-WN1
Sample Depth to Top of Sample ⁽¹⁾	0	0	0	0	0	0
Sample Depth to Bottom of Sample ⁽¹⁾	0	0	0	0	0	0
Sample Date	5/6/2004	5/6/2004	5/6/2004	5/6/2004	5/6/2004	5/6/2004
QC Code	SA	SA	SA	SA	SA	SA
Study ID	ENSR IRM	ENSR IRM	ENSR IRM	ENSR IRM	ENSR IRM	ENSR IRM
Sample Round	1	1	1	1	1	1

Parameter	Units	Maximum Frequency of		NYSDEC TAGM 4046 ⁽²⁾	Number of Exceedances	Number of Detects	Number of Analyses	Value (Q)	Value (Q)	Value (Q)	Value (Q)	Value (Q)	Value (Q)
		Value	Detection										
Volatile Organics													
1,1,1-Trichloroethane	UG/KG	3	3%	800	0	2	68	6 U	5.8 U	6 U	6 U	5.7 U	5.8 U
1,1,2,2-Tetrachloroethane	UG/KG	0	0%	600	0	0	64	6 U	5.8 U	6 U	6 U	5.7 U	5.8 U
1,1,2-Trichloro-1,2,2-Trifluoroethane	UG/KG	0	0%		0	0	44	6 UJ	5.8 U	6 U	6 U	5.7 U	5.8 U
1,1,2-Trichloroethane	UG/KG	0	0%		0	0	47	6 U					
1,1-Dichloroethane	UG/KG	0	0%	200	0	0	68	6 U	5.8 U	6 U	6 U	5.7 U	5.8 U
1,1-Dichloroethene	UG/KG	0	0%	400	0	0	68	6 U	5.8 U	6 U	6 U	5.7 U	5.8 U
1,2,3-Trichloropropane	UG/KG	0	0%		0	0	21		5.8 U	6 U	6 U	5.7 U	5.8 U
1,2,4-Trichlorobenzene	UG/KG	0	0%	3400	0	0	40	6 U	5.8 U	6 U	6 U	5.7 U	5.8 U
1,2-Dibromo-3-chloropropane	UG/KG	0	0%		0	0	19	6 U					
1,2-Dibromoethane	UG/KG	0	0%		0	0	23	6 U					
1,2-Dichlorobenzene	UG/KG	0	0%	7900	0	0	40	6 U	5.8 U	6 U	6 U	5.7 U	5.8 U
1,2-Dichloroethane	UG/KG	0	0%	100	0	0	68	6 U	5.8 U	6 U	6 U	5.7 U	5.8 U
1,2-Dichloroethene (total)	UG/KG	0	0%		0	0	24						
1,2-Dichloropropane	UG/KG	0	0%		0	0	47	6 U					
1,3-Dichlorobenzene	UG/KG	0	0%	1600	0	0	40	6 U	5.8 U	6 U	6 U	5.7 U	5.8 U
1,3-Dichloropropane	UG/KG	0	0%		0	0	21		5.8 U	6 U	6 U	5.7 U	5.8 U
1,4-Dichlorobenzene	UG/KG	0	0%	8500	0	0	40	6 U	5.8 U	6 U	6 U	5.7 U	5.8 U
Acetone	UG/KG	74	13%	200	0	9	68	6 U	23 UJ	24 UJ	24 UJ	23 UJ	23 UJ
Benzene	UG/KG	2	3%	60	0	2	68	6 U	5.8 U	6 U	6 U	5.7 U	5.8 U
Bromodichloromethane	UG/KG	0	0%		0	0	47	6 U					
Bromoform	UG/KG	0	0%		0	0	47	6 U					
Carbon disulfide	UG/KG	5	4%	2700	0	3	68	6 U	5.8 U	6 U	6 U	5.7 U	5.8 U
Carbon tetrachloride	UG/KG	0	0%	600	0	0	68	6 U	5.8 U	6 U	6 U	5.7 U	5.8 U
Chlorobenzene	UG/KG	0	0%	1700	0	0	68	6 U	5.8 U	6 U	6 U	5.7 U	5.8 U
Chlorodibromomethane	UG/KG	0	0%		0	0	68	6 U	5.8 U	6 U	6 U	5.7 U	5.8 U
Chloroethane	UG/KG	0	0%	1900	0	0	68	6 U	12 U	12 U	12 U	11 U	12 U
Chloroform	UG/KG	0	0%	300	0	0	68	6 U	5.8 U	6 U	6 U	5.7 U	5.8 U
Cis-1,2-Dichloroethene	UG/KG	0	0%		0	0	23	6 U					
Cis-1,3-Dichloropropene	UG/KG	0	0%		0	0	47	6 U					
Cyclohexane	UG/KG	4	9%		0	2	23	6 U					
Dichlorodifluoromethane	UG/KG	0	0%		0	0	23	6 U					
Ethyl benzene	UG/KG	4	3%	5500	0	2	68	6 U	5.8 U	6 U	6 U	5.7 U	5.8 U
Isopropylbenzene	UG/KG	0	0%		0	0	23	6 U					
Meta/Para Xylene	UG/KG	0	0%		0	0	21		5.8 U	6 U	6 U	5.7 U	5.8 U
Methyl Acetate	UG/KG	0	0%		0	0	23	6 U					
Methyl Tertbutyl Ether	UG/KG	0	0%		0	0	23	6 U					
Methyl bromide	UG/KG	0	0%		0	0	47	6 UJ					

Table A-4A
SURFACE SOIL SAMPLE RESULTS (0-2 ft.)
SEAD-71
SEAD-59 and SEAD-71 Phase II RI Report
Seneca Army Depot Activity

Facility	SEAD-71	SEAD-71	SEAD-71	SEAD-71	SEAD-71	SEAD-71
Location ID	CL-71-E2-WN1	CL-71-E2-WS1	CL-71-E2-WW1	CL-71-E3-F01	CL-71-E3-WE1	CL-71-E3-WN1
Maxtrix	SOIL	SOIL	SOIL	SOIL	SOIL	SOIL
Sample ID	CL-71-E2-WN1	CL-71-E2-WS1	CL-71-E2-WW1	CL-71-E3-F01	CL-71-E3-WE1	CL-71-E3-WN1
Sample Depth to Top of Sample ⁽¹⁾	0	0	0	0	0	0
Sample Depth to Bottom of Sample ⁽¹⁾	0	0	0	0	0	0
Sample Date	5/6/2004	5/6/2004	5/6/2004	5/6/2004	5/6/2004	5/6/2004
QC Code	SA	SA	SA	SA	SA	SA
Study ID	ENSR IRM	ENSR IRM	ENSR IRM	ENSR IRM	ENSR IRM	ENSR IRM
Sample Round	1	1	1	1	1	1

Parameter	Units	Maximum Frequency of		NYSDEC TAGM 4046 ⁽²⁾	Number of Exceedances	Number of Detects	Number of Analyses	Value (Q)	Value (Q)	Value (Q)	Value (Q)	Value (Q)	Value (Q)
		Value	Detection										
Methyl butyl ketone	UG/KG	0	0%		0	0	47	6 U					
Methyl chloride	UG/KG	0	0%		0	0	47	6 U					
Methyl cyclohexane	UG/KG	6	13%		0	3	23	6 U					
Methyl ethyl ketone	UG/KG	0	0%	300	0	0	68	6 U	12 U	12 U	12 U	11 U	12 U
Methyl isobutyl ketone	UG/KG	0	0%	1000	0	0	68	6 U	12 U	12 U	12 U	11 U	12 U
Methylene chloride	UG/KG	11	12%	100	0	8	68	6 U	5.8 U	6 U	6 U	5.7 U	5.8 U
Ortho Xylene	UG/KG	0	0%		0	0	21		5.8 U	6 U	6 U	5.7 U	5.8 U
Styrene	UG/KG	1	2%		0	1	47	6 U					
Tetrachloroethene	UG/KG	33	1%	1400	0	1	68	6 U	5.8 U	6 U	6 U	5.7 U	5.8 U
Toluene	UG/KG	16	16%	1500	0	11	68	6 U	5.8 U	6 U	6 U	5.7 U	5.8 U
Total BTEX	MG/KG	11.6	100%		0	1	1						
Total Xylenes	UG/KG	11	11%	1200	0	5	44	6 U					
Trans-1,2-Dichloroethene	UG/KG	0	0%	300	0	0	44	6 U	5.8 U	6 U	6 U	5.7 U	5.8 U
Trans-1,3-Dichloropropene	UG/KG	0	0%		0	0	47	6 U					
Trichloroethene	UG/KG	0	0%	700	0	0	68	6 U	5.8 U	6 U	6 U	5.7 U	5.8 U
Trichlorofluoromethane	UG/KG	1	4%		0	1	23	6 UJ					
Vinyl chloride	UG/KG	0	0%	200	0	0	68	6 U	12 U	12 U	12 U	11 U	12 U
Semivolatile Organics													
1,1'-Biphenyl	UG/KG	0	0%		0	0	23	400 U					
1,2,4-Trichlorobenzene	UG/KG	0	0%	3400	0	0	24						
1,2-Dichlorobenzene	UG/KG	0	0%	7900	0	0	24						
1,3-Dichlorobenzene	UG/KG	0	0%	1600	0	0	24						
1,4-Dichlorobenzene	UG/KG	0	0%	8500	0	0	24						
2,2'-oxybis(1-Chloropropane)	UG/KG	0	0%		0	0	27	400 U					
2,4,5-Trichlorophenol	UG/KG	0	0%	100	0	0	69	1000 U	1900 U	390 U	390 U	370 U	380 U
2,4,6-Trichlorophenol	UG/KG	0	0%		0	0	69	400 U	1900 U	390 U	390 U	370 U	380 U
2,4-Dichlorophenol	UG/KG	0	0%	400	0	0	69	400 U	1900 U	390 U	390 U	370 U	380 U
2,4-Dimethylphenol	UG/KG	0	0%		0	0	47	400 U					
2,4-Dinitrophenol	UG/KG	0	0%	200	0	0	69	1000 UJ	9900 U	2000 U	2000 UJ	1900 UJ	2000 UJ
2,4-Dinitrotoluene	UG/KG	880	1%		0	1	69	400 U	1900 U	390 U	390 U	370 U	380 U
2,6-Dinitrotoluene	UG/KG	0	0%	1000	0	0	69	400 U	1900 U	390 U	390 U	370 U	380 U
2-Chloronaphthalene	UG/KG	0	0%		0	0	47	400 U					
2-Chlorophenol	UG/KG	0	0%	800	0	0	69	400 U	1900 U	390 U	390 U	370 U	380 U
2-Methylnaphthalene	UG/KG	19000	22%	36400	0	15	69	400 U	1900 U	390 U	390 U	370 U	380 U
2-Methylphenol	UG/KG	0	0%	100	0	0	69	400 U	1900 U	390 U	390 U	370 U	380 U
2-Nitroaniline	UG/KG	0	0%	430	0	0	69	1000 U	9900 U	2000 U	2000 U	1900 U	2000 U
2-Nitrophenol	UG/KG	0	0%	330	0	0	69	400 U	1900 U	390 U	390 U	370 U	380 U
3,3'-Dichlorobenzidine	UG/KG	0	0%		0	0	69	400 U	1900 U	390 U	390 U	370 U	380 U

Table A-4A
SURFACE SOIL SAMPLE RESULTS (0-2 ft.)
SEAD-71
SEAD-59 and SEAD-71 Phase II RI Report
Seneca Army Depot Activity

Facility	SEAD-71	SEAD-71	SEAD-71	SEAD-71	SEAD-71	SEAD-71
Location ID	CL-71-E2-WN1	CL-71-E2-WS1	CL-71-E2-WW1	CL-71-E3-F01	CL-71-E3-WE1	CL-71-E3-WN1
Maxtrix	SOIL	SOIL	SOIL	SOIL	SOIL	SOIL
Sample ID	CL-71-E2-WN1	CL-71-E2-WS1	CL-71-E2-WW1	CL-71-E3-F01	CL-71-E3-WE1	CL-71-E3-WN1
Sample Depth to Top of Sample ⁽¹⁾	0	0	0	0	0	0
Sample Depth to Bottom of Sample ⁽¹⁾	0	0	0	0	0	0
Sample Date	5/6/2004	5/6/2004	5/6/2004	5/6/2004	5/6/2004	5/6/2004
QC Code	SA	SA	SA	SA	SA	SA
Study ID	ENSR IRM	ENSR IRM	ENSR IRM	ENSR IRM	ENSR IRM	ENSR IRM
Sample Round	1	1	1	1	1	1

Parameter	Units	Maximum Frequency of		NYSDEC TAGM 4046 ⁽²⁾	Number of Exceedances	Number of Detects	Number of Analyses	Value (Q)	Value (Q)	Value (Q)	Value (Q)	Value (Q)	Value (Q)
		Value	Detection										
3-Nitroaniline	UG/KG	0	0%	500	0	0	69	1000 U	9900 U	2000 U	2000 U	1900 U	2000 U
4,6-Dinitro-2-methylphenol	UG/KG	0	0%		0	0	47	1000 U					
4-Bromophenyl phenyl ether	UG/KG	0	0%		0	0	47	400 U					
4-Chloro-3-methylphenol	UG/KG	0	0%	240	0	0	69	400 U	1900 U	390 U	390 U	370 U	380 U
4-Chloroaniline	UG/KG	0	0%	220	0	0	69	400 UJ	1900 U	390 U	390 U	370 U	380 U
4-Chlorophenyl phenyl ether	UG/KG	0	0%		0	0	47	400 U					
4-Methylphenol	UG/KG	0	0%	900	0	0	69	400 U	1900 U	390 U	390 U	370 U	380 U
4-Nitroaniline	UG/KG	75	2%		0	1	47	1000 U					
4-Nitrophenol	UG/KG	0	0%	100	0	0	69	1000 U	9900 U	2000 U	2000 U	1900 U	2000 U
Acenaphthene	UG/KG	42000	42%	50000	0	29	69	400 U	1400 J	390 U	390 U	370 U	380 U
Acenaphthylene	UG/KG	1800	28%	41000	0	19	69	400 U	1900 U	390 U	390 U	370 U	380 U
Acetophenone	UG/KG	0	0%		0	0	23	400 U					
Aniline	UG/KG	0	0%		0	0	22		1900 U	390 U	390 U	370 U	380 U
Anthracene	UG/KG	100000	59%	50000	3	41	69	400 U	3900	390 U	390 U	370 U	380 U
Atrazine	UG/KG	0	0%		0	0	23	400 U					
Benzaldehyde	UG/KG	0	0%		0	0	23	400 U					
Benzo(a)anthracene	UG/KG	150000	77%	224	40	53	69	400 U	9100	390 U	390 U	370 U	380 U
Benzo(a)pyrene	UG/KG	120000	77%	61	47	53	69	400 U	6100	390 U	390 U	370 U	380 U
Benzo(b)fluoranthene	UG/KG	88000	78%	1100	23	54	69	400 U	5000	390 U	390 U	370 U	380 U
Benzo(ghi)perylene	UG/KG	62000	70%	50000	1	48	69	400 U	3300	390 U	390 U	370 U	380 U
Benzo(k)fluoranthene	UG/KG	130000	61%	1100	20	42	69	400 U	5500	390 U	390 U	370 U	380 U
Benzoic Acid	UG/KG	0	0%	2700	0	0	22		9900 U	2000 U	2000 UJ	1900 UJ	2000 UJ
Bis(2-Chloroethoxy)methane	UG/KG	0	0%		0	0	47	400 U					
Bis(2-Chloroethyl)ether	UG/KG	0	0%		0	0	47	400 U					
Bis(2-Chloroisopropyl)ether	UG/KG	0	0%		0	0	20						
Bis(2-Ethylhexyl)phthalate	UG/KG	140	9%	50000	0	6	69	400 U	1900 U	390 U	390 U	370 U	39 J
Butylbenzylphthalate	UG/KG	0	0%	50000	0	0	69	400 U	1900 U	390 U	390 U	370 U	380 U
Caprolactam	UG/KG	0	0%		0	0	23	400 U					
Carbazole	UG/KG	77000	57%		0	27	47	400 U					
Chrysene	UG/KG	150000	81%	400	37	56	69	400 U	8800 J	390 U	390 U	370 U	380 U
Di-n-butylphthalate	UG/KG	140	6%	8100	0	4	69	400 U	1900 U	390 U	390 U	370 U	380 U
Di-n-octylphthalate	UG/KG	0	0%	50000	0	0	69	400 U	1900 U	390 U	390 U	370 U	380 U
Dibenz(a,h)anthracene	UG/KG	25000	58%	14	40	40	69	400 U	1400 J	390 U	390 U	370 U	380 U
Dibenzofuran	UG/KG	38000	39%	6200	4	27	69	400 U	260 J	390 U	390 U	370 U	380 U
Diethyl phthalate	UG/KG	0	0%	7100	0	0	69	400 U	1900 U	390 U	390 U	370 U	380 U
Dimethylphthalate	UG/KG	0	0%	2000	0	0	69	400 U	1900 U	390 U	390 U	370 U	380 U
Fluoranthene	UG/KG	440000	84%	50000	6	58	69	400 U	22000	390 U	390 U	370 U	380 U
Fluorene	UG/KG	62000	41%	50000	1	28	69	400 U	770 J	390 U	390 U	370 U	380 U

Table A-4A
SURFACE SOIL SAMPLE RESULTS (0-2 ft.)
SEAD-71
SEAD-59 and SEAD-71 Phase II RI Report
Seneca Army Depot Activity

Facility	SEAD-71	SEAD-71	SEAD-71	SEAD-71	SEAD-71	SEAD-71
Location ID	CL-71-E2-WN1	CL-71-E2-WS1	CL-71-E2-WW1	CL-71-E3-F01	CL-71-E3-WE1	CL-71-E3-WN1
Maxtrix	SOIL	SOIL	SOIL	SOIL	SOIL	SOIL
Sample ID	CL-71-E2-WN1	CL-71-E2-WS1	CL-71-E2-WW1	CL-71-E3-F01	CL-71-E3-WE1	CL-71-E3-WN1
Sample Depth to Top of Sample ⁽¹⁾	0	0	0	0	0	0
Sample Depth to Bottom of Sample ⁽¹⁾	0	0	0	0	0	0
Sample Date	5/6/2004	5/6/2004	5/6/2004	5/6/2004	5/6/2004	5/6/2004
QC Code	SA	SA	SA	SA	SA	SA
Study ID	ENSR IRM	ENSR IRM	ENSR IRM	ENSR IRM	ENSR IRM	ENSR IRM
Sample Round	1	1	1	1	1	1

Parameter	Units	Maximum Frequency of		NYSDEC TAGM 4046 ⁽²⁾	Number of Exceedances	Number of Detects	Number of Analyses	Value (Q)	Value (Q)	Value (Q)	Value (Q)	Value (Q)	Value (Q)
		Value	Detection										
Hexachlorobenzene	UG/KG	0	0%	410	0	0	69	400 U	1900 U	390 U	390 U	370 U	380 U
Hexachlorobutadiene	UG/KG	0	0%		0	0	69	400 U	1900 U	390 U	390 U	370 U	380 U
Hexachlorocyclopentadiene	UG/KG	0	0%		0	0	47	400 U					
Hexachloroethane	UG/KG	0	0%		0	0	69	400 U	1900 U	390 U	390 U	370 U	380 U
Indeno(1,2,3-cd)pyrene	UG/KG	65000	70%	3200	11	48	69	400 U	3300 J	390 U	390 U	370 U	380 U
Isophorone	UG/KG	0	0%	4400	0	0	69	400 U	1900 U	390 U	390 U	370 U	380 U
N-Nitrosodiphenylamine	UG/KG	0	0%		0	0	47	400 U					
N-Nitrosodipropylamine	UG/KG	0	0%		0	0	47	400 U					
Naphthalene	UG/KG	46000	22%	13000	1	15	69	400 U	1900 U	390 U	390 U	370 U	380 U
Nitrobenzene	UG/KG	0	0%	200	0	0	69	400 U	1900 U	390 U	390 U	370 U	380 U
Pentachlorophenol	UG/KG	0	0%	1000	0	0	69	1000 U	9900 U	2000 U	2000 U	1900 U	2000 U
Phenanthrene	UG/KG	290000	78%	50000	5	54	69	400 U	15000	390 U	390 U	370 U	380 U
Phenol	UG/KG	4.5	1%	30	0	1	69	400 U	1900 U	390 U	390 U	370 U	380 U
Pyrene	UG/KG	280000	81%	50000	6	56	69	400 U	17000	390 U	390 U	370 U	380 U
Pyridine	UG/KG	0	0%		0	0	22		9900 U	2000 U	2000 U	1900 U	2000 U
Pesticides/PCBs													
4,4'-DDD	UG/KG	240	26%	2900	0	18	69	4 U	19 U	20 U	20 U	19 U	19 U
4,4'-DDE	UG/KG	810	42%	2100	0	29	69	4 U	19 U	20 U	20 U	19 U	19 U
4,4'-DDT	UG/KG	1300	51%	2100	0	35	69	4 U	19 U	120	20 U	19 U	19 U
Aldrin	UG/KG	0	0%	41	0	0	69	2 U	10 U	10 U	10 U	9.6 U	9.8 U
Alpha-BHC	UG/KG	18	7%	110	0	5	69	2 U	10 U	10 U	10 U	9.6 U	9.8 U
Alpha-Chlordane	UG/KG	2	1%		0	1	69	2 U	10 U	10 U	10 U	9.6 U	9.8 U
Beta-BHC	UG/KG	35	9%	200	0	6	69	2 U	10 U	10 U	10 U	9.6 U	9.8 U
Delta-BHC	UG/KG	0	0%	300	0	0	69	2 U	10 U	10 U	10 U	9.6 U	9.8 U
Dieldrin	UG/KG	3.4	3%	44	0	2	69	4 U	19 U	20 U	20 U	19 U	19 U
Endosulfan I	UG/KG	15	10%	900	0	7	69	2 U	10 U	10 U	10 U	9.6 U	9.8 U
Endosulfan II	UG/KG	52	4%	900	0	3	69	4 U	19 U	20 U	20 U	19 U	19 U
Endosulfan sulfate	UG/KG	110	16%	1000	0	11	69	4 U	19 U	20 U	20 U	19 U	19 U
Endrin	UG/KG	120	14%	100	1	10	69	4 U	19 U	20 U	20 U	19 U	19 U
Endrin aldehyde	UG/KG	120	23%		0	16	69	4 U	19 U	20 U	20 U	19 U	19 U
Endrin ketone	UG/KG	180	22%		0	15	69	4 U	19 U	20 U	20 U	19 U	19 U
Gamma-BHC/Lindane	UG/KG	0	0%	60	0	0	69	2 U	10 U	10 U	10 U	9.6 U	9.8 U
Gamma-Chlordane	UG/KG	48	6%	540	0	4	69	2 U	10 U	10 U	10 U	9.6 U	9.8 U
Heptachlor	UG/KG	0	0%	100	0	0	69	2 U	10 U	10 U	10 U	9.6 U	9.8 U
Heptachlor epoxide	UG/KG	180	17%	20	4	12	69	2 U	10 U	10 U	10 U	9.6 U	9.8 U
Methoxychlor	UG/KG	520	16%		0	11	69	20 U	99 U	100 U	100 U	96 U	98 U
Toxaphene	UG/KG	0	0%		0	0	69	200 U	190 U	200 U	200 U	190 U	190 U
Aroclor-1016	UG/KG	0	0%		0	0	69	40 U	39 U	39 U	39 U	37 U	38 U

Table A-4A
SURFACE SOIL SAMPLE RESULTS (0-2 ft.)
SEAD-71
SEAD-59 and SEAD-71 Phase II RI Report
Seneca Army Depot Activity

Facility	SEAD-71	SEAD-71	SEAD-71	SEAD-71	SEAD-71	SEAD-71
Location ID	CL-71-E2-WN1	CL-71-E2-WS1	CL-71-E2-WW1	CL-71-E3-F01	CL-71-E3-WE1	CL-71-E3-WN1
Maxtrix	SOIL	SOIL	SOIL	SOIL	SOIL	SOIL
Sample ID	CL-71-E2-WN1	CL-71-E2-WS1	CL-71-E2-WW1	CL-71-E3-F01	CL-71-E3-WE1	CL-71-E3-WN1
Sample Depth to Top of Sample ⁽¹⁾	0	0	0	0	0	0
Sample Depth to Bottom of Sample ⁽¹⁾	0	0	0	0	0	0
Sample Date	5/6/2004	5/6/2004	5/6/2004	5/6/2004	5/6/2004	5/6/2004
QC Code	SA	SA	SA	SA	SA	SA
Study ID	ENSR IRM	ENSR IRM	ENSR IRM	ENSR IRM	ENSR IRM	ENSR IRM
Sample Round	1	1	1	1	1	1

Parameter	Units	Maximum Frequency of		NYSDEC TAGM 4046 ⁽²⁾	Number of Exceedances	Number of Detects	Number of Analyses	Value (Q)	Value (Q)	Value (Q)	Value (Q)	Value (Q)	Value (Q)
		Value	Detection										
Aroclor-1221	UG/KG	0	0%		0	0	69	40 U	39 U	39 U	39 U	37 U	38 U
Aroclor-1232	UG/KG	0	0%		0	0	69	40 U	39 U	39 U	39 U	37 U	38 U
Aroclor-1242	UG/KG	0	0%		0	0	69	40 U	39 U	39 U	39 U	37 U	38 U
Aroclor-1248	UG/KG	0	0%		0	0	69	40 U	39 U	39 U	39 U	37 U	38 U
Aroclor-1254	UG/KG	0	0%	10000	0	0	69	40 U	39 U	39 U	39 U	37 U	38 U
Aroclor-1260	UG/KG	200	4%	10000	0	3	69	40 U	39 U	39 U	39 U	37 U	38 U
Metals													
Aluminum	MG/KG	18000	100%	19300	0	69	69	13900 J	11500	10900	14200	11400	15000
Antimony	MG/KG	19.3	49%	5.9	5	34	69	1.8 J	3.3 UJ	3.4 UJ	3.5 UJ	3.4 UJ	3.5 UJ
Arsenic	MG/KG	14.6	100%	8.2	5	69	69	7.5 J	4.7 J	5.2 J	4.9 J	4.5 J	5 J
Barium	MG/KG	179	100%	300	0	69	69	71.7 J	66	94.8	90.6	82.9	85.2
Beryllium	MG/KG	0.88	99%	1.1	0	68	69	0.64	0.36	0.34	0.35	0.21	0.41
Cadmium	MG/KG	12.1	67%	2.3	4	46	69	0.27 J	0.28 U	0.33	0.53 J	0.55 J	0.55 J
Calcium	MG/KG	295000	100%	121000	11	69	69	11000 J	32800	32400	6040 J	34500 J	6060 J
Chromium	MG/KG	60.3	100%	29.6	5	69	69	19.3 J	20.4	18.7	19.8	16.3	22.2
Cobalt	MG/KG	14.6	100%	30	0	69	69	11.9 J	10.9	8.8	10.4	8.6	9.7
Copper	MG/KG	134	100%	33	21	69	69	19.4 J	38.9	23.3	19.1	20.7	20.3
Cyanide	MG/KG	0	0%	0.35	0	0	24						
Iron	MG/KG	65100	100%	36500	2	69	69	27200 J	23100 J	20300 J	26100	22000	29700
Lead	MG/KG	3470	100%	24.8	33	69	69	10.9 J	363	99.2	12.1	12.9	13
Magnesium	MG/KG	59300	100%	21500	6	69	69	4550 J	8350	8730	4730	11100	4520
Manganese	MG/KG	1330	100%	1060	1	69	69	771 J	453	503	849	555	470
Mercury	MG/KG	2.7	80%	0.1	10	55	69	0.04 J	0.07	0.06	0.04	0.03 J	0.04 J
Nickel	MG/KG	110	100%	49	2	69	69	29 J	33.2	24.4	26.8	22.5	29.5
Potassium	MG/KG	2180	100%	2380	0	69	69	810 J	1110	1150	970	992	1100
Selenium	MG/KG	1.8	19%	2	0	13	69	0.47 U	0.55 U	0.56 U	0.58 U	0.56 U	0.58 U
Silver	MG/KG	2.2	39%	0.75	15	27	69	1.4 J	0.55 U	0.56 U	0.58 U	0.56 U	0.58 U
Sodium	MG/KG	1040	97%	172	19	67	69	39.9	68.6	50.1 J	37.2 J	70	46.4 J
Thallium	MG/KG	2.3	26%	0.7	10	18	69	0.24 U	0.57 J	0.67 J	0.6 J	0.56 U	0.58 U
Vanadium	MG/KG	29.2	100%	150	0	69	69	17.9 J	19.1	20.7	20.3	18.3	21.1
Zinc	MG/KG	3660	99%	110	17	68	69	66.4 J	97.1 J	97.5 J	66.7 J	59.5 J	79.1 J

Note(s):
(1) - Historical sample depths are presented (I.e. prior to 2002 TCRA)
(2) - NYSDEC Technical and Administrative Guidance Memorandum (TAGM) HWR-94-4046

U = compound was not detected
J = the reported value is an estimated concentration

Table A-4A
SURFACE SOIL SAMPLE RESULTS (0-2 ft.)
SEAD-71
SEAD-59 and SEAD-71 Phase II RI Report
Seneca Army Depot Activity

Facility	SEAD-71	SEAD-71	SEAD-71	SEAD-71	SEAD-71	SEAD-71
Location ID	CL-71-E2-WN1	CL-71-E2-WS1	CL-71-E2-WW1	CL-71-E3-F01	CL-71-E3-WE1	CL-71-E3-WN1
Maxtrix	SOIL	SOIL	SOIL	SOIL	SOIL	SOIL
Sample ID	CL-71-E2-WN1	CL-71-E2-WS1	CL-71-E2-WW1	CL-71-E3-F01	CL-71-E3-WE1	CL-71-E3-WN1
Sample Depth to Top of Sample ⁽¹⁾	0	0	0	0	0	0
Sample Depth to Bottom of Sample ⁽¹⁾	0	0	0	0	0	0
Sample Date	5/6/2004	5/6/2004	5/6/2004	5/6/2004	5/6/2004	5/6/2004
QC Code	SA	SA	SA	SA	SA	SA
Study ID	ENSR IRM	ENSR IRM	ENSR IRM	ENSR IRM	ENSR IRM	ENSR IRM
Sample Round	1	1	1	1	1	1

Parameter	Units	Maximum Value	Frequency of Detection	NYSDEC TAGM 4046 ⁽²⁾	Number of Exceedances	Number of Detects	Number of Analyses	Value (Q)	Value (Q)	Value (Q)	Value (Q)	Value (Q)	Value (Q)

UJ = the compound was not detected; the associated reporting limit is approximate

R = the data was rejected in the data validating process

NJ = compound was "tentatively identified" and the associated numerical value is approximate

Table A-4A
SURFACE SOIL SAMPLE RESULTS (0-2 ft.)
SEAD-71
SEAD-59 and SEAD-71 Phase II RI Report
Seneca Army Depot Activity

Facility	SEAD-71	SEAD-71	SEAD-71	SEAD-71	SEAD-71	SEAD-71
Location ID	CL-71-E3-WS1	CL-71-E3-WW1	SS71-1	SS71-10	SS71-11	SS71-12
Maxtrix	SOIL	SOIL	SOIL	SOIL	SOIL	SOIL
Sample ID	CL-71-E3-WS1	CL-71-E3-WW1	71013	71017	71024	71023
Sample Depth to Top of Sample ⁽¹⁾	0	0	0	0	0	0
Sample Depth to Bottom of Sample ⁽¹⁾	0	0	0.2	0.2	0.2	0.2
Sample Date	5/6/2004	5/6/2004	11/19/1997	11/19/1997	11/20/1997	11/20/1997
QC Code	SA	SA	SA	SA	SA	SA
Study ID	ENSR IRM	ENSR IRM	RI PHASE 1 STEP 1	RI PHASE 1 STEP 1	RI PHASE 1 STEP 1	RI PHASE 1 STEP 1
Sample Round	1	1				

Parameter	Units	Maximum Value	Frequency of Detection	NYSDEC TAGM 4046 ⁽²⁾	Number of Exceedances	Number of Detects	Number of Analyses	Value (Q)					
								Value (Q)	Value (Q)	Value (Q)	Value (Q)	Value (Q)	Value (Q)
Volatile Organics													
1,1,1-Trichloroethane	UG/KG	3	3%	800	0	2	68	6 U	5.9 U	13 U	12 U	11 U	11 U
1,1,2,2-Tetrachloroethane	UG/KG	0	0%	600	0	0	64	6 U	5.9 U	13 U	12 U	11 U	11 U
1,1,2-Trichloro-1,2,2-Trifluoroethane	UG/KG	0	0%		0	0	44	6 U	5.9 U				
1,1,2-Trichloroethane	UG/KG	0	0%		0	0	47			13 U	12 U	11 U	11 U
1,1-Dichloroethane	UG/KG	0	0%	200	0	0	68	6 U	5.9 U	13 U	12 U	11 U	11 U
1,1-Dichloroethene	UG/KG	0	0%	400	0	0	68	6 U	5.9 U	13 U	12 U	11 U	11 U
1,2,3-Trichloropropane	UG/KG	0	0%		0	0	21	6 U	5.9 U				
1,2,4-Trichlorobenzene	UG/KG	0	0%	3400	0	0	40	6 U	5.9 U				
1,2-Dibromo-3-chloropropane	UG/KG	0	0%		0	0	19						
1,2-Dibromoethane	UG/KG	0	0%		0	0	23						
1,2-Dichlorobenzene	UG/KG	0	0%	7900	0	0	40	6 U	5.9 U				
1,2-Dichloroethane	UG/KG	0	0%	100	0	0	68	6 U	5.9 U	13 U	12 U	11 U	11 U
1,2-Dichloroethene (total)	UG/KG	0	0%		0	0	24			13 U	12 U	11 U	11 U
1,2-Dichloropropane	UG/KG	0	0%		0	0	47			13 U	12 U	11 U	11 U
1,3-Dichlorobenzene	UG/KG	0	0%	1600	0	0	40	6 U	5.9 U				
1,3-Dichloropropane	UG/KG	0	0%		0	0	21	6 U	5.9 U				
1,4-Dichlorobenzene	UG/KG	0	0%	8500	0	0	40	6 U	5.9 U				
Acetone	UG/KG	74	13%	200	0	9	68	24 UJ	24 UJ	13 U	12 U	11 U	11 U
Benzene	UG/KG	2	3%	60	0	2	68	6 U	5.9 U	2 J	12 U	11 U	11 U
Bromodichloromethane	UG/KG	0	0%		0	0	47			13 U	12 U	11 U	11 U
Bromoform	UG/KG	0	0%		0	0	47			13 U	12 U	11 U	11 U
Carbon disulfide	UG/KG	5	4%	2700	0	3	68	6 U	5.9 U	13 U	12 U	11 U	11 U
Carbon tetrachloride	UG/KG	0	0%	600	0	0	68	6 U	5.9 U	13 U	12 U	11 U	11 U
Chlorobenzene	UG/KG	0	0%	1700	0	0	68	6 U	5.9 U	13 U	12 U	11 U	11 U
Chlorodibromomethane	UG/KG	0	0%		0	0	68	6 U	5.9 U	13 U	12 U	11 U	11 U
Chloroethane	UG/KG	0	0%	1900	0	0	68	12 U	12 U	13 U	12 U	11 U	11 U
Chloroform	UG/KG	0	0%	300	0	0	68	6 U	5.9 U	13 U	12 U	11 U	11 U
Cis-1,2-Dichloroethene	UG/KG	0	0%		0	0	23						
Cis-1,3-Dichloropropene	UG/KG	0	0%		0	0	47			13 U	12 U	11 U	11 U
Cyclohexane	UG/KG	4	9%		0	2	23						
Dichlorodifluoromethane	UG/KG	0	0%		0	0	23						
Ethyl benzene	UG/KG	4	3%	5500	0	2	68	6 U	5.9 U	13 U	12 U	11 U	11 U
Isopropylbenzene	UG/KG	0	0%		0	0	23						
Meta/Para Xylene	UG/KG	0	0%		0	0	21	6 U	5.9 U				
Methyl Acetate	UG/KG	0	0%		0	0	23						
Methyl Tertbutyl Ether	UG/KG	0	0%		0	0	23						
Methyl bromide	UG/KG	0	0%		0	0	47			13 U	12 U	11 U	11 U

Table A-4A
SURFACE SOIL SAMPLE RESULTS (0-2 ft.)
SEAD-71
SEAD-59 and SEAD-71 Phase II RI Report
Seneca Army Depot Activity

Facility	SEAD-71	SEAD-71	SEAD-71	SEAD-71	SEAD-71	SEAD-71
Location ID	CL-71-E3-WS1	CL-71-E3-WW1	SS71-1	SS71-10	SS71-11	SS71-12
Maxtrix	SOIL	SOIL	SOIL	SOIL	SOIL	SOIL
Sample ID	CL-71-E3-WS1	CL-71-E3-WW1	71013	71017	71024	71023
Sample Depth to Top of Sample ⁽¹⁾	0	0	0	0	0	0
Sample Depth to Bottom of Sample ⁽¹⁾	0	0	0.2	0.2	0.2	0.2
Sample Date	5/6/2004	5/6/2004	11/19/1997	11/19/1997	11/20/1997	11/20/1997
QC Code	SA	SA	SA	SA	SA	SA
Study ID	ENSR IRM	ENSR IRM	RI PHASE 1 STEP 1	RI PHASE 1 STEP 1	RI PHASE 1 STEP 1	RI PHASE 1 STEP 1
Sample Round	1	1				

Parameter	Units	Maximum Frequency of		NYSDEC TAGM 4046 ⁽²⁾	Number of Exceedances	Number of Detects	Number of Analyses	Value (Q)	Value (Q)	Value (Q)	Value (Q)	Value (Q)	Value (Q)
		Value	Detection										
Methyl butyl ketone	UG/KG	0	0%		0	0	47			13 U	12 U	11 U	11 U
Methyl chloride	UG/KG	0	0%		0	0	47			13 U	12 U	11 U	11 U
Methyl cyclohexane	UG/KG	6	13%		0	3	23						
Methyl ethyl ketone	UG/KG	0	0%	300	0	0	68	12 U	12 U	13 U	12 U	11 U	11 U
Methyl isobutyl ketone	UG/KG	0	0%	1000	0	0	68	12 U	12 U	13 U	12 U	11 U	11 U
Methylene chloride	UG/KG	11	12%	100	0	8	68	6 U	5.9 U	2 J	12 U	11 U	11 U
Ortho Xylene	UG/KG	0	0%		0	0	21	6 U	5.9 U				
Styrene	UG/KG	1	2%		0	1	47			13 U	12 U	11 U	11 U
Tetrachloroethene	UG/KG	33	1%	1400	0	1	68	6 U	5.9 U	13 U	12 U	11 U	11 U
Toluene	UG/KG	16	16%	1500	0	11	68	6 U	5.9 U	4 J	12 U	4 J	4 J
Total BTEX	MG/KG	11.6	100%		0	1	1						
Total Xylenes	UG/KG	11	11%	1200	0	5	44			13 U	12 U	11 U	11 U
Trans-1,2-Dichloroethene	UG/KG	0	0%	300	0	0	44	6 U	5.9 U				
Trans-1,3-Dichloropropene	UG/KG	0	0%		0	0	47			13 U	12 U	11 U	11 U
Trichloroethene	UG/KG	0	0%	700	0	0	68	6 U	5.9 U	13 U	12 U	11 U	11 U
Trichlorofluoromethane	UG/KG	1	4%		0	1	23						
Vinyl chloride	UG/KG	0	0%	200	0	0	68	12 U	12 U	13 U	12 U	11 U	11 U
Semivolatile Organics													
1,1'-Biphenyl	UG/KG	0	0%		0	0	23						
1,2,4-Trichlorobenzene	UG/KG	0	0%	3400	0	0	24			300 U	93 U	72000 U	23000 U
1,2-Dichlorobenzene	UG/KG	0	0%	7900	0	0	24			300 U	93 U	72000 U	23000 U
1,3-Dichlorobenzene	UG/KG	0	0%	1600	0	0	24			300 U	93 U	72000 U	23000 U
1,4-Dichlorobenzene	UG/KG	0	0%	8500	0	0	24			300 U	93 U	72000 U	23000 U
2,2'-oxybis(1-Chloropropane)	UG/KG	0	0%		0	0	27						
2,4,5-Trichlorophenol	UG/KG	0	0%	100	0	0	69	400 U	1200 U	720 U	220 U	180000 U	56000 U
2,4,6-Trichlorophenol	UG/KG	0	0%		0	0	69	400 U	1200 U	300 U	93 U	72000 U	23000 U
2,4-Dichlorophenol	UG/KG	0	0%	400	0	0	69	400 U	1200 U	300 U	93 U	72000 U	23000 U
2,4-Dimethylphenol	UG/KG	0	0%		0	0	47			300 U	93 U	72000 U	23000 U
2,4-Dinitrophenol	UG/KG	0	0%	200	0	0	69	2000 UJ	6000 U	720 U	220 U	180000 U	56000 U
2,4-Dinitrotoluene	UG/KG	880	1%		0	1	69	400 U	1200 U	300 U	93 U	72000 U	23000 U
2,6-Dinitrotoluene	UG/KG	0	0%	1000	0	0	69	400 U	1200 U	300 U	93 U	72000 U	23000 U
2-Chloronaphthalene	UG/KG	0	0%		0	0	47			300 U	93 U	72000 U	23000 U
2-Chlorophenol	UG/KG	0	0%	800	0	0	69	400 U	1200 U	300 U	93 U	72000 U	23000 U
2-Methylnaphthalene	UG/KG	19000	22%	36400	0	15	69	400 U	1200 U	72 J	8.6 J	5300 J	4000 J
2-Methylphenol	UG/KG	0	0%	100	0	0	69	400 U	1200 U	300 U	93 U	72000 U	23000 U
2-Nitroaniline	UG/KG	0	0%	430	0	0	69	2000 U	6000 U	720 U	220 U	180000 U	56000 U
2-Nitrophenol	UG/KG	0	0%	330	0	0	69	400 U	1200 U	300 U	93 U	72000 U	23000 U
3,3'-Dichlorobenzidine	UG/KG	0	0%		0	0	69	400 U	1200 U	300 U	93 U	72000 U	23000 U

Table A-4A
SURFACE SOIL SAMPLE RESULTS (0-2 ft.)
SEAD-71
SEAD-59 and SEAD-71 Phase II RI Report
Seneca Army Depot Activity

Facility	SEAD-71	SEAD-71	SEAD-71	SEAD-71	SEAD-71	SEAD-71
Location ID	CL-71-E3-WS1	CL-71-E3-WW1	SS71-1	SS71-10	SS71-11	SS71-12
Maxtrix	SOIL	SOIL	SOIL	SOIL	SOIL	SOIL
Sample ID	CL-71-E3-WS1	CL-71-E3-WW1	71013	71017	71024	71023
Sample Depth to Top of Sample ⁽¹⁾	0	0	0	0	0	0
Sample Depth to Bottom of Sample ⁽¹⁾	0	0	0.2	0.2	0.2	0.2
Sample Date	5/6/2004	5/6/2004	11/19/1997	11/19/1997	11/20/1997	11/20/1997
QC Code	SA	SA	SA	SA	SA	SA
Study ID	ENSR IRM	ENSR IRM	RI PHASE 1 STEP 1	RI PHASE 1 STEP 1	RI PHASE 1 STEP 1	RI PHASE 1 STEP 1
Sample Round	1	1				

Parameter	Units	Maximum Frequency of		NYSDEC TAGM 4046 ⁽²⁾	Number of Exceedances	Number of Detects	Number of Analyses	Value (Q)	Value (Q)	Value (Q)	Value (Q)	Value (Q)	Value (Q)
		Value	Detection										
3-Nitroaniline	UG/KG	0	0%	500	0	0	69	2000 U	6000 U	720 U	220 U	180000 U	56000 U
4,6-Dinitro-2-methylphenol	UG/KG	0	0%		0	0	47			720 U	220 U	180000 U	56000 U
4-Bromophenyl phenyl ether	UG/KG	0	0%		0	0	47			300 U	93 U	72000 U	23000 U
4-Chloro-3-methylphenol	UG/KG	0	0%	240	0	0	69	400 U	1200 U	300 U	93 U	72000 U	23000 U
4-Chloroaniline	UG/KG	0	0%	220	0	0	69	400 U	1200 U	300 U	93 U	72000 U	23000 U
4-Chlorophenyl phenyl ether	UG/KG	0	0%		0	0	47			300 U	93 U	72000 U	23000 U
4-Methylphenol	UG/KG	0	0%	900	0	0	69	400 U	1200 U	300 U	93 U	72000 U	23000 U
4-Nitroaniline	UG/KG	75	2%		0	1	47			720 U	220 U	180000 U	56000 U
4-Nitrophenol	UG/KG	0	0%	100	0	0	69	2000 U	6000 U	720 U	220 U	180000 U	56000 U
Acenaphthene	UG/KG	42000	42%	50000	0	29	69	400 U	1200 U	300 U	22 J	28000 J	12000 J
Acenaphthylene	UG/KG	1800	28%	41000	0	19	69	400 U	1200 U	300 U	93 U	72000 U	23000 U
Acetophenone	UG/KG	0	0%		0	0	23						
Aniline	UG/KG	0	0%		0	0	22	400 U	1200 U				
Anthracene	UG/KG	100000	59%	50000	3	41	69	400 U	1200 U	68 J	47 J	100000	32000
Atrazine	UG/KG	0	0%		0	0	23						
Benzaldehyde	UG/KG	0	0%		0	0	23						
Benzo(a)anthracene	UG/KG	150000	77%	224	40	53	69	400 U	240 J	500	220	150000	38000
Benzo(a)pyrene	UG/KG	120000	77%	61	47	53	69	400 U	250 J	550	220	120000	34000
Benzo(b)fluoranthene	UG/KG	88000	78%	1100	23	54	69	400 U	300 J	750	280	88000	21000 J
Benzo(ghi)perylene	UG/KG	62000	70%	50000	1	48	69	400 U	230 J	370	140	62000 J	19000 J
Benzo(k)fluoranthene	UG/KG	130000	61%	1100	20	42	69	400 U	290 J	750	250	130000	39000
Benzoic Acid	UG/KG	0	0%	2700	0	0	22	2000 UJ	6000 UJ				
Bis(2-Chloroethoxy)methane	UG/KG	0	0%		0	0	47			300 U	93 U	72000 U	23000 U
Bis(2-Chloroethyl)ether	UG/KG	0	0%		0	0	47			300 U	93 U	72000 U	23000 U
Bis(2-Chloroisopropyl)ether	UG/KG	0	0%		0	0	20			300 U	93 U	72000 U	23000 U
Bis(2-Ethylhexyl)phthalate	UG/KG	140	9%	50000	0	6	69	400 U	1200 U	300 U	93 U	72000 U	23000 U
Butylbenzylphthalate	UG/KG	0	0%	50000	0	0	69	400 U	1200 U	300 U	93 U	72000 U	23000 U
Caprolactam	UG/KG	0	0%		0	0	23						
Carbazole	UG/KG	77000	57%		0	27	47			110 J	75 J	39000 J	20000 J
Chrysene	UG/KG	150000	81%	400	37	56	69	43 J	370 J	930	290	150000	37000
Di-n-butylphthalate	UG/KG	140	6%	8100	0	4	69	400 U	1200 U	300 U	93 U	72000 U	23000 U
Di-n-octylphthalate	UG/KG	0	0%	50000	0	0	69	400 U	1200 U	300 U	93 U	72000 U	23000 U
Dibenz(a,h)anthracene	UG/KG	25000	58%	14	40	40	69	400 U	1200 U	130 J	51 J	25000 J	8200 J
Dibenzofuran	UG/KG	38000	39%	6200	4	27	69	400 U	1200 U	100 J	13 J	14000 J	10000 J
Diethyl phthalate	UG/KG	0	0%	7100	0	0	69	400 U	1200 U	300 U	93 U	72000 U	23000 U
Dimethylphthalate	UG/KG	0	0%	2000	0	0	69	400 U	1200 U	300 U	93 U	72000 U	23000 U
Fluoranthene	UG/KG	440000	84%	50000	6	58	69	58 J	640 J	1100	480	440000	96000
Fluorene	UG/KG	62000	41%	50000	1	28	69	400 U	1200 U	300 U	18 J	35000 J	19000 J

Table A-4A
SURFACE SOIL SAMPLE RESULTS (0-2 ft.)
SEAD-71
SEAD-59 and SEAD-71 Phase II RI Report
Seneca Army Depot Activity

Facility	SEAD-71	SEAD-71	SEAD-71	SEAD-71	SEAD-71	SEAD-71
Location ID	CL-71-E3-WS1	CL-71-E3-WW1	SS71-1	SS71-10	SS71-11	SS71-12
Maxtrix	SOIL	SOIL	SOIL	SOIL	SOIL	SOIL
Sample ID	CL-71-E3-WS1	CL-71-E3-WW1	71013	71017	71024	71023
Sample Depth to Top of Sample ⁽¹⁾	0	0	0	0	0	0
Sample Depth to Bottom of Sample ⁽¹⁾	0	0	0.2	0.2	0.2	0.2
Sample Date	5/6/2004	5/6/2004	11/19/1997	11/19/1997	11/20/1997	11/20/1997
QC Code	SA	SA	SA	SA	SA	SA
Study ID	ENSR IRM	ENSR IRM	RI PHASE 1 STEP 1	RI PHASE 1 STEP 1	RI PHASE 1 STEP 1	RI PHASE 1 STEP 1
Sample Round	1	1				

Parameter	Units	Maximum Frequency of		NYSDEC TAGM 4046 ⁽²⁾	Number of Exceedances	Number of Detects	Number of Analyses	Value (Q)	Value (Q)	Value (Q)	Value (Q)	Value (Q)	Value (Q)
		Value	Detection										
Hexachlorobenzene	UG/KG	0	0%	410	0	0	69	400 U	1200 U	300 U	93 U	72000 U	23000 U
Hexachlorobutadiene	UG/KG	0	0%		0	0	69	400 U	1200 U	300 U	93 U	72000 U	23000 U
Hexachlorocyclopentadiene	UG/KG	0	0%		0	0	47			300 U	93 U	72000 U	23000 U
Hexachloroethane	UG/KG	0	0%		0	0	69	400 U	1200 U	300 U	93 U	72000 U	23000 U
Indeno(1,2,3-cd)pyrene	UG/KG	65000	70%	3200	11	48	69	400 U	190 J	360	140	65000 J	19000 J
Isophorone	UG/KG	0	0%	4400	0	0	69	400 U	1200 U	300 U	93 U	72000 U	23000 U
N-Nitrosodiphenylamine	UG/KG	0	0%		0	0	47			300 U	93 U	72000 U	23000 U
N-Nitrosodipropylamine	UG/KG	0	0%		0	0	47			300 U	93 U	72000 U	23000 U
Naphthalene	UG/KG	46000	22%	13000	1	15	69	400 U	1200 U	78 J	93 U	6000 J	8000 J
Nitrobenzene	UG/KG	0	0%	200	0	0	69	400 U	1200 U	300 U	93 U	72000 U	23000 U
Pentachlorophenol	UG/KG	0	0%	1000	0	0	69	2000 U	6000 U	720 U	220 U	180000 U	56000 U
Phenanthrene	UG/KG	290000	78%	50000	5	54	69	400 U	210 J	440	210	280000	98000
Phenol	UG/KG	4.5	1%	30	0	1	69	400 U	1200 U	300 U	93 U	72000 U	23000 U
Pyrene	UG/KG	280000	81%	50000	6	56	69	400 U	400 J	900	380	280000	74000
Pyridine	UG/KG	0	0%		0	0	22	2000 U	6000 U				
Pesticides/PCBs													
4,4'-DDD	UG/KG	240	26%	2900	0	18	69	20 U	19 U	5.9	4.6 U	26 J	35 U
4,4'-DDE	UG/KG	810	42%	2100	0	29	69	20 U	19 U	88	22	26 J	35 U
4,4'-DDT	UG/KG	1300	51%	2100	0	35	69	20 U	19 U	54	25	43	35 U
Aldrin	UG/KG	0	0%	41	0	0	69	10 U	10 U	2.3 U	2.4 U	19 U	18 U
Alpha-BHC	UG/KG	18	7%	110	0	5	69	10 U	10 U	2.2 J	2.4 U	19 U	18 U
Alpha-Chlordane	UG/KG	2	1%		0	1	69	10 U	10 U	2.3 U	2.4 U	19 U	18 U
Beta-BHC	UG/KG	35	9%	200	0	6	69	10 U	10 U	2.3 U	2.4 U	21	18 U
Delta-BHC	UG/KG	0	0%	300	0	0	69	10 U	10 U	2.3 U	2.4 U	19 U	18 U
Dieldrin	UG/KG	3.4	3%	44	0	2	69	20 U	19 U	4.4 U	4.6 U	37 U	35 U
Endosulfan I	UG/KG	15	10%	900	0	7	69	10 U	10 U	2.3 U	2.4 U	15 J	18 U
Endosulfan II	UG/KG	52	4%	900	0	3	69	20 U	19 U	4.4 U	4.6 U	37 U	35 U
Endosulfan sulfate	UG/KG	110	16%	1000	0	11	69	20 U	19 U	2.7 J	4.6 U	37 U	48
Endrin	UG/KG	120	14%	100	1	10	69	20 U	19 U	6.3	4.6 U	55	35 U
Endrin aldehyde	UG/KG	120	23%		0	16	69	20 U	19 U	4.8	9.1	70	34 J
Endrin ketone	UG/KG	180	22%		0	15	69	20 U	19 U	7.7	17	160	35 U
Gamma-BHC/Lindane	UG/KG	0	0%	60	0	0	69	10 U	10 U	2.3 U	2.4 U	19 U	18 U
Gamma-Chlordane	UG/KG	48	6%	540	0	4	69	10 U	10 U	1.2 J	2.4 U	19 U	18 U
Heptachlor	UG/KG	0	0%	100	0	0	69	10 U	10 U	2.3 U	2.4 U	19 U	18 U
Heptachlor epoxide	UG/KG	180	17%	20	4	12	69	10 U	10 U	4.3	2.4 U	17 J	18 U
Methoxychlor	UG/KG	520	16%		0	11	69	100 U	100 U	23 U	24 U	270	210
Toxaphene	UG/KG	0	0%		0	0	69	200 U	190 U	230 U	240 U	1900 U	1800 U
Aroclor-1016	UG/KG	0	0%		0	0	69	40 U	39 U	44 U	46 U	370 U	350 U

Table A-4A
SURFACE SOIL SAMPLE RESULTS (0-2 ft.)
SEAD-71
SEAD-59 and SEAD-71 Phase II RI Report
Seneca Army Depot Activity

Facility	SEAD-71	SEAD-71	SEAD-71	SEAD-71	SEAD-71	SEAD-71
Location ID	CL-71-E3-WS1	CL-71-E3-WW1	SS71-1	SS71-10	SS71-11	SS71-12
Maxtrix	SOIL	SOIL	SOIL	SOIL	SOIL	SOIL
Sample ID	CL-71-E3-WS1	CL-71-E3-WW1	71013	71017	71024	71023
Sample Depth to Top of Sample ⁽¹⁾	0	0	0	0	0	0
Sample Depth to Bottom of Sample ⁽¹⁾	0	0	0.2	0.2	0.2	0.2
Sample Date	5/6/2004	5/6/2004	11/19/1997	11/19/1997	11/20/1997	11/20/1997
QC Code	SA	SA	SA	SA	SA	SA
Study ID	ENSR IRM	ENSR IRM	RI PHASE 1 STEP 1	RI PHASE 1 STEP 1	RI PHASE 1 STEP 1	RI PHASE 1 STEP 1
Sample Round	1	1				

Parameter	Units	Maximum Frequency of		NYSDEC TAGM 4046 ⁽²⁾	Number of Exceedances	Number of Detects	Number of Analyses	Value (Q)	Value (Q)	Value (Q)	Value (Q)	Value (Q)	Value (Q)
		Value	Detection										
Aroclor-1221	UG/KG	0	0%		0	0	69	40 U	39 U	90 U	94 U	740 U	700 U
Aroclor-1232	UG/KG	0	0%		0	0	69	40 U	39 U	44 U	46 U	370 U	350 U
Aroclor-1242	UG/KG	0	0%		0	0	69	40 U	39 U	44 U	46 U	370 U	350 U
Aroclor-1248	UG/KG	0	0%		0	0	69	40 U	39 U	44 U	46 U	370 U	350 U
Aroclor-1254	UG/KG	0	0%	10000	0	0	69	40 U	39 U	44 U	46 U	370 U	350 U
Aroclor-1260	UG/KG	200	4%	10000	0	3	69	40 U	39 U	44 U	46 U	370 U	350 U
Metals													
Aluminum	MG/KG	18000	100%	19300	0	69	69	14900	11000	7250	9080	2900	2450
Antimony	MG/KG	19.3	49%	5.9	5	34	69	3.5 UJ	3.5 UJ	1.9 J	0.95 UJ	0.98 J	0.7 UJ
Arsenic	MG/KG	14.6	100%	8.2	5	69	69	5.9 J	4.8 J	4.9	7.4	5.8	3.2
Barium	MG/KG	179	100%	300	0	69	69	116	55.5	51.2 J	53.4 J	50.5 J	88.1 J
Beryllium	MG/KG	0.88	99%	1.1	0	68	69	0.43	0.27	0.26 J	0.25	0.08	0.08
Cadmium	MG/KG	12.1	67%	2.3	4	46	69	0.71	0.53 J	0.08 UJ	0.08 UJ	5.2 J	0.06 UJ
Calcium	MG/KG	295000	100%	121000	11	69	69	18800 J	70700 J	35100	11100	205000	222000
Chromium	MG/KG	60.3	100%	29.6	5	69	69	21.3	15	13.4 J	14.2 J	19.1 J	5.8 J
Cobalt	MG/KG	14.6	100%	30	0	69	69	13.9	9.9	7.4	8.7	5.6	4.3
Copper	MG/KG	134	100%	33	21	69	69	22.6	16.5	47.7 J	28.8 J	24.8 J	5.4 J
Cyanide	MG/KG	0	0%	0.35	0	24	69	0.67 U	0.67 U	0.74 U	0.59 U	0.59 U	0.59 U
Iron	MG/KG	65100	100%	36500	2	69	69	27900	19400	31800	24100	19100	5990
Lead	MG/KG	3470	100%	24.8	33	69	69	17.8	19.8	185 J	28.5 J	92.8 J	16.9 J
Magnesium	MG/KG	59300	100%	21500	6	69	69	7040	6780	5050	4170	24500	34300
Manganese	MG/KG	1330	100%	1060	1	69	69	1330	615	383 J	554 J	361 J	286 J
Mercury	MG/KG	2.7	80%	0.1	10	55	69	0.04	0.03 J	0.14 J	0.07 UJ	0.29 J	0.05 UJ
Nickel	MG/KG	110	100%	49	2	69	69	30	20.1	19.9	110	18.2	11.9
Potassium	MG/KG	2180	100%	2380	0	69	69	1100	908	1330	1030	1190	1370
Selenium	MG/KG	1.8	19%	2	0	13	69	0.58 U	0.58 U	1.4 J	1.8 J	0.99 UJ	0.94 UJ
Silver	MG/KG	2.2	39%	0.75	15	27	69	0.58 U	0.58 U	0.54 UJ	0.57 UJ	2.2 J	0.42 UJ
Sodium	MG/KG	1040	97%	172	19	67	69	49.2 J	78.4	215	636	324	257
Thallium	MG/KG	2.3	26%	0.7	10	18	69	0.83 J	0.58 U	1.6 U	1.7 U	1.3 U	1.3 U
Vanadium	MG/KG	29.2	100%	150	0	69	69	21.6	19.3	16	13.7	14.8	10
Zinc	MG/KG	3660	99%	110	17	68	69	71.3 J	51.8 J	95.3 J	1740 J	201 J	44.7 J

Note(s):
(1) - Historical sample depths are presented (I.e. prior to 2002 TCRA)
(2) - NYSDEC Technical and Administrative Guidance Memorandum (TAGM) HWR-94-4046

U = compound was not detected
J = the reported value is an estimated concentration

Table A-4A
SURFACE SOIL SAMPLE RESULTS (0-2 ft.)
SEAD-71
SEAD-59 and SEAD-71 Phase II RI Report
Seneca Army Depot Activity

Facility	SEAD-71	SEAD-71	SEAD-71	SEAD-71	SEAD-71	SEAD-71
Location ID	CL-71-E3-WS1	CL-71-E3-WW1	SS71-1	SS71-10	SS71-11	SS71-12
Maxtrix	SOIL	SOIL	SOIL	SOIL	SOIL	SOIL
Sample ID	CL-71-E3-WS1	CL-71-E3-WW1	71013	71017	71024	71023
Sample Depth to Top of Sample ⁽¹⁾	0	0	0	0	0	0
Sample Depth to Bottom of Sample ⁽¹⁾	0	0	0.2	0.2	0.2	0.2
Sample Date	5/6/2004	5/6/2004	11/19/1997	11/19/1997	11/20/1997	11/20/1997
QC Code	SA	SA	SA	SA	SA	SA
Study ID	ENSR IRM	ENSR IRM	RI PHASE 1 STEP 1	RI PHASE 1 STEP 1	RI PHASE 1 STEP 1	RI PHASE 1 STEP 1
Sample Round	1	1				

Parameter	Units	Maximum Value	Frequency of Detection	NYSDEC TAGM 4046 ⁽²⁾	Number of Exceedances	Number of Detects	Number of Analyses	Value (Q)	Value (Q)	Value (Q)	Value (Q)	Value (Q)	Value (Q)

UJ = the compound was not detected; the associated reporting limit is approximate

R = the data was rejected in the data validating process

NJ = compound was "tentatively identified" and the associated numerical value is approximate

Table A-4A
SURFACE SOIL SAMPLE RESULTS (0-2 ft.)
SEAD-71
SEAD-59 and SEAD-71 Phase II RI Report
Seneca Army Depot Activity

Facility	SEAD-71	SEAD-71	SEAD-71	SEAD-71	SEAD-71	SEAD-71
Location ID	SS71-13	SS71-14	SS71-15	SS71-16	SS71-17	SS71-18
Maxtrix	SOIL	SOIL	SOIL	SOIL	SOIL	SOIL
Sample ID	71027	71025	71032	71021	71030	71022
Sample Depth to Top of Sample ⁽¹⁾	0	0	0	0	0	0
Sample Depth to Bottom of Sample ⁽¹⁾	0.2	0.2	0.2	0.2	0.2	0.2
Sample Date	11/21/1997	11/20/1997	11/21/1997	11/20/1997	11/21/1997	11/20/1997
QC Code	SA	SA	SA	SA	SA	SA
Study ID	RI PHASE 1 STEP 1	RI PHASE 1 STEP 1	RI PHASE 1 STEP 1	RI PHASE 1 STEP 1	RI PHASE 1 STEP 1	RI PHASE 1 STEP 1
Sample Round						

Parameter	Units	Maximum	Frequency of	NYSDEC	Number of	Number of	Number of	Value (Q)	Value (Q)	Value (Q)	Value (Q)	Value (Q)	Value (Q)
		Value	Detection	TAGM 4046 ⁽²⁾	Exceedances	Detects	Analyses						
Volatile Organics													
1,1,1-Trichloroethane	UG/KG	3	3%	800	0	2	68	18 U	12 U	13 U	12 U	11 U	11 U
1,1,2,2-Tetrachloroethane	UG/KG	0	0%	600	0	0	64	18 U	12 U	13 U	12 U	11 U	11 U
1,1,2-Trichloro-1,2,2-Trifluoroethane	UG/KG	0	0%		0	0	44						
1,1,2-Trichloroethane	UG/KG	0	0%		0	0	47	18 U	12 U	13 U	12 U	11 U	11 U
1,1-Dichloroethane	UG/KG	0	0%	200	0	0	68	18 U	12 U	13 U	12 U	11 U	11 U
1,1-Dichloroethene	UG/KG	0	0%	400	0	0	68	18 U	12 U	13 U	12 U	11 U	11 U
1,2,3-Trichloropropane	UG/KG	0	0%		0	0	21						
1,2,4-Trichlorobenzene	UG/KG	0	0%	3400	0	0	40						
1,2-Dibromo-3-chloropropane	UG/KG	0	0%		0	0	19						
1,2-Dibromoethane	UG/KG	0	0%		0	0	23						
1,2-Dichlorobenzene	UG/KG	0	0%	7900	0	0	40						
1,2-Dichloroethane	UG/KG	0	0%	100	0	0	68	18 U	12 U	13 U	12 U	11 U	11 U
1,2-Dichloroethene (total)	UG/KG	0	0%		0	0	24	18 U	12 U	13 U	12 U	11 U	11 U
1,2-Dichloropropane	UG/KG	0	0%		0	0	47	18 U	12 U	13 U	12 U	11 U	11 U
1,3-Dichlorobenzene	UG/KG	0	0%	1600	0	0	40						
1,3-Dichloropropane	UG/KG	0	0%		0	0	21						
1,4-Dichlorobenzene	UG/KG	0	0%	8500	0	0	40						
Acetone	UG/KG	74	13%	200	0	9	68	18 U	74	13 U	12 U	11 U	11 U
Benzene	UG/KG	2	3%	60	0	2	68	18 U	12 U	13 U	12 U	11 U	11 U
Bromodichloromethane	UG/KG	0	0%		0	0	47	18 U	12 U	13 U	12 U	11 U	11 U
Bromoform	UG/KG	0	0%		0	0	47	18 U	12 U	13 U	12 U	11 U	11 U
Carbon disulfide	UG/KG	5	4%	2700	0	3	68	18 U	12 U	13 U	12 U	11 U	11 U
Carbon tetrachloride	UG/KG	0	0%	600	0	0	68	18 U	12 U	13 U	12 U	11 U	11 U
Chlorobenzene	UG/KG	0	0%	1700	0	0	68	18 U	12 U	13 U	12 U	11 U	11 U
Chlorodibromomethane	UG/KG	0	0%		0	0	68	18 U	12 U	13 U	12 U	11 U	11 U
Chloroethane	UG/KG	0	0%	1900	0	0	68	18 U	12 U	13 U	12 U	11 U	11 U
Chloroform	UG/KG	0	0%	300	0	0	68	18 U	12 U	13 U	12 U	11 U	11 U
Cis-1,2-Dichloroethene	UG/KG	0	0%		0	0	23						
Cis-1,3-Dichloropropene	UG/KG	0	0%		0	0	47	18 U	12 U	13 U	12 U	11 U	11 U
Cyclohexane	UG/KG	4	9%		0	2	23						
Dichlorodifluoromethane	UG/KG	0	0%		0	0	23						
Ethyl benzene	UG/KG	4	3%	5500	0	2	68	4 J	12 U	13 U	12 U	11 U	11 U
Isopropylbenzene	UG/KG	0	0%		0	0	23						
Meta/Para Xylene	UG/KG	0	0%		0	0	21						
Methyl Acetate	UG/KG	0	0%		0	0	23						
Methyl Tertbutyl Ether	UG/KG	0	0%		0	0	23						
Methyl bromide	UG/KG	0	0%		0	0	47	18 U	12 U	13 U	12 U	11 U	11 U

Table A-4A
SURFACE SOIL SAMPLE RESULTS (0-2 ft.)
SEAD-71
SEAD-59 and SEAD-71 Phase II RI Report
Seneca Army Depot Activity

Facility	SEAD-71	SEAD-71	SEAD-71	SEAD-71	SEAD-71	SEAD-71
Location ID	SS71-13	SS71-14	SS71-15	SS71-16	SS71-17	SS71-18
Maxtrix	SOIL	SOIL	SOIL	SOIL	SOIL	SOIL
Sample ID	71027	71025	71032	71021	71030	71022
Sample Depth to Top of Sample ⁽¹⁾	0	0	0	0	0	0
Sample Depth to Bottom of Sample ⁽¹⁾	0.2	0.2	0.2	0.2	0.2	0.2
Sample Date	11/21/1997	11/20/1997	11/21/1997	11/20/1997	11/21/1997	11/20/1997
QC Code	SA	SA	SA	SA	SA	SA
Study ID	RI PHASE 1 STEP 1	RI PHASE 1 STEP 1	RI PHASE 1 STEP 1	RI PHASE 1 STEP 1	RI PHASE 1 STEP 1	RI PHASE 1 STEP 1
Sample Round						

Parameter	Units	Maximum Frequency of		NYSDEC TAGM 4046 ⁽²⁾	Number of Exceedances	Number of Detects	Number of Analyses	Value (Q)	Value (Q)	Value (Q)	Value (Q)	Value (Q)	Value (Q)
		Value	Detection										
Methyl butyl ketone	UG/KG	0	0%		0	0	47	18 U	12 U	13 U	12 U	11 U	11 U
Methyl chloride	UG/KG	0	0%		0	0	47	18 U	12 U	13 U	12 U	11 U	11 U
Methyl cyclohexane	UG/KG	6	13%		0	3	23						
Methyl ethyl ketone	UG/KG	0	0%	300	0	0	68	18 U	12 U	13 U	12 U	11 U	11 U
Methyl isobutyl ketone	UG/KG	0	0%	1000	0	0	68	18 U	12 U	13 U	12 U	11 U	11 U
Methylene chloride	UG/KG	11	12%	100	0	8	68	18 U	12 U	13 U	12 U	11 U	11 U
Ortho Xylene	UG/KG	0	0%		0	0	21						
Styrene	UG/KG	1	2%		0	1	47	18 U	12 U	13 U	12 U	11 U	11 U
Tetrachloroethene	UG/KG	33	1%	1400	0	1	68	18 U	12 U	13 U	33	11 U	11 U
Toluene	UG/KG	16	16%	1500	0	11	68	9 J	12 U	2 J	12 U	16	11 U
Total BTEX	MG/KG	11.6	100%		0	1	1						
Total Xylenes	UG/KG	11	11%	1200	0	5	44	11 J	12 U	13 U	12 U	11 U	11 U
Trans-1,2-Dichloroethene	UG/KG	0	0%	300	0	0	44						
Trans-1,3-Dichloropropene	UG/KG	0	0%		0	0	47	18 U	12 U	13 U	12 U	11 U	11 U
Trichloroethene	UG/KG	0	0%	700	0	0	68	18 U	12 U	13 U	12 U	11 U	11 U
Trichlorofluoromethane	UG/KG	1	4%		0	1	23						
Vinyl chloride	UG/KG	0	0%	200	0	0	68	18 U	12 U	13 U	12 U	11 U	11 U
Semivolatle Organics													
1,1'-Biphenyl	UG/KG	0	0%		0	0	23						
1,2,4-Trichlorobenzene	UG/KG	0	0%	3400	0	0	24	70000 U	89 U	8400 U	39000 U	35000 U	900 U
1,2-Dichlorobenzene	UG/KG	0	0%	7900	0	0	24	70000 U	89 U	8400 U	39000 U	35000 U	900 U
1,3-Dichlorobenzene	UG/KG	0	0%	1600	0	0	24	70000 U	89 U	8400 U	39000 U	35000 U	900 U
1,4-Dichlorobenzene	UG/KG	0	0%	8500	0	0	24	70000 U	89 U	8400 U	39000 U	35000 U	900 U
2,2'-oxybis(1-Chloropropane)	UG/KG	0	0%		0	0	27						
2,4,5-Trichlorophenol	UG/KG	0	0%	100	0	0	69	170000 U	220 U	20000 U	94000 U	85000 U	2200 U
2,4,6-Trichlorophenol	UG/KG	0	0%		0	0	69	70000 U	89 U	8400 U	39000 U	35000 U	900 U
2,4-Dichlorophenol	UG/KG	0	0%	400	0	0	69	70000 U	89 U	8400 U	39000 U	35000 U	900 U
2,4-Dimethylphenol	UG/KG	0	0%		0	0	47	70000 U	89 U	8400 U	39000 U	35000 U	900 U
2,4-Dinitrophenol	UG/KG	0	0%	200	0	0	69	170000 U	220 U	20000 U	94000 U	85000 U	2200 U
2,4-Dinitrotoluene	UG/KG	880	1%		0	1	69	70000 U	89 U	8400 U	39000 U	35000 U	900 U
2,6-Dinitrotoluene	UG/KG	0	0%	1000	0	0	69	70000 U	89 U	8400 U	39000 U	35000 U	900 U
2-Chloronaphthalene	UG/KG	0	0%		0	0	47	70000 U	89 U	8400 U	39000 U	35000 U	900 U
2-Chlorophenol	UG/KG	0	0%	800	0	0	69	70000 U	89 U	8400 U	39000 U	35000 U	900 U
2-Methylnaphthalene	UG/KG	19000	22%	36400	0	15	69	19000 J	23 J	8400 U	39000 U	5100 J	56 J
2-Methylphenol	UG/KG	0	0%	100	0	0	69	70000 U	89 U	8400 U	39000 U	35000 U	900 U
2-Nitroaniline	UG/KG	0	0%	430	0	0	69	170000 U	220 U	20000 U	94000 U	85000 U	2200 U
2-Nitrophenol	UG/KG	0	0%	330	0	0	69	70000 U	89 U	8400 U	39000 U	35000 U	900 U
3,3'-Dichlorobenzidine	UG/KG	0	0%		0	0	69	70000 U	89 U	8400 U	39000 U	35000 U	900 U

Table A-4A
SURFACE SOIL SAMPLE RESULTS (0-2 ft.)
SEAD-71
SEAD-59 and SEAD-71 Phase II RI Report
Seneca Army Depot Activity

Facility	SEAD-71	SEAD-71	SEAD-71	SEAD-71	SEAD-71	SEAD-71
Location ID	SS71-13	SS71-14	SS71-15	SS71-16	SS71-17	SS71-18
Maxtrix	SOIL	SOIL	SOIL	SOIL	SOIL	SOIL
Sample ID	71027	71025	71032	71021	71030	71022
Sample Depth to Top of Sample ⁽¹⁾	0	0	0	0	0	0
Sample Depth to Bottom of Sample ⁽¹⁾	0.2	0.2	0.2	0.2	0.2	0.2
Sample Date	11/21/1997	11/20/1997	11/21/1997	11/20/1997	11/21/1997	11/20/1997
QC Code	SA	SA	SA	SA	SA	SA
Study ID	RI PHASE 1 STEP 1	RI PHASE 1 STEP 1	RI PHASE 1 STEP 1	RI PHASE 1 STEP 1	RI PHASE 1 STEP 1	RI PHASE 1 STEP 1
Sample Round						

Parameter	Units	Maximum Frequency of		NYSDEC TAGM 4046 ⁽²⁾	Number of Exceedances	Number of Detects	Number of Analyses	Value (Q)	Value (Q)	Value (Q)	Value (Q)	Value (Q)	Value (Q)
		Value	Detection										
3-Nitroaniline	UG/KG	0	0%	500	0	0	69	170000 U	220 U	20000 U	94000 U	85000 U	2200 U
4,6-Dinitro-2-methylphenol	UG/KG	0	0%		0	0	47	170000 U	220 U	20000 U	94000 U	85000 U	2200 U
4-Bromophenyl phenyl ether	UG/KG	0	0%		0	0	47	70000 U	89 U	8400 U	39000 U	35000 U	900 U
4-Chloro-3-methylphenol	UG/KG	0	0%	240	0	0	69	70000 U	89 U	8400 U	39000 U	35000 U	900 U
4-Chloroaniline	UG/KG	0	0%	220	0	0	69	70000 U	89 U	8400 U	39000 U	35000 U	900 U
4-Chlorophenyl phenyl ether	UG/KG	0	0%		0	0	47	70000 U	89 U	8400 U	39000 U	35000 U	900 U
4-Methylphenol	UG/KG	0	0%	900	0	0	69	70000 U	89 U	8400 U	39000 U	35000 U	900 U
4-Nitroaniline	UG/KG	75	2%		0	1	47	170000 U	220 U	20000 U	94000 U	85000 U	2200 U
4-Nitrophenol	UG/KG	0	0%	100	0	0	69	170000 U	220 U	20000 U	94000 U	85000 U	2200 U
Acenaphthene	UG/KG	42000	42%	50000	0	29	69	42000 J	10 J	1600 J	6400 J	30000 J	230 J
Acenaphthylene	UG/KG	1800	28%	41000	0	19	69	70000 U	20 J	8400 U	39000 U	35000 U	900 U
Acetophenone	UG/KG	0	0%		0	0	23						
Aniline	UG/KG	0	0%		0	0	22						
Anthracene	UG/KG	100000	59%	50000	3	41	69	100000	380	7900 J	30000 J	77000	390 J
Atrazine	UG/KG	0	0%		0	0	23						
Benzaldehyde	UG/KG	0	0%		0	0	23						
Benzo(a)anthracene	UG/KG	150000	77%	224	40	53	69	100000	360	18000	91000	120000	2200
Benzo(a)pyrene	UG/KG	120000	77%	61	47	53	69	80000	350	16000	70000	96000	2100
Benzo(b)fluoranthene	UG/KG	88000	78%	1100	23	54	69	63000 J	830	14000	59000	78000	4000
Benzo(ghi)perylene	UG/KG	62000	70%	50000	1	48	69	42000 J	220	12000	36000 J	46000	1300
Benzo(k)fluoranthene	UG/KG	130000	61%	1100	20	42	69	76000	89 U	19000	74000	93000	900 U
Benzoic Acid	UG/KG	0	0%	2700	0	0	22						
Bis(2-Chloroethoxy)methane	UG/KG	0	0%		0	0	47	70000 U	89 U	8400 U	39000 U	35000 U	900 U
Bis(2-Chloroethyl)ether	UG/KG	0	0%		0	0	47	70000 U	89 U	8400 U	39000 U	35000 U	900 U
Bis(2-Chloroisopropyl)ether	UG/KG	0	0%		0	0	20	70000 U	89 U	8400 U	39000 U	35000 U	900 U
Bis(2-Ethylhexyl)phthalate	UG/KG	140	9%	50000	0	6	69	70000 U	89 U	8400 U	39000 U	35000 U	900 U
Butylbenzylphthalate	UG/KG	0	0%	50000	0	0	69	70000 U	89 U	8400 U	39000 U	35000 U	900 U
Caprolactam	UG/KG	0	0%		0	0	23						
Carbazole	UG/KG	77000	57%		0	27	47	77000	150	5100 J	9300 J	47000	780 J
Chrysene	UG/KG	150000	81%	400	37	56	69	90000	560	20000	82000	110000	2800
Di-n-butylphthalate	UG/KG	140	6%	8100	0	4	69	70000 U	89 U	8400 U	39000 U	35000 U	900 U
Di-n-octylphthalate	UG/KG	0	0%	50000	0	0	69	70000 U	89 U	8400 U	39000 U	35000 U	900 U
Dibenz(a,h)anthracene	UG/KG	25000	58%	14	40	40	69	17000 J	83 J	3600 J	16000 J	21000 J	440 J
Dibenzofuran	UG/KG	38000	39%	6200	4	27	69	38000 J	31 J	680 J	3000 J	23000 J	110 J
Diethyl phthalate	UG/KG	0	0%	7100	0	0	69	70000 U	89 U	8400 U	39000 U	35000 U	900 U
Dimethylphthalate	UG/KG	0	0%	2000	0	0	69	70000 U	89 U	8400 U	39000 U	35000 U	900 U
Fluoranthene	UG/KG	440000	84%	50000	6	58	69	240000	480	37000	190000	270000	5300
Fluorene	UG/KG	62000	41%	50000	1	28	69	62000 J	47 J	1900 J	7300 J	39000	190 J

Table A-4A
SURFACE SOIL SAMPLE RESULTS (0-2 ft.)
SEAD-71
SEAD-59 and SEAD-71 Phase II RI Report
Seneca Army Depot Activity

Facility	SEAD-71	SEAD-71	SEAD-71	SEAD-71	SEAD-71	SEAD-71
Location ID	SS71-13	SS71-14	SS71-15	SS71-16	SS71-17	SS71-18
Maxtrix	SOIL	SOIL	SOIL	SOIL	SOIL	SOIL
Sample ID	71027	71025	71032	71021	71030	71022
Sample Depth to Top of Sample ⁽¹⁾	0	0	0	0	0	0
Sample Depth to Bottom of Sample ⁽¹⁾	0.2	0.2	0.2	0.2	0.2	0.2
Sample Date	11/21/1997	11/20/1997	11/21/1997	11/20/1997	11/21/1997	11/20/1997
QC Code	SA	SA	SA	SA	SA	SA
Study ID	RI PHASE 1 STEP 1	RI PHASE 1 STEP 1	RI PHASE 1 STEP 1	RI PHASE 1 STEP 1	RI PHASE 1 STEP 1	RI PHASE 1 STEP 1
Sample Round						

Parameter	Units	Maximum Value	Frequency of Detection	NYSDEC TAGM 4046 ⁽²⁾	Number of Exceedances	Number of Detects	Number of Analyses	Value (Q)					
								Value (Q)	Value (Q)	Value (Q)	Value (Q)	Value (Q)	Value (Q)
Hexachlorobenzene	UG/KG	0	0%	410	0	0	69	70000 U	89 U	8400 U	39000 U	35000 U	900 U
Hexachlorobutadiene	UG/KG	0	0%		0	0	69	70000 U	89 U	8400 U	39000 U	35000 U	900 U
Hexachlorocyclopentadiene	UG/KG	0	0%		0	0	47	70000 U	89 U	8400 U	39000 U	35000 U	900 U
Hexachloroethane	UG/KG	0	0%		0	0	69	70000 U	89 U	8400 U	39000 U	35000 U	900 U
Indeno(1,2,3-cd)pyrene	UG/KG	65000	70%	3200	11	48	69	38000 J	190	11000	36000 J	45000	1200
Isophorone	UG/KG	0	0%	4400	0	0	69	70000 U	89 U	8400 U	39000 U	35000 U	900 U
N-Nitrosodiphenylamine	UG/KG	0	0%		0	0	47	70000 U	89 U	8400 U	39000 U	35000 U	900 U
N-Nitrosodipropylamine	UG/KG	0	0%		0	0	47	70000 U	89 U	8400 U	39000 U	35000 U	900 U
Naphthalene	UG/KG	46000	22%	13000	1	15	69	46000 J	31 J	8400 U	39000 U	5500 J	88 J
Nitrobenzene	UG/KG	0	0%	200	0	0	69	70000 U	89 U	8400 U	39000 U	35000 U	900 U
Pentachlorophenol	UG/KG	0	0%	1000	0	0	69	170000 U	220 U	20000 U	94000 U	85000 U	2200 U
Phenanthrene	UG/KG	290000	78%	50000	5	54	69	290000	210	24000	92000	240000	2800
Phenol	UG/KG	4.5	1%	30	0	1	69	70000 U	89 U	8400 U	39000 U	35000 U	900 U
Pyrene	UG/KG	280000	81%	50000	6	56	69	200000	520	35000	170000	220000	4700
Pyridine	UG/KG	0	0%		0	0	22						
Pesticides/PCBs													
4,4'-DDD	UG/KG	240	26%	2900	0	18	69	57	4.4 U	110	53	240	3.1 J
4,4'-DDE	UG/KG	810	42%	2100	0	29	69	35 U	18	440	360	810	20
4,4'-DDT	UG/KG	1300	51%	2100	0	35	69	40	21	910	1300	1300	46
Aldrin	UG/KG	0	0%	41	0	0	69	18 U	2.3 U	22 U	20 U	18 U	1.8 U
Alpha-BHC	UG/KG	18	7%	110	0	5	69	18 U	2.3 U	22 U	20 U	18 J	1.2 J
Alpha-Chlordane	UG/KG	2	1%		0	1	69	18 U	2.3 U	22 U	20 U	18 U	1.8 U
Beta-BHC	UG/KG	35	9%	200	0	6	69	32	2.3 U	21 J	11 J	35	1.9
Delta-BHC	UG/KG	0	0%	300	0	0	69	18 U	2.3 U	22 U	20 U	18 U	1.8 U
Dieldrin	UG/KG	3.4	3%	44	0	2	69	35 U	3.4 J	42 U	39 U	35 U	3.6 U
Endosulfan I	UG/KG	15	10%	900	0	7	69	15 J	2.3 U	13 J	20 U	18 U	1.5 J
Endosulfan II	UG/KG	52	4%	900	0	3	69	35 U	4.4 U	52	39 U	35 U	3.6 U
Endosulfan sulfate	UG/KG	110	16%	1000	0	11	69	110	4.4 U	110	39 U	35 U	12
Endrin	UG/KG	120	14%	100	1	10	69	22 J	8.1	53	120	53	2.7 J
Endrin aldehyde	UG/KG	120	23%		0	16	69	22 J	5.2	110	61	53	7.8
Endrin ketone	UG/KG	180	22%		0	15	69	87	14	130	140	180	12
Gamma-BHC/Lindane	UG/KG	0	0%	60	0	0	69	18 U	2.3 U	22 U	20 U	18 U	1.8 U
Gamma-Chlordane	UG/KG	48	6%	540	0	4	69	18 U	2.3 U	22 U	22	48	1.5 J
Heptachlor	UG/KG	0	0%	100	0	0	69	18 U	2.3 U	22 U	20 U	18 U	1.8 U
Heptachlor epoxide	UG/KG	180	17%	20	4	12	69	9.8 J	2.3 U	28	24	180	3.1
Methoxychlor	UG/KG	520	16%		0	11	69	250	39	140 J	200	240	11 J
Toxaphene	UG/KG	0	0%		0	0	69	1800 U	230 U	2200 U	2000 U	1800 U	180 U
Aroclor-1016	UG/KG	0	0%		0	0	69	350 U	44 U	420 U	390 U	350 U	36 U

Table A-4A
SURFACE SOIL SAMPLE RESULTS (0-2 ft.)
SEAD-71
SEAD-59 and SEAD-71 Phase II RI Report
Seneca Army Depot Activity

Facility	SEAD-71	SEAD-71	SEAD-71	SEAD-71	SEAD-71	SEAD-71
Location ID	SS71-13	SS71-14	SS71-15	SS71-16	SS71-17	SS71-18
Maxtrix	SOIL	SOIL	SOIL	SOIL	SOIL	SOIL
Sample ID	71027	71025	71032	71021	71030	71022
Sample Depth to Top of Sample ⁽¹⁾	0	0	0	0	0	0
Sample Depth to Bottom of Sample ⁽¹⁾	0.2	0.2	0.2	0.2	0.2	0.2
Sample Date	11/21/1997	11/20/1997	11/21/1997	11/20/1997	11/21/1997	11/20/1997
QC Code	SA	SA	SA	SA	SA	SA
Study ID	RI PHASE 1 STEP 1	RI PHASE 1 STEP 1	RI PHASE 1 STEP 1	RI PHASE 1 STEP 1	RI PHASE 1 STEP 1	RI PHASE 1 STEP 1
Sample Round						

Parameter	Units	Maximum Frequency of		NYSDEC TAGM 4046 ⁽²⁾	Number of Exceedances	Number of Detects	Number of Analyses	Value (Q)					
		Value	Detection					Value (Q)	Value (Q)	Value (Q)	Value (Q)	Value (Q)	Value (Q)
Aroclor-1221	UG/KG	0	0%		0	0	69	710 U	90 U	850 U	790 U	710 U	73 U
Aroclor-1232	UG/KG	0	0%		0	0	69	350 U	44 U	420 U	390 U	350 U	36 U
Aroclor-1242	UG/KG	0	0%		0	0	69	350 U	44 U	420 U	390 U	350 U	36 U
Aroclor-1248	UG/KG	0	0%		0	0	69	350 U	44 U	420 U	390 U	350 U	36 U
Aroclor-1254	UG/KG	0	0%	10000	0	0	69	350 U	44 U	420 U	390 U	350 U	36 U
Aroclor-1260	UG/KG	200	4%	10000	0	3	69	350 U	44 U	420 U	390 U	350 U	36 U
Metals													
Aluminum	MG/KG	18000	100%	19300	0	69	69	1890	10500	4230	4690	1910	1710
Antimony	MG/KG	19.3	49%	5.9	5	34	69	0.63 UJ	0.85 UJ	1.8 J	19.3 J	0.67 UJ	0.75 J
Arsenic	MG/KG	14.6	100%	8.2	5	69	69	3.5	4.1	5.9	9.8	3.5	2.1
Barium	MG/KG	179	100%	300	0	69	69	65.1 J	58.8 J	40.4 J	179 J	127 J	20.9 J
Beryllium	MG/KG	0.88	99%	1.1	0	68	69	0.05	0.31	0.19	0.08	0.07	0.08
Cadmium	MG/KG	12.1	67%	2.3	4	46	69	0.05 UJ	0.07 UJ	12.1 J	3.1 J	0.06 UJ	1.5 J
Calcium	MG/KG	295000	100%	121000	11	69	69	190000	295000	192000	245000	221000	222000
Chromium	MG/KG	60.3	100%	29.6	5	69	69	4.2 J	16.5 J	23.1 J	33.2 J	5.3 J	21.4 J
Cobalt	MG/KG	14.6	100%	30	0	69	69	3.7	10	7.8	9.8	4.3	3.3
Copper	MG/KG	134	100%	33	21	69	69	5.9 J	19.5 J	40.3 J	134 J	7.4 J	19.8 J
Cyanide	MG/KG	0	0%	0.35	0	0	24	0.53 U	0.71 U	0.63 U	0.59 U	0.56 U	0.63 U
Iron	MG/KG	65100	100%	36500	2	69	69	6220	19600	18400	36100	6420	8260
Lead	MG/KG	3470	100%	24.8	33	69	69	11.4 J	33.3 J	212 J	3470 J	15.6 J	205 J
Magnesium	MG/KG	59300	100%	21500	6	69	69	33800	59300	11800	10800	33300	11300
Manganese	MG/KG	1330	100%	1060	1	69	69	306 J	640 J	389 J	534 J	277 J	202 J
Mercury	MG/KG	2.7	80%	0.1	10	55	69	0.05 UJ	0.07 J	0.06 UJ	2.7 J	0.05 UJ	0.05 UJ
Nickel	MG/KG	110	100%	49	2	69	69	10.7	20.8	27.3	32.6	11.1	8.7
Potassium	MG/KG	2180	100%	2380	0	69	69	903	1540	1120	1020	849	671
Selenium	MG/KG	1.8	19%	2	0	13	69	0.85 UJ	1.3 J	1.1 UJ	1.8 J	0.9 UJ	0.9 UJ
Silver	MG/KG	2.2	39%	0.75	15	27	69	0.38 UJ	0.51 UJ	0.6 J	0.44 J	0.4 UJ	0.4 UJ
Sodium	MG/KG	1040	97%	172	19	67	69	224	233	573	314	302	208
Thallium	MG/KG	2.3	26%	0.7	10	18	69	1.1 U	1.5 U	1.5 U	1.3 U	1.2 U	1.2 U
Vanadium	MG/KG	29.2	100%	150	0	69	69	6.9	17.8	20.1	17.3	7.4	8.8
Zinc	MG/KG	3660	99%	110	17	68	69	44.4 J	389 J	1810 J	351 J	43.4 J	73.1 J

Note(s):
(1) - Historical sample depths are presented (I.e. prior to 2002 TCRA)
(2) - NYSDEC Technical and Administrative Guidance Memorandum (TAGM) HWR-94-4046

U = compound was not detected
J = the reported value is an estimated concentration

Table A-4A
SURFACE SOIL SAMPLE RESULTS (0-2 ft.)
SEAD-71
SEAD-59 and SEAD-71 Phase II RI Report
Seneca Army Depot Activity

Facility	SEAD-71	SEAD-71	SEAD-71	SEAD-71	SEAD-71	SEAD-71
Location ID	SS71-13	SS71-14	SS71-15	SS71-16	SS71-17	SS71-18
Maxtrix	SOIL	SOIL	SOIL	SOIL	SOIL	SOIL
Sample ID	71027	71025	71032	71021	71030	71022
Sample Depth to Top of Sample ⁽¹⁾	0	0	0	0	0	0
Sample Depth to Bottom of Sample ⁽¹⁾	0.2	0.2	0.2	0.2	0.2	0.2
Sample Date	11/21/1997	11/20/1997	11/21/1997	11/20/1997	11/21/1997	11/20/1997
QC Code	SA	SA	SA	SA	SA	SA
Study ID	RI PHASE 1 STEP 1	RI PHASE 1 STEP 1	RI PHASE 1 STEP 1	RI PHASE 1 STEP 1	RI PHASE 1 STEP 1	RI PHASE 1 STEP 1
Sample Round						

Parameter	Units	Maximum Value	Frequency of Detection	NYSDEC TAGM 4046 ⁽²⁾	Number of Exceedances	Number of Detects	Number of Analyses	Value (Q)	Value (Q)	Value (Q)	Value (Q)	Value (Q)	Value (Q)

UJ = the compound was not detected; the associated reporting limit is approximate

R = the data was rejected in the data validating process

NJ = compound was "tentatively identified" and the associated numerical value is approximate

Table A-4A
SURFACE SOIL SAMPLE RESULTS (0-2 ft.)
SEAD-71
SEAD-59 and SEAD-71 Phase II RI Report
Seneca Army Depot Activity

Facility	SEAD-71	SEAD-71	SEAD-71	SEAD-71	SEAD-71	SEAD-71
Location ID	SS71-19	SS71-2	SS71-20	SS71-3	SS71-4	SS71-5
Maxtrix	SOIL	SOIL	SOIL	SOIL	SOIL	SOIL
Sample ID	71020	71014	71031	71015	71016	71029
Sample Depth to Top of Sample ⁽¹⁾	0	0	0	0	0	0
Sample Depth to Bottom of Sample ⁽¹⁾	0.2	0.2	0.2	0.2	0.2	0.2
Sample Date	11/20/1997	11/19/1997	11/21/1997	11/19/1997	11/19/1997	11/21/1997
QC Code	SA	SA	SA	SA	SA	SA
Study ID	RI PHASE 1 STEP 1	RI PHASE 1 STEP 1	RI PHASE 1 STEP 1	RI PHASE 1 STEP 1	RI PHASE 1 STEP 1	RI PHASE 1 STEP 1
Sample Round						

Parameter	Units	Maximum	Frequency of	NYSDEC	Number of	Number of	Number of	Value (Q)	Value (Q)	Value (Q)	Value (Q)	Value (Q)	Value (Q)
		Value	Detection	TAGM 4046 ⁽²⁾	Exceedances	Detects	Analyses						
Volatile Organics													
1,1,1-Trichloroethane	UG/KG	3	3%	800	0	2	68	13 U	15 U	13 U	12 U	12 U	11 U
1,1,2,2-Tetrachloroethane	UG/KG	0	0%	600	0	0	64	13 U	15 U	13 U	12 U	12 U	11 U
1,1,2-Trichloro-1,2,2-Trifluoroethane	UG/KG	0	0%		0	0	44						
1,1,2-Trichloroethane	UG/KG	0	0%		0	0	47	13 U	15 U	13 U	12 U	12 U	11 U
1,1-Dichloroethane	UG/KG	0	0%	200	0	0	68	13 U	15 U	13 U	12 U	12 U	11 U
1,1-Dichloroethene	UG/KG	0	0%	400	0	0	68	13 U	15 U	13 U	12 U	12 U	11 U
1,2,3-Trichloropropane	UG/KG	0	0%		0	0	21						
1,2,4-Trichlorobenzene	UG/KG	0	0%	3400	0	0	40						
1,2-Dibromo-3-chloropropane	UG/KG	0	0%		0	0	19						
1,2-Dibromoethane	UG/KG	0	0%		0	0	23						
1,2-Dichlorobenzene	UG/KG	0	0%	7900	0	0	40						
1,2-Dichloroethane	UG/KG	0	0%	100	0	0	68	13 U	15 U	13 U	12 U	12 U	11 U
1,2-Dichloroethene (total)	UG/KG	0	0%		0	0	24	13 U	15 U	13 U	12 U	12 U	11 U
1,2-Dichloropropane	UG/KG	0	0%		0	0	47	13 U	15 U	13 U	12 U	12 U	11 U
1,3-Dichlorobenzene	UG/KG	0	0%	1600	0	0	40						
1,3-Dichloropropane	UG/KG	0	0%		0	0	21						
1,4-Dichlorobenzene	UG/KG	0	0%	8500	0	0	40						
Acetone	UG/KG	74	13%	200	0	9	68	13 U	8 J	13 U	12 U	12 U	11 U
Benzene	UG/KG	2	3%	60	0	2	68	13 U	15 U	13 U	12 U	12 U	11 U
Bromodichloromethane	UG/KG	0	0%		0	0	47	13 U	15 U	13 U	12 U	12 U	11 U
Bromoform	UG/KG	0	0%		0	0	47	13 U	15 U	13 U	12 U	12 U	11 U
Carbon disulfide	UG/KG	5	4%	2700	0	3	68	13 U	15 U	13 U	12 U	12 U	11 U
Carbon tetrachloride	UG/KG	0	0%	600	0	0	68	13 U	15 U	13 U	12 U	12 U	11 U
Chlorobenzene	UG/KG	0	0%	1700	0	0	68	13 U	15 U	13 U	12 U	12 U	11 U
Chlorodibromomethane	UG/KG	0	0%		0	0	68	13 U	15 U	13 U	12 U	12 U	11 U
Chloroethane	UG/KG	0	0%	1900	0	0	68	13 U	15 U	13 U	12 U	12 U	11 U
Chloroform	UG/KG	0	0%	300	0	0	68	13 U	15 U	13 U	12 U	12 U	11 U
Cis-1,2-Dichloroethene	UG/KG	0	0%		0	0	23						
Cis-1,3-Dichloropropene	UG/KG	0	0%		0	0	47	13 U	15 U	13 U	12 U	12 U	11 U
Cyclohexane	UG/KG	4	9%		0	2	23						
Dichlorodifluoromethane	UG/KG	0	0%		0	0	23						
Ethyl benzene	UG/KG	4	3%	5500	0	2	68	13 U	15 U	4 J	12 U	12 U	11 U
Isopropylbenzene	UG/KG	0	0%		0	0	23						
Meta/Para Xylene	UG/KG	0	0%		0	0	21						
Methyl Acetate	UG/KG	0	0%		0	0	23						
Methyl Tertbutyl Ether	UG/KG	0	0%		0	0	23						
Methyl bromide	UG/KG	0	0%		0	0	47	13 U	15 U	13 U	12 U	12 U	11 U

Table A-4A
SURFACE SOIL SAMPLE RESULTS (0-2 ft.)
SEAD-71
SEAD-59 and SEAD-71 Phase II RI Report
Seneca Army Depot Activity

Facility	SEAD-71	SEAD-71	SEAD-71	SEAD-71	SEAD-71	SEAD-71
Location ID	SS71-19	SS71-2	SS71-20	SS71-3	SS71-4	SS71-5
Maxtrix	SOIL	SOIL	SOIL	SOIL	SOIL	SOIL
Sample ID	71020	71014	71031	71015	71016	71029
Sample Depth to Top of Sample ⁽¹⁾	0	0	0	0	0	0
Sample Depth to Bottom of Sample ⁽¹⁾	0.2	0.2	0.2	0.2	0.2	0.2
Sample Date	11/20/1997	11/19/1997	11/21/1997	11/19/1997	11/19/1997	11/21/1997
QC Code	SA	SA	SA	SA	SA	SA
Study ID	RI PHASE 1 STEP 1	RI PHASE 1 STEP 1	RI PHASE 1 STEP 1	RI PHASE 1 STEP 1	RI PHASE 1 STEP 1	RI PHASE 1 STEP 1
Sample Round						

Parameter	Units	Maximum Frequency of		NYSDEC TAGM 4046 ⁽²⁾	Number of Exceedances	Number of Detects	Number of Analyses	Value (Q)	Value (Q)	Value (Q)	Value (Q)	Value (Q)	Value (Q)
		Value	Detection										
Methyl butyl ketone	UG/KG	0	0%		0	0	47	13 U	15 U	13 U	12 U	12 U	11 U
Methyl chloride	UG/KG	0	0%		0	0	47	13 U	15 U	13 U	12 U	12 U	11 U
Methyl cyclohexane	UG/KG	6	13%		0	3	23						
Methyl ethyl ketone	UG/KG	0	0%	300	0	0	68	13 U	15 U	13 U	12 U	12 U	11 U
Methyl isobutyl ketone	UG/KG	0	0%	1000	0	0	68	13 U	15 U	13 U	12 U	12 U	11 U
Methylene chloride	UG/KG	11	12%	100	0	8	68	13 U	15 U	13 U	12 U	12 U	11 U
Ortho Xylene	UG/KG	0	0%		0	0	21						
Styrene	UG/KG	1	2%		0	1	47	13 U	15 U	1 J	12 U	12 U	11 U
Tetrachloroethene	UG/KG	33	1%	1400	0	1	68	13 U	15 U	13 U	12 U	12 U	11 U
Toluene	UG/KG	16	16%	1500	0	11	68	13 U	15 U	7 J	12 U	12 U	5 J
Total BTEX	MG/KG	11.6	100%		0	1	1						
Total Xylenes	UG/KG	11	11%	1200	0	5	44	13 U	15 U	9 J	12 U	12 U	11 U
Trans-1,2-Dichloroethene	UG/KG	0	0%	300	0	0	44						
Trans-1,3-Dichloropropene	UG/KG	0	0%		0	0	47	13 U	15 U	13 U	12 U	12 U	11 U
Trichloroethene	UG/KG	0	0%	700	0	0	68	13 U	15 U	13 U	12 U	12 U	11 U
Trichlorofluoromethane	UG/KG	1	4%		0	1	23						
Vinyl chloride	UG/KG	0	0%	200	0	0	68	13 U	15 U	13 U	12 U	12 U	11 U
Semivolatile Organics													
1,1'-Biphenyl	UG/KG	0	0%		0	0	23						
1,2,4-Trichlorobenzene	UG/KG	0	0%	3400	0	0	24	2800 U	880 U	800 U	170 U	80 U	1500 U
1,2-Dichlorobenzene	UG/KG	0	0%	7900	0	0	24	2800 U	880 U	800 U	170 U	80 U	1500 U
1,3-Dichlorobenzene	UG/KG	0	0%	1600	0	0	24	2800 U	880 U	800 U	170 U	80 U	1500 U
1,4-Dichlorobenzene	UG/KG	0	0%	8500	0	0	24	2800 U	880 U	800 U	170 U	80 U	1500 U
2,2'-oxybis(1-Chloropropane)	UG/KG	0	0%		0	0	27						
2,4,5-Trichlorophenol	UG/KG	0	0%	100	0	0	69	6800 U	2100 U	2000 U	410 U	190 U	3600 U
2,4,6-Trichlorophenol	UG/KG	0	0%		0	0	69	2800 U	880 U	800 U	170 U	80 U	1500 U
2,4-Dichlorophenol	UG/KG	0	0%	400	0	0	69	2800 U	880 U	800 U	170 U	80 U	1500 U
2,4-Dimethylphenol	UG/KG	0	0%		0	0	47	2800 U	880 U	800 U	170 U	80 U	1500 U
2,4-Dinitrophenol	UG/KG	0	0%	200	0	0	69	6800 U	2100 U	2000 U	410 U	190 U	3600 U
2,4-Dinitrotoluene	UG/KG	880	1%		0	1	69	2800 U	880 U	800 U	170 U	80 U	1500 U
2,6-Dinitrotoluene	UG/KG	0	0%	1000	0	0	69	2800 U	880 U	800 U	170 U	80 U	1500 U
2-Chloronaphthalene	UG/KG	0	0%		0	0	47	2800 U	880 U	800 U	170 U	80 U	1500 U
2-Chlorophenol	UG/KG	0	0%	800	0	0	69	2800 U	880 U	800 U	170 U	80 U	1500 U
2-Methylnaphthalene	UG/KG	19000	22%	36400	0	15	69	2800 U	880 U	800 U	15 J	9.4 J	1500 U
2-Methylphenol	UG/KG	0	0%	100	0	0	69	2800 U	880 U	800 U	170 U	80 U	1500 U
2-Nitroaniline	UG/KG	0	0%	430	0	0	69	6800 U	2100 U	2000 U	410 U	190 U	3600 U
2-Nitrophenol	UG/KG	0	0%	330	0	0	69	2800 U	880 U	800 U	170 U	80 U	1500 U
3,3'-Dichlorobenzidine	UG/KG	0	0%		0	0	69	2800 U	880 U	800 U	170 U	80 U	1500 U

Table A-4A
SURFACE SOIL SAMPLE RESULTS (0-2 ft.)
SEAD-71
SEAD-59 and SEAD-71 Phase II RI Report
Seneca Army Depot Activity

Facility	SEAD-71	SEAD-71	SEAD-71	SEAD-71	SEAD-71	SEAD-71
Location ID	SS71-19	SS71-2	SS71-20	SS71-3	SS71-4	SS71-5
Maxtrix	SOIL	SOIL	SOIL	SOIL	SOIL	SOIL
Sample ID	71020	71014	71031	71015	71016	71029
Sample Depth to Top of Sample ⁽¹⁾	0	0	0	0	0	0
Sample Depth to Bottom of Sample ⁽¹⁾	0.2	0.2	0.2	0.2	0.2	0.2
Sample Date	11/20/1997	11/19/1997	11/21/1997	11/19/1997	11/19/1997	11/21/1997
QC Code	SA	SA	SA	SA	SA	SA
Study ID	RI PHASE 1 STEP 1	RI PHASE 1 STEP 1	RI PHASE 1 STEP 1	RI PHASE 1 STEP 1	RI PHASE 1 STEP 1	RI PHASE 1 STEP 1
Sample Round						

Parameter	Units	Maximum Frequency of		NYSDEC TAGM 4046 ⁽²⁾	Number of Exceedances	Number of Detects	Number of Analyses	Value (Q)	Value (Q)	Value (Q)	Value (Q)	Value (Q)	Value (Q)
		Value	Detection										
3-Nitroaniline	UG/KG	0	0%	500	0	0	69	6800 U	2100 U	2000 U	410 U	190 U	3600 U
4,6-Dinitro-2-methylphenol	UG/KG	0	0%		0	0	47	6800 U	2100 U	2000 U	410 U	190 U	3600 U
4-Bromophenyl phenyl ether	UG/KG	0	0%		0	0	47	2800 U	880 U	800 U	170 U	80 U	1500 U
4-Chloro-3-methylphenol	UG/KG	0	0%	240	0	0	69	2800 U	880 U	800 U	170 U	80 U	1500 U
4-Chloroaniline	UG/KG	0	0%	220	0	0	69	2800 U	880 U	800 U	170 U	80 U	1500 U
4-Chlorophenyl phenyl ether	UG/KG	0	0%		0	0	47	2800 U	880 U	800 U	170 U	80 U	1500 U
4-Methylphenol	UG/KG	0	0%	900	0	0	69	2800 U	880 U	800 U	170 U	80 U	1500 U
4-Nitroaniline	UG/KG	75	2%		0	1	47	6800 U	2100 U	2000 U	410 U	190 U	3600 U
4-Nitrophenol	UG/KG	0	0%	100	0	0	69	6800 U	2100 U	2000 U	410 U	190 U	3600 U
Acenaphthene	UG/KG	42000	42%	50000	0	29	69	510 J	69 J	160 J	52 J	5.5 J	290 J
Acenaphthylene	UG/KG	1800	28%	41000	0	19	69	2800 U	880 U	800 U	170 U	80 U	1500 U
Acetophenone	UG/KG	0	0%		0	0	23						
Aniline	UG/KG	0	0%		0	0	22						
Anthracene	UG/KG	100000	59%	50000	3	41	69	1000 J	170 J	440 J	120 J	12 J	590 J
Atrazine	UG/KG	0	0%		0	0	23						
Benzaldehyde	UG/KG	0	0%		0	0	23						
Benzo(a)anthracene	UG/KG	150000	77%	224	40	53	69	4500	1100	2100	570	70 J	3200
Benzo(a)pyrene	UG/KG	120000	77%	61	47	53	69	4400	1300	2000	540	83	3400
Benzo(b)fluoranthene	UG/KG	88000	78%	1100	23	54	69	4600	1200	1900	950	130	4300
Benzo(ghi)perylene	UG/KG	62000	70%	50000	1	48	69	2600 J	820 J	1200	310	69 J	2300
Benzo(k)fluoranthene	UG/KG	130000	61%	1100	20	42	69	4700	1600	2000	170 U	80 U	4500
Benzoic Acid	UG/KG	0	0%	2700	0	0	22						
Bis(2-Chloroethoxy)methane	UG/KG	0	0%		0	0	47	2800 U	880 U	800 U	170 U	80 U	1500 U
Bis(2-Chloroethyl)ether	UG/KG	0	0%		0	0	47	2800 U	880 U	800 U	170 U	80 U	1500 U
Bis(2-Chloroisopropyl)ether	UG/KG	0	0%		0	0	20	2800 U	880 U	800 U	170 U	80 U	1500 U
Bis(2-Ethylhexyl)phthalate	UG/KG	140	9%	50000	0	6	69	2800 U	880 U	800 U	170 U	80 U	1500 U
Butylbenzylphthalate	UG/KG	0	0%	50000	0	0	69	2800 U	880 U	800 U	170 U	80 U	1500 U
Caprolactam	UG/KG	0	0%		0	0	23						
Carbazole	UG/KG	77000	57%		0	27	47	1700 J	350 J	680 J	160 J	15 J	1300 J
Chrysene	UG/KG	150000	81%	400	37	56	69	5500	1600	2400	660	80	6200
Di-n-butylphthalate	UG/KG	140	6%	8100	0	4	69	140 J	880 U	800 U	170 U	80 U	1500 U
Di-n-octylphthalate	UG/KG	0	0%	50000	0	0	69	2800 U	880 U	800 U	170 U	80 U	1500 U
Dibenz(a,h)anthracene	UG/KG	25000	58%	14	40	40	69	1100 J	300 J	430 J	120 J	29 J	760 J
Dibenzofuran	UG/KG	38000	39%	6200	4	27	69	270 J	64 J	89 J	22 J	80 U	190 J
Diethyl phthalate	UG/KG	0	0%	7100	0	0	69	2800 U	880 U	800 U	170 U	80 U	1500 U
Dimethylphthalate	UG/KG	0	0%	2000	0	0	69	2800 U	880 U	800 U	170 U	80 U	1500 U
Fluoranthene	UG/KG	440000	84%	50000	6	58	69	12000	3000	4300	1200	140	12000
Fluorene	UG/KG	62000	41%	50000	1	28	69	570 J	67 J	160 J	36 J	4.7 J	290 J

Table A-4A
SURFACE SOIL SAMPLE RESULTS (0-2 ft.)
SEAD-71
SEAD-59 and SEAD-71 Phase II RI Report
Seneca Army Depot Activity

Facility	SEAD-71	SEAD-71	SEAD-71	SEAD-71	SEAD-71	SEAD-71
Location ID	SS71-19	SS71-2	SS71-20	SS71-3	SS71-4	SS71-5
Maxtrix	SOIL	SOIL	SOIL	SOIL	SOIL	SOIL
Sample ID	71020	71014	71031	71015	71016	71029
Sample Depth to Top of Sample ⁽¹⁾	0	0	0	0	0	0
Sample Depth to Bottom of Sample ⁽¹⁾	0.2	0.2	0.2	0.2	0.2	0.2
Sample Date	11/20/1997	11/19/1997	11/21/1997	11/19/1997	11/19/1997	11/21/1997
QC Code	SA	SA	SA	SA	SA	SA
Study ID	RI PHASE 1 STEP 1	RI PHASE 1 STEP 1	RI PHASE 1 STEP 1	RI PHASE 1 STEP 1	RI PHASE 1 STEP 1	RI PHASE 1 STEP 1
Sample Round						

Parameter	Units	Maximum	Frequency of	NYSDEC	Number of	Number of	Number of	Value (Q)	Value (Q)	Value (Q)	Value (Q)	Value (Q)	Value (Q)
		Value	Detection	TAGM 4046 ⁽²⁾	Exceedances	Detects	Analyses						
Hexachlorobenzene	UG/KG	0	0%	410	0	0	69	2800 U	880 U	800 U	170 U	80 U	1500 U
Hexachlorobutadiene	UG/KG	0	0%		0	0	69	2800 U	880 U	800 U	170 U	80 U	1500 U
Hexachlorocyclopentadiene	UG/KG	0	0%		0	0	47	2800 U	880 U	800 U	170 U	80 U	1500 U
Hexachloroethane	UG/KG	0	0%		0	0	69	2800 U	880 U	800 U	170 U	80 U	1500 U
Indeno(1,2,3-cd)pyrene	UG/KG	65000	70%	3200	11	48	69	2500 J	780 J	1100	310	57 J	2100
Isophorone	UG/KG	0	0%	4400	0	0	69	2800 U	880 U	800 U	170 U	80 U	1500 U
N-Nitrosodiphenylamine	UG/KG	0	0%		0	0	47	2800 U	880 U	800 U	170 U	80 U	1500 U
N-Nitrosodipropylamine	UG/KG	0	0%		0	0	47	2800 U	880 U	800 U	170 U	80 U	1500 U
Naphthalene	UG/KG	46000	22%	13000	1	15	69	2800 U	880 U	800 U	11 J	10 J	1500 U
Nitrobenzene	UG/KG	0	0%	200	0	0	69	2800 U	880 U	800 U	170 U	80 U	1500 U
Pentachlorophenol	UG/KG	0	0%	1000	0	0	69	6800 U	2100 U	2000 U	410 U	190 U	3600 U
Phenanthrene	UG/KG	290000	78%	50000	5	54	69	8300	1400	2600	530	50 J	5700
Phenol	UG/KG	4.5	1%	30	0	1	69	2800 U	880 U	800 U	170 U	80 U	1500 U
Pyrene	UG/KG	280000	81%	50000	6	56	69	11000	2300	3900	950	110	9400
Pyridine	UG/KG	0	0%		0	0	22						
Pesticides/PCBs													
4,4'-DDD	UG/KG	240	26%	2900	0	18	69	40 J	2.8 J	40 U	4.2 U	3.2 J	37 U
4,4'-DDE	UG/KG	810	42%	2100	0	29	69	390	44	86	21	19	45
4,4'-DDT	UG/KG	1300	51%	2100	0	35	69	960	53	100	19	16	37 U
Aldrin	UG/KG	0	0%	41	0	0	69	22 U	2.3 U	21 U	2.2 U	2 U	19 U
Alpha-BHC	UG/KG	18	7%	110	0	5	69	22 U	1.9 J	21 U	2.2 U	2 U	14 J
Alpha-Chlordane	UG/KG	2	1%		0	1	69	22 U	2.3 U	21 U	2.2 U	2 U	19 U
Beta-BHC	UG/KG	35	9%	200	0	6	69	22 U	2.3 U	21 U	2.2 U	2 U	19 U
Delta-BHC	UG/KG	0	0%	300	0	0	69	22 U	2.3 U	21 U	2.2 U	2 U	19 U
Dieldrin	UG/KG	3.4	3%	44	0	2	69	42 U	3 J	40 U	4.2 U	4 U	37 U
Endosulfan I	UG/KG	15	10%	900	0	7	69	22 U	2.3 U	21 U	2.2 U	2 U	19 U
Endosulfan II	UG/KG	52	4%	900	0	3	69	42 U	4.4 U	40 U	4.2 U	4 U	37 U
Endosulfan sulfate	UG/KG	110	16%	1000	0	11	69	31 J	4.4	40 U	4 J	4 U	37 U
Endrin	UG/KG	120	14%	100	1	10	69	42 U	2.4 J	40 U	4.2 U	4 U	37 U
Endrin aldehyde	UG/KG	120	23%		0	16	69	36 J	4.7	40 U	8.3	4	37 U
Endrin ketone	UG/KG	180	22%		0	15	69	26 J	6.6	40 U	6.4	4 U	23 J
Gamma-BHC/Lindane	UG/KG	0	0%	60	0	0	69	22 U	2.3 U	21 U	2.2 U	2 U	19 U
Gamma-Chlordane	UG/KG	48	6%	540	0	4	69	22 U	2.3 U	21 U	2.2 U	2 U	19 U
Heptachlor	UG/KG	0	0%	100	0	0	69	22 U	2.3 U	21 U	2.2 U	2 U	19 U
Heptachlor epoxide	UG/KG	180	17%	20	4	12	69	19 J	6.4	21 U	2.2 U	1.5 J	19 U
Methoxychlor	UG/KG	520	16%		0	11	69	220 U	23 U	210 U	22 U	20 U	520
Toxaphene	UG/KG	0	0%		0	0	69	2200 U	230 U	2100 U	220 U	200 U	1900 U
Aroclor-1016	UG/KG	0	0%		0	0	69	420 U	44 U	400 U	42 U	40 U	370 U

Table A-4A
SURFACE SOIL SAMPLE RESULTS (0-2 ft.)
SEAD-71
SEAD-59 and SEAD-71 Phase II RI Report
Seneca Army Depot Activity

Facility	SEAD-71	SEAD-71	SEAD-71	SEAD-71	SEAD-71	SEAD-71
Location ID	SS71-19	SS71-2	SS71-20	SS71-3	SS71-4	SS71-5
Maxtrix	SOIL	SOIL	SOIL	SOIL	SOIL	SOIL
Sample ID	71020	71014	71031	71015	71016	71029
Sample Depth to Top of Sample ⁽¹⁾	0	0	0	0	0	0
Sample Depth to Bottom of Sample ⁽¹⁾	0.2	0.2	0.2	0.2	0.2	0.2
Sample Date	11/20/1997	11/19/1997	11/21/1997	11/19/1997	11/19/1997	11/21/1997
QC Code	SA	SA	SA	SA	SA	SA
Study ID	RI PHASE 1 STEP 1	RI PHASE 1 STEP 1	RI PHASE 1 STEP 1	RI PHASE 1 STEP 1	RI PHASE 1 STEP 1	RI PHASE 1 STEP 1
Sample Round						

Parameter	Units	Maximum Frequency of		NYSDEC TAGM 4046 ⁽²⁾	Number of Exceedances	Number of Detects	Number of Analyses	Value (Q)	Value (Q)	Value (Q)	Value (Q)	Value (Q)	Value (Q)
		Value	Detection										
Aroclor-1221	UG/KG	0	0%		0	0	69	850 U	89 U	820 U	86 U	81 U	750 U
Aroclor-1232	UG/KG	0	0%		0	0	69	420 U	44 U	400 U	42 U	40 U	370 U
Aroclor-1242	UG/KG	0	0%		0	0	69	420 U	44 U	400 U	42 U	40 U	370 U
Aroclor-1248	UG/KG	0	0%		0	0	69	420 U	44 U	400 U	42 U	40 U	370 U
Aroclor-1254	UG/KG	0	0%	10000	0	0	69	420 U	44 U	400 U	42 U	40 U	370 U
Aroclor-1260	UG/KG	200	4%	10000	0	3	69	420 U	44 U	400 U	42 U	40 U	370 U
Metals													
Aluminum	MG/KG	18000	100%	19300	0	69	69	12400	14000	10600	12500	13400	2060
Antimony	MG/KG	19.3	49%	5.9	5	34	69	1.9 J	1 J	0.77 UJ	0.85 UJ	0.82 UJ	5.2 J
Arsenic	MG/KG	14.6	100%	8.2	5	69	69	11.5	6.1	6.1	4.6	4.7	9.5
Barium	MG/KG	179	100%	300	0	69	69	110 J	76.5 J	111 J	75.4 J	76.9 J	42.1 J
Beryllium	MG/KG	0.88	99%	1.1	0	68	69	0.36	0.46	0.52	0.41	0.44	0.02 U
Cadmium	MG/KG	12.1	67%	2.3	4	46	69	3.9 J	0.08 UJ	0.62 J	0.07 UJ	0.07 UJ	0.07 UJ
Calcium	MG/KG	295000	100%	121000	11	69	69	8780	8370	13800	27100	43200	204000
Chromium	MG/KG	60.3	100%	29.6	5	69	69	60.3 J	21 J	31.9 J	18 J	19.5 J	39.9 J
Cobalt	MG/KG	14.6	100%	30	0	69	69	12.4	11.1	9.7	9.4	11.2	7.8
Copper	MG/KG	134	100%	33	21	69	69	95.6 J	55 J	98.7 J	40.5 J	24.9 J	48.3 J
Cyanide	MG/KG	0	0%	0.35	0	0	24	0.64 U	0.68 U	0.7 U	0.73 U	0.61 U	0.58 U
Iron	MG/KG	65100	100%	36500	2	69	69	34300	25900	25900	22800	24900	65100
Lead	MG/KG	3470	100%	24.8	33	69	69	57.2 J	171 J	346 J	90.8 J	30.1 J	148 J
Magnesium	MG/KG	59300	100%	21500	6	69	69	4750	5570	4490	8250	10200	23200
Manganese	MG/KG	1330	100%	1060	1	69	69	660 J	602 J	523 J	482 J	510 J	520 J
Mercury	MG/KG	2.7	80%	0.1	10	55	69	0.06 UJ	0.09 J	0.07 J	0.06 UJ	0.05 UJ	0.05 UJ
Nickel	MG/KG	110	100%	49	2	69	69	98.8	28.3	27.7	25.1	30.6	33.6
Potassium	MG/KG	2180	100%	2380	0	69	69	1610	2070	1700	1960	1810	918
Selenium	MG/KG	1.8	19%	2	0	13	69	1.5 J	1.4 J	1.3 J	1.1 UJ	1.1 UJ	1.7 J
Silver	MG/KG	2.2	39%	0.75	15	27	69	0.69 J	0.54 UJ	0.63 J	0.51 UJ	0.49 UJ	0.46 UJ
Sodium	MG/KG	1040	97%	172	19	67	69	514	176	344	226	251	1040
Thallium	MG/KG	2.3	26%	0.7	10	18	69	1.5 U	1.6 U	1.4 U	1.5 U	1.5 U	1.4 U
Vanadium	MG/KG	29.2	100%	15.0	0	69	69	22.3	23.9	19.2	20	19.6	9.2
Zinc	MG/KG	3660	99%	110	17	68	69	1790 J	144 J	525 J	105 J	352 UJ	3660 J

Note(s):
(1) - Historical sample depths are presented (I.e. prior to 2002 TCRA)
(2) - NYSDEC Technical and Administrative Guidance Memorandum (TAGM) HWR-94-4046

U = compound was not detected
J = the reported value is an estimated concentration

Table A-4A
SURFACE SOIL SAMPLE RESULTS (0-2 ft.)
SEAD-71
SEAD-59 and SEAD-71 Phase II RI Report
Seneca Army Depot Activity

Facility	SEAD-71	SEAD-71	SEAD-71	SEAD-71	SEAD-71	SEAD-71
Location ID	SS71-19	SS71-2	SS71-20	SS71-3	SS71-4	SS71-5
Maxtrix	SOIL	SOIL	SOIL	SOIL	SOIL	SOIL
Sample ID	71020	71014	71031	71015	71016	71029
Sample Depth to Top of Sample ⁽¹⁾	0	0	0	0	0	0
Sample Depth to Bottom of Sample ⁽¹⁾	0.2	0.2	0.2	0.2	0.2	0.2
Sample Date	11/20/1997	11/19/1997	11/21/1997	11/19/1997	11/19/1997	11/21/1997
QC Code	SA	SA	SA	SA	SA	SA
Study ID	RI PHASE 1 STEP 1	RI PHASE 1 STEP 1	RI PHASE 1 STEP 1	RI PHASE 1 STEP 1	RI PHASE 1 STEP 1	RI PHASE 1 STEP 1
Sample Round						

Parameter	Units	Maximum Value	Frequency of Detection	NYSDEC TAGM 4046 ⁽²⁾	Number of Exceedances	Number of Detects	Number of Analyses	Value (Q)	Value (Q)	Value (Q)	Value (Q)	Value (Q)	Value (Q)

UJ = the compound was not detected; the associated reporting limit is approximate

R = the data was rejected in the data validating process

NJ = compound was "tentatively identified" and the associated numerical value is approximate

Table A-4A
SURFACE SOIL SAMPLE RESULTS (0-2 ft.)
SEAD-71
SEAD-59 and SEAD-71 Phase II RI Report
Seneca Army Depot Activity

Facility	SEAD-71	SEAD-71	SEAD-71	SEAD-71	SEAD-71	SEAD-71
Location ID	SS71-6	SS71-8	SS71-9	TP71-2	TP71-2	TP71-2
Maxtrix	SOIL	SOIL	SOIL	SOIL	SOIL	SOIL
Sample ID	71028	71019	71018	TP71-2-1	TP71-2-2	TP71-2-4
Sample Depth to Top of Sample ⁽¹⁾	0	0	0	1	2	2
Sample Depth to Bottom of Sample ⁽¹⁾	0.2	0.2	0.2	1	2	2
Sample Date	11/21/1997	11/19/1997	11/19/1997	6/7/1994	6/7/1994	6/7/1994
QC Code	SA	SA	SA	SA	SA	SA
Study ID	RI PHASE 1 STEP 1	RI PHASE 1 STEP 1	RI PHASE 1 STEP 1	ESI	ESI	ESI
Sample Round						

Parameter	Units	Maximum Frequency of		NYSDEC TAGM 4046 ⁽²⁾	Number of Exceedances	Number of Detects	Number of Analyses	Value (Q)	Value (Q)	Value (Q)	Value (Q)	Value (Q)	Value (Q)
		Value	Detection										
Volatile Organics													
1,1,1-Trichloroethane	UG/KG	3	3%	800	0	2	68	11 U	12 U	12 U	11 U	11 U	12 U
1,1,2,2-Tetrachloroethane	UG/KG	0	0%	600	0	0	64	11 U	12 U	12 U	11 U	11 U	12 U
1,1,2-Trichloro-1,2,2-Trifluoroethane	UG/KG	0	0%		0	0	44						
1,1,2-Trichloroethane	UG/KG	0	0%		0	0	47	11 U	12 U	12 U	11 U	11 U	12 U
1,1-Dichloroethane	UG/KG	0	0%	200	0	0	68	11 U	12 U	12 U	11 U	11 U	12 U
1,1-Dichloroethene	UG/KG	0	0%	400	0	0	68	11 U	12 U	12 U	11 U	11 U	12 U
1,2,3-Trichloropropane	UG/KG	0	0%		0	0	21						
1,2,4-Trichlorobenzene	UG/KG	0	0%	3400	0	0	40						
1,2-Dibromo-3-chloropropane	UG/KG	0	0%		0	0	19						
1,2-Dibromoethane	UG/KG	0	0%		0	0	23						
1,2-Dichlorobenzene	UG/KG	0	0%	7900	0	0	40						
1,2-Dichloroethane	UG/KG	0	0%	100	0	0	68	11 U	12 U	12 U	11 U	11 U	12 U
1,2-Dichloroethene (total)	UG/KG	0	0%		0	0	24	11 U	12 U	12 U	11 U	11 U	12 U
1,2-Dichloropropane	UG/KG	0	0%		0	0	47	11 U	12 U	12 U	11 U	11 U	12 U
1,3-Dichlorobenzene	UG/KG	0	0%	1600	0	0	40						
1,3-Dichloropropane	UG/KG	0	0%		0	0	21						
1,4-Dichlorobenzene	UG/KG	0	0%	8500	0	0	40						
Acetone	UG/KG	74	13%	200	0	9	68	11 U	12 U	12 U	11 U	11 U	12 U
Benzene	UG/KG	2	3%	60	0	2	68	11 U	12 U	12 U	11 U	11 U	12 U
Bromodichloromethane	UG/KG	0	0%		0	0	47	11 U	12 U	12 U	11 U	11 U	12 U
Bromoform	UG/KG	0	0%		0	0	47	11 U	12 U	12 U	11 U	11 U	12 U
Carbon disulfide	UG/KG	5	4%	2700	0	3	68	11 U	12 U	12 U	11 U	11 U	12 U
Carbon tetrachloride	UG/KG	0	0%	600	0	0	68	11 U	12 U	12 U	11 U	11 U	12 U
Chlorobenzene	UG/KG	0	0%	1700	0	0	68	11 U	12 U	12 U	11 U	11 U	12 U
Chlorodibromomethane	UG/KG	0	0%		0	0	68	11 U	12 U	12 U	11 U	11 U	12 U
Chloroethane	UG/KG	0	0%	1900	0	0	68	11 U	12 U	12 U	11 U	11 U	12 U
Chloroform	UG/KG	0	0%	300	0	0	68	11 U	12 U	12 U	11 U	11 U	12 U
Cis-1,2-Dichloroethene	UG/KG	0	0%		0	0	23						
Cis-1,3-Dichloropropene	UG/KG	0	0%		0	0	47	11 U	12 U	12 U	11 U	11 U	12 U
Cyclohexane	UG/KG	4	9%		0	2	23						
Dichlorodifluoromethane	UG/KG	0	0%		0	0	23						
Ethyl benzene	UG/KG	4	3%	5500	0	2	68	11 U	12 U	12 U	11 U	11 U	12 U
Isopropylbenzene	UG/KG	0	0%		0	0	23						
Meta/Para Xylene	UG/KG	0	0%		0	0	21						
Methyl Acetate	UG/KG	0	0%		0	0	23						
Methyl Tertbutyl Ether	UG/KG	0	0%		0	0	23						
Methyl bromide	UG/KG	0	0%		0	0	47	11 U	12 U	12 U	11 U	11 U	12 U

Table A-4A
SURFACE SOIL SAMPLE RESULTS (0-2 ft.)
SEAD-71
SEAD-59 and SEAD-71 Phase II RI Report
Seneca Army Depot Activity

Facility	SEAD-71	SEAD-71	SEAD-71	SEAD-71	SEAD-71	SEAD-71
Location ID	SS71-6	SS71-8	SS71-9	TP71-2	TP71-2	TP71-2
Maxtrix	SOIL	SOIL	SOIL	SOIL	SOIL	SOIL
Sample ID	71028	71019	71018	TP71-2-1	TP71-2-2	TP71-2-4
Sample Depth to Top of Sample ⁽¹⁾	0	0	0	1	2	2
Sample Depth to Bottom of Sample ⁽¹⁾	0.2	0.2	0.2	1	2	2
Sample Date	11/21/1997	11/19/1997	11/19/1997	6/7/1994	6/7/1994	6/7/1994
QC Code	SA	SA	SA	SA	SA	SA
Study ID	RI PHASE 1 STEP 1	RI PHASE 1 STEP 1	RI PHASE 1 STEP 1	ESI	ESI	ESI
Sample Round						

Parameter	Units	Maximum Frequency of		NYSDEC TAGM 4046 ⁽²⁾	Number of Exceedances	Number of Detects	Number of Analyses	Value (Q)	Value (Q)	Value (Q)	Value (Q)	Value (Q)	Value (Q)
		Value	Detection										
Methyl butyl ketone	UG/KG	0	0%		0	0	47	11 U	12 U	12 U	11 U	11 U	12 U
Methyl chloride	UG/KG	0	0%		0	0	47	11 U	12 U	12 U	11 U	11 U	12 U
Methyl cyclohexane	UG/KG	6	13%		0	3	23						
Methyl ethyl ketone	UG/KG	0	0%	300	0	0	68	11 U	12 U	12 U	11 U	11 U	12 U
Methyl isobutyl ketone	UG/KG	0	0%	1000	0	0	68	11 U	12 U	12 U	11 U	11 U	12 U
Methylene chloride	UG/KG	11	12%	100	0	8	68	11 U	12 U	12 U	2 J	2 J	11 J
Ortho Xylene	UG/KG	0	0%		0	0	21						
Styrene	UG/KG	1	2%		0	1	47	11 U	12 U	12 U	11 U	11 U	12 U
Tetrachloroethene	UG/KG	33	1%	1400	0	1	68	11 U	12 U	12 U	11 U	11 U	12 U
Toluene	UG/KG	16	16%	1500	0	11	68	11 U	12 U	12 U	11 U	11 U	12 U
Total BTEX	MG/KG	11.6	100%		0	1	1						
Total Xylenes	UG/KG	11	11%	1200	0	5	44	11 U	12 U	12 U	11 U	11 U	12 U
Trans-1,2-Dichloroethene	UG/KG	0	0%	300	0	0	44						
Trans-1,3-Dichloropropene	UG/KG	0	0%		0	0	47	11 U	12 U	12 U	11 U	11 U	12 U
Trichloroethene	UG/KG	0	0%	700	0	0	68	11 U	12 U	12 U	11 U	11 U	12 U
Trichlorofluoromethane	UG/KG	1	4%		0	1	23						
Vinyl chloride	UG/KG	0	0%	200	0	0	68	11 U	12 U	12 U	11 U	11 U	12 U
Semivolatile Organics													
1,1'-Biphenyl	UG/KG	0	0%		0	0	23						
1,2,4-Trichlorobenzene	UG/KG	0	0%	3400	0	0	24	18000 U	430 U	89 U	1500 U	380 U	380 U
1,2-Dichlorobenzene	UG/KG	0	0%	7900	0	0	24	18000 U	430 U	89 U	1500 U	380 U	380 U
1,3-Dichlorobenzene	UG/KG	0	0%	1600	0	0	24	18000 U	430 U	89 U	1500 U	380 U	380 U
1,4-Dichlorobenzene	UG/KG	0	0%	8500	0	0	24	18000 U	430 U	89 U	1500 U	380 U	380 U
2,2'-oxybis(1-Chloropropane)	UG/KG	0	0%		0	0	27				1500 U	380 U	380 U
2,4,5-Trichlorophenol	UG/KG	0	0%	100	0	0	69	44000 U	1000 U	220 U	3600 U	930 U	930 U
2,4,6-Trichlorophenol	UG/KG	0	0%		0	0	69	18000 U	430 U	89 U	1500 U	380 U	380 U
2,4-Dichlorophenol	UG/KG	0	0%	400	0	0	69	18000 U	430 U	89 U	1500 U	380 U	380 U
2,4-Dimethylphenol	UG/KG	0	0%		0	0	47	18000 U	430 U	89 U	1500 U	380 U	380 U
2,4-Dinitrophenol	UG/KG	0	0%	200	0	0	69	44000 U	1000 U	220 U	3600 U	930 U	930 U
2,4-Dinitrotoluene	UG/KG	880	1%		0	1	69	18000 U	430 U	89 U	1500 U	380 U	380 U
2,6-Dinitrotoluene	UG/KG	0	0%	1000	0	0	69	18000 U	430 U	89 U	1500 U	380 U	380 U
2-Chloronaphthalene	UG/KG	0	0%		0	0	47	18000 U	430 U	89 U	1500 U	380 U	380 U
2-Chlorophenol	UG/KG	0	0%	800	0	0	69	18000 U	430 U	89 U	1500 U	380 U	380 U
2-Methylnaphthalene	UG/KG	19000	22%	36400	0	15	69	18000 U	430 U	9.6 J	1500 U	380 U	380 U
2-Methylphenol	UG/KG	0	0%	100	0	0	69	18000 U	430 U	89 U	1500 U	380 U	380 U
2-Nitroaniline	UG/KG	0	0%	430	0	0	69	44000 U	1000 U	220 U	3600 U	930 U	930 U
2-Nitrophenol	UG/KG	0	0%	330	0	0	69	18000 U	430 U	89 U	1500 U	380 U	380 U
3,3'-Dichlorobenzidine	UG/KG	0	0%		0	0	69	18000 U	430 U	89 U	1500 U	380 U	380 U

Table A-4A
SURFACE SOIL SAMPLE RESULTS (0-2 ft.)
SEAD-71
SEAD-59 and SEAD-71 Phase II RI Report
Seneca Army Depot Activity

Facility	SEAD-71	SEAD-71	SEAD-71	SEAD-71	SEAD-71	SEAD-71
Location ID	SS71-6	SS71-8	SS71-9	TP71-2	TP71-2	TP71-2
Maxtrix	SOIL	SOIL	SOIL	SOIL	SOIL	SOIL
Sample ID	71028	71019	71018	TP71-2-1	TP71-2-2	TP71-2-4
Sample Depth to Top of Sample ⁽¹⁾	0	0	0	1	2	2
Sample Depth to Bottom of Sample ⁽¹⁾	0.2	0.2	0.2	1	2	2
Sample Date	11/21/1997	11/19/1997	11/19/1997	6/7/1994	6/7/1994	6/7/1994
QC Code	SA	SA	SA	SA	SA	SA
Study ID	RI PHASE 1 STEP 1	RI PHASE 1 STEP 1	RI PHASE 1 STEP 1	ESI	ESI	ESI
Sample Round						

Parameter	Units	Maximum Frequency of		NYSDEC TAGM 4046 ⁽²⁾	Number of Exceedances	Number of Detects	Number of Analyses	Value (Q)	Value (Q)	Value (Q)	Value (Q)	Value (Q)	Value (Q)
		Value	Detection										
3-Nitroaniline	UG/KG	0	0%	500	0	0	69	44000 U	1000 U	220 U	3600 U	930 U	930 U
4,6-Dinitro-2-methylphenol	UG/KG	0	0%		0	0	47	44000 U	1000 U	220 U	3600 U	930 U	930 U
4-Bromophenyl phenyl ether	UG/KG	0	0%		0	0	47	18000 U	430 U	89 U	1500 U	380 U	380 U
4-Chloro-3-methylphenol	UG/KG	0	0%	240	0	0	69	18000 U	430 U	89 U	1500 U	380 U	380 U
4-Chloroaniline	UG/KG	0	0%	220	0	0	69	18000 U	430 U	89 U	1500 U	380 U	380 U
4-Chlorophenyl phenyl ether	UG/KG	0	0%		0	0	47	18000 U	430 U	89 U	1500 U	380 U	380 U
4-Methylphenol	UG/KG	0	0%	900	0	0	69	18000 U	430 U	89 U	1500 U	380 U	380 U
4-Nitroaniline	UG/KG	75	2%		0	1	47	44000 U	1000 U	220 U	3600 U	930 U	930 U
4-Nitrophenol	UG/KG	0	0%	100	0	0	69	44000 U	1000 U	220 U	3600 U	930 U	930 U
Acenaphthene	UG/KG	42000	42%	50000	0	29	69	2600 J	96 J	38 J	1500 U	380 U	380 U
Acenaphthylene	UG/KG	1800	28%	41000	0	19	69	18000 U	73 J	22 J	1500 U	380 U	380 U
Acetophenone	UG/KG	0	0%		0	0	23						
Aniline	UG/KG	0	0%		0	0	22						
Anthracene	UG/KG	100000	59%	50000	3	41	69	10000 J	240 J	70 J	1500 U	380 U	380 U
Atrazine	UG/KG	0	0%		0	0	23						
Benzaldehyde	UG/KG	0	0%		0	0	23						
Benzo(a)anthracene	UG/KG	150000	77%	224	40	53	69	42000	880	310	370 J	250 J	120 J
Benzo(a)pyrene	UG/KG	120000	77%	61	47	53	69	47000	1100	360	490 J	290 J	94 J
Benzo(b)fluoranthene	UG/KG	88000	78%	1100	23	54	69	56000	1400	810	750 J	400	110 J
Benzo(ghi)perylene	UG/KG	62000	70%	50000	1	48	69	31000	940	220	370 J	150 J	36 J
Benzo(k)fluoranthene	UG/KG	130000	61%	1100	20	42	69	47000	1400	89 U	490 J	240 J	77 J
Benzoic Acid	UG/KG	0	0%	2700	0	0	22						
Bis(2-Chloroethoxy)methane	UG/KG	0	0%		0	0	47	18000 U	430 U	89 U	1500 U	380 U	380 U
Bis(2-Chloroethyl)ether	UG/KG	0	0%		0	0	47	18000 U	430 U	89 U	1500 U	380 U	380 U
Bis(2-Chloroisopropyl)ether	UG/KG	0	0%		0	0	20	18000 U	430 U	89 U			
Bis(2-Ethylhexyl)phthalate	UG/KG	140	9%	50000	0	6	69	18000 U	430 U	89 U	1500 U	380 U	380 U
Butylbenzylphthalate	UG/KG	0	0%	50000	0	0	69	18000 U	430 U	89 U	1500 U	380 U	380 U
Caprolactam	UG/KG	0	0%		0	0	23						
Carbazole	UG/KG	77000	57%		0	27	47	16000 J	510	160	1500 U	380 U	380 U
Chrysene	UG/KG	150000	81%	400	37	56	69	64000	1600	500	610 J	360 J	130 J
Di-n-butylphthalate	UG/KG	140	6%	8100	0	4	69	18000 U	430 U	6.4 J	1500 U	380 U	380 U
Di-n-octylphthalate	UG/KG	0	0%	50000	0	0	69	18000 U	430 U	89 U	1500 U	380 U	380 U
Dibenz(a,h)anthracene	UG/KG	25000	58%	14	40	40	69	12000 J	340 J	93	170 J	130 J	380 U
Dibenzofuran	UG/KG	38000	39%	6200	4	27	69	1300 J	75 J	21 J	1500 U	380 U	380 U
Diethyl phthalate	UG/KG	0	0%	7100	0	0	69	18000 U	430 U	89 U	1500 U	380 U	380 U
Dimethylphthalate	UG/KG	0	0%	2000	0	0	69	18000 U	430 U	89 U	1500 U	380 U	380 U
Fluoranthene	UG/KG	440000	84%	50000	6	58	69	110000	2400	710	690 J	580	240 J
Fluorene	UG/KG	62000	41%	50000	1	28	69	3200 J	100 J	31 J	1500 U	380 U	380 U

Table A-4A
SURFACE SOIL SAMPLE RESULTS (0-2 ft.)
SEAD-71
SEAD-59 and SEAD-71 Phase II RI Report
Seneca Army Depot Activity

Facility	SEAD-71	SEAD-71	SEAD-71	SEAD-71	SEAD-71	SEAD-71
Location ID	SS71-6	SS71-8	SS71-9	TP71-2	TP71-2	TP71-2
Maxtrix	SOIL	SOIL	SOIL	SOIL	SOIL	SOIL
Sample ID	71028	71019	71018	TP71-2-1	TP71-2-2	TP71-2-4
Sample Depth to Top of Sample ⁽¹⁾	0	0	0	1	2	2
Sample Depth to Bottom of Sample ⁽¹⁾	0.2	0.2	0.2	1	2	2
Sample Date	11/21/1997	11/19/1997	11/19/1997	6/7/1994	6/7/1994	6/7/1994
QC Code	SA	SA	SA	SA	SA	SA
Study ID	RI PHASE 1 STEP 1	RI PHASE 1 STEP 1	RI PHASE 1 STEP 1	ESI	ESI	ESI
Sample Round						

Parameter	Units	Maximum Frequency of		NYSDEC TAGM 4046 ⁽²⁾	Number of Exceedances	Number of Detects	Number of Analyses	Value (Q)	Value (Q)	Value (Q)	Value (Q)	Value (Q)	Value (Q)
		Value	Detection										
Hexachlorobenzene	UG/KG	0	0%	410	0	0	69	18000 U	430 U	89 U	1500 U	380 U	380 U
Hexachlorobutadiene	UG/KG	0	0%		0	0	69	18000 U	430 U	89 U	1500 U	380 U	380 U
Hexachlorocyclopentadiene	UG/KG	0	0%		0	0	47	18000 U	430 U	89 U	1500 U	380 U	380 U
Hexachloroethane	UG/KG	0	0%		0	0	69	18000 U	430 U	89 U	1500 U	380 U	380 U
Indeno(1,2,3-cd)pyrene	UG/KG	65000	70%	3200	11	48	69	28000	780	200	430 J	220 J	52 J
Isophorone	UG/KG	0	0%	4400	0	0	69	18000 U	430 U	89 U	1500 U	380 U	380 U
N-Nitrosodiphenylamine	UG/KG	0	0%		0	0	47	18000 U	430 U	89 U	1500 U	380 U	380 U
N-Nitrosodipropylamine	UG/KG	0	0%		0	0	47	18000 U	430 U	89 U	1500 U	380 U	380 U
Naphthalene	UG/KG	46000	22%	13000	1	15	69	18000 U	430 U	15 J	1500 U	380 U	380 U
Nitrobenzene	UG/KG	0	0%	200	0	0	69	18000 U	430 U	89 U	1500 U	380 U	380 U
Pentachlorophenol	UG/KG	0	0%	1000	0	0	69	44000 U	1000 U	220 U	3600 U	930 U	930 U
Phenanthrene	UG/KG	290000	78%	50000	5	54	69	49000	880	390	270 J	180 J	80 J
Phenol	UG/KG	4.5	1%	30	0	1	69	18000 U	430 U	89 U	1500 U	380 U	380 U
Pyrene	UG/KG	280000	81%	50000	6	56	69	98000	1900	590	1000 J	660	260 J
Pyridine	UG/KG	0	0%		0	0	22						
Pesticides/PCBs													
4,4'-DDD	UG/KG	240	26%	2900	0	18	69	50	4.3 U	4.4 U	3.4 J	3.8 U	3.8 U
4,4'-DDE	UG/KG	810	42%	2100	0	29	69	99	19	15	3.7 U	3.8 U	3.8 U
4,4'-DDT	UG/KG	1300	51%	2100	0	35	69	250	77	25	2.7 J	3.8 U	3.8 U
Aldrin	UG/KG	0	0%	41	0	0	69	19 U	2.2 U	2.3 U	1.9 U	2 U	2 U
Alpha-BHC	UG/KG	18	7%	110	0	5	69	19 U	2.2 U	2.3 U	1.9 U	2 U	2 U
Alpha-Chlordane	UG/KG	2	1%		0	1	69	19 U	2.2 U	2.3 U	2 J	2 U	2 U
Beta-BHC	UG/KG	35	9%	200	0	6	69	19 U	2.2 U	2.3 U	1.9 U	2 U	2 U
Delta-BHC	UG/KG	0	0%	300	0	0	69	19 U	2.2 U	2.3 U	1.9 U	2 U	2 U
Dieldrin	UG/KG	3.4	3%	44	0	2	69	37 U	4.3 U	4.4 U	3.7 U	3.8 U	3.8 U
Endosulfan I	UG/KG	15	10%	900	0	7	69	19 U	2.2 U	2.3 U	5.1 J	6.9 J	3.4 J
Endosulfan II	UG/KG	52	4%	900	0	3	69	50	4.3 U	4.4 U	2 J	3.8 U	3.8 U
Endosulfan sulfate	UG/KG	110	16%	1000	0	11	69	36 J	4.6	4.4 U	2.2 J	3.8 U	3.8 U
Endrin	UG/KG	120	14%	100	1	10	69	54	4.3 U	4.4 U	3.7 U	3.8 U	3.8 U
Endrin aldehyde	UG/KG	120	23%		0	16	69	120	6.1	4.4 U	3.7 U	3.8 U	3.8 U
Endrin ketone	UG/KG	180	22%		0	15	69	120	11	4.4 U	3.7 U	3.8 U	3.8 U
Gamma-BHC/Lindane	UG/KG	0	0%	60	0	0	69	19 U	2.2 U	2.3 U	1.9 U	2 U	2 U
Gamma-Chlordane	UG/KG	48	6%	540	0	4	69	19 U	2.2 U	2.3 U	1.9 U	2 U	2 U
Heptachlor	UG/KG	0	0%	100	0	0	69	19 U	2.2 U	2.3 U	1.9 U	2 U	2 U
Heptachlor epoxide	UG/KG	180	17%	20	4	12	69	70	2.2 U	2.3 U	1.9 U	2 U	2 U
Methoxychlor	UG/KG	520	16%		0	11	69	170 J	62	23 U	19 U	20 U	20 U
Toxaphene	UG/KG	0	0%		0	0	69	1900 U	220 U	230 U	190 U	200 U	200 U
Aroclor-1016	UG/KG	0	0%		0	0	69	370 U	43 U	44 U	37 U	38 U	38 U

Table A-4A
SURFACE SOIL SAMPLE RESULTS (0-2 ft.)
SEAD-71
SEAD-59 and SEAD-71 Phase II RI Report
Seneca Army Depot Activity

Facility	SEAD-71	SEAD-71	SEAD-71	SEAD-71	SEAD-71	SEAD-71
Location ID	SS71-6	SS71-8	SS71-9	TP71-2	TP71-2	TP71-2
Maxtrix	SOIL	SOIL	SOIL	SOIL	SOIL	SOIL
Sample ID	71028	71019	71018	TP71-2-1	TP71-2-2	TP71-2-4
Sample Depth to Top of Sample ⁽¹⁾	0	0	0	1	2	2
Sample Depth to Bottom of Sample ⁽¹⁾	0.2	0.2	0.2	1	2	2
Sample Date	11/21/1997	11/19/1997	11/19/1997	6/7/1994	6/7/1994	6/7/1994
QC Code	SA	SA	SA	SA	SA	SA
Study ID	RI PHASE 1 STEP 1	RI PHASE 1 STEP 1	RI PHASE 1 STEP 1	ESI	ESI	ESI
Sample Round						

Parameter	Units	Maximum Frequency of		NYSDEC TAGM 4046 ⁽²⁾	Number of Exceedances	Number of Detects	Number of Analyses	Value (Q)	Value (Q)	Value (Q)	Value (Q)	Value (Q)	Value (Q)
		Value	Detection										
Aroclor-1221	UG/KG	0	0%		0	0	69	740 U	87 U	90 U	76 U	78 U	78 U
Aroclor-1232	UG/KG	0	0%		0	0	69	370 U	43 U	44 U	37 U	38 U	38 U
Aroclor-1242	UG/KG	0	0%		0	0	69	370 U	43 U	44 U	37 U	38 U	38 U
Aroclor-1248	UG/KG	0	0%		0	0	69	370 U	43 U	44 U	37 U	38 U	38 U
Aroclor-1254	UG/KG	0	0%	10000	0	0	69	370 U	43 U	44 U	37 U	38 U	38 U
Aroclor-1260	UG/KG	200	4%	10000	0	3	69	370 U	43 U	44 U	37 U	38 U	38 U
Metals													
Aluminum	MG/KG	18000	100%	19300	0	69	69	2860	13600	15900	9630	12500	15200
Antimony	MG/KG	19.3	49%	5.9	5	34	69	0.76 UJ	0.84 UJ	0.93 UJ	0.21 J	0.18 UJ	0.25 UJ
Arsenic	MG/KG	14.6	100%	8.2	5	69	69	4.8	5.9	14.6	4.2	4.8	7.8
Barium	MG/KG	179	100%	300	0	69	69	39.9 J	101 J	86.2 J	37.5	57.6	76.1
Beryllium	MG/KG	0.88	99%	1.1	0	68	69	0.11	0.38	0.43	0.44 J	0.48 J	0.7 J
Cadmium	MG/KG	12.1	67%	2.3	4	46	69	1.1 UJ	0.07 UJ	0.08 UJ	0.44 J	0.43 J	0.48 J
Calcium	MG/KG	295000	100%	121000	11	69	69	261000	27300	9080	10500 J	37200 J	27300 J
Chromium	MG/KG	60.3	100%	29.6	5	69	69	14.6 J	22.2 J	23.8 J	18.1	16.7	22
Cobalt	MG/KG	14.6	100%	30	0	69	69	6.4	11.5	12.5	11.4	9	13.4
Copper	MG/KG	134	100%	33	21	69	69	18.4 J	23.6 J	45.3 J	37.5	17.5	23.5
Cyanide	MG/KG	0	0%	0.35	0	0	24	0.58 U	0.71 U	0.67 U	0.54 U	0.44 U	0.56 U
Iron	MG/KG	65100	100%	36500	2	69	69	11000	27200	38000	22400	22100	32100
Lead	MG/KG	3470	100%	24.8	33	69	69	99.9 J	74.3 J	33 J	25.3	11.2	15.1
Magnesium	MG/KG	59300	100%	21500	6	69	69	18500	6820	5570	4830	13100	6320
Manganese	MG/KG	1330	100%	1060	1	69	69	427 J	743 J	735 J	255	434	503
Mercury	MG/KG	2.7	80%	0.1	10	55	69	0.05 UJ	0.06 UJ	0.07 UJ	0.04 J	0.15	0.02 J
Nickel	MG/KG	110	100%	49	2	69	69	16.4	26.9	30.9	42.5	23.2	36.1
Potassium	MG/KG	2180	100%	2380	0	69	69	1240	1750	2180	992 J	1010 J	1300 J
Selenium	MG/KG	1.8	19%	2	0	13	69	1 UJ	1.1 UJ	1.4 J	0.91	0.37 U	0.74 J
Silver	MG/KG	2.2	39%	0.75	15	27	69	0.46 UJ	0.51 UJ	0.67 UJ	0.06 UJ	0.07 UJ	0.1 UJ
Sodium	MG/KG	1040	97%	172	19	67	69	297	215	237	50 J	45.6 J	37.2 J
Thallium	MG/KG	2.3	26%	0.7	10	18	69	1.4 U	1.5 U	2.3	0.24 U	0.26 U	0.36 U
Vanadium	MG/KG	29.2	100%	150	0	69	69	11	19.8	23.4	15.4	19.2	23.1
Zinc	MG/KG	3660	99%	110	17	68	69	94.4 J	118 J	95.5 J	128	58.9	79.3

Note(s):
(1) - Historical sample depths are presented (I.e. prior to 2002 TCRA)
(2) - NYSDEC Technical and Administrative Guidance Memorandum (TAGM) HWR-94-4046

U = compound was not detected
J = the reported value is an estimated concentration

Table A-4A
SURFACE SOIL SAMPLE RESULTS (0-2 ft.)
SEAD-71
SEAD-59 and SEAD-71 Phase II RI Report
Seneca Army Depot Activity

Facility	SEAD-71	SEAD-71	SEAD-71	SEAD-71	SEAD-71	SEAD-71
Location ID	SS71-6	SS71-8	SS71-9	TP71-2	TP71-2	TP71-2
Maxtrix	SOIL	SOIL	SOIL	SOIL	SOIL	SOIL
Sample ID	71028	71019	71018	TP71-2-1	TP71-2-2	TP71-2-4
Sample Depth to Top of Sample ⁽¹⁾	0	0	0	1	2	2
Sample Depth to Bottom of Sample ⁽¹⁾	0.2	0.2	0.2	1	2	2
Sample Date	11/21/1997	11/19/1997	11/19/1997	6/7/1994	6/7/1994	6/7/1994
QC Code	SA	SA	SA	SA	SA	SA
Study ID	RI PHASE 1 STEP 1	RI PHASE 1 STEP 1	RI PHASE 1 STEP 1	ESI	ESI	ESI
Sample Round						

Parameter	Units	Maximum Value	Frequency of Detection	NYSDEC TAGM 4046 ⁽²⁾	Number of Exceedances	Number of Detects	Number of Analyses	Value (Q)	Value (Q)	Value (Q)	Value (Q)	Value (Q)	Value (Q)
-----------	-------	---------------	------------------------	---------------------------------	-----------------------	-------------------	--------------------	-----------	-----------	-----------	-----------	-----------	-----------

UJ = the compound was not detected; the associated reporting limit is approximate

R = the data was rejected in the data validating process

NJ = compound was "tentatively identified" and the associated numerical value is approximate

Table A-4A
SURFACE SOIL SAMPLE RESULTS (0-2 ft.)
SEAD-71
SEAD-59 and SEAD-71 Phase II RI Report
Seneca Army Depot Activity

Facility	SEAD-71	SEAD-71	SEAD-71	SEAD-71	SEAD-71	SEAD-71
Location ID	TP71-2	TP71-3-1	WS-71-A-009-9	WS-71-B-009-6	WS-71-B-009-8	WS-71-D-009-13
Maxtrix	SOIL	SOIL	SOIL	SOIL	SOIL	SOIL
Sample ID	TP71-2-3	71002	WS-71-A-009-9	WS-71-B-009-6	WS-71-B-009-8	WS-71-D-009-13
Sample Depth to Top of Sample ⁽¹⁾	2	0	0	0	0	0
Sample Depth to Bottom of Sample ⁽¹⁾	3.3	8	0	0	0	0
Sample Date	6/7/1994	10/14/1997	5/6/2004	5/6/2004	5/6/2004	5/6/2004
QC Code	SA	SA	SA	SA	SA	SA
Study ID	ESI	RI PHASE 1 STEP 1	ENSR IRM	ENSR IRM	ENSR IRM	ENSR IRM
Sample Round			1	1	1	1

Parameter	Units	Maximum Value	Frequency of Detection	NYSDEC TAGM 4046 ⁽²⁾	Number of Exceedances	Number of Detects	Number of Analyses	SEAD-71		SEAD-59		SEAD-71	
								Value (Q)	Value (Q)	Value (Q)	Value (Q)	Value (Q)	Value (Q)
Volatile Organics													
1,1,1-Trichloroethane	UG/KG	3	3%	800	0	2	68	3 J	11 U	6 U	5 U	5 U	5.8 U
1,1,2,2-Tetrachloroethane	UG/KG	0	0%	600	0	0	64	12 U	11 U	6 UJ	5 UJ	5 R	5.8 U
1,1,2-Trichloro-1,2,2-Trifluoroethane	UG/KG	0	0%		0	0	44			6 U	5 U	5 U	5.8 U
1,1,2-Trichloroethane	UG/KG	0	0%		0	0	47	12 U	11 U	6 U	5 U	5 U	
1,1-Dichloroethane	UG/KG	0	0%	200	0	0	68	12 U	11 U	6 U	5 U	5 U	5.8 U
1,1-Dichloroethene	UG/KG	0	0%	400	0	0	68	12 U	11 U	6 U	5 U	5 U	5.8 U
1,2,3-Trichloropropane	UG/KG	0	0%		0	0	21						5.8 U
1,2,4-Trichlorobenzene	UG/KG	0	0%	3400	0	0	40			6 UJ	5 UJ	5 R	5.8 U
1,2-Dibromo-3-chloropropane	UG/KG	0	0%		0	0	19			6 UJ	5 UJ	5 R	
1,2-Dibromoethane	UG/KG	0	0%		0	0	23			6 UJ	5 UJ	5 UJ	
1,2-Dichlorobenzene	UG/KG	0	0%	7900	0	0	40			6 UJ	5 UJ	5 R	5.8 U
1,2-Dichloroethane	UG/KG	0	0%	100	0	0	68	12 U	11 U	6 U	5 U	5 U	5.8 U
1,2-Dichloroethene (total)	UG/KG	0	0%		0	0	24	12 U	11 U				
1,2-Dichloropropane	UG/KG	0	0%		0	0	47	12 U	11 U	6 U	5 U	5 U	
1,3-Dichlorobenzene	UG/KG	0	0%	1600	0	0	40			6 UJ	5 UJ	5 R	5.8 U
1,3-Dichloropropane	UG/KG	0	0%		0	0	21						5.8 U
1,4-Dichlorobenzene	UG/KG	0	0%	8500	0	0	40			6 UJ	5 UJ	5 R	5.8 U
Acetone	UG/KG	74	13%	200	0	9	68	12 U	11 U	6 U	5 U	5 U	23 U
Benzene	UG/KG	2	3%	60	0	2	68	12 U	11 U	1 J	5 U	5 U	5.8 U
Bromodichloromethane	UG/KG	0	0%		0	0	47	12 U	11 U	6 U	5 U	5 U	
Bromoform	UG/KG	0	0%		0	0	47	12 U	11 U	6 UJ	5 UJ	5 UJ	
Carbon disulfide	UG/KG	5	4%	2700	0	3	68	12 U	11 U	2 J	5 U	2 J	5.8 U
Carbon tetrachloride	UG/KG	0	0%	600	0	0	68	12 U	11 U	6 U	5 UJ	5 U	5.8 U
Chlorobenzene	UG/KG	0	0%	1700	0	0	68	12 U	11 U	6 UJ	5 UJ	5 UJ	5.8 U
Chlorodibromomethane	UG/KG	0	0%		0	0	68	12 U	11 U	6 UJ	5 UJ	5 UJ	5.8 U
Chloroethane	UG/KG	0	0%	1900	0	0	68	12 U	11 U	6 U	5 U	5 U	12 U
Chloroform	UG/KG	0	0%	300	0	0	68	12 U	11 U	6 U	5 U	5 U	5.8 U
Cis-1,2-Dichloroethene	UG/KG	0	0%		0	0	23			6 U	5 U	5 U	
Cis-1,3-Dichloropropene	UG/KG	0	0%		0	0	47	12 U	11 U	6 U	5 U	5 U	
Cyclohexane	UG/KG	4	9%		0	2	23			4 J	5 U	3 J	
Dichlorodifluoromethane	UG/KG	0	0%		0	0	23			6 U	5 U	5 U	
Ethyl benzene	UG/KG	4	3%	5500	0	2	68	12 U	11 U	6 UJ	5 UJ	5 UJ	5.8 U
Isopropylbenzene	UG/KG	0	0%		0	0	23			6 UJ	5 UJ	5 UJ	
Meta/Para Xylene	UG/KG	0	0%		0	0	21						5.8 U
Methyl Acetate	UG/KG	0	0%		0	0	23			6 U	5 U	5 U	
Methyl Tertbutyl Ether	UG/KG	0	0%		0	0	23			6 U	5 U	5 U	
Methyl bromide	UG/KG	0	0%		0	0	47	12 U	11 U	6 U	5 U	5 U	

Table A-4A
SURFACE SOIL SAMPLE RESULTS (0-2 ft.)
SEAD-71
SEAD-59 and SEAD-71 Phase II RI Report
Seneca Army Depot Activity

Facility	SEAD-71	SEAD-71	SEAD-71	SEAD-71	SEAD-71	SEAD-71
Location ID	TP71-2	TP71-3-1	WS-71-A-009-9	WS-71-B-009-6	WS-71-B-009-8	WS-71-D-009-13
Maxtrix	SOIL	SOIL	SOIL	SOIL	SOIL	SOIL
Sample ID	TP71-2-3	71002	WS-71-A-009-9	WS-71-B-009-6	WS-71-B-009-8	WS-71-D-009-13
Sample Depth to Top of Sample ⁽¹⁾	2	0	0	0	0	0
Sample Depth to Bottom of Sample ⁽¹⁾	3.3	8	0	0	0	0
Sample Date	6/7/1994	10/14/1997	5/6/2004	5/6/2004	5/6/2004	5/6/2004
QC Code	SA	SA	SA	SA	SA	SA
Study ID	ESI	RI PHASE 1 STEP 1	ENSR IRM	ENSR IRM	ENSR IRM	ENSR IRM
Sample Round			1	1	1	1

Parameter	Units	Maximum Value	Frequency of Detection	NYSDEC TAGM 4046 ⁽²⁾	Number of Exceedances	Number of Detects	Number of Analyses	Value (Q)						
								Value (Q)	Value (Q)	Value (Q)	Value (Q)	Value (Q)	Value (Q)	Value (Q)
Methyl butyl ketone	UG/KG	0	0%		0	0	47	12 U	11 U	6 UJ	5 UJ	5 UJ		
Methyl chloride	UG/KG	0	0%		0	0	47	12 U	11 U	6 U	5 U	5 U		
Methyl cyclohexane	UG/KG	6	13%		0	3	23			6	5 U	4 J		
Methyl ethyl ketone	UG/KG	0	0%	300	0	0	68	12 U	11 U	6 U	5 UJ	5 U		12 U
Methyl isobutyl ketone	UG/KG	0	0%	1000	0	0	68	12 U	11 U	6 U	5 UJ	5 U		12 U
Methylene chloride	UG/KG	11	12%	100	0	8	68	3 J	11 U	6 U	2 J	5 U		1.6 J
Ortho Xylene	UG/KG	0	0%		0	0	21							5.8 U
Styrene	UG/KG	1	2%		0	1	47	12 U	11 U	6 UJ	5 UJ	5 UJ		
Tetrachloroethene	UG/KG	33	1%	1400	0	1	68	12 U	11 U	6 UJ	5 UJ	5 UJ		5.8 U
Toluene	UG/KG	16	16%	1500	0	11	68	12 U	11 U	2 J	5 U	2 J		5.8 U
Total BTEX	MG/KG	11.6	100%		0	1	1		11.6					
Total Xylenes	UG/KG	11	11%	1200	0	5	44	12 U	3 J	2 J	5 UJ	3 J		
Trans-1,2-Dichloroethene	UG/KG	0	0%	300	0	0	44			6 U	5 U	5 U		5.8 U
Trans-1,3-Dichloropropene	UG/KG	0	0%		0	0	47	12 U	11 U	6 U	5 U	5 U		
Trichloroethene	UG/KG	0	0%	700	0	0	68	12 U	11 U	6 U	5 U	5 U		5.8 U
Trichlorofluoromethane	UG/KG	1	4%		0	1	23			6 U	1 J	5 U		
Vinyl chloride	UG/KG	0	0%	200	0	0	68	12 U	11 U	6 U	5 U	5 U		12 U
Semivolatle Organics														
1,1'-Biphenyl	UG/KG	0	0%		0	0	23			370 U	360 U	370 U		
1,2,4-Trichlorobenzene	UG/KG	0	0%	3400	0	0	24	420 U		66 U				
1,2-Dichlorobenzene	UG/KG	0	0%	7900	0	0	24	420 U		66 U				
1,3-Dichlorobenzene	UG/KG	0	0%	1600	0	0	24	420 U		66 U				
1,4-Dichlorobenzene	UG/KG	0	0%	8500	0	0	24	420 U		66 U				
2,2'-oxybis(1-Chloropropane)	UG/KG	0	0%		0	0	27	420 U			370 U	360 U	370 U	
2,4,5-Trichlorophenol	UG/KG	0	0%	100	0	0	69	1000 U	160 U	940 U	910 U	920 U		1100 U
2,4,6-Trichlorophenol	UG/KG	0	0%		0	0	69	420 U		66 U	370 U	360 U	370 U	1100 U
2,4-Dichlorophenol	UG/KG	0	0%	400	0	0	69	420 U		66 U	370 U	360 U	370 U	1100 U
2,4-Dimethylphenol	UG/KG	0	0%		0	0	47	420 U		66 U	370 U	360 U	370 U	
2,4-Dinitrophenol	UG/KG	0	0%	200	0	0	69	1000 U	160 U	940 U	910 U	920 U		5900 UJ
2,4-Dinitrotoluene	UG/KG	880	1%		0	1	69	420 U		66 U	370 U	360 U	370 U	880 J
2,6-Dinitrotoluene	UG/KG	0	0%	1000	0	0	69	420 U		66 U	370 U	360 U	370 U	1100 U
2-Chloronaphthalene	UG/KG	0	0%		0	0	47	420 U		66 U	370 U	360 U	370 U	
2-Chlorophenol	UG/KG	0	0%	800	0	0	69	420 U		66 U	370 U	360 U	370 U	1100 U
2-Methylnaphthalene	UG/KG	19000	22%	36400	0	15	69	420 U	520	370 U	360 U	370 U	370 U	1100 U
2-Methylphenol	UG/KG	0	0%	100	0	0	69	420 U		66 U	370 U	360 U	370 U	1100 U
2-Nitroaniline	UG/KG	0	0%	430	0	0	69	1000 U	160 U	940 U	910 U	920 U		5900 U
2-Nitrophenol	UG/KG	0	0%	330	0	0	69	420 U		66 U	370 U	360 U	370 U	1100 U
3,3'-Dichlorobenzidine	UG/KG	0	0%		0	0	69	420 U		66 U	370 U	360 U	370 U	1100 U

Table A-4A
SURFACE SOIL SAMPLE RESULTS (0-2 ft.)
SEAD-71
SEAD-59 and SEAD-71 Phase II RI Report
Seneca Army Depot Activity

Facility	SEAD-71	SEAD-71	SEAD-71	SEAD-71	SEAD-71	SEAD-71
Location ID	TP71-2	TP71-3-1	WS-71-A-009-9	WS-71-B-009-6	WS-71-B-009-8	WS-71-D-009-13
Maxtrix	SOIL	SOIL	SOIL	SOIL	SOIL	SOIL
Sample ID	TP71-2-3	71002	WS-71-A-009-9	WS-71-B-009-6	WS-71-B-009-8	WS-71-D-009-13
Sample Depth to Top of Sample ⁽¹⁾	2	0	0	0	0	0
Sample Depth to Bottom of Sample ⁽¹⁾	3.3	8	0	0	0	0
Sample Date	6/7/1994	10/14/1997	5/6/2004	5/6/2004	5/6/2004	5/6/2004
QC Code	SA	SA	SA	SA	SA	SA
Study ID	ESI	RI PHASE 1 STEP 1	ENSR IRM	ENSR IRM	ENSR IRM	ENSR IRM
Sample Round			1	1	1	1

Parameter	Units	Maximum Frequency of		NYSDEC TAGM 4046 ⁽²⁾	Number of Exceedances	Number of Detects	Number of Analyses	Value (Q)	Value (Q)	Value (Q)	Value (Q)	Value (Q)	Value (Q)
		Value	Detection										
3-Nitroaniline	UG/KG	0	0%	500	0	0	69	1000 U	160 U	940 U	910 U	920 U	5900 U
4,6-Dinitro-2-methylphenol	UG/KG	0	0%		0	0	47	1000 U	160 U	940 U	910 U	920 U	
4-Bromophenyl phenyl ether	UG/KG	0	0%		0	0	47	420 U	66 U	370 U	360 U	370 U	
4-Chloro-3-methylphenol	UG/KG	0	0%	240	0	0	69	420 U	66 U	370 U	360 U	370 U	1100 U
4-Chloroaniline	UG/KG	0	0%	220	0	0	69	420 U	66 U	370 U	360 U	370 U	1100 U
4-Chlorophenyl phenyl ether	UG/KG	0	0%		0	0	47	420 U	66 U	370 U	360 U	370 U	
4-Methylphenol	UG/KG	0	0%	900	0	0	69	420 U	66 U	370 U	360 U	370 U	1100 U
4-Nitroaniline	UG/KG	75	2%		0	1	47	1000 U	160 U	940 U	75 J	920 U	
4-Nitrophenol	UG/KG	0	0%	100	0	0	69	1000 U	160 U	940 U	910 U	920 U	5900 U
Acenaphthene	UG/KG	42000	42%	50000	0	29	69	420 U	830 J	370 U	360 U	62 J	1100 U
Acenaphthylene	UG/KG	1800	28%	41000	0	19	69	420 U	66 U	370 U	97 J	130 J	1100 U
Acetophenone	UG/KG	0	0%		0	0	23			370 U	360 U	370 U	
Aniline	UG/KG	0	0%		0	0	22						1100 U
Anthracene	UG/KG	100000	59%	50000	3	41	69	420 U	48 J	45 J	170 J	520	360 J
Atrazine	UG/KG	0	0%		0	0	23			370 U	360 U	370 U	
Benzaldehyde	UG/KG	0	0%		0	0	23			370 U	360 U	370 U	
Benzo(a)anthracene	UG/KG	150000	77%	224	40	53	69	420 U	32 J	180 J	730	1500	830 J
Benzo(a)pyrene	UG/KG	120000	77%	61	47	53	69	420 U	66 U	170 J	810	1400	610 J
Benzo(b)fluoranthene	UG/KG	88000	78%	1100	23	54	69	420 U	66 U	230 J	1100	1900	650 J
Benzo(ghi)perylene	UG/KG	62000	70%	50000	1	48	69	420 U	66 U	99 J	490	770	430 J
Benzo(k)fluoranthene	UG/KG	130000	61%	1100	20	42	69	420 U	66 U	94 J	440	670	650 J
Benzoic Acid	UG/KG	0	0%	2700	0	0	22						5900 U
Bis(2-Chloroethoxy)methane	UG/KG	0	0%		0	0	47	420 U	66 U	370 U	360 U	370 U	
Bis(2-Chloroethyl)ether	UG/KG	0	0%		0	0	47	420 U	66 U	370 U	360 U	370 U	
Bis(2-Chloroisopropyl)ether	UG/KG	0	0%		0	0	20		66 U				
Bis(2-Ethylhexyl)phthalate	UG/KG	140	9%	50000	0	6	69	420 U	66 U	43 J	47 J	56 J	140 J
Butylbenzylphthalate	UG/KG	0	0%	50000	0	0	69	420 U	66 U	370 U	360 U	370 U	1100 U
Caprolactam	UG/KG	0	0%		0	0	23			370 U	360 U	370 U	
Carbazole	UG/KG	77000	57%		0	27	47	420 U	40 J	370 U	59 J	240 J	
Chrysene	UG/KG	150000	81%	400	37	56	69	420 U	49 J	190 J	820	1500	1000 J
Di-n-butylphthalate	UG/KG	140	6%	8100	0	4	69	420 U	66 U	370 U	360 U	370 U	1100 U
Di-n-octylphthalate	UG/KG	0	0%	50000	0	0	69	420 U	66 U	370 U	360 U	370 U	1100 U
Dibenz(a,h)anthracene	UG/KG	25000	58%	14	40	40	69	420 U	66 U	370 U	42 J	230 J	170 J
Dibenzofuran	UG/KG	38000	39%	6200	4	27	69	420 U	670 J	370 U	360 U	38 J	1100 U
Diethyl phthalate	UG/KG	0	0%	7100	0	0	69	420 U	66 U	370 U	360 U	370 U	1100 U
Dimethylphthalate	UG/KG	0	0%	2000	0	0	69	420 U	66 U	370 U	360 U	370 U	1100 U
Fluoranthene	UG/KG	440000	84%	50000	6	58	69	63 J	220	350 J	1300	2700	1800
Fluorene	UG/KG	62000	41%	50000	1	28	69	420 U	270	370 U	360 U	99 J	1100 U

Table A-4A
SURFACE SOIL SAMPLE RESULTS (0-2 ft.)
SEAD-71
SEAD-59 and SEAD-71 Phase II RI Report
Seneca Army Depot Activity

Facility	SEAD-71	SEAD-71	SEAD-71	SEAD-71	SEAD-71	SEAD-71
Location ID	TP71-2	TP71-3-1	WS-71-A-009-9	WS-71-B-009-6	WS-71-B-009-8	WS-71-D-009-13
Maxtrix	SOIL	SOIL	SOIL	SOIL	SOIL	SOIL
Sample ID	TP71-2-3	71002	WS-71-A-009-9	WS-71-B-009-6	WS-71-B-009-8	WS-71-D-009-13
Sample Depth to Top of Sample ⁽¹⁾	2	0	0	0	0	0
Sample Depth to Bottom of Sample ⁽¹⁾	3.3	8	0	0	0	0
Sample Date	6/7/1994	10/14/1997	5/6/2004	5/6/2004	5/6/2004	5/6/2004
QC Code	SA	SA	SA	SA	SA	SA
Study ID	ESI	RI PHASE 1 STEP 1	ENSR IRM	ENSR IRM	ENSR IRM	ENSR IRM
Sample Round			1	1	1	1

Parameter	Units	Maximum Frequency of		NYSDEC TAGM 4046 ⁽²⁾	Number of Exceedances	Number of Detects	Number of Analyses	Value (Q)	Value (Q)	Value (Q)	Value (Q)	Value (Q)	Value (Q)
		Value	Detection										
Hexachlorobenzene	UG/KG	0	0%	410	0	0	69	420 U	66 U	370 U	360 U	370 U	1100 U
Hexachlorobutadiene	UG/KG	0	0%		0	0	69	420 U	66 U	370 U	360 U	370 U	1100 U
Hexachlorocyclopentadiene	UG/KG	0	0%		0	0	47	420 U	66 U	370 U	360 U	370 U	
Hexachloroethane	UG/KG	0	0%		0	0	69	420 U	66 U	370 U	360 U	370 U	1100 U
Indeno(1,2,3-cd)pyrene	UG/KG	65000	70%	3200	11	48	69	420 U	66 U	110 J	530	860	420 J
Isophorone	UG/KG	0	0%	4400	0	0	69	420 U	66 U	370 U	360 U	370 U	1100 U
N-Nitrosodiphenylamine	UG/KG	0	0%		0	0	47	420 U	66 U	370 U	360 U	370 U	
N-Nitrosodipropylamine	UG/KG	0	0%		0	0	47	420 U	66 U	370 U	360 U	370 U	
Naphthalene	UG/KG	46000	22%	13000	1	15	69	420 U	590 J	370 U	360 U	370 U	1100 U
Nitrobenzene	UG/KG	0	0%	200	0	0	69	420 U	66 U	370 U	360 U	370 U	1100 U
Pentachlorophenol	UG/KG	0	0%	1000	0	0	69	1000 U	160 U	940 U	910 U	920 U	5900 U
Phenanthrene	UG/KG	290000	78%	50000	5	54	69	30 J	350	150 J	400	1600	500 J
Phenol	UG/KG	4.5	1%	30	0	1	69	420 U	4.5 J	370 U	360 U	370 U	1100 U
Pyrene	UG/KG	280000	81%	50000	6	56	69	73 J	370	300 J	1300	2700	1300
Pyridine	UG/KG	0	0%		0	0	22						5900 U
Pesticides/PCBs													
4,4'-DDD	UG/KG	240	26%	2900	0	18	69	4.2 U	3.9 U	3.7 U	8 J	18 U	38 U
4,4'-DDE	UG/KG	810	42%	2100	0	29	69	4.2 U	3.9 U	14	36 J	100 J	38 U
4,4'-DDT	UG/KG	1300	51%	2100	0	35	69	4.2 U	3.9 U	7.1	40	55	38 U
Aldrin	UG/KG	0	0%	41	0	0	69	2.2 U	2 U	1.9 U	1.9 U	9.4 U	20 U
Alpha-BHC	UG/KG	18	7%	110	0	5	69	2.2 U	2 U	1.9 U	1.9 U	9.4 U	20 U
Alpha-Chlordane	UG/KG	2	1%		0	1	69	2.2 U	2 U	1.9 U	1.9 U	9.4 U	20 U
Beta-BHC	UG/KG	35	9%	200	0	6	69	2.2 U	2 U	1.9 U	1.9 U	9.4 U	20 U
Delta-BHC	UG/KG	0	0%	300	0	0	69	2.2 U	2 U	1.9 U	1.9 U	9.4 U	20 U
Dieldrin	UG/KG	3.4	3%	44	0	2	69	4.2 U	3.9 U	3.7 U	3.7 U	18 U	38 U
Endosulfan I	UG/KG	15	10%	900	0	7	69	2.2 U	2 U	1.9 U	1.9 U	9.4 U	20 U
Endosulfan II	UG/KG	52	4%	900	0	3	69	4.2 U	3.9 U	3.7 U	3.7 U	18 U	38 U
Endosulfan sulfate	UG/KG	110	16%	1000	0	11	69	4.2 U	3.9 U	3.7 U	3.7 U	18 U	38 U
Endrin	UG/KG	120	14%	100	1	10	69	4.2 U	3.9 U	3.7 U	3.7 U	18 U	38 U
Endrin aldehyde	UG/KG	120	23%		0	16	69	4.2 U	3.9 U	3.7 U	3.7 U	18 U	38 U
Endrin ketone	UG/KG	180	22%		0	15	69	4.2 U	3.9 U	3.7 U	3.7 U	18 U	38 U
Gamma-BHC/Lindane	UG/KG	0	0%	60	0	0	69	2.2 U	2 U	1.9 U	1.9 U	9.4 U	20 U
Gamma-Chlordane	UG/KG	48	6%	540	0	4	69	2.2 U	2 U	1.9 U	1.9 U	9.4 U	20 U
Heptachlor	UG/KG	0	0%	100	0	0	69	2.2 U	2 U	1.9 U	1.9 U	9.4 U	20 U
Heptachlor epoxide	UG/KG	180	17%	20	4	12	69	2.2 U	2 U	1.9 U	1.9 U	9.4 U	20 U
Methoxychlor	UG/KG	520	16%		0	11	69	22 U	20 U	19 U	19 U	94 U	200 U
Toxaphene	UG/KG	0	0%		0	0	69	220 U	200 U	190 U	190 U	940 U	380 U
Aroclor-1016	UG/KG	0	0%		0	0	69	42 U	39 U	37 U	37 U	37 U	38 U

Table A-4A
SURFACE SOIL SAMPLE RESULTS (0-2 ft.)
SEAD-71
SEAD-59 and SEAD-71 Phase II RI Report
Seneca Army Depot Activity

Facility	SEAD-71	SEAD-71	SEAD-71	SEAD-71	SEAD-71	SEAD-71
Location ID	TP71-2	TP71-3-1	WS-71-A-009-9	WS-71-B-009-6	WS-71-B-009-8	WS-71-D-009-13
Maxtrix	SOIL	SOIL	SOIL	SOIL	SOIL	SOIL
Sample ID	TP71-2-3	71002	WS-71-A-009-9	WS-71-B-009-6	WS-71-B-009-8	WS-71-D-009-13
Sample Depth to Top of Sample ⁽¹⁾	2	0	0	0	0	0
Sample Depth to Bottom of Sample ⁽¹⁾	3.3	8	0	0	0	0
Sample Date	6/7/1994	10/14/1997	5/6/2004	5/6/2004	5/6/2004	5/6/2004
QC Code	SA	SA	SA	SA	SA	SA
Study ID	ESI	RI PHASE 1 STEP 1	ENSR IRM	ENSR IRM	ENSR IRM	ENSR IRM
Sample Round			1	1	1	1

Parameter	Units	Maximum Value	Frequency of Detection	NYSDEC TAGM 4046 ⁽²⁾	Number of Exceedances	Number of Detects	Number of Analyses	Number of						
								Value (Q)	Value (Q)	Value (Q)	Value (Q)	Value (Q)	Value (Q)	
Aroclor-1221	UG/KG	0	0%		0	0	69	86 U	80 U	37 U	37 U	37 U	38 U	
Aroclor-1232	UG/KG	0	0%		0	0	69	42 U	39 U	37 U	37 U	37 U	38 U	
Aroclor-1242	UG/KG	0	0%		0	0	69	42 U	39 U	37 U	37 U	37 U	38 U	
Aroclor-1248	UG/KG	0	0%		0	0	69	42 U	39 U	37 U	37 U	37 U	38 U	
Aroclor-1254	UG/KG	0	0%	10000	0	0	69	42 U	39 U	37 U	37 U	37 U	38 U	
Aroclor-1260	UG/KG	200	4%	10000	0	3	69	42 U	39 U	37 U	37 U	37 U	38 U	
Metals														
Aluminum	MG/KG	18000	100%	19300	0	69	69	18000	8090 J	12600	11000	9750	9490	
Antimony	MG/KG	19.3	49%	5.9	5	34	69	0.23 UJ	0.56 UJ	2 J	9.2 J	5.9 J	11	
Arsenic	MG/KG	14.6	100%	8.2	5	69	69	7.6	4.3	7.4	6.9	5.5	5.4	
Barium	MG/KG	179	100%	300	0	69	69	108	51.3	92.4	95.1	83.6	89.2	
Beryllium	MG/KG	0.88	99%	1.1	0	68	69	0.88 J	0.21	0.7	0.57	0.49	0.17	
Cadmium	MG/KG	12.1	67%	2.3	4	46	69	0.45 J	0.08 U	0.49	0.46	0.44	0.28 U	
Calcium	MG/KG	295000	100%	121000	11	69	69	4260 J	134000	41100	44600	51800	45300	
Chromium	MG/KG	60.3	100%	29.6	5	69	69	25.8	12.9	19.4 J	22.8	17.5	17.5	
Cobalt	MG/KG	14.6	100%	30	0	69	69	14.6	11	12.5 J	9.7 J	8.9 J	8.5	
Copper	MG/KG	134	100%	33	21	69	69	36.2	15.2	30.3	59.9	98.2	77.7	
Cyanide	MG/KG	0	0%	0.35	0	24	69	0.54 U	0.65 U					
Iron	MG/KG	65100	100%	36500	2	69	69	32700	18000	28000 J	23000 J	19200 J	18800	
Lead	MG/KG	3470	100%	24.8	33	69	69	15.3	8.9 J	29.9 J	56.5 J	79.7 J	1010	
Magnesium	MG/KG	59300	100%	21500	6	69	69	6680	6760 J	7180 J	7330 J	15100 J	10100	
Manganese	MG/KG	1330	100%	1060	1	69	69	749	784 J	446 J	582 J	454 J	435	
Mercury	MG/KG	2.7	80%	0.1	10	55	69	0.04 J	0.05 U	0.05	0.68	0.31	0.08	
Nickel	MG/KG	110	100%	49	2	69	69	38.8	26.2	37.1 J	26.9 J	26.9 J	25.4	
Potassium	MG/KG	2180	100%	2380	0	69	69	1830 J	1120	1410	1110	1230	1170	
Selenium	MG/KG	1.8	19%	2	0	13	69	0.61 J	0.77 U	0.42 U	0.44 U	0.44 U	0.58 U	
Silver	MG/KG	2.2	39%	0.75	15	27	69	0.09 UJ	0.21 U	0.88	0.79	0.44 J	0.56 U	
Sodium	MG/KG	1040	97%	172	19	67	69	17.6 U	83.3 U	135	103	120	76.1	
Thallium	MG/KG	2.3	26%	0.7	10	18	69	0.34 U	1.2 U	0.21 U	0.22 U	0.22 U	0.7 J	
Vanadium	MG/KG	29.2	100%	150	0	69	69	29.2	15.1	20	18.9	17.8	19.9	
Zinc	MG/KG	3660	99%	110	17	68	69	71.8	57 J	75.5 J	122 J	104 J	114 J	

Note(s):

(1) - Historical sample depths are presented (I.e. prior to 2002 TCRA)

(2) - NYSDEC Technical and Administrative Guidance Memorandum (TAGM) HWR-94-4046

U = compound was not detected

J = the reported value is an estimated concentration

Table A-4A
SURFACE SOIL SAMPLE RESULTS (0-2 ft.)
SEAD-71
SEAD-59 and SEAD-71 Phase II RI Report
Seneca Army Depot Activity

Facility	SEAD-71	SEAD-71	SEAD-71	SEAD-71	SEAD-71	SEAD-71
Location ID	TP71-2	TP71-3-1	WS-71-A-009-9	WS-71-B-009-6	WS-71-B-009-8	WS-71-D-009-13
Maxtrix	SOIL	SOIL	SOIL	SOIL	SOIL	SOIL
Sample ID	TP71-2-3	71002	WS-71-A-009-9	WS-71-B-009-6	WS-71-B-009-8	WS-71-D-009-13
Sample Depth to Top of Sample ⁽¹⁾	2	0	0	0	0	0
Sample Depth to Bottom of Sample ⁽¹⁾	3.3	8	0	0	0	0
Sample Date	6/7/1994	10/14/1997	5/6/2004	5/6/2004	5/6/2004	5/6/2004
QC Code	SA	SA	SA	SA	SA	SA
Study ID	ESI	RI PHASE 1 STEP 1	ENSR IRM	ENSR IRM	ENSR IRM	ENSR IRM
Sample Round			1	1	1	1

Parameter	Units	Maximum Value	Frequency of Detection	NYSDEC TAGM 4046 ⁽²⁾	Number of Exceedances	Number of Detects	Number of Analyses	Value (Q)	Value (Q)	Value (Q)	Value (Q)	Value (Q)	Value (Q)

UJ = the compound was not detected; the associated reporting limit is approximate

R = the data was rejected in the data validating process

NJ = compound was "tentatively identified" and the associated numerical value is approximate

Table A-4A
SURFACE SOIL SAMPLE RESULTS (0-2 ft.)
SEAD-71
SEAD-59 and SEAD-71 Phase II RI Report
Seneca Army Depot Activity

Facility	SEAD-71	SEAD-71	SEAD-71
Location ID	WS-71-D-009-2	WS-71-E1-009-3	WS-71-E3-009-10
Maxtrix	SOIL	SOIL	SOIL
Sample ID	WS-71-D-009-2	WS-71-E1-009-3	WS-71-E3-009-10
Sample Depth to Top of Sample ⁽¹⁾	0	0	0
Sample Depth to Bottom of Sample ⁽¹⁾	0	0	0
Sample Date	5/6/2004	5/6/2004	5/6/2004
QC Code	SA	SA	SA
Study ID	ENSR IRM	ENSR IRM	ENSR IRM
Sample Round	1	1	1

Parameter	Units	Maximum Frequency of		NYSDEC TAGM 4046 ⁽²⁾	Number of Exceedances	Number of Detects	Number of Analyses	Value (Q)	Value (Q)	Value (Q)
		Value	Detection							
Volatile Organics										
1,1,1-Trichloroethane	UG/KG	3	3%	800	0	2	68	5.5 U	5.5 U	5.8 U
1,1,2,2-Tetrachloroethane	UG/KG	0	0%	600	0	0	64	5.5 U	5.5 U	5.8 U
1,1,2-Trichloro-1,2,2-Trifluoroethane	UG/KG	0	0%		0	0	44	5.5 U	5.5 U	5.8 U
1,1,2-Trichloroethane	UG/KG	0	0%		0	0	47			
1,1-Dichloroethane	UG/KG	0	0%	200	0	0	68	5.5 U	5.5 U	5.8 U
1,1-Dichloroethene	UG/KG	0	0%	400	0	0	68	5.5 U	5.5 U	5.8 U
1,2,3-Trichloropropane	UG/KG	0	0%		0	0	21	5.5 U	5.5 U	5.8 U
1,2,4-Trichlorobenzene	UG/KG	0	0%	3400	0	0	40	5.5 U	5.5 U	5.8 U
1,2-Dibromo-3-chloropropane	UG/KG	0	0%		0	0	19			
1,2-Dibromoethane	UG/KG	0	0%		0	0	23			
1,2-Dichlorobenzene	UG/KG	0	0%	7900	0	0	40	5.5 U	5.5 U	5.8 U
1,2-Dichloroethane	UG/KG	0	0%	100	0	0	68	5.5 U	5.5 U	5.8 U
1,2-Dichloroethene (total)	UG/KG	0	0%		0	0	24			
1,2-Dichloropropane	UG/KG	0	0%		0	0	47			
1,3-Dichlorobenzene	UG/KG	0	0%	1600	0	0	40	5.5 U	5.5 U	5.8 U
1,3-Dichloropropane	UG/KG	0	0%		0	0	21	5.5 U	5.5 U	5.8 U
1,4-Dichlorobenzene	UG/KG	0	0%	8500	0	0	40	5.5 U	5.5 U	5.8 U
Acetone	UG/KG	74	13%	200	0	9	68	22 U	22 U	23 UJ
Benzene	UG/KG	2	3%	60	0	2	68	5.5 U	5.5 U	5.8 U
Bromodichloromethane	UG/KG	0	0%		0	0	47			
Bromoform	UG/KG	0	0%		0	0	47			
Carbon disulfide	UG/KG	5	4%	2700	0	3	68	5.5 U	5.5 U	5.8 U
Carbon tetrachloride	UG/KG	0	0%	600	0	0	68	5.5 U	5.5 U	5.8 U
Chlorobenzene	UG/KG	0	0%	1700	0	0	68	5.5 U	5.5 U	5.8 U
Chlorodibromomethane	UG/KG	0	0%		0	0	68	5.5 U	5.5 U	5.8 U
Chloroethane	UG/KG	0	0%	1900	0	0	68	11 U	11 U	12 U
Chloroform	UG/KG	0	0%	300	0	0	68	5.5 U	5.5 U	5.8 U
Cis-1,2-Dichloroethene	UG/KG	0	0%		0	0	23			
Cis-1,3-Dichloropropene	UG/KG	0	0%		0	0	47			
Cyclohexane	UG/KG	4	9%		0	2	23			
Dichlorodifluoromethane	UG/KG	0	0%		0	0	23			
Ethyl benzene	UG/KG	4	3%	5500	0	2	68	5.5 U	5.5 U	5.8 U
Isopropylbenzene	UG/KG	0	0%		0	0	23			
Meta/Para Xylene	UG/KG	0	0%		0	0	21	5.5 U	5.5 U	5.8 U
Methyl Acetate	UG/KG	0	0%		0	0	23			
Methyl Tertbutyl Ether	UG/KG	0	0%		0	0	23			
Methyl bromide	UG/KG	0	0%		0	0	47			

Table A-4A
SURFACE SOIL SAMPLE RESULTS (0-2 ft.)
SEAD-71
SEAD-59 and SEAD-71 Phase II RI Report
Seneca Army Depot Activity

Facility	SEAD-71	SEAD-71	SEAD-71
Location ID	WS-71-D-009-2	WS-71-E1-009-3	WS-71-E3-009-10
Maxtrix	SOIL	SOIL	SOIL
Sample ID	WS-71-D-009-2	WS-71-E1-009-3	WS-71-E3-009-10
Sample Depth to Top of Sample ⁽¹⁾	0	0	0
Sample Depth to Bottom of Sample ⁽¹⁾	0	0	0
Sample Date	5/6/2004	5/6/2004	5/6/2004
QC Code	SA	SA	SA
Study ID	ENSR IRM	ENSR IRM	ENSR IRM
Sample Round	1	1	1

Parameter	Units	Maximum Frequency of		NYSDEC TAGM 4046 ⁽²⁾	Number of Exceedances	Number of Detects	Number of Analyses	Value (Q)	Value (Q)	Value (Q)
		Value	Detection							
Methyl butyl ketone	UG/KG	0	0%		0	0	47			
Methyl chloride	UG/KG	0	0%		0	0	47			
Methyl cyclohexane	UG/KG	6	13%		0	3	23			
Methyl ethyl ketone	UG/KG	0	0%	300	0	0	68	11 U	11 U	12 U
Methyl isobutyl ketone	UG/KG	0	0%	1000	0	0	68	11 U	11 U	12 U
Methylene chloride	UG/KG	11	12%	100	0	8	68	5.5 U	5.5 U	5.8 U
Ortho Xylene	UG/KG	0	0%		0	0	21	5.5 U	5.5 U	5.8 U
Styrene	UG/KG	1	2%		0	1	47			
Tetrachloroethene	UG/KG	33	1%	1400	0	1	68	5.5 U	5.5 U	5.8 U
Toluene	UG/KG	16	16%	1500	0	11	68	5.5 U	5.5 U	5.8 U
Total BTEX	MG/KG	11.6	100%		0	1	1			
Total Xylenes	UG/KG	11	11%	1200	0	5	44			
Trans-1,2-Dichloroethene	UG/KG	0	0%	300	0	0	44	5.5 U	5.5 U	5.8 U
Trans-1,3-Dichloropropene	UG/KG	0	0%		0	0	47			
Trichloroethene	UG/KG	0	0%	700	0	0	68	5.5 U	5.5 U	5.8 U
Trichlorofluoromethane	UG/KG	1	4%		0	1	23			
Vinyl chloride	UG/KG	0	0%	200	0	0	68	11 U	11 U	12 U
Semivolatile Organics										
1,1'-Biphenyl	UG/KG	0	0%		0	0	23			
1,2,4-Trichlorobenzene	UG/KG	0	0%	3400	0	0	24			
1,2-Dichlorobenzene	UG/KG	0	0%	7900	0	0	24			
1,3-Dichlorobenzene	UG/KG	0	0%	1600	0	0	24			
1,4-Dichlorobenzene	UG/KG	0	0%	8500	0	0	24			
2,2'-oxybis(1-Chloropropane)	UG/KG	0	0%		0	0	27			
2,4,5-Trichlorophenol	UG/KG	0	0%	100	0	0	69	1100 U	360 U	1900 U
2,4,6-Trichlorophenol	UG/KG	0	0%		0	0	69	1100 U	360 U	1900 U
2,4-Dichlorophenol	UG/KG	0	0%	400	0	0	69	1100 U	360 U	1900 U
2,4-Dimethylphenol	UG/KG	0	0%		0	0	47			
2,4-Dinitrophenol	UG/KG	0	0%	200	0	0	69	5600 U	1900 U	9800 UJ
2,4-Dinitrotoluene	UG/KG	880	1%		0	1	69	1100 U	360 U	1900 U
2,6-Dinitrotoluene	UG/KG	0	0%	1000	0	0	69	1100 U	360 U	1900 U
2-Chloronaphthalene	UG/KG	0	0%		0	0	47			
2-Chlorophenol	UG/KG	0	0%	800	0	0	69	1100 U	360 U	1900 U
2-Methylnaphthalene	UG/KG	19000	22%	36400	0	15	69	1100 U	360 U	1900 U
2-Methylphenol	UG/KG	0	0%	100	0	0	69	1100 U	360 U	1900 U
2-Nitroaniline	UG/KG	0	0%	430	0	0	69	5600 U	1900 U	9800 U
2-Nitrophenol	UG/KG	0	0%	330	0	0	69	1100 U	360 U	1900 U
3,3'-Dichlorobenzidine	UG/KG	0	0%		0	0	69	1100 U	360 U	1900 U

Table A-4A
SURFACE SOIL SAMPLE RESULTS (0-2 ft.)
SEAD-71
SEAD-59 and SEAD-71 Phase II RI Report
Seneca Army Depot Activity

Facility	SEAD-71	SEAD-71	SEAD-71
Location ID	WS-71-D-009-2	WS-71-E1-009-3	WS-71-E3-009-10
Maxtrix	SOIL	SOIL	SOIL
Sample ID	WS-71-D-009-2	WS-71-E1-009-3	WS-71-E3-009-10
Sample Depth to Top of Sample ⁽¹⁾	0	0	0
Sample Depth to Bottom of Sample ⁽¹⁾	0	0	0
Sample Date	5/6/2004	5/6/2004	5/6/2004
QC Code	SA	SA	SA
Study ID	ENSR IRM	ENSR IRM	ENSR IRM
Sample Round	1	1	1

Parameter	Units	Maximum Frequency of		NYSDEC TAGM 4046 ⁽²⁾	Number of Exceedances	Number of Detects	Number of Analyses	Value (Q)	Value (Q)	Value (Q)
		Value	Detection							
3-Nitroaniline	UG/KG	0	0%	500	0	0	69	5600 U	1900 U	9800 U
4,6-Dinitro-2-methylphenol	UG/KG	0	0%		0	0	47			
4-Bromophenyl phenyl ether	UG/KG	0	0%		0	0	47			
4-Chloro-3-methylphenol	UG/KG	0	0%	240	0	0	69	1100 U	360 U	1900 U
4-Chloroaniline	UG/KG	0	0%	220	0	0	69	1100 U	360 U	1900 U
4-Chlorophenyl phenyl ether	UG/KG	0	0%		0	0	47			
4-Methylphenol	UG/KG	0	0%	900	0	0	69	1100 U	360 U	1900 U
4-Nitroaniline	UG/KG	75	2%		0	1	47			
4-Nitrophenol	UG/KG	0	0%	100	0	0	69	5600 U	1900 U	9800 U
Acenaphthene	UG/KG	42000	42%	50000	0	29	69	1100 U	43 J	1900 U
Acenaphthylene	UG/KG	1800	28%	41000	0	19	69	230 J	48 J	1900 U
Acetophenone	UG/KG	0	0%		0	0	23			
Aniline	UG/KG	0	0%		0	0	22	1100 U	360 U	1900 U
Anthracene	UG/KG	100000	59%	50000	3	41	69	370 J	110 J	1900 U
Atrazine	UG/KG	0	0%		0	0	23			
Benzaldehyde	UG/KG	0	0%		0	0	23			
Benzo(a)anthracene	UG/KG	150000	77%	224	40	53	69	1300	390	1900 U
Benzo(a)pyrene	UG/KG	120000	77%	61	47	53	69	1500	330 J	1900 U
Benzo(b)fluoranthene	UG/KG	88000	78%	1100	23	54	69	1400	390	1900 U
Benzo(ghi)perylene	UG/KG	62000	70%	50000	1	48	69	910 J	270 J	1900 U
Benzo(k)fluoranthene	UG/KG	130000	61%	1100	20	42	69	1300	370 J	1900 U
Benzoic Acid	UG/KG	0	0%	2700	0	0	22	5600 U	1900 U	9800 U
Bis(2-Chloroethoxy)methane	UG/KG	0	0%		0	0	47			
Bis(2-Chloroethyl)ether	UG/KG	0	0%		0	0	47			
Bis(2-Chloroisopropyl)ether	UG/KG	0	0%		0	0	20			
Bis(2-Ethylhexyl)phthalate	UG/KG	140	9%	50000	0	6	69	1100 U	360 U	1900 U
Butylbenzylphthalate	UG/KG	0	0%	50000	0	0	69	1100 U	360 U	1900 U
Caprolactam	UG/KG	0	0%		0	0	23			
Carbazole	UG/KG	77000	57%		0	27	47			
Chrysene	UG/KG	150000	81%	400	37	56	69	1600	510	1900 U
Di-n-butylphthalate	UG/KG	140	6%	8100	0	4	69	1100 U	360 U	1900 U
Di-n-octylphthalate	UG/KG	0	0%	50000	0	0	69	1100 U	360 U	1900 U
Dibenz(a,h)anthracene	UG/KG	25000	58%	14	40	40	69	310 J	86 J	1900 U
Dibenzofuran	UG/KG	38000	39%	6200	4	27	69	1100 U	360 U	1900 U
Diethyl phthalate	UG/KG	0	0%	7100	0	0	69	1100 U	360 U	1900 U
Dimethylphthalate	UG/KG	0	0%	2000	0	0	69	1100 U	360 U	1900 U
Fluoranthene	UG/KG	440000	84%	50000	6	58	69	2800	800	270 J
Fluorene	UG/KG	62000	41%	50000	1	28	69	1100 U	360 U	1900 U

Table A-4A
SURFACE SOIL SAMPLE RESULTS (0-2 ft.)
SEAD-71
SEAD-59 and SEAD-71 Phase II RI Report
Seneca Army Depot Activity

Facility	SEAD-71	SEAD-71	SEAD-71
Location ID	WS-71-D-009-2	WS-71-E1-009-3	WS-71-E3-009-10
Maxtrix	SOIL	SOIL	SOIL
Sample ID	WS-71-D-009-2	WS-71-E1-009-3	WS-71-E3-009-10
Sample Depth to Top of Sample ⁽¹⁾	0	0	0
Sample Depth to Bottom of Sample ⁽¹⁾	0	0	0
Sample Date	5/6/2004	5/6/2004	5/6/2004
QC Code	SA	SA	SA
Study ID	ENSR IRM	ENSR IRM	ENSR IRM
Sample Round	1	1	1

Parameter	Units	Maximum Frequency of		NYSDEC TAGM 4046 ⁽²⁾	Number of Exceedances	Number of Detects	Number of Analyses	Value (Q)	Value (Q)	Value (Q)
		Value	Detection							
Hexachlorobenzene	UG/KG	0	0%	410	0	0	69	1100 U	360 U	1900 U
Hexachlorobutadiene	UG/KG	0	0%		0	0	69	1100 U	360 U	1900 U
Hexachlorocyclopentadiene	UG/KG	0	0%		0	0	47			
Hexachloroethane	UG/KG	0	0%		0	0	69	1100 U	360 U	1900 U
Indeno(1,2,3-cd)pyrene	UG/KG	65000	70%	3200	11	48	69	880 J	250 J	1900 U
Isophorone	UG/KG	0	0%	4400	0	0	69	1100 U	360 U	1900 U
N-Nitrosodiphenylamine	UG/KG	0	0%		0	0	47			
N-Nitrosodipropylamine	UG/KG	0	0%		0	0	47			
Naphthalene	UG/KG	46000	22%	13000	1	15	69	1100 U	360 U	1900 U
Nitrobenzene	UG/KG	0	0%	200	0	0	69	1100 U	360 U	1900 U
Pentachlorophenol	UG/KG	0	0%	1000	0	0	69	5600 U	1900 U	9800 U
Phenanthrene	UG/KG	290000	78%	50000	5	54	69	980 J	300 J	1900 U
Phenol	UG/KG	4.5	1%	30	0	1	69	1100 U	360 U	1900 U
Pyrene	UG/KG	280000	81%	50000	6	56	69	2200	660	1900 U
Pyridine	UG/KG	0	0%		0	0	22	5600 U	1900 U	9800 U
Pesticides/PCBs										
4,4'-DDD	UG/KG	240	26%	2900	0	18	69	18 U	18 U	19 U
4,4'-DDE	UG/KG	810	42%	2100	0	29	69	54 J	18 U	19 U
4,4'-DDT	UG/KG	1300	51%	2100	0	35	69	42	25	19 U
Aldrin	UG/KG	0	0%	41	0	0	69	9.3 U	9.4 U	9.8 U
Alpha-BHC	UG/KG	18	7%	110	0	5	69	9.3 U	9.4 U	9.8 U
Alpha-Chlordane	UG/KG	2	1%		0	1	69	9.3 U	9.4 U	9.8 U
Beta-BHC	UG/KG	35	9%	200	0	6	69	9.3 U	9.4 U	9.8 U
Delta-BHC	UG/KG	0	0%	300	0	0	69	9.3 U	9.4 U	9.8 U
Dieldrin	UG/KG	3.4	3%	44	0	2	69	18 U	18 U	19 U
Endosulfan I	UG/KG	15	10%	900	0	7	69	9.3 U	9.4 U	9.8 U
Endosulfan II	UG/KG	52	4%	900	0	3	69	18 U	18 U	19 U
Endosulfan sulfate	UG/KG	110	16%	1000	0	11	69	18 U	18 U	19 U
Endrin	UG/KG	120	14%	100	1	10	69	18 U	18 U	19 U
Endrin aldehyde	UG/KG	120	23%		0	16	69	18 U	18 U	19 U
Endrin ketone	UG/KG	180	22%		0	15	69	18 U	18 U	19 U
Gamma-BHC/Lindane	UG/KG	0	0%	60	0	0	69	9.3 U	9.4 U	9.8 U
Gamma-Chlordane	UG/KG	48	6%	540	0	4	69	9.3 U	9.4 U	9.8 U
Heptachlor	UG/KG	0	0%	100	0	0	69	9.3 U	9.4 U	9.8 U
Heptachlor epoxide	UG/KG	180	17%	20	4	12	69	9.3 U	9.4 U	9.8 U
Methoxychlor	UG/KG	520	16%		0	11	69	93 U	94 U	98 U
Toxaphene	UG/KG	0	0%		0	0	69	180 U	180 U	190 U
Aroclor-1016	UG/KG	0	0%		0	0	69	36 U	36 U	38 U

Table A-4A
SURFACE SOIL SAMPLE RESULTS (0-2 ft.)
SEAD-71
SEAD-59 and SEAD-71 Phase II RI Report
Seneca Army Depot Activity

Facility	SEAD-71	SEAD-71	SEAD-71
Location ID	WS-71-D-009-2	WS-71-E1-009-3	WS-71-E3-009-10
Maxtrix	SOIL	SOIL	SOIL
Sample ID	WS-71-D-009-2	WS-71-E1-009-3	WS-71-E3-009-10
Sample Depth to Top of Sample ⁽¹⁾	0	0	0
Sample Depth to Bottom of Sample ⁽¹⁾	0	0	0
Sample Date	5/6/2004	5/6/2004	5/6/2004
QC Code	SA	SA	SA
Study ID	ENSR IRM	ENSR IRM	ENSR IRM
Sample Round	1	1	1

Parameter	Units	Maximum Frequency of		NYSDEC TAGM 4046 ⁽²⁾	Number of Exceedances	Number of Detects	Number of Analyses	Value (Q)	Value (Q)	Value (Q)
		Value	Detection							
Aroclor-1221	UG/KG	0	0%		0	0	69	36 U	36 U	38 U
Aroclor-1232	UG/KG	0	0%		0	0	69	36 U	36 U	38 U
Aroclor-1242	UG/KG	0	0%		0	0	69	36 U	36 U	38 U
Aroclor-1248	UG/KG	0	0%		0	0	69	36 U	36 U	38 U
Aroclor-1254	UG/KG	0	0%	10000	0	0	69	36 U	36 U	38 U
Aroclor-1260	UG/KG	200	4%	10000	0	3	69	36 U	36 U	38 U
Metals										
Aluminum	MG/KG	18000	100%	19300	0	69	69	10100	13400	12600
Antimony	MG/KG	19.3	49%	5.9	5	34	69	3.2 UJ	3.1 UJ	3.4 U
Arsenic	MG/KG	14.6	100%	8.2	5	69	69	5.6	5.8	5 J
Barium	MG/KG	179	100%	300	0	69	69	75.3	87	79.8
Beryllium	MG/KG	0.88	99%	1.1	0	68	69	0.28 J	0.51 J	0.27
Cadmium	MG/KG	12.1	67%	2.3	4	46	69	0.42 J	0.3 J	0.56 J
Calcium	MG/KG	295000	100%	121000	11	69	69	48600 J	20200 J	23600 J
Chromium	MG/KG	60.3	100%	29.6	5	69	69	18.1	20.6	18.1
Cobalt	MG/KG	14.6	100%	30	0	69	69	9.1	10.7	9.3
Copper	MG/KG	134	100%	33	21	69	69	33.1	102	21.1
Cyanide	MG/KG	0	0%	0.35	0	0	24			
Iron	MG/KG	65100	100%	36500	2	69	69	24800 J	25800 J	23300
Lead	MG/KG	3470	100%	24.8	33	69	69	97.5 J	19.2 J	15.1
Magnesium	MG/KG	59300	100%	21500	6	69	69	9530 J	5510 J	7680
Manganese	MG/KG	1330	100%	1060	1	69	69	516	618	617
Mercury	MG/KG	2.7	80%	0.1	10	55	69	0.06	0.04	0.04
Nickel	MG/KG	110	100%	49	2	69	69	24.1	29.2	24.7
Potassium	MG/KG	2180	100%	2380	0	69	69	1300	1160	1030
Selenium	MG/KG	1.8	19%	2	0	13	69	0.54 U	0.52 U	0.57 U
Silver	MG/KG	2.2	39%	0.75	15	27	69	0.54 U	0.52 U	0.57 U
Sodium	MG/KG	1040	97%	172	19	67	69	78.1	52.1	57.4
Thallium	MG/KG	2.3	26%	0.7	10	18	69	0.6 J	0.77 J	0.57 U
Vanadium	MG/KG	29.2	100%	150	0	69	69	18.2	20	19.3
Zinc	MG/KG	3660	99%	110	17	68	69	93.8 J	89.3 J	67.9 J

Note(s):

- (1) - Historical sample depths are presented (I.e. prior to 2002 TCRA)
- (2) - NYSDEC Technical and Administrative Guidance Memorandum (TAGM) HWR-94-4046

U = compound was not detected

J = the reported value is an estimated concentration

Table A-4A
SURFACE SOIL SAMPLE RESULTS (0-2 ft.)
SEAD-71
SEAD-59 and SEAD-71 Phase II RI Report
Seneca Army Depot Activity

Facility	SEAD-71	SEAD-71	SEAD-71
Location ID	WS-71-D-009-2	WS-71-E1-009-3	WS-71-E3-009-10
Maxtrix	SOIL	SOIL	SOIL
Sample ID	WS-71-D-009-2	WS-71-E1-009-3	WS-71-E3-009-10
Sample Depth to Top of Sample ⁽¹⁾	0	0	0
Sample Depth to Bottom of Sample ⁽¹⁾	0	0	0
Sample Date	5/6/2004	5/6/2004	5/6/2004
QC Code	SA	SA	SA
Study ID	ENSR IRM	ENSR IRM	ENSR IRM
Sample Round	1	1	1

Parameter	Units	Maximum Value	Frequency of Detection	NYSDEC TAGM 4046 ⁽²⁾	Number of Exceedances	Number of Detects	Number of Analyses	Value (Q)	Value (Q)	Value (Q)

UJ = the compound was not detected; the associated reporting limit is approximate

R = the data was rejected in the data validating process

NJ = compound was "tentatively identified" and the associated numerical value is approximate

Table A-4B
SUBSURFACE SOIL SAMPLE RESULTS (2-15 ft.)
SEAD-71
SEAD-59 and SEAD-71 Phase II RI Report
Seneca Army Depot Activity

Facility	SEAD-71	SEAD-71	SEAD-71	SEAD-71	SEAD-71	SEAD-71
Location ID	TP71-1	TP71-1	TP71-1	TP71-1	TP71-3-2	TP71-4-2
Maxtrix	SOIL	SOIL	SOIL	SOIL	SOIL	SOIL
Sample ID	TP71-1-1	TP71-1-2	TP71-1-3	TP71-1-4	71003	71006
Sample Depth to Top of Sample	3	3	3	4	10.5	10
Sample Depth to Bottom of Sample	3	3	3	4	11	10.5
Sample Date	6/7/1994	6/7/1994	6/7/1994	6/7/1994	10/14/1997	10/14/1997
QC Code	SA	SA	SA	SA	SA	SA
Study ID	ESI	ESI	ESI	ESI	RI PHASE 1 STEP 1	RI PHASE 1 STEP 1

Parameter	Units	Maximum Value	Frequency of Detection	NYSDEC TAGM 4046 ⁽²⁾	Number of Exceedances	Number of Detects	Number of Analyses	Value (Q)					
								Value (Q)	Value (Q)	Value (Q)	Value (Q)	Value (Q)	Value (Q)
Volatile Organics													
1,1,1-Trichloroethane	UG/KG	23	63%	800	0	5	8	4 J	7 J	10 J	23	110 U	12 U
1,1,2,2-Tetrachloroethane	UG/KG	0	0%	600	0	0	8	12 U	12 U	11 U	12 U	110 U	12 U
1,1,2-Trichloro-1,2,2-Trifluoroethane	UG/KG	0	0%		0	0	0						
1,1,2-Trichloroethane	UG/KG	0	0%		0	0	8	12 U	12 U	11 U	12 U	110 U	12 U
1,1-Dichloroethane	UG/KG	0	0%	200	0	0	8	12 U	12 U	11 U	12 U	110 U	12 U
1,1-Dichloroethene	UG/KG	0	0%	400	0	0	8	12 U	12 U	11 U	12 U	110 U	12 U
1,2,3-Trichloropropane	UG/KG	0	0%		0	0	0						
1,2,4-Trichlorobenzene	UG/KG	0	0%	3400	0	0	0						
1,2-Dibromo-3-chloropropane	UG/KG	0	0%		0	0	0						
1,2-Dibromoethane	UG/KG	0	0%		0	0	0						
1,2-Dichlorobenzene	UG/KG	0	0%	7900	0	0	0						
1,2-Dichloroethane	UG/KG	0	0%	100	0	0	8	12 U	12 U	11 U	12 U	110 U	12 U
1,2-Dichloroethene (total)	UG/KG	0	0%		0	0	8	12 U	12 U	11 U	12 U	110 U	12 U
1,2-Dichloropropane	UG/KG	0	0%		0	0	8	12 U	12 U	11 U	12 U	110 U	12 U
1,3-Dichlorobenzene	UG/KG	0	0%	1600	0	0	0						
1,3-Dichloropropane	UG/KG	0	0%		0	0	0						
1,4-Dichlorobenzene	UG/KG	0	0%	8500	0	0	0						
Acetone	UG/KG	0	0%	200	0	0	8	12 U	12 U	11 U	12 U	110 U	12 U
Benzene	UG/KG	0	0%	60	0	0	8	12 U	12 U	11 U	12 U	110 U	12 U
Bromodichloromethane	UG/KG	0	0%		0	0	8	12 U	12 U	11 U	12 U	110 U	12 U
Bromoform	UG/KG	0	0%		0	0	8	12 U	12 U	11 U	12 U	110 U	12 U
Carbon disulfide	UG/KG	0	0%	2700	0	0	8	12 U	12 U	11 U	12 U	110 U	12 U
Carbon tetrachloride	UG/KG	0	0%	600	0	0	8	12 U	12 U	11 U	12 U	110 U	12 U
Chlorobenzene	UG/KG	0	0%	1700	0	0	8	12 U	12 U	11 U	12 U	110 U	12 U
Chlorodibromomethane	UG/KG	0	0%		0	0	8	12 U	12 U	11 U	12 U	110 U	12 U
Chloroethane	UG/KG	0	0%	1900	0	0	8	12 U	12 U	11 U	12 U	110 U	12 U
Chloroform	UG/KG	0	0%	300	0	0	8	12 U	12 U	11 U	12 U	110 U	12 U
Cis-1,2-Dichloroethene	UG/KG	0	0%		0	0	0						
Cis-1,3-Dichloropropene	UG/KG	0	0%		0	0	8	12 U	12 U	11 U	12 U	110 U	12 U
Cyclohexane	UG/KG	0	0%		0	0	0						
Dichlorodifluoromethane	UG/KG	0	0%		0	0	0						
Ethyl benzene	UG/KG	0	0%	5500	0	0	8	12 U	12 U	11 U	12 U	110 U	12 U
Isopropylbenzene	UG/KG	0	0%		0	0	0						
Meta/Para Xylene	UG/KG	0	0%		0	0	0						
Methyl Acetate	UG/KG	0	0%		0	0	0						
Methyl Tertbutyl Ether	UG/KG	0	0%		0	0	0						
Methyl bromide	UG/KG	0	0%		0	0	8	12 U	12 U	11 U	12 U	110 U	12 U
Methyl butyl ketone	UG/KG	0	0%		0	0	8	12 U	12 U	11 U	12 U	110 U	12 U

Table A-4B
SUBSURFACE SOIL SAMPLE RESULTS (2-15 ft.)
SEAD-71
SEAD-59 and SEAD-71 Phase II RI Report
Seneca Army Depot Activity

Facility	SEAD-71	SEAD-71	SEAD-71	SEAD-71	SEAD-71	SEAD-71
Location ID	TP71-1	TP71-1	TP71-1	TP71-1	TP71-3-2	TP71-4-2
Maxtrix	SOIL	SOIL	SOIL	SOIL	SOIL	SOIL
Sample ID	TP71-1-1	TP71-1-2	TP71-1-3	TP71-1-4	71003	71006
Sample Depth to Top of Sample	3	3	3	4	10.5	10
Sample Depth to Bottom of Sample	3	3	3	4	11	10.5
Sample Date	6/7/1994	6/7/1994	6/7/1994	6/7/1994	10/14/1997	10/14/1997
QC Code	SA	SA	SA	SA	SA	SA
Study ID	ESI	ESI	ESI	ESI	RI PHASE 1 STEP 1	RI PHASE 1 STEP 1

Parameter	Units	Maximum Frequency of		NYSDEC TAGM 4046 ⁽²⁾	Number of Exceedances	Number of Detects	Number of Analyses	Value (Q)	Value (Q)	Value (Q)	Value (Q)	Value (Q)	Value (Q)
		Value	Detection										
Methyl chloride	UG/KG	0	0%		0	0	8	12 U	12 U	11 U	12 U	110 U	12 U
Methyl cyclohexane	UG/KG	0	0%		0	0	0						
Methyl ethyl ketone	UG/KG	0	0%	300	0	0	8	12 U	12 U	11 U	12 U	110 U	12 U
Methyl isobutyl ketone	UG/KG	0	0%	1000	0	0	8	12 U	12 U	11 U	12 U	110 U	12 U
Methylene chloride	UG/KG	2	50%	100	0	4	8	2 J	2 J	2 J	2 J	110 U	12 U
Ortho Xylene	UG/KG	0	50%		0	0	0						
Styrene	UG/KG	0	0%		0	0	8	12 U	12 U	11 U	12 U	110 U	12 U
Tetrachloroethene	UG/KG	3	38%	1400	0	3	8	1 J	1 J	3 J	12 U	110 U	12 U
Toluene	UG/KG	0	0%	1500	0	0	8	12 U	12 U	11 U	12 U	110 U	12 U
Total BTEX	MG/KG	3.5	100%		0	3	3						3.5
Total Xylenes	UG/KG	96	13%	1200	0	1	8	12 U	12 U	11 U	12 U	96 J	12 U
Trans-1,2-Dichloroethene	UG/KG	0	13%	300	0	0	0						
Trans-1,3-Dichloropropene	UG/KG	0	0%		0	0	8	12 U	12 U	11 U	12 U	110 U	12 U
Trichloroethene	UG/KG	0	0%	700	0	0	8	12 U	12 U	11 U	12 U	110 U	12 U
Trichlorofluoromethane	UG/KG	0	0%		0	0	0						
Vinyl chloride	UG/KG	0	0%	200	0	0	8	12 U	12 U	11 U	12 U	110 U	12 U
Semivolatile Organics													
1,1'-Biphenyl	UG/KG	0	0%		0	0	0						
1,2,4-Trichlorobenzene	UG/KG	0	0%	3400	0	0	8	19000 U	500 U	370 U	390 U	760 U	78 U
1,2-Dichlorobenzene	UG/KG	0	0%	7900	0	0	8	19000 U	500 U	370 U	390 U	760 U	78 U
1,3-Dichlorobenzene	UG/KG	0	0%	1600	0	0	8	19000 U	500 U	370 U	390 U	760 U	78 U
1,4-Dichlorobenzene	UG/KG	0	0%	8500	0	0	8	19000 U	500 U	370 U	390 U	760 U	78 U
2,2'-oxybis(1-Chloropropane)	UG/KG	0	0%		0	0	4	19000 U	500 U	370 U	390 U		
2,4,5-Trichlorophenol	UG/KG	0	0%	100	0	0	8	45000 U	1200 U	900 U	940 U	1800 U	190 U
2,4,6-Trichlorophenol	UG/KG	0	0%		0	0	8	19000 U	500 U	370 U	390 U	760 U	78 U
2,4-Dichlorophenol	UG/KG	0	0%	400	0	0	8	19000 U	500 U	370 U	390 U	760 U	78 U
2,4-Dimethylphenol	UG/KG	0	0%		0	0	8	19000 U	500 U	370 U	390 U	760 U	78 U
2,4-Dinitrophenol	UG/KG	0	0%	200	0	0	8	45000 U	1200 U	900 U	940 U	1800 U	190 U
2,4-Dinitrotoluene	UG/KG	0	0%		0	0	8	19000 U	500 U	370 U	390 U	760 U	78 U
2,6-Dinitrotoluene	UG/KG	0	0%	1000	0	0	8	19000 U	500 U	370 U	390 U	760 U	78 U
2-Chloronaphthalene	UG/KG	0	0%		0	0	8	19000 U	500 U	370 U	390 U	760 U	78 U
2-Chlorophenol	UG/KG	0	0%	800	0	0	8	19000 U	500 U	370 U	390 U	760 U	78 U
2-Methylnaphthalene	UG/KG	31000	25%	36400	0	2	8	19000 U	29 J	370 U	390 U	31000 J	78 U
2-Methylphenol	UG/KG	0	0%	100	0	0	8	19000 U	500 U	370 U	390 U	760 U	78 U
2-Nitroaniline	UG/KG	0	0%	430	0	0	8	45000 U	1200 U	900 U	940 U	1800 U	190 U
2-Nitrophenol	UG/KG	0	0%	330	0	0	8	19000 U	500 U	370 U	390 U	760 U	78 U
3,3'-Dichlorobenzidine	UG/KG	0	0%		0	0	8	19000 U	500 U	370 U	390 U	760 U	78 U
3-Nitroaniline	UG/KG	0	0%	500	0	0	8	45000 U	1200 U	900 U	940 U	1800 U	190 U
4,6-Dinitro-2-methylphenol	UG/KG	0	0%		0	0	8	45000 U	1200 U	900 U	940 U	1800 U	190 U

Table A-4B
SUBSURFACE SOIL SAMPLE RESULTS (2-15 ft.)
SEAD-71
SEAD-59 and SEAD-71 Phase II RI Report
Seneca Army Depot Activity

Facility	SEAD-71	SEAD-71	SEAD-71	SEAD-71	SEAD-71	SEAD-71
Location ID	TP71-1	TP71-1	TP71-1	TP71-1	TP71-3-2	TP71-4-2
Maxtrix	SOIL	SOIL	SOIL	SOIL	SOIL	SOIL
Sample ID	TP71-1-1	TP71-1-2	TP71-1-3	TP71-1-4	71003	71006
Sample Depth to Top of Sample	3	3	3	4	10.5	10
Sample Depth to Bottom of Sample	3	3	3	4	11	10.5
Sample Date	6/7/1994	6/7/1994	6/7/1994	6/7/1994	10/14/1997	10/14/1997
QC Code	SA	SA	SA	SA	SA	SA
Study ID	ESI	ESI	ESI	ESI	RI PHASE 1 STEP 1	RI PHASE 1 STEP 1

Parameter	Units	Maximum Value	Frequency of Detection	NYSDEC TAGM 4046 ⁽²⁾	Number of Exceedances	Number of Detects	Number of Analyses	Number of							
								Value (Q)	Value (Q)	Value (Q)	Value (Q)	Value (Q)	Value (Q)	Value (Q)	Value (Q)
4-Bromophenyl phenyl ether	UG/KG	0	0%		0	0	8	19000 U	500 U	370 U	390 U	760 U	78 U		
4-Chloro-3-methylphenol	UG/KG	0	0%	240	0	0	8	19000 U	500 U	370 U	390 U	760 U	78 U		
4-Chloroaniline	UG/KG	0	0%	220	0	0	8	19000 U	500 U	370 U	390 U	760 U	78 U		
4-Chlorophenyl phenyl ether	UG/KG	0	0%		0	0	8	19000 U	500 U	370 U	390 U	760 U	78 U		
4-Methylphenol	UG/KG	0	0%	900	0	0	8	19000 U	500 U	370 U	390 U	760 U	78 U		
4-Nitroaniline	UG/KG	0	0%		0	0	8	45000 U	1200 U	900 U	940 U	1800 U	190 UJ		
4-Nitrophenol	UG/KG	0	0%	100	0	0	8	45000 U	1200 U	900 U	940 U	1800 U	190 U		
Acenaphthene	UG/KG	13000	63%	50000	0	5	8	5800 J	280 J	76 J	38 J	13000 J	78 U		
Acenaphthylene	UG/KG	340	13%	41000	0	1	8	19000 U	500 U	370 U	390 U	340 J	78 U		
Acetophenone	UG/KG	0	13%		0	0	0								
Aniline	UG/KG	0	13%		0	0	0								
Anthracene	UG/KG	11000	63%	50000	0	5	8	11000 J	560	120 J	59 J	590 J	78 U		
Atrazine	UG/KG	0	63%		0	0	0								
Benzaldehyde	UG/KG	0	63%		0	0	0								
Benzo(a)anthracene	UG/KG	37000	88%	224	4	7	8	37000	1200	660	180 J	240 J	78 U		
Benzo(a)pyrene	UG/KG	22000	88%	61	5	7	8	22000	750	630	160 J	160 J	78 U		
Benzo(b)fluoranthene	UG/KG	26000	88%	1100	1	7	8	26000	930	710	130 J	130 J	78 U		
Benzo(ghi)perylene	UG/KG	10000	75%	50000	0	6	8	10000 J	500	500	82 J	76 J	78 U		
Benzo(k)fluoranthene	UG/KG	15000	88%	1100	1	7	8	15000 J	570	490	140 J	98 J	78 U		
Benzoic Acid	UG/KG	0	88%	2700	0	0	0								
Bis(2-Chloroethoxy)methane	UG/KG	0	0%		0	0	8	19000 U	500 U	370 U	390 U	760 U	78 U		
Bis(2-Chloroethyl)ether	UG/KG	0	0%		0	0	8	19000 U	500 U	370 U	390 U	760 U	78 U		
Bis(2-Chloroisopropyl)ether	UG/KG	0	0%		0	0	4								
Bis(2-Ethylhexyl)phthalate	UG/KG	15	38%	50000	0	3	8	19000 U	500 U	370 U	390 U	760 U	7.8 J		
Butylbenzylphthalate	UG/KG	0	0%	50000	0	0	8	19000 U	500 U	370 U	390 U	760 U	78 U		
Caprolactam	UG/KG	0	0%		0	0	0								
Carbazole	UG/KG	9500	75%		0	6	8	9500 J	360 J	100 J	30 J	380 J	78 U		
Chrysene	UG/KG	36000	88%	400	3	7	8	36000	1000	750	220 J	290 J	78 U		
Di-n-butylphthalate	UG/KG	0	0%	8100	0	0	8	19000 U	500 U	370 U	390 U	760 U	78 U		
Di-n-octylphthalate	UG/KG	0	0%	50000	0	0	8	19000 U	500 U	370 U	390 U	760 U	78 U		
Dibenz(a,h)anthracene	UG/KG	9800	63%	14	4	5	8	9800 J	190 J	320 J	38 J	760 U	78 U		
Dibenzofuran	UG/KG	11000	25%	6200	1	2	8	19000 U	120 J	370 U	390 U	11000 J	78 U		
Diethyl phthalate	UG/KG	0	0%	7100	0	0	8	19000 U	500 U	370 U	390 U	760 U	78 U		
Dimethylphthalate	UG/KG	0	0%	2000	0	0	8	19000 U	500 U	370 U	390 U	760 U	78 U		
Fluoranthene	UG/KG	88000	88%	50000	1	7	8	88000	2600	1400	330 J	1900	78 U		
Fluorene	UG/KG	4100	50%	50000	0	4	8	2800 J	230 J	56 J	390 U	4100	78 U		
Hexachlorobenzene	UG/KG	0	0%	410	0	0	8	19000 U	500 U	370 U	390 U	760 U	78 U		
Hexachlorobutadiene	UG/KG	0	0%		0	0	8	19000 U	500 U	370 U	390 U	760 U	78 U		
Hexachlorocyclopentadiene	UG/KG	0	0%		0	0	8	19000 U	500 U	370 U	390 U	760 U	78 U		

Table A-4B
SUBSURFACE SOIL SAMPLE RESULTS (2-15 ft.)
SEAD-71
SEAD-59 and SEAD-71 Phase II RI Report
Seneca Army Depot Activity

Facility	SEAD-71	SEAD-71	SEAD-71	SEAD-71	SEAD-71	SEAD-71
Location ID	TP71-1	TP71-1	TP71-1	TP71-1	TP71-3-2	TP71-4-2
Maxtrix	SOIL	SOIL	SOIL	SOIL	SOIL	SOIL
Sample ID	TP71-1-1	TP71-1-2	TP71-1-3	TP71-1-4	71003	71006
Sample Depth to Top of Sample	3	3	3	4	10.5	10
Sample Depth to Bottom of Sample	3	3	3	4	11	10.5
Sample Date	6/7/1994	6/7/1994	6/7/1994	6/7/1994	10/14/1997	10/14/1997
QC Code	SA	SA	SA	SA	SA	SA
Study ID	ESI	ESI	ESI	ESI	RI PHASE 1 STEP 1	RI PHASE 1 STEP 1

Parameter	Units	Maximum Value	Frequency of Detection	NYSDEC TAGM 4046 ⁽²⁾	Number of Exceedances	Number of Detects	Number of Analyses	Value (Q)					
								Value (Q)	Value (Q)	Value (Q)	Value (Q)	Value (Q)	Value (Q)
Hexachloroethane	UG/KG	0	0%		0	0	8	19000 U	500 U	370 U	390 U	760 U	78 U
Indeno(1,2,3-cd)pyrene	UG/KG	12000	75%	3200	1	6	8	12000 J	390 J	520	88 J	56 J	78 U
Isophorone	UG/KG	0	0%	4400	0	0	8	19000 U	500 U	370 U	390 U	760 U	78 U
N-Nitrosodiphenylamine	UG/KG	0	0%		0	0	8	19000 U	500 U	370 U	390 U	760 U	78 U
N-Nitrosodipropylamine	UG/KG	0	0%		0	0	8	19000 U	500 U	370 U	390 U	760 U	78 U
Naphthalene	UG/KG	17000	38%	13000	1	3	8	19000 U	77 J	370 U	29 J	17000 J	78 U
Nitrobenzene	UG/KG	0	0%	200	0	0	8	19000 U	500 U	370 U	390 U	760 U	78 U
Pentachlorophenol	UG/KG	0	0%	1000	0	0	8	45000 U	1200 U	900 U	940 U	1800 U	190 U
Phenanthrene	UG/KG	66000	75%	50000	1	6	8	66000	1900	770	260 J	3800	78 U
Phenol	UG/KG	0	0%	30	0	0	8	19000 U	500 U	370 U	390 U	760 U	78 U
Pyrene	UG/KG	63000	88%	50000	1	7	8	63000	1600	2000	390	1700	78 U
Pyridine	UG/KG	0	88%		0	0	0						
Pesticides/PCBs													
4,4'-DDD	UG/KG	0	0%	2900	0	0	8	37 U	3.7 U	3.7 U	3.9 U	3.8 U	3.9 U
4,4'-DDE	UG/KG	4.2	25%	2100	0	2	8	37 U	3.7 U	3.1 J	4.2 J	3.8 U	3.9 U
4,4'-DDT	UG/KG	13	38%	2100	0	3	8	37 U	3.7 U	8.4	13	5.1 J	3.9 U
Aldrin	UG/KG	0	0%	41	0	0	8	19 U	1.9 U	1.9 U	2 U	2 U	2 U
Alpha-BHC	UG/KG	18	38%	110	0	3	8	19 U	1.9 U	1.9 U	2 U	2 U	2.9
Alpha-Chlordane	UG/KG	74	13%		0	1	8	74 J	1.9 U	1.9 U	2 U	2 U	2 U
Beta-BHC	UG/KG	2.7	25%	200	0	2	8	19 U	1.9 U	1.9 U	2 U	2 U	2 U
Delta-BHC	UG/KG	1.8	13%	300	0	1	8	19 U	1.9 U	1.9 U	2 U	2 U	2 U
Dieldrin	UG/KG	3.5	13%	44	0	1	8	37 U	3.5 J	3.7 U	3.9 U	3.8 U	3.9 U
Endosulfan I	UG/KG	200	50%	900	0	4	8	200 J	3.5	6.6 J	2.8 J	2 U	2 U
Endosulfan II	UG/KG	26	25%	900	0	2	8	26 J	2.5 J	3.7 U	3.9 U	3.8 U	3.9 U
Endosulfan sulfate	UG/KG	0	0%	1000	0	0	8	37 U	3.7 U	3.7 U	3.9 U	3.8 U	3.9 U
Endrin	UG/KG	29	25%	100	0	2	8	29 J	3.7 U	3.7 U	3.9 U	3.7 J	3.9 U
Endrin aldehyde	UG/KG	7.2	25%		0	2	8	37 U	3.7 U	3.7 U	3.9 U	7.2 J	3.9 U
Endrin ketone	UG/KG	2.2	13%		0	1	8	37 U	3.7 U	3.7 U	3.9 U	2.2 J	3.9 U
Gamma-BHC/Lindane	UG/KG	4	13%	60	0	1	8	19 U	1.9 U	1.9 U	2 U	2 U	2 U
Gamma-Chlordane	UG/KG	1.1	13%	540	0	1	8	19 U	1.9 U	1.9 U	2 U	1.1 J	2 U
Heptachlor	UG/KG	1.2	13%	100	0	1	8	19 U	1.2 J	1.9 U	2 U	2 U	2 U
Heptachlor epoxide	UG/KG	1.5	13%	20	0	1	8	19 U	1.9 U	1.9 U	2 U	1.5 J	2 U
Methoxychlor	UG/KG	19	13%		0	1	8	190 U	19 U	19 U	20 U	19 J	20 U
Toxaphene	UG/KG	0	0%		0	0	8	1900 U	190 U	190 U	200 U	200 U	200 U
Aroclor-1016	UG/KG	0	0%		0	0	8	370 U	37 U	37 U	39 U	38 U	39 U
Aroclor-1221	UG/KG	0	0%		0	0	8	750 U	76 U	75 U	79 U	77 U	79 U
Aroclor-1232	UG/KG	0	0%		0	0	8	370 U	37 U	37 U	39 U	38 U	39 U
Aroclor-1242	UG/KG	0	0%		0	0	8	370 U	37 U	37 U	39 U	38 U	39 U
Aroclor-1248	UG/KG	0	0%		0	0	8	370 U	37 U	37 U	39 U	38 U	39 U

Table A-4B
SUBSURFACE SOIL SAMPLE RESULTS (2-15 ft.)
SEAD-71
SEAD-59 and SEAD-71 Phase II RI Report
Seneca Army Depot Activity

Facility	SEAD-71	SEAD-71	SEAD-71	SEAD-71	SEAD-71	SEAD-71
Location ID	TP71-1	TP71-1	TP71-1	TP71-1	TP71-3-2	TP71-4-2
Maxtrix	SOIL	SOIL	SOIL	SOIL	SOIL	SOIL
Sample ID	TP71-1-1	TP71-1-2	TP71-1-3	TP71-1-4	71003	71006
Sample Depth to Top of Sample	3	3	3	4	10.5	10
Sample Depth to Bottom of Sample	3	3	3	4	11	10.5
Sample Date	6/7/1994	6/7/1994	6/7/1994	6/7/1994	10/14/1997	10/14/1997
QC Code	SA	SA	SA	SA	SA	SA
Study ID	ESI	ESI	ESI	ESI	RI PHASE 1 STEP 1	RI PHASE 1 STEP 1

Parameter	Units	Maximum Frequency of		NYSDEC TAGM 4046 ⁽²⁾	Number of Exceedances	Number of Detects	Number of Analyses	Value (Q)	Value (Q)	Value (Q)	Value (Q)	Value (Q)	Value (Q)
		Value	Detection										
Aroclor-1254	UG/KG	0	0%	10000	0	0	8	370 U	37 U	37 U	39 U	38 U	39 U
Aroclor-1260	UG/KG	0	0%	10000	0	0	8	370 U	37 U	37 U	39 U	38 U	39 U
Metals													
Aluminum	MG/KG	14500	100%	19300	0	8	8	12900	13100	10900	9960	8090 J	14500 J
Antimony	MG/KG	0.47	25%	5.9	0	2	8	0.19 J	0.27 UJ	0.23 UJ	0.47 J	0.56 UJ	0.68 UJ
Arsenic	MG/KG	5.4	100%	8.2	0	8	8	5.4	5.1	5.2	4.8	4.3	3.1
Barium	MG/KG	94.1	100%	300	0	8	8	86.2	69.2	69.8	63.5	51.3	94.1
Beryllium	MG/KG	0.58	100%	1.1	0	8	8	0.58 J	0.56 J	0.53 J	0.47 J	0.21	0.56
Cadmium	MG/KG	0.53	50%	2.3	0	4	8	0.53 J	0.39 J	0.45 J	0.45 J	0.08 U	0.09 U
Calcium	MG/KG	134000	100%	121000	1	8	8	38000 J	52800 J	32200 J	36500 J	134000	36000
Chromium	MG/KG	21.2	100%	29.6	0	8	8	18.4	17.9	16.3	15.5	12.9	21.2
Cobalt	MG/KG	11	100%	30	0	8	8	9.4	9.3 J	9.7	8.7 J	11	9
Copper	MG/KG	26.7	100%	33	0	8	8	25.4	19	23	26.7	15.2	19.1
Cyanide	MG/KG	0	0%	0.35	0	0	8	0.54 U	0.46 U	0.5 U	0.35 U	0.65 U	0.64 U
Iron	MG/KG	23600	100%	36500	0	8	8	23600	22700	21600	20000	18000	21600
Lead	MG/KG	96.9	100%	24.8	3	8	8	96.9	10.3	43.8	67.8	8.9 J	9.8 J
Magnesium	MG/KG	10100	100%	21500	0	8	8	8690	7910	8840	9180	6760 J	8120 J
Manganese	MG/KG	784	100%	1060	0	8	8	497	390	474	458	784 J	345 J
Mercury	MG/KG	0.03	50%	0.1	0	4	8	0.03 J	0.03 J	0.03 J	0.03 J	0.05 U	0.05 U
Nickel	MG/KG	28	100%	49	0	8	8	26.8	25.2	24.9	24.6	26.2	28
Potassium	MG/KG	2940	100%	2380	1	8	8	1340 J	1540 J	1230 J	1520 J	1120	2940
Selenium	MG/KG	1.2	25%	2	0	2	8	0.43 J	0.57 U	0.47 U	0.56 U	0.77 U	0.93 U
Silver	MG/KG	0	0%	0.75	0	0	8	0.07 UJ	0.11 UJ	0.09 UJ	0.1 UJ	0.21 U	0.26 U
Sodium	MG/KG	140	75%	172	0	6	8	54.9 J	108 J	140 J	90.7 J	83.3 U	109
Thallium	MG/KG	0	0%	0.7	0	0	8	0.25 U	0.4 U	0.33 U	0.4 U	1.2 U	1.4 U
Vanadium	MG/KG	24.9	100%	150	0	8	8	19.7	20.1	17.9	18.2	15.1	24.9
Zinc	MG/KG	96.2	100%	110	0	8	8	96.2	63.9	86.1	79.7	57 J	61.5 J

Note(s):

(1) - Historical sample depths are presented (I.e. prior to 2002 TCRA)

(2) - NYSDEC Technical and Administrative Guidance Memorandum (TAGM) HWR-94-4046

U = compound was not detected

J = the reported value is an estimated concentration

UJ = the compound was not detected; the associated reporting limit is approximate

R = the data was rejected in the data validating process

NJ = compound was "tentatively identified" and the associated numerical value is approximate

Table A-4B
SUBSURFACE SOIL SAMPLE RESULTS (2-15 ft.)
SEAD-71
SEAD-59 and SEAD-71 Phase II RI Report
Seneca Army Depot Activity

Facility	SEAD-71	SEAD-71
Location ID	TP71-5-1	TP71-6-1
Maxtrix	SOIL	SOIL
Sample ID	71007	71010
Sample Depth to Top of Sample	7	12.5
Sample Depth to Bottom of Sample	7.5	13
Sample Date	10/14/1997	10/15/1997
QC Code	SA	SA
Study ID	RI PHASE 1 STEP 1	RI PHASE 1 STEP 1

Parameter	Units	Maximum Frequency of		NYSDEC TAGM 4046 ⁽²⁾	Number of Exceedances	Number of Detects	Number of Analyses	Value (Q)	Value (Q)
		Value	Detection						
Volatile Organics									
1,1,1-Trichloroethane	UG/KG	23	63%	800	0	5	8	12 U	4 J
1,1,2,2-Tetrachloroethane	UG/KG	0	0%	600	0	0	8	12 U	12 U
1,1,2-Trichloro-1,2,2-Trifluoroethane	UG/KG	0	0%		0	0	0		
1,1,2-Trichloroethane	UG/KG	0	0%		0	0	8	12 U	12 U
1,1-Dichloroethane	UG/KG	0	0%	200	0	0	8	12 U	12 U
1,1-Dichloroethene	UG/KG	0	0%	400	0	0	8	12 U	12 U
1,2,3-Trichloropropane	UG/KG	0	0%		0	0	0		
1,2,4-Trichlorobenzene	UG/KG	0	0%	3400	0	0	0		
1,2-Dibromo-3-chloropropane	UG/KG	0	0%		0	0	0		
1,2-Dibromoethane	UG/KG	0	0%		0	0	0		
1,2-Dichlorobenzene	UG/KG	0	0%	7900	0	0	0		
1,2-Dichloroethane	UG/KG	0	0%	100	0	0	8	12 U	12 U
1,2-Dichloroethene (total)	UG/KG	0	0%		0	0	8	12 U	12 U
1,2-Dichloropropane	UG/KG	0	0%		0	0	8	12 U	12 U
1,3-Dichlorobenzene	UG/KG	0	0%	1600	0	0	0		
1,3-Dichloropropane	UG/KG	0	0%		0	0	0		
1,4-Dichlorobenzene	UG/KG	0	0%	8500	0	0	0		
Acetone	UG/KG	0	0%	200	0	0	8	12 U	12 U
Benzene	UG/KG	0	0%	60	0	0	8	12 U	12 U
Bromodichloromethane	UG/KG	0	0%		0	0	8	12 U	12 U
Bromoform	UG/KG	0	0%		0	0	8	12 U	12 U
Carbon disulfide	UG/KG	0	0%	2700	0	0	8	12 U	12 U
Carbon tetrachloride	UG/KG	0	0%	600	0	0	8	12 U	12 U
Chlorobenzene	UG/KG	0	0%	1700	0	0	8	12 U	12 U
Chlorodibromomethane	UG/KG	0	0%		0	0	8	12 U	12 U
Chloroethane	UG/KG	0	0%	1900	0	0	8	12 U	12 U
Chloroform	UG/KG	0	0%	300	0	0	8	12 U	12 U
Cis-1,2-Dichloroethene	UG/KG	0	0%		0	0	0		
Cis-1,3-Dichloropropene	UG/KG	0	0%		0	0	8	12 U	12 U
Cyclohexane	UG/KG	0	0%		0	0	0		
Dichlorodifluoromethane	UG/KG	0	0%		0	0	0		
Ethyl benzene	UG/KG	0	0%	5500	0	0	8	12 U	12 U
Isopropylbenzene	UG/KG	0	0%		0	0	0		
Meta/Para Xylene	UG/KG	0	0%		0	0	0		
Methyl Acetate	UG/KG	0	0%		0	0	0		
Methyl Tertbutyl Ether	UG/KG	0	0%		0	0	0		
Methyl bromide	UG/KG	0	0%		0	0	8	12 U	12 U
Methyl butyl ketone	UG/KG	0	0%		0	0	8	12 U	12 U

Table A-4B
SUBSURFACE SOIL SAMPLE RESULTS (2-15 ft.)
SEAD-71
SEAD-59 and SEAD-71 Phase II RI Report
Seneca Army Depot Activity

Facility	SEAD-71	SEAD-71
Location ID	TP71-5-1	TP71-6-1
Maxtrix	SOIL	SOIL
Sample ID	71007	71010
Sample Depth to Top of Sample	7	12.5
Sample Depth to Bottom of Sample	7.5	13
Sample Date	10/14/1997	10/15/1997
QC Code	SA	SA
Study ID	RI PHASE 1 STEP 1	RI PHASE 1 STEP 1

Parameter	Units	Maximum Frequency of		NYSDEC TAGM 4046 ⁽²⁾	Number of Exceedances	Number of Detects	Number of Analyses	Value (Q)	Value (Q)
		Value	Detection						
Methyl chloride	UG/KG	0	0%		0	0	8	12 U	12 U
Methyl cyclohexane	UG/KG	0	0%		0	0	0		
Methyl ethyl ketone	UG/KG	0	0%	300	0	0	8	12 U	12 U
Methyl isobutyl ketone	UG/KG	0	0%	1000	0	0	8	12 U	12 U
Methylene chloride	UG/KG	2	50%	100	0	4	8	12 U	12 U
Ortho Xylene	UG/KG	0	50%		0	0	0		
Styrene	UG/KG	0	0%		0	0	8	12 U	12 U
Tetrachloroethene	UG/KG	3	38%	1400	0	3	8	12 U	12 U
Toluene	UG/KG	0	0%	1500	0	0	8	12 U	12 U
Total BTEX	MG/KG	3.5	100%		0	3	3	3.05	3.3
Total Xylenes	UG/KG	96	13%	1200	0	1	8	12 U	12 U
Trans-1,2-Dichloroethene	UG/KG	0	13%	300	0	0	0		
Trans-1,3-Dichloropropene	UG/KG	0	0%		0	0	8	12 U	12 U
Trichloroethene	UG/KG	0	0%	700	0	0	8	12 U	12 U
Trichlorofluoromethane	UG/KG	0	0%		0	0	0		
Vinyl chloride	UG/KG	0	0%	200	0	0	8	12 U	12 U
Semivolatile Organics									
1,1'-Biphenyl	UG/KG	0	0%		0	0	0		
1,2,4-Trichlorobenzene	UG/KG	0	0%	3400	0	0	8	78 U	78 U
1,2-Dichlorobenzene	UG/KG	0	0%	7900	0	0	8	78 U	78 U
1,3-Dichlorobenzene	UG/KG	0	0%	1600	0	0	8	78 U	78 U
1,4-Dichlorobenzene	UG/KG	0	0%	8500	0	0	8	78 U	78 U
2,2'-oxybis(1-Chloropropane)	UG/KG	0	0%		0	0	4		
2,4,5-Trichlorophenol	UG/KG	0	0%	100	0	0	8	190 U	190 U
2,4,6-Trichlorophenol	UG/KG	0	0%		0	0	8	78 U	78 U
2,4-Dichlorophenol	UG/KG	0	0%	400	0	0	8	78 U	78 U
2,4-Dimethylphenol	UG/KG	0	0%		0	0	8	78 U	78 U
2,4-Dinitrophenol	UG/KG	0	0%	200	0	0	8	190 U	190 U
2,4-Dinitrotoluene	UG/KG	0	0%		0	0	8	78 U	78 U
2,6-Dinitrotoluene	UG/KG	0	0%	1000	0	0	8	78 U	78 U
2-Chloronaphthalene	UG/KG	0	0%		0	0	8	78 U	78 U
2-Chlorophenol	UG/KG	0	0%	800	0	0	8	78 U	78 U
2-Methylnaphthalene	UG/KG	31000	25%	36400	0	2	8	78 U	78 U
2-Methylphenol	UG/KG	0	0%	100	0	0	8	78 U	78 U
2-Nitroaniline	UG/KG	0	0%	430	0	0	8	190 U	190 U
2-Nitrophenol	UG/KG	0	0%	330	0	0	8	78 U	78 U
3,3'-Dichlorobenzidine	UG/KG	0	0%		0	0	8	78 UJ	78 UJ
3-Nitroaniline	UG/KG	0	0%	500	0	0	8	190 UJ	190 U
4,6-Dinitro-2-methylphenol	UG/KG	0	0%		0	0	8	190 U	190 U

Table A-4B
SUBSURFACE SOIL SAMPLE RESULTS (2-15 ft.)
SEAD-71
SEAD-59 and SEAD-71 Phase II RI Report
Seneca Army Depot Activity

Facility	SEAD-71	SEAD-71
Location ID	TP71-5-1	TP71-6-1
Maxtrix	SOIL	SOIL
Sample ID	71007	71010
Sample Depth to Top of Sample	7	12.5
Sample Depth to Bottom of Sample	7.5	13
Sample Date	10/14/1997	10/15/1997
QC Code	SA	SA
Study ID	RI PHASE 1 STEP 1	RI PHASE 1 STEP 1

Parameter	Units	Maximum Frequency of		NYSDEC TAGM 4046 ⁽²⁾	Number of Exceedances	Number of Detects	Number of Analyses	Value (Q)	Value (Q)
		Value	Detection						
4-Bromophenyl phenyl ether	UG/KG	0	0%		0	0	8	78 U	78 U
4-Chloro-3-methylphenol	UG/KG	0	0%	240	0	0	8	78 U	78 U
4-Chloroaniline	UG/KG	0	0%	220	0	0	8	78 U	78 U
4-Chlorophenyl phenyl ether	UG/KG	0	0%		0	0	8	78 U	78 U
4-Methylphenol	UG/KG	0	0%	900	0	0	8	78 U	78 U
4-Nitroaniline	UG/KG	0	0%		0	0	8	190 UJ	190 UJ
4-Nitrophenol	UG/KG	0	0%	100	0	0	8	190 U	190 U
Acenaphthene	UG/KG	13000	63%	50000	0	5	8	78 U	78 U
Acenaphthylene	UG/KG	340	13%	41000	0	1	8	78 U	78 U
Acetophenone	UG/KG	0	13%		0	0	0		
Aniline	UG/KG	0	13%		0	0	0		
Anthracene	UG/KG	11000	63%	50000	0	5	8	78 U	78 U
Atrazine	UG/KG	0	63%		0	0	0		
Benzaldehyde	UG/KG	0	63%		0	0	0		
Benzo(a)anthracene	UG/KG	37000	88%	224	4	7	8	18 J	3.9 J
Benzo(a)pyrene	UG/KG	22000	88%	61	5	7	8	19 J	3.9 J
Benzo(b)fluoranthene	UG/KG	26000	88%	1100	1	7	8	21 J	4.4 J
Benzo(ghi)perylene	UG/KG	10000	75%	50000	0	6	8	12 J	78 U
Benzo(k)fluoranthene	UG/KG	15000	88%	1100	1	7	8	24 J	4.6 J
Benzoic Acid	UG/KG	0	88%	2700	0	0	0		
Bis(2-Chloroethoxy)methane	UG/KG	0	0%		0	0	8	78 U	78 U
Bis(2-Chloroethyl)ether	UG/KG	0	0%		0	0	8	78 U	78 U
Bis(2-Chloroisopropyl)ether	UG/KG	0	0%		0	0	4	78 U	78 U
Bis(2-Ethylhexyl)phthalate	UG/KG	15	38%	50000	0	3	8	15 J	7.6 J
Butylbenzylphthalate	UG/KG	0	0%	50000	0	0	8	78 U	78 U
Caprolactam	UG/KG	0	0%		0	0	0		
Carbazole	UG/KG	9500	75%		0	6	8	4.2 J	78 U
Chrysene	UG/KG	36000	88%	400	3	7	8	28 J	4.6 J
Di-n-butylphthalate	UG/KG	0	0%	8100	0	0	8	78 U	78 U
Di-n-octylphthalate	UG/KG	0	0%	50000	0	0	8	78 U	78 U
Dibenz(a,h)anthracene	UG/KG	9800	63%	14	4	5	8	4.4 J	78 U
Dibenzofuran	UG/KG	11000	25%	6200	1	2	8	78 U	78 U
Diethyl phthalate	UG/KG	0	0%	7100	0	0	8	78 U	78 U
Dimethylphthalate	UG/KG	0	0%	2000	0	0	8	78 U	78 U
Fluoranthene	UG/KG	88000	88%	50000	1	7	8	52 J	6.9 J
Fluorene	UG/KG	4100	50%	50000	0	4	8	78 U	78 U
Hexachlorobenzene	UG/KG	0	0%	410	0	0	8	78 U	78 U
Hexachlorobutadiene	UG/KG	0	0%		0	0	8	78 U	78 U
Hexachlorocyclopentadiene	UG/KG	0	0%		0	0	8	78 U	78 U

Table A-4B
SUBSURFACE SOIL SAMPLE RESULTS (2-15 ft.)
SEAD-71
SEAD-59 and SEAD-71 Phase II RI Report
Seneca Army Depot Activity

Facility	SEAD-71	SEAD-71
Location ID	TP71-5-1	TP71-6-1
Maxtrix	SOIL	SOIL
Sample ID	71007	71010
Sample Depth to Top of Sample	7	12.5
Sample Depth to Bottom of Sample	7.5	13
Sample Date	10/14/1997	10/15/1997
QC Code	SA	SA
Study ID	RI PHASE 1 STEP 1	RI PHASE 1 STEP 1

Parameter	Units	Maximum Frequency of		NYSDEC TAGM 4046 ⁽²⁾	Number of Exceedances	Number of Detects	Number of Analyses	Value (Q)	Value (Q)
		Value	Detection						
Hexachloroethane	UG/KG	0	0%		0	0	8	78 U	78 U
Indeno(1,2,3-cd)pyrene	UG/KG	12000	75%	3200	1	6	8	12 J	78 U
Isophorone	UG/KG	0	0%	4400	0	0	8	78 U	78 U
N-Nitrosodiphenylamine	UG/KG	0	0%		0	0	8	78 U	78 U
N-Nitrosodipropylamine	UG/KG	0	0%		0	0	8	78 U	78 U
Naphthalene	UG/KG	17000	38%	13000	1	3	8	78 U	78 U
Nitrobenzene	UG/KG	0	0%	200	0	0	8	78 U	78 U
Pentachlorophenol	UG/KG	0	0%	1000	0	0	8	190 U	190 U
Phenanthrene	UG/KG	66000	75%	50000	1	6	8	24 J	78 U
Phenol	UG/KG	0	0%	30	0	0	8	78 U	78 U
Pyrene	UG/KG	63000	88%	50000	1	7	8	44 J	6 J
Pyridine	UG/KG	0	88%		0	0	0		
Pesticides/PCBs									
4,4'-DDD	UG/KG	0	0%	2900	0	0	8	3.9 U	3.9 U
4,4'-DDE	UG/KG	4.2	25%	2100	0	2	8	3.9 U	3.9 U
4,4'-DDT	UG/KG	13	38%	2100	0	3	8	3.9 U	3.9 U
Aldrin	UG/KG	0	0%	41	0	0	8	2 U	2 U
Alpha-BHC	UG/KG	18	38%	110	0	3	8	4.9	18
Alpha-Chlordane	UG/KG	74	13%		0	1	8	2 U	2 U
Beta-BHC	UG/KG	2.7	25%	200	0	2	8	2 J	2.7
Delta-BHC	UG/KG	1.8	13%	300	0	1	8	2 U	1.8 J
Dieldrin	UG/KG	3.5	13%	44	0	1	8	3.9 U	3.9 U
Endosulfan I	UG/KG	200	50%	900	0	4	8	2 U	2 U
Endosulfan II	UG/KG	26	25%	900	0	2	8	3.9 U	3.9 U
Endosulfan sulfate	UG/KG	0	0%	1000	0	0	8	3.9 U	3.9 U
Endrin	UG/KG	29	25%	100	0	2	8	3.9 U	3.9 U
Endrin aldehyde	UG/KG	7.2	25%		0	2	8	3 J	3.9 U
Endrin ketone	UG/KG	2.2	13%		0	1	8	3.9 U	3.9 U
Gamma-BHC/Lindane	UG/KG	4	13%	60	0	1	8	2 U	4
Gamma-Chlordane	UG/KG	1.1	13%	540	0	1	8	2 U	2 U
Heptachlor	UG/KG	1.2	13%	100	0	1	8	2 U	2 U
Heptachlor epoxide	UG/KG	1.5	13%	20	0	1	8	2 U	2 U
Methoxychlor	UG/KG	19	13%		0	1	8	20 U	20 U
Toxaphene	UG/KG	0	0%		0	0	8	200 U	200 U
Aroclor-1016	UG/KG	0	0%		0	0	8	39 U	39 U
Aroclor-1221	UG/KG	0	0%		0	0	8	80 U	79 U
Aroclor-1232	UG/KG	0	0%		0	0	8	39 U	39 U
Aroclor-1242	UG/KG	0	0%		0	0	8	39 U	39 U
Aroclor-1248	UG/KG	0	0%		0	0	8	39 U	39 U

Table A-4B
SUBSURFACE SOIL SAMPLE RESULTS (2-15 ft.)
SEAD-71
SEAD-59 and SEAD-71 Phase II RI Report
Seneca Army Depot Activity

Facility	SEAD-71	SEAD-71
Location ID	TP71-5-1	TP71-6-1
Maxtrix	SOIL	SOIL
Sample ID	71007	71010
Sample Depth to Top of Sample	7	12.5
Sample Depth to Bottom of Sample	7.5	13
Sample Date	10/14/1997	10/15/1997
QC Code	SA	SA
Study ID	RI PHASE 1 STEP 1	RI PHASE 1 STEP 1

Parameter	Units	Maximum Frequency of		NYSDEC TAGM 4046 ⁽²⁾	Number of Exceedances	Number of Detects	Number of Analyses	Value (Q)	Value (Q)
		Value	Detection						
Aroclor-1254	UG/KG	0	0%	10000	0	0	8	39 U	39 U
Aroclor-1260	UG/KG	0	0%	10000	0	0	8	39 U	39 U
Metals									
Aluminum	MG/KG	14500	100%	19300	0	8	8	12400	9400
Antimony	MG/KG	0.47	25%	5.9	0	2	8	0.65 UJ	0.64 UJ
Arsenic	MG/KG	5.4	100%	8.2	0	8	8	5.3	4.1
Barium	MG/KG	94.1	100%	300	0	8	8	78.1	48.8
Beryllium	MG/KG	0.58	100%	1.1	0	8	8	0.31	0.31
Cadmium	MG/KG	0.53	50%	2.3	0	4	8	0.09 U	0.09 U
Calcium	MG/KG	134000	100%	121000	1	8	8	42800	46600
Chromium	MG/KG	21.2	100%	29.6	0	8	8	17.6	14.5
Cobalt	MG/KG	11	100%	30	0	8	8	9.4	8.6
Copper	MG/KG	26.7	100%	33	0	8	8	19.4	18.8
Cyanide	MG/KG	0	0%	0.35	0	0	8	0.6 UJ	0.59 UJ
Iron	MG/KG	23600	100%	36500	0	8	8	21500	19200
Lead	MG/KG	96.9	100%	24.8	3	8	8	16	7.3
Magnesium	MG/KG	10100	100%	21500	0	8	8	10100	10100
Manganese	MG/KG	784	100%	1060	0	8	8	623	345
Mercury	MG/KG	0.03	50%	0.1	0	4	8	0.05 U	0.05 U
Nickel	MG/KG	28	100%	49	0	8	8	24.1	23.3
Potassium	MG/KG	2940	100%	2380	1	8	8	1950	1340
Selenium	MG/KG	1.2	25%	2	0	2	8	1.2	0.88 U
Silver	MG/KG	0	0%	0.75	0	0	8	0.25 U	0.24 U
Sodium	MG/KG	140	75%	172	0	6	8	108 U	138
Thallium	MG/KG	0	0%	0.7	0	0	8	0.92 UJ	0.91 UJ
Vanadium	MG/KG	24.9	100%	150	0	8	8	20.2	14.8
Zinc	MG/KG	96.2	100%	110	0	8	8	82.1	73.4

Note(s):

(1) - Historical sample depths are presented (I.e. prior to 2002 TCRA)

(2) - NYSDEC Technical and Administrative Guidance Memorandum (TAGM) HWR-94-4046

U = compound was not detected

J = the reported value is an estimated concentration

UJ = the compound was not detected; the associated reporting limit is approximate

R = the data was rejected in the data validating process

NJ = compound was "tentatively identified" and the associated numerical value is approximate

**Table A-5
GROUNDWATER SAMPLE RESULTS
SEAD-71
SEAD-59 and SEAD-71 Phase II RI Report
Seneca Army Depot Activity**

Facility Location ID	SEAD-71 MW71-1	SEAD-71 MW71-3	SEAD-71 MW71-4	SEAD-71 MW71-2	SEAD-71 MW71-4	SEAD-71 MW71-1	SEAD-71 MW71-1	SEAD-71 MW71-3													
Maxtrix Sample ID	GROUNDWATER 712000	GROUNDWATER 712001	GROUNDWATER 712003	GROUNDWATER 712004	GROUNDWATER 712006	GROUNDWATER 712007	GROUNDWATER MW71-1	GROUNDWATER MW71-3													
Sample Depth to Top of Sample	8.4	7.51	20.67	0	0	0	4.3	3.5													
Sample Depth to Bottom of Sample	8.4	7.51	20.67	0	0	0	8.3	5.5													
Sample Date	4/6/2004	4/6/2004	4/5/2004	8/31/2004	8/31/2004	9/1/2004	3/29/1994	7/7/1994													
QC Code	SA	SA	SA / DU	SA	SA	SA	SA	SA													
Study ID	RI 2004	RI 2004	RI 2004	RI 2004	RI 2004	RI 2004	ESI	ESI													
Criteria	Criteria	Value (Q)		Value (Q)		Value (Q)		Value (Q)													
Units	Type ¹	Level	Value	(Q)	Value	(Q)	Value	(Q)	Value	(Q)											
Volatile Organic Compounds																					
1,1,1,2-Tetrachloroethane	UG/L	GA	5	0.25	U	0.25	U	0.25	U	0.25	U	0.25	U	0.25	U	0.25	U	0.25	U	0.25	U
1,1,1-Trichloroethane	UG/L	GA	5	0.25	U	0.25	U	3.1	0.25	U	2.5	0.25	U	0.25	U	0.25	U	5	U	5	U
1,1,2,2-Tetrachloroethane	UG/L	GA	5	0.25	U	0.25	U	0.25	U	0.25	U	0.25	U	0.25	U	0.25	U	5	U	5	U
1,1,2-Trichloroethane	UG/L	GA	1	0.25	U	0.25	U	0.25	U	0.25	U	0.25	U	0.25	U	0.25	U	5	U	5	U
1,1-Dichloroethane	UG/L	GA	5	0.25	U	0.25	U	0.25	U	0.25	U	0.25	U	0.25	U	0.25	U	5	U	5	U
1,1-Dichloroethene	UG/L	GA	5	0.25	U	0.25	U	0.25	U	0.25	U	0.25	U	0.25	U	0.25	U	5	U	5	U
1,1-Dichloropropene	UG/L	GA	5	0.25	U	0.25	U	0.25	U	0.25	U	0.25	U	0.25	U	0.25	U	0.25	U	0.25	U
1,2,3-Trichlorobenzene	UG/L	GA	5	0.25	U	0.25	U	0.25	U	0.25	U	0.25	U	0.25	U	0.25	U	0.25	U	0.25	U
1,2,3-Trichloropropane	UG/L	GA	0.04	0.25	U	0.25	U	0.25	U	0.25	U	0.25	U	0.25	U	0.25	U	0.25	U	0.25	U
1,2,4-Trichlorobenzene	UG/L	GA	5	0.25	U	0.25	U	0.25	U	0.25	U	0.25	U	0.25	U	0.25	U	0.25	U	0.25	U
1,2,4-Trimethylbenzene	UG/L	GA	5	0.25	U	0.25	U	0.25	U	0.25	U	0.25	U	0.25	U	0.25	U	0.25	U	0.25	U
1,2-Dibromo-3-chloropropane	UG/L	GA	0.04	0.25	U	0.25	U	0.25	U	0.25	U	0.25	U	0.25	U	0.25	U	0.25	U	0.25	U
1,2-Dibromoethane	UG/L	GA	0.0006	0.25	U	0.25	U	0.25	U	0.25	U	0.25	U	0.25	U	0.25	U	0.25	U	0.25	U
1,2-Dichlorobenzene	UG/L	GA	3	0.25	U	0.25	U	0.25	U	0.25	U	0.25	U	0.25	U	0.25	U	0.25	U	0.25	U
1,2-Dichloroethane	UG/L	GA	0.6	0.25	U	0.25	U	0.25	U	0.25	U	0.25	U	0.25	U	0.25	U	5	U	5	U
1,2-Dichloroethene (total)	UG/L	GA	5	0.25	U	0.25	U	0.25	U	0.25	U	0.25	U	0.25	U	0.25	U	5	U	5	U
1,2-Dichloropropane	UG/L	GA	1	0.25	U	0.25	U	0.25	U	0.25	U	0.25	U	0.25	U	0.25	U	5	U	5	U
1,3,5-Trimethylbenzene	UG/L	GA	5	0.25	U	0.25	U	0.25	U	0.25	U	0.25	U	0.25	U	0.25	U	0.25	U	0.25	U
1,3-Dichlorobenzene	UG/L	GA	3	0.25	U	0.25	U	0.25	U	0.25	U	0.25	U	0.25	U	0.25	U	0.25	U	0.25	U
1,3-Dichloropropane	UG/L	GA	5	0.25	U	0.25	U	0.25	U	0.25	U	0.25	U	0.25	U	0.25	U	0.25	U	0.25	U
1,4-Dichlorobenzene	UG/L	GA	3	0.25	U	0.25	U	0.25	U	0.25	U	0.25	U	0.25	U	0.25	U	0.25	U	0.25	U
2,2-Dichloropropane	UG/L	GA	3	0.25	U	0.25	U	0.25	U	0.25	U	0.25	U	0.25	U	0.25	U	0.25	U	0.25	U
2-Chlorotoluene	UG/L	GA	5	0.25	U	0.25	U	0.25	U	0.25	U	0.25	U	0.25	U	0.25	U	0.25	U	0.25	U
Acetone	UG/L	GA	5	0.25	U	0.25	U	0.25	U	0.25	U	0.25	U	0.25	U	0.25	U	5	U	5	U
Benzene	UG/L	GA	1	0.25	U	0.25	U	0.25	U	0.25	U	0.25	U	0.25	U	0.25	U	5	U	5	U
Bromobenzene	UG/L	GA	5	0.25	U	0.25	U	0.25	U	0.25	U	0.25	U	0.25	U	0.25	U	0.25	U	0.25	U
Bromochloromethane	UG/L	GA	5	0.25	U	0.25	U	0.25	U	0.25	U	0.25	U	0.25	U	0.25	U	0.25	U	0.25	U
Bromodichloromethane	UG/L	MCL	80	0.25	U	0.25	U	0.25	U	0.25	U	0.25	U	0.25	U	0.25	U	5	U	5	U
Bromoform	UG/L	MCL	80	0.25	U	0.25	U	0.25	U	0.25	U	0.25	U	0.25	U	0.25	U	5	U	5	U
Carbon disulfide	UG/L	GA	5	0.25	U	0.25	U	0.25	U	0.25	U	0.25	U	0.25	U	0.25	U	5	U	5	U
Carbon tetrachloride	UG/L	GA	5	0.25	U	0.25	U	0.25	U	0.25	U	0.25	U	0.25	U	0.25	U	5	U	5	U
Chlorobenzene	UG/L	GA	5	0.25	U	0.25	U	0.25	U	0.25	U	0.25	U	0.25	U	0.25	U	5	U	5	U
Chlorodibromomethane	UG/L	MCL	80	0.25	U	0.25	U	0.25	U	0.25	U	0.25	U	0.25	U	0.25	U	5	U	5	U
Chloroethane	UG/L	GA	5	0.25	U	0.25	U	0.25	U	0.25	U	0.25	U	0.25	U	0.25	U	5	U	5	U
Chloroform	UG/L	GA	7	0.25	U	0.25	U	0.25	U	0.25	U	0.25	U	0.25	U	0.25	U	5	U	5	U
Cis-1,2-Dichloroethene	UG/L	GA	5	0.25	U	0.25	U	0.25	U	0.25	U	0.25	U	0.25	U	0.25	U	0.25	U	0.25	U
Cis-1,3-Dichloropropene	UG/L	GA	0.4	0.25	U	0.25	U	0.25	U	0.25	U	0.25	U	0.25	U	0.25	U	5	U	5	U
Dichlorodifluoromethane	UG/L	GA	5	0.25	U	0.25	U	0.25	U	0.25	U	0.25	U	0.25	U	0.25	U	0.25	U	0.25	U
Ethyl benzene	UG/L	GA	5	0.25	U	0.25	U	0.25	U	0.25	U	0.25	U	0.25	U	0.25	U	5	U	5	U

**Table A-5
GROUNDWATER SAMPLE RESULTS
SEAD-71
SEAD-59 and SEAD-71 Phase II RI Report
Seneca Army Depot Activity**

Facility Location ID	SEAD-71 MW71-1	SEAD-71 MW71-3	SEAD-71 MW71-4	SEAD-71 MW71-2	SEAD-71 MW71-4	SEAD-71 MW71-1	SEAD-71 MW71-1	SEAD-71 MW71-3						
Maxtrix Sample ID	GROUNDWATER 712000	GROUNDWATER 712001	GROUNDWATER 712003	GROUNDWATER 712004	GROUNDWATER 712006	GROUNDWATER 712007	GROUNDWATER MW71-1	GROUNDWATER MW71-3						
Sample Depth to Top of Sample	8.4	7.51	20.67	0	0	0	4.3	3.5						
Sample Depth to Bottom of Sample	8.4	7.51	20.67	0	0	0	8.3	5.5						
Sample Date	4/6/2004	4/6/2004	4/5/2004	8/31/2004	8/31/2004	9/1/2004	3/29/1994	7/7/1994						
QC Code	SA	SA	SA / DU	SA	SA	SA	SA	SA						
Study ID	RI 2004	RI 2004	RI 2004	RI 2004	RI 2004	RI 2004	RI 2004	ESI						
Criteria	Criteria	Criteria	Criteria	Criteria	Criteria	Criteria	Criteria	Criteria						
Units	Type ¹	Level	Value	(Q)	Value	(Q)	Value	(Q)	Value	(Q)	Value	(Q)	Value	(Q)
Hexachlorobutadiene	UG/L	GA	0.5	0.25 U	0.25 U	0.25 U	0.25 U	0.25 U	0.25 U	0.25 U	0.25 U	0.25 U	0.25 U	0.25 U
Isopropylbenzene	UG/L	GA	5	0.25 U	0.25 U	0.25 U	0.25 U	0.25 U	0.25 U	0.25 U	0.25 U	0.25 U	0.25 U	0.25 U
Meta/Para Xylene	UG/L			0.25 U	0.25 U	0.25 U	0.25 U	0.25 U	0.25 U	0.25 U	0.25 U	0.25 U	0.25 U	0.25 U
Methyl bromide	UG/L	GA	5	0.25 U	0.25 U	0.25 U	0.25 U	0.25 U	0.25 U	0.25 U	0.25 U	5 U	5 U	5 U
Methyl butyl ketone	UG/L											5 U	5 U	5 U
Methyl chloride	UG/L	GA	5	0.25 U	0.25 U	0.25 U	0.25 U	0.25 U	0.25 U	0.25 U	0.25 U	5 U	5 U	5 U
Methyl ethyl ketone	UG/L											5 U	5 U	5 U
Methyl isobutyl ketone	UG/L											5 U	5 U	5 U
Methylene bromide	UG/L	GA	5	0.25 U	0.25 U	0.25 U	0.25 U	0.25 U	0.25 U	0.25 U	0.25 U	0.25 U	0.25 U	0.25 U
Methylene chloride	UG/L	GA	5	0.25 U	0.25 U	0.25 U	0.25 U	0.25 U	0.25 U	0.25 U	0.25 U	5 U	5 U	5 U
Naphthalene	UG/L			0.25 U	0.25 U	0.25 U	0.25 U	0.25 U	0.25 U	0.25 U	0.25 U	0.25 U	0.25 U	0.25 U
Ortho Xylene	UG/L	GA	5	0.25 U	0.25 U	0.25 U	0.25 U	0.25 U	0.25 U	0.25 U	0.25 U	0.25 U	0.25 U	0.25 U
Propylbenzene	UG/L	GA	5	0.25 U	0.25 U	0.25 U	0.25 U	0.25 U	0.25 U	0.25 U	0.25 U	0.25 U	0.25 U	0.25 U
Styrene	UG/L	GA	5	0.25 U	0.25 U	0.25 U	0.25 U	0.25 U	0.25 U	0.25 U	0.25 U	5 U	5 U	5 U
Tetrachloroethene	UG/L	GA	5	0.25 U	0.25 U	0.25 U	0.25 U	0.25 U	0.25 U	0.25 U	0.25 U	5 U	5 U	5 U
Toluene	UG/L	GA	5	0.25 U	0.25 U	0.25 U	0.25 U	0.25 U	0.25 U	0.25 U	0.25 U	5 U	5 U	5 U
Total Xylenes	UG/L	GA	5	0.25 U	0.25 U	0.25 U	0.25 U	0.25 U	0.25 U	0.25 U	0.25 U	5 U	5 U	5 U
Trans-1,2-Dichloroethene	UG/L	GA	5	0.25 U	0.25 U	0.25 U	0.25 U	0.25 U	0.25 U	0.25 U	0.25 U	0.25 U	0.25 U	0.25 U
Trans-1,3-Dichloropropene	UG/L	GA	0.4	0.25 U	0.25 U	0.25 U	0.25 U	0.25 U	0.25 U	0.25 U	0.25 U	5 U	5 U	5 U
Trichloroethene	UG/L	GA	5	0.25 U	0.25 U	0.25 U	0.25 U	0.25 U	0.25 U	0.25 U	0.25 U	5 U	5 U	5 U
Trichlorofluoromethane	UG/L	GA	5	0.25 U	0.25 U	0.25 U	0.25 U	0.25 U	0.25 U	0.25 U	0.25 U	0.25 U	0.25 U	0.25 U
Vinyl acetate	UG/L			0.5 U	0.5 U	0.5 U	0.5 U	0.5 U	0.5 U	0.5 U	0.5 U	0.5 U	0.5 U	0.5 U
Vinyl chloride	UG/L	GA	2	0.25 U	0.25 U	0.25 U	0.25 U	0.25 U	0.25 U	0.25 U	0.25 U	5 U	5 U	5 U
n-Butylbenzene	UG/L	GA	5	0.25 U	0.25 U	0.25 U	0.25 U	0.25 U	0.25 U	0.25 U	0.25 U	0.25 U	0.25 U	0.25 U
p-Chlorotoluene	UG/L	GA	5	0.25 U	0.25 U	0.25 U	0.25 U	0.25 U	0.25 U	0.25 U	0.25 U	0.25 U	0.25 U	0.25 U
p-Isopropyltoluene	UG/L	GA	5	0.25 U	0.25 U	0.25 U	0.25 U	0.25 U	0.25 U	0.25 U	0.25 U	0.25 U	0.25 U	0.25 U
sec-Butylbenzene	UG/L	GA	5	0.25 U	0.25 U	0.25 U	0.25 U	0.25 U	0.25 U	0.25 U	0.25 U	0.25 U	0.25 U	0.25 U
tert-Butylbenzene	UG/L	GA	5	0.25 U	0.25 U	0.25 U	0.25 U	0.25 U	0.25 U	0.25 U	0.25 U	0.25 U	0.25 U	0.25 U
SVOCs														
1,2,4-Trichlorobenzene	UG/L	GA	5	4.85 U	5.05 U	4.9 U	5.55 U	4.8 U	5.45 U	5.45 U	5.45 U	5 U	6.5 U	6.5 U
1,2-Dichlorobenzene	UG/L	GA	3	4.85 U	5.05 U	4.9 U	5.55 U	4.8 U	5.45 U	5.45 U	5.45 U	5 U	6.5 U	6.5 U
1,2-Diphenylhydrazine	UG/L	GA	0	4.85 U	5.05 U	4.9 U	5.55 U	4.8 U	5.45 U	5.45 U	5.45 U	5 U	6.5 U	6.5 U
1,3-Dichlorobenzene	UG/L	GA	3	4.85 U	5.05 U	4.9 U	5.55 U	4.8 U	5.45 U	5.45 U	5.45 U	5 U	6.5 U	6.5 U
1,4-Dichlorobenzene	UG/L	GA	3	4.85 U	5.05 U	4.9 U	5.55 U	4.8 U	5.45 U	5.45 U	5.45 U	5 U	6.5 U	6.5 U
2,2'-oxybis(1-Chloropropane)	UG/L											5 U	6.5 U	6.5 U
2,4,5-Trichlorophenol	UG/L	GA	1	4.85 U	5.05 U	4.9 U	5.55 U	4.8 U	5.45 U	5.45 U	5.45 U	13 U	16 U	16 U
2,4,6-Trichlorophenol	UG/L	GA	1	4.85 U	5.05 U	4.9 U	5.55 U	4.8 U	5.45 U	5.45 U	5.45 U	5 U	6.5 U	6.5 U
2,4-Dichlorophenol	UG/L	GA	5	4.85 U	5.05 U	4.9 U	5.55 U	4.8 U	5.45 U	5.45 U	5.45 U	5 U	6.5 U	6.5 U
2,4-Dimethylphenol	UG/L			4.85 U	5.05 U	4.9 U	5.55 U	4.8 U	5.45 U	5.45 U	5.45 U	5 U	6.5 U	6.5 U
2,4-Dinitrophenol	UG/L			9.7 U	10.1 U	9.8 U	11.1 U	9.6 U	10.85 U	10.85 U	10.85 U	13 U	16 U	16 U

**Table A-5
GROUNDWATER SAMPLE RESULTS
SEAD-71
SEAD-59 and SEAD-71 Phase II RI Report
Seneca Army Depot Activity**

Facility Location ID	SEAD-71 MW71-1	SEAD-71 MW71-3	SEAD-71 MW71-4	SEAD-71 MW71-2	SEAD-71 MW71-4	SEAD-71 MW71-1	SEAD-71 MW71-1	SEAD-71 MW71-3			
Maxtrix Sample ID	GROUNDWATER 712000	GROUNDWATER 712001	GROUNDWATER 712003	GROUNDWATER 712004	GROUNDWATER 712006	GROUNDWATER 712007	GROUNDWATER MW71-1	GROUNDWATER MW71-3			
Sample Depth to Top of Sample	8.4	7.51	20.67	0	0	0	4.3	3.5			
Sample Depth to Bottom of Sample	8.4	7.51	20.67	0	0	0	8.3	5.5			
Sample Date	4/6/2004	4/6/2004	4/5/2004	8/31/2004	8/31/2004	9/1/2004	3/29/1994	7/7/1994			
QC Code	SA	SA	SA / DU	SA	SA	SA	SA	SA			
Study ID	RI 2004	RI 2004	RI 2004	RI 2004	RI 2004	RI 2004	ESI	ESI			
Criteria	Criteria	Criteria	Criteria	Criteria	Criteria	Criteria	Criteria	Criteria			
Units	Type ¹	Level	Value (Q)	Value (Q)	Value (Q)	Value (Q)	Value (Q)	Value (Q)			
2,4-Dinitrotoluene	UG/L	GA	5	4.85 U	5.05 U	4.9 U	5.55 U	4.8 U	5.45 U	5 U	6.5 U
2,6-Dichlorophenol	UG/L			4.85 U	5.05 U	4.9 U	5.55 U	4.8 U	5.45 U		
2,6-Dinitrotoluene	UG/L	GA	5	4.85 U	5.05 U	4.9 U	5.55 U	4.8 U	5.45 U	5 U	6.5 U
2-Chloronaphthalene	UG/L			0.485 U	0.5 U	0.49 U	0.55 U	0.48 U	0.55 U	5 U	6.5 U
2-Chlorophenol	UG/L			4.85 U	5.05 U	4.9 U	5.55 U	4.8 U	5.45 U	5 U	6.5 U
2-Methylnaphthalene	UG/L			0.485 U	0.5 U	0.49 U	0.55 U	0.48 U	0.55 U	5 U	6.5 U
2-Methylphenol	UG/L			4.85 U	5.05 U	4.9 U	5.55 U	4.8 U	5.45 U	5 U	6.5 U
2-Nitroaniline	UG/L	GA	5	4.85 U	5.05 U	4.9 U	5.55 U	4.8 U	5.45 U	13 U	16 U
2-Nitrophenol	UG/L	GA	1	4.85 U	5.05 U	4.9 U	5.55 U	4.8 U	5.45 U	5 U	6.5 U
3,3'-Dichlorobenzidine	UG/L	GA	5	4.85 U	5.05 U	4.9 U	5.55 U	4.8 U	5.45 U	5 U	6.5 U
3-Nitroaniline	UG/L	GA	5	4.85 U	5.05 U	4.9 U	5.55 U	4.8 U	5.45 U	13 U	16 U
4,6-Dinitro-2-methylphenol	UG/L	GA	1	4.85 U	5.05 U	4.9 U	5.55 U	4.8 U	5.45 U	13 U	16 U
4-Bromophenyl phenyl ether	UG/L			4.85 U	5.05 U	4.9 U	5.55 U	4.8 U	5.45 U	5 U	6.5 U
4-Chloro-3-methylphenol	UG/L	GA	1	4.85 U	5.05 U	4.9 U	5.55 U	4.8 U	5.45 U	5 U	6.5 U
4-Chloroaniline	UG/L	GA	5	4.85 U	5.05 U	4.9 U	5.55 U	4.8 U	5.45 U	5 U	6.5 U
4-Chlorophenyl phenyl ether	UG/L			4.85 U	5.05 U	4.9 U	5.55 U	4.8 U	5.45 U	5 U	6.5 U
4-Methylphenol	UG/L			4.85 U	5.05 U	4.9 U	5.55 U	4.8 U	5.45 U	5 U	6.5 U
4-Nitroaniline	UG/L	GA	5	4.85 U	5.05 U	4.9 U	8.7 J	4.8 U	5.45 U	13 U	16 U
4-Nitrophenol	UG/L	GA	1	4.85 U	5.05 U	4.9 U	5.55 U	4.8 U	5.45 U	13 U	16 U
Acenaphthene	UG/L			0.485 U	0.5 U	0.49 U	0.55 U	0.48 U	0.55 U	5 U	6.5 U
Acenaphthylene	UG/L			0.485 U	0.5 U	0.49 U	0.55 U	0.48 U	0.55 U	5 U	6.5 U
Acetophenone	UG/L			4.85 U	5.05 U	4.9 U	5.55 U	4.8 U	5.45 U		
Anthracene	UG/L			0.485 U	0.5 U	0.49 U	0.55 U	0.48 U	0.55 U	5 U	6.5 U
Benzidine	UG/L	GA	5	24.25 U	25.25 U	24.5 U	27.8 U	24.05 U	27.15 U		
Benzo(a)anthracene	UG/L			0.485 U	0.5 U	0.49 U	0.55 U	0.48 U	0.55 U	5 U	6.5 U
Benzo(a)pyrene	UG/L	GA	0	0.485 U	0.5 U	0.49 U	0.55 U	0.48 U	0.55 U	5 U	6.5 U
Benzo(b)fluoranthene	UG/L			0.485 U	0.5 U	0.49 U	0.55 U	0.48 U	0.55 U	5 U	6.5 U
Benzo(ghi)perylene	UG/L			0.485 U	0.5 U	0.49 U	0.55 U	0.48 U	0.55 U	5 U	6.5 U
Benzo(k)fluoranthene	UG/L			0.485 U	0.5 U	0.49 U	0.55 U	0.48 U	0.55 U	5 U	6.5 U
Benzoic Acid	UG/L			9.7 UJ	10.1 UJ	9.8 U	11.1 U	9.6 U	10.85 U		
Benzyl alcohol	UG/L			4.85 U	5.05 U	4.9 U	5.55 U	4.8 U	5.45 U		
Bis(2-Chloroethoxy)methane	UG/L	GA	5	4.85 U	5.05 U	4.9 U	5.55 U	4.8 U	5.45 U	5 U	6.5 U
Bis(2-Chloroethyl)ether	UG/L	GA	1	4.85 U	5.05 U	4.9 U	5.55 U	4.8 U	5.45 U	5 U	6.5 U
Bis(2-Chloroisopropyl)ether	UG/L	GA	5	4.85 UJ	5.05 UJ	4.9 U	5.55 U	4.8 U	5.45 U		
Bis(2-Ethylhexyl)phthalate	UG/L	GA	5	4.85 U	1.6 J	4.9 U	5.55 U	4.8 U	5.45 U	6.5 U	8 U
Butylbenzylphthalate	UG/L			4.85 U	5.05 U	4.9 U	5.55 U	4.8 U	5.45 U	5 U	6.5 U
Carbazole	UG/L			4.85 U	5.05 U	4.9 U	5.55 U	4.8 U	5.45 U	5 U	6.5 U
Chrysene	UG/L			0.485 U	0.5 U	0.49 U	0.55 U	0.48 U	0.55 U	5 U	6.5 U
Di-n-butylphthalate	UG/L	GA	50	4.85 U	5.05 U	4.9 U	5.55 U	4.8 U	5.45 U	5 U	6.5 U
Di-n-octylphthalate	UG/L			4.85 U	5.05 U	4.9 U	5.55 U	4.8 U	5.45 U	5 U	6.5 U

**Table A-5
GROUNDWATER SAMPLE RESULTS
SEAD-71
SEAD-59 and SEAD-71 Phase II RI Report
Seneca Army Depot Activity**

Facility Location ID	SEAD-71 MW71-1	SEAD-71 MW71-3	SEAD-71 MW71-4	SEAD-71 MW71-2	SEAD-71 MW71-4	SEAD-71 MW71-1	SEAD-71 MW71-1	SEAD-71 MW71-3											
Maxtrix	GROUNDWATER	GROUNDWATER	GROUNDWATER	GROUNDWATER	GROUNDWATER	GROUNDWATER	GROUNDWATER	GROUNDWATER											
Sample ID	712000	712001	712003	712004	712006	712007	MW71-1	MW71-3											
Sample Depth to Top of Sample	8.4	7.51	20.67	0	0	0	4.3	3.5											
Sample Depth to Bottom of Sample	8.4	7.51	20.67	0	0	0	8.3	5.5											
Sample Date	4/6/2004	4/6/2004	4/5/2004	8/31/2004	8/31/2004	9/1/2004	3/29/1994	7/7/1994											
QC Code	SA	SA	SA / DU	SA	SA	SA	SA	SA											
Study ID	RI 2004	RI 2004	RI 2004	RI 2004	RI 2004	RI 2004	ESI	ESI											
Criteria	Criteria																		
Units	Type ¹	Level	Value	(Q)	Value	(Q)	Value	(Q)	Value	(Q)	Value	(Q)	Value	(Q)					
Dibenz(a,h)anthracene	UG/L		0.485	U	0.5	U	0.49	U	0.55	U	0.48	U	0.55	U	5	U	6.5	U	
Dibenzofuran	UG/L		4.85	U	5.05	U	4.9	U	5.55	U	4.8	U	5.45	U	5	U	6.5	U	
Diethyl phthalate	UG/L		4.85	U	5.05	U	4.9	U	5.55	U	4.8	U	5.45	U	5	U	6.5	U	
Dimethylphthalate	UG/L		4.85	U	5.05	U	4.9	U	5.55	U	4.8	U	5.45	U	5	U	6.5	U	
Diphenylamine	UG/L	GA	5	4.85	U	5.05	U	4.9	U	5.55	U	4.8	U	5.45	U				
Fluoranthene	UG/L		0.485	U	0.5	U	0.49	U	0.55	U	0.48	U	0.55	U	5	U	6.5	U	
Fluorene	UG/L		0.485	U	0.5	U	0.49	U	0.55	U	0.48	U	0.55	U	5	U	6.5	U	
Hexachlorobenzene	UG/L	GA	0.04	4.85	U	5.05	U	4.9	U	5.55	U	4.8	U	5.45	U	5	U	6.5	U
Hexachlorobutadiene	UG/L	GA	0.5	4.85	U	5.05	U	4.9	U	5.55	U	4.8	U	5.45	U	5	U	6.5	U
Hexachlorocyclopentadiene	UG/L	GA	5											5	U	6.5	U		
Hexachloroethane	UG/L	GA	5	4.85	U	5.05	U	4.9	U	5.55	U	4.8	U	5.45	U	5	U	6.5	U
Indeno(1,2,3-cd)pyrene	UG/L		0.485	UJ	0.5	UJ	0.49	U	0.55	U	0.48	U	0.55	U	5	U	6.5	U	
Isophorone	UG/L		4.85	U	5.05	U	4.9	U	5.55	U	4.8	U	5.45	U	5	U	6.5	U	
N-Nitrosodimethylamine	UG/L		4.85	UJ	5.05	UJ	4.9	U	5.55	U	4.8	U	5.45	U					
N-Nitrosodiphenylamine	UG/L													5	U	6.5	U		
N-Nitrosodipropylamine	UG/L		4.85	U	5.05	U	4.9	U	5.55	U	4.8	U	5.45	U	5	U	6.5	U	
N-Nitrosopyrrolidine	UG/L		4.85	U	5.05	U	4.9	U	5.55	U	4.8	U	5.45	U					
Naphthalene	UG/L		0.485	U	0.5	U	0.49	U	0.55	U	0.48	U	0.55	U	5	U	6.5	U	
Nitrobenzene	UG/L	GA	0.4	4.85	U	5.05	U	4.9	U	5.55	U	4.8	U	5.45	U	5	U	6.5	U
Pentachlorophenol	UG/L	GA	1	4.85	U	5.05	U	4.9	U	5.55	U	4.8	UJ	5.45	U	13	U	16	U
Phenanthrene	UG/L		0.485	U	0.5	U	0.49	U	0.55	U	0.48	U	0.55	U	5	U	6.5	U	
Phenol	UG/L	GA	1	4.85	U	5.05	U	4.9	U	5.55	U	4.8	UJ	5.45	U	5	U	6.5	U
Pyrene	UG/L		0.485	U	0.5	U	0.49	U	0.55	U	0.48	U	0.55	U	5	U	6.5	U	
Pesticides/PCBs																			
4,4'-DDD	UG/L	GA	0.3	0.02	U	0.01925	U	0.018725	UJ	0.0194	U	0.0204	U	0.0198	U	0.05	U	0.055	U
4,4'-DDE	UG/L	GA	0.2	0.02	U	0.006	J	0.012625	J	0.0194	U	0.0204	U	0.0198	U	0.05	U	0.055	U
4,4'-DDT	UG/L	GA	0.2	0.02	U	0.043		0.029625	J	0.0194	U	0.0437		0.0198	U	0.05	U	0.055	U
Aldrin	UG/L	GA	0	0.01	U	0.0096	U	0.00935	UJ	0.0097	U	0.0102	U	0.0099	U	0.026	U	0.027	U
Alpha-BHC	UG/L	GA	0.01	0.01	U	0.0096	U	0.00935	UJ	0.0097	U	0.0102	U	0.0099	U	0.026	U	0.027	U
Alpha-Chlordane	UG/L														0.026	U	0.027	U	
Beta-BHC	UG/L	GA	0.04	0.01	U	0.0096	U	0.00935	UJ	0.0097	U	0.0102	U	0.0099	U	0.026	U	0.027	U
Chlordane	UG/L			0.125	U	0.12	U	0.11675	UJ	0.1215	U	0.1275	UJ	0.124	U				
Delta-BHC	UG/L	GA	0.04	0.01	U	0.0096	U	0.00935	UJ	0.0097	U	0.0102	U	0.0099	U	0.026	U	0.027	U
Dieldrin	UG/L	GA	0.004	0.02	U	0.01925	U	0.018725	UJ	0.0194	U	0.0204	U	0.0198	U	0.05	U	0.055	U
Endosulfan I	UG/L			0.01	U	0.0096	U	0.00935	UJ	0.0097	U	0.0102	U	0.0099	U	0.026	U	0.027	U
Endosulfan II	UG/L			0.02	U	0.01925	U	0.018725	UJ	0.0194	U	0.0204	U	0.0198	U	0.05	U	0.055	U
Endosulfan sulfate	UG/L			0.02	U	0.01925	U	0.018725	UJ	0.0194	U	0.0204	U	0.0198	U	0.05	U	0.055	U
Endrin	UG/L	GA	0	0.02	U	0.01925	U	0.018725	UJ	0.0194	U	0.0204	U	0.0198	U	0.05	U	0.055	U
Endrin aldehyde	UG/L	GA	5	0.02	U	0.01925	U	0.018725	UJ	0.0194	U	0.0204	U	0.0198	U	0.05	U	0.055	U
Endrin ketone	UG/L	GA	5	0.02	U	0.008	J	0.018725	UJ	0.0194	U	0.0204	U	0.0198	U	0.05	U	0.055	U

**Table A-5
GROUNDWATER SAMPLE RESULTS
SEAD-71
SEAD-59 and SEAD-71 Phase II RI Report
Seneca Army Depot Activity**

Facility Location ID	SEAD-71 MW71-1	SEAD-71 MW71-3	SEAD-71 MW71-4	SEAD-71 MW71-2	SEAD-71 MW71-4	SEAD-71 MW71-1	SEAD-71 MW71-1	SEAD-71 MW71-3						
Matrix	GROUNDWATER	GROUNDWATER	GROUNDWATER	GROUNDWATER	GROUNDWATER	GROUNDWATER	GROUNDWATER	GROUNDWATER						
Sample ID	712000	712001	712003	712004	712006	712007	MW71-1	MW71-3						
Sample Depth to Top of Sample	8.4	7.51	20.67	0	0	0	4.3	3.5						
Sample Depth to Bottom of Sample	8.4	7.51	20.67	0	0	0	8.3	5.5						
Sample Date	4/6/2004	4/6/2004	4/5/2004	8/31/2004	8/31/2004	9/1/2004	3/29/1994	7/7/1994						
QC Code	SA	SA	SA / DU	SA	SA	SA	SA	SA						
Study ID	RI 2004	RI 2004	RI 2004	RI 2004	RI 2004	RI 2004	ESI	ESI						
Criteria	Criteria	Criteria	Criteria	Criteria	Criteria	Criteria	Criteria	Criteria						
Units	Type ¹	Level	Value	(Q)	Value	(Q)	Value	(Q)	Value	(Q)	Value	(Q)	Value	(Q)
Gamma-BHC/Lindane	UG/L	GA	0.05	0.01 U	0.0096 U	0.00935 UJ	0.0097 U	0.0102 U	0.0099 U	0.026 U	0.027 U	0.026 U	0.027 U	
Gamma-Chlordane	UG/L									0.026 U	0.027 U	0.026 U	0.027 U	
Heptachlor	UG/L	GA	0.04	0.01 UJ	0.0096 U	0.00935 UJ	0.0097 U	0.0102 U	0.0099 U	0.026 U	0.027 U	0.026 U	0.027 U	
Heptachlor epoxide	UG/L	GA	0.03	0.01 U	0.0096 U	0.00935 UJ	0.0097 U	0.0102 U	0.0099 U	0.026 U	0.027 U	0.026 U	0.027 U	
Methoxychlor	UG/L	GA	35	0.1 U	0.096 U	0.0935 UJ	0.097 U	0.102 U	0.099 U	0.26 U	0.27 U	0.26 U	0.27 U	
Toxaphene	UG/L	GA	0.06	0.5 U	0.481 U	0.46775 UJ	0.4855 U	0.51 UJ	0.495 U	2.6 U	2.7 U	2.6 U	2.7 U	
Aroclor-1016	UG/L	GA	0.09	0.25 U	0.2405 U	0.23375 UJ	0.2425 U	0.255 U	0.2475 U	0.5 U	0.55 U	0.5 U	0.55 U	
Aroclor-1221	UG/L	GA	0.09	0.25 U	0.2405 U	0.23375 UJ	0.2425 U	0.255 U	0.2475 U	1.05 U	1.1 U	1.05 U	1.1 U	
Aroclor-1232	UG/L	GA	0.09	0.25 U	0.2405 U	0.23375 UJ	0.2425 U	0.255 U	0.2475 U	0.5 U	0.55 U	0.5 U	0.55 U	
Aroclor-1242	UG/L	GA	0.09	0.25 U	0.2405 U	0.23375 UJ	0.2425 U	0.255 U	0.2475 U	0.5 U	0.55 U	0.5 U	0.55 U	
Aroclor-1248	UG/L	GA	0.09	0.25 U	0.2405 U	0.23375 UJ	0.2425 U	0.255 U	0.2475 U	0.5 U	0.55 U	0.5 U	0.55 U	
Aroclor-1254	UG/L	GA	0.09	0.25 U	0.2405 U	0.23375 UJ	0.2425 U	0.255 U	0.2475 U	0.5 U	0.55 U	0.5 U	0.55 U	
Aroclor-1260	UG/L	GA	0.09	0.25 U	0.2405 U	0.23375 UJ	0.2425 U	0.255 U	0.2475 U	0.5 U	0.55 U	0.5 U	0.55 U	
Inorganics														
Aluminum	UG/L	SEC	50	7.35 U	12200	7.35 U	50 U	146	51.2 J	19700	334	19700	334	
Antimony	UG/L	GA	3	6.52 J	2.54 U	6.28 J	5 U	5 U	5 U	0.5 U	0.65 U	0.5 U	0.65 U	
Arsenic	UG/L	MCL	10	1.12 U	1.12 U	11.2 U	2.5 U	2.5 U	2.5 U	2.7 J	1 U	2.5 U	2.7 J	
Barium	UG/L	GA	1000	37.1	47.9	62.85	121	74.3	46.9 J	164 J	37.7 J	46.9 J	37.7 J	
Beryllium	UG/L	MCL	4	0.079 U	0.819	0.079 U	2.5 U	2.5 U	2.5 U	0.88 J	0.05 U	2.5 U	0.88 J	
Cadmium	UG/L	GA	5	0.1565 U	0.1565 U	0.1565 U	2.5 U	2.5 U	2.5 U	0.33 J	0.1 U	2.5 U	0.33 J	
Calcium	UG/L			218000	97800	178000	164000	148000	210000 J	212000	146000	210000 J	212000	
Chromium	UG/L	GA	50	0.2515 U	4.58	0.2515 U	2.5 U	0.82 J	2.5 U	33.1	0.59 J	2.5 U	33.1	
Cobalt	UG/L			0.2705 U	0.631 J	0.2705 U	1.2 J	2.5 U	2.5 U	22.1 J	1.1 J	2.5 U	22.1 J	
Copper	UG/L	GA	200	0.695 U	5.3	1.425 J	2.5 U	2.5 U	2.5 U	16.1 J	0.75 J	2.5 U	16.1 J	
Cyanide	UG/L									2.5 U	2.5 U		2.5 U	
Iron	UG/L	GA	300	30.2 J	4470	22.9 J	83.7	148	39.1 J	35100	613	35100	613	
Lead	UG/L	MCL	15	0.86 U	7.3	0.86 U	2.1 J	2.5 U	2.5 U	17.2	0.445 U	2.5 U	17.2	
Magnesium	UG/L			28800	12500	21650	20500	20100	28400	32400	18000	28400	32400	
Manganese	UG/L	SEC	50	46.5	76.7	0.148 U	2680	8.1	16.1 J	1680	557	1680	557	
Mercury	UG/L	GA	0.7	0.0235 U	0.069 J	0.0235 U	0.1 U	0.1 U	0.1 U	0.06 J	0.05 J	0.1 U	0.06 J	
Nickel	UG/L	GA	100	0.345 U	4.79	0.345 U	6.6	0.74 J	1.7 J	49.4	2.6 J	1.7 J	49.4	
Potassium	UG/L			765 J	950 J	1090 J	1150	1050	842 J	3260 J	4910 J	842 J	3260 J	
Selenium	UG/L	GA	10	1.405 U	1.405 U	1.405 U	2.5 U	2.5 R	2.5 R	0.85 U	1.35 U	2.5 R	0.85 U	
Silver	UG/L	GA	50	0.4175 U	0.4175 U	0.4175 U	2.5 U	2.5 U	2.5 U	0.35 U	0.25 U	2.5 U	0.35 U	
Sodium	UG/L	GA	20000	6720	62200	42050	16000	48200	7920 J	9180	4130 J	7920 J	9180	
Thallium	UG/L	MCL	2	5 U	5 U	5 U	10 U	10 U	10 U	0.8 U	2.5 J	10 U	0.8 U	
Vanadium	UG/L			0.303 U	3 J	0.303 U	2.5 U	2.5 U	2.5 U	25.7 J	0.9 J	2.5 U	25.7 J	
Zinc	UG/L	SEC	5000	2.26 J	41.7	8.49	83.4	9.2	1.6 J	97.3	6.5 J	1.6 J	97.3	

Note(s):

**Table A-5
GROUNDWATER SAMPLE RESULTS
SEAD-71
SEAD-59 and SEAD-71 Phase II RI Report
Seneca Army Depot Activity**

	SEAD-71		SEAD-71		SEAD-71		SEAD-71		SEAD-71		SEAD-71		SEAD-71		
	Location ID	MW71-1	MW71-3	MW71-4	MW71-2	MW71-4	MW71-1	MW71-1	MW71-1	MW71-3	MW71-3	MW71-3	MW71-3	MW71-3	
Matrix	GROUNDWATER	GROUNDWATER	GROUNDWATER	GROUNDWATER	GROUNDWATER	GROUNDWATER	GROUNDWATER	GROUNDWATER	GROUNDWATER	GROUNDWATER	GROUNDWATER	GROUNDWATER	GROUNDWATER	GROUNDWATER	
Sample ID	712000	712001	712003	712004	712006	712007	MW71-1	MW71-1	MW71-1	MW71-3	MW71-3	MW71-3	MW71-3	MW71-3	
Sample Depth to Top of Sample	8.4	7.51	20.67	0	0	0	4.3	4.3	4.3	3.5	3.5	3.5	3.5	3.5	
Sample Depth to Bottom of Sample	8.4	7.51	20.67	0	0	0	8.3	8.3	8.3	5.5	5.5	5.5	5.5	5.5	
Sample Date	4/6/2004	4/6/2004	4/5/2004	8/31/2004	8/31/2004	9/1/2004	3/29/1994	3/29/1994	3/29/1994	7/7/1994	7/7/1994	7/7/1994	7/7/1994	7/7/1994	
QC Code	SA	SA	SA / DU	SA	SA	SA	SA	SA	SA	SA	SA	SA	SA	SA	
Study ID	RI 2004	RI 2004	RI 2004	RI 2004	RI 2004	RI 2004	RI 2004	RI 2004	RI 2004	ESI	ESI	ESI	ESI	ESI	
	Criteria	Criteria	Criteria	Criteria	Criteria	Criteria	Criteria	Criteria	Criteria	Criteria	Criteria	Criteria	Criteria	Criteria	
	Units	Type ¹	Level	Value	(Q)	Value	(Q)	Value	(Q)	Value	(Q)	Value	(Q)	Value	(Q)

- (1) - (GA) NY State Class GA Groundwater Standard (TOGS 1.1.1, June 1998), except as noted below
 - (SEC) US EPA Secondary Drinking Water Regulation, non-enforceable (EPA 822-B-00-001, Summer 2000)
 - (MCL) US EPA Maximum Contaminant Limit, Source <http://www.epa.gov/safewater/mcl.html#inorganic.html>

- (2) - Sample-Duplicate pairs are presented as a combined sample in this table.
 Their Sample ID is a combination of the sample and the sample duplicate Sample ID (for example FD-59-CL-05/CL-59-01-WS1)
 In addition, the 'QC Code' field is labeled 'SADU'

U = compound was not detected

J = the reported value is an estimated concentration

UJ = the compound was not detected; the associated reporting limit is approximate

R = the data was rejected in the data validating process

NJ = compound was "tentatively identified" and the associated numerical value is approximate

Table A-6
SOIL SAMPLE RESULTS
SEAD-59 STOCKPILE
SEAD-59 and SEAD-71 Phase II RI Report
Seneca Army Depot Activity

Facility	SEAD-59	SEAD-59	SEAD-59	SEAD-59	SEAD-59							
Location ID	WS-59-01-005-4	WS-59-01-005-5	WS-59-01-006-1	FD-59-WS-03/WS-59-01-006-12	WS-59-01-006-3							
Maxtrix	SOIL	SOIL	SOIL	SOIL	SOIL							
Sample ID	WS-59-01-005-4	WS-59-01-005-5	WS-59-01-006-1	FD-59-WS-03/WS-59-01-006-12	WS-59-01-006-3							
Sample Depth to Top of Sample	0	0	0	0	0							
Sample Depth to Bottom of Sample	0	0	0	0	0							
Sample Date	5/6/2004	5/6/2004	5/6/2004	5/6/2004	5/6/2004							
QC Code	SA	SA	SA	SA/DU	SA							
Study ID	ENSR IRM	ENSR IRM	ENSR IRM	ENSR IRM	ENSR IRM							
	1	1	1	1	1							
Parameter	Units	Maximum Value	Frequency of Detection	NYSDEC TAGM Level	Number of Exceedances	Number of Times Detected	Number of Sample Analyses	ENSR IRM Value (Q)	ENSR IRM Value (Q)	ENSR IRM Value (Q)	ENSR IRM Value (Q)	ENSR IRM Value (Q)
Volatile Organics Compounds												
1,1,1-Trichloroethane	UG/KG	0	0%	800	0	0	53	5.7 U	5.8 U	5.7 U	5.6 U	5.5 U
1,1,2,2-Tetrachloroethane	UG/KG	0	0%	600	0	0	52	5.7 U	5.8 U	5.7 U	5.6 UJ	5.5 U
1,1,2-Trichloro-1,2,2-Trifluoroethane	UG/KG	1.5	2%		0	1	53	5.7 U	5.8 U	5.7 U	5.6 U	5.5 U
1,1,2-Trichloroethane	UG/KG	0	0%		0	0	5					
1,1-Dichloroethane	UG/KG	0	0%	200	0	0	53	5.7 U	5.8 U	5.7 U	5.6 U	5.5 U
1,1-Dichloroethene	UG/KG	1	2%	400	0	1	53	5.7 U	5.8 U	5.7 U	5.6 U	5.5 U
1,2,3-Trichloropropane	UG/KG	0	0%		0	0	47	5.7 U	5.8 U	5.7 U	5.6 UJ	5.5 U
1,2,4-Trichlorobenzene	UG/KG	0	0%	3400	0	0	52	5.7 U	5.8 U	5.7 U	5.6 UJ	5.5 U
1,2-Dibromo-3-chloropropane	UG/KG	0	0%		0	0	5					
1,2-Dibromoethane	UG/KG	0	0%		0	0	5					
1,2-Dichlorobenzene	UG/KG	0	0%	7900	0	0	52	5.7 U	5.8 U	5.7 U	5.6 UJ	5.5 U
1,2-Dichloroethane	UG/KG	0	0%	100	0	0	53	5.7 U	5.8 U	5.7 U	5.6 U	5.5 U
1,2-Dichloropropane	UG/KG	0	0%		0	0	5					
1,3-Dichlorobenzene	UG/KG	0	0%	1600	0	0	52	5.7 U	5.8 U	5.7 U	5.6 UJ	5.5 U
1,3-Dichloropropane	UG/KG	0	0%		0	0	48	5.7 U	5.8 U	5.7 U	5.6 U	5.5 U
1,4-Dichlorobenzene	UG/KG	0	0%	8500	0	0	52	5.7 U	5.8 U	5.7 U	5.6 UJ	5.5 U
Acetone	UG/KG	69	25%	200	0	13	53	23 U	23 U	23 U	22.5 U	46
Benzene	UG/KG	0	0%	60	0	0	53	5.7 U	5.8 U	5.7 U	5.6 U	5.5 U
Bromodichloromethane	UG/KG	0	0%		0	0	5					
Bromoform	UG/KG	0	0%		0	0	5					
Carbon disulfide	UG/KG	0	0%	2700	0	0	53	5.7 U	5.8 U	5.7 U	5.6 U	5.5 U
Carbon tetrachloride	UG/KG	0	0%	600	0	0	53	5.7 U	5.8 U	5.7 U	5.6 U	5.5 U
Chlorobenzene	UG/KG	0	0%	1700	0	0	53	5.7 U	5.8 U	5.7 U	5.6 U	5.5 U
Chlorodibromomethane	UG/KG	0	0%		0	0	53	5.7 U	5.8 U	5.7 U	5.6 U	5.5 U
Chloroethane	UG/KG	0	0%	1900	0	0	53	11 U	12 U	11 U	11 U	11 U
Chloroform	UG/KG	0	0%	300	0	0	53	5.7 U	5.8 U	5.7 U	5.6 U	5.5 U
Cis-1,2-Dichloroethene	UG/KG	0	0%		0	0	5					
Cis-1,3-Dichloropropene	UG/KG	0	0%		0	0	5					
Cyclohexane	UG/KG	0	0%		0	0	5					
Dichlorodifluoromethane	UG/KG	0	0%		0	0	5					
Ethyl benzene	UG/KG	0	0%	5500	0	0	53	5.7 U	5.8 U	5.7 U	5.6 U	5.5 U
Isopropylbenzene	UG/KG	0	0%		0	0	5					
Meta/Para Xylene	UG/KG	2.3	4%		0	2	48	5.7 U	5.8 U	5.7 U	5.6 U	5.5 U
Methyl Acetate	UG/KG	0	0%		0	0	5					
Methyl Tertbutyl Ether	UG/KG	0	0%		0	0	5					
Methyl bromide	UG/KG	0	0%		0	0	5					
Methyl butyl ketone	UG/KG	0	0%		0	0	5					
Methyl chloride	UG/KG	0	0%		0	0	5					
Methyl cyclohexane	UG/KG	0	0%		0	0	5					
Methyl ethyl ketone	UG/KG	7	9%	300	0	5	53	11 U	12 U	11 U	11 U	11 U
Methyl isobutyl ketone	UG/KG	0	0%	1000	0	0	53	11 U	12 U	11 U	11 U	11 U
Methylene chloride	UG/KG	3.45	2%	100	0	1	53	5.7 U	5.8 U	5.7 U	3.45 J	5.5 U
Ortho Xylene	UG/KG	1.9	10%		0	5	48	5.7 U	5.8 U	5.7 U	5.6 U	5.5 U
Styrene	UG/KG	0	0%		0	0	5					
Tetrachloroethene	UG/KG	6.7	6%	1400	0	3	53	5.7 U	5.8 U	5.7 U	5.6 U	5.5 U
Toluene	UG/KG	0	0%	1500	0	0	53	5.7 U	5.8 U	5.7 U	5.6 U	5.5 U
Total Xylenes	UG/KG	3	20%	1200	0	1	5					
Trans-1,2-Dichloroethene	UG/KG	0	0%	300	0	0	53	5.7 U	5.8 U	5.7 U	5.6 U	5.5 U

Table A-6
SOIL SAMPLE RESULTS
SEAD-59 STOCKPILE
SEAD-59 and SEAD-71 Phase II RI Report
Seneca Army Depot Activity

Facility	SEAD-59		SEAD-59		SEAD-59		SEAD-59		SEAD-59	
Location ID	WS-59-01-005-4		WS-59-01-005-5		WS-59-01-006-1		FD-59-WS-03/WS-59-01-006-12		WS-59-01-006-3	
Maxtrix	SOIL		SOIL		SOIL		SOIL		SOIL	
Sample ID	WS-59-01-005-4		WS-59-01-005-5		WS-59-01-006-1		FD-59-WS-03/WS-59-01-006-12		WS-59-01-006-3	
Sample Depth to Top of Sample	0		0		0		0		0	
Sample Depth to Bottom of Sample	0		0		0		0		0	
Sample Date	5/6/2004		5/6/2004		5/6/2004		5/6/2004		5/6/2004	
QC Code	SA		SA		SA		SA/DU		SA	
Study ID	ENSR IRM		ENSR IRM		ENSR IRM		ENSR IRM		ENSR IRM	
	Maximum	Frequency	NYSDEC	Number	Number	Number				
Parameter	Value	of	TAGM	of	of Times	of Sample	ENSR IRM	ENSR IRM	ENSR IRM	ENSR IRM
Units		Detection	Level	Exceedances	Detected	Analyses	1	1	1	1
							Value (Q)	Value (Q)	Value (Q)	Value (Q)
Trans-1,3-Dichloropropene	UG/KG	0	0%	700	0	5				
Trichloroethene	UG/KG	4.2	8%	700	0	53	5.7 U	5.8 U	5.7 U	4.2 J
Trichlorofluoromethane	UG/KG	0	0%		0	5				5.5 U
Vinyl chloride	UG/KG	0	0%	200	0	53	11 U	12 U	11 U	11 U
Semivolatile Organics Compounds										
1,1'-Biphenyl	UG/KG	59	20%		0	5				
2,2'-oxybis(1-Chloropropane)	UG/KG	0	0%		0	5				
2,4,5-Trichlorophenol	UG/KG	0	0%	100	0	53	760 U	380 U	1900 U	1850 U
2,4,6-Trichlorophenol	UG/KG	0	0%		0	53	760 U	380 U	1900 U	1850 U
2,4-Dichlorophenol	UG/KG	0	0%	400	0	53	760 U	380 U	1900 U	1850 U
2,4-Dimethylphenol	UG/KG	0	0%		0	5				
2,4-Dinitrophenol	UG/KG	0	0%	200	0	53	3900 U	2000 U	9600 U	9450 U
2,4-Dinitrotoluene	UG/KG	0	0%		0	53	760 U	380 U	1900 U	1850 U
2,6-Dinitrotoluene	UG/KG	0	0%	1000	0	53	760 U	380 U	1900 U	1850 U
2-Chloronaphthalene	UG/KG	0	0%		0	5				
2-Chlorophenol	UG/KG	0	0%	800	0	53	760 U	380 U	1900 U	1850 U
2-Methylnaphthalene	UG/KG	1200	51%	36400	0	27	53	760 U	380 U	1900 U
2-Methylphenol	UG/KG	0	0%	100	0	53	760 U	380 U	1900 U	1850 U
2-Nitroaniline	UG/KG	0	0%	430	0	53	3900 U	2000 U	9600 U	9450 U
2-Nitrophenol	UG/KG	0	0%	330	0	53	760 U	380 U	1900 U	1850 U
3,3'-Dichlorobenzidine	UG/KG	0	0%		0	53	760 U	380 U	1900 U	1850 U
3-Nitroaniline	UG/KG	0	0%	500	0	53	3900 U	2000 U	9600 U	9450 U
4,6-Dinitro-2-methylphenol	UG/KG	0	0%		0	5				
4-Bromophenyl phenyl ether	UG/KG	0	0%		0	5				
4-Chloro-3-methylphenol	UG/KG	0	0%	240	0	53	760 U	380 U	1900 U	1850 U
4-Chloroaniline	UG/KG	0	0%	220	0	53	760 U	380 U	1900 U	1850 U
4-Chlorophenyl phenyl ether	UG/KG	0	0%		0	5				
4-Methylphenol	UG/KG	0	0%	900	0	53	760 U	380 U	1900 U	1850 U
4-Nitroaniline	UG/KG	0	0%		0	5				
4-Nitrophenol	UG/KG	0	0%	100	0	53	3900 U	2000 U	9600 U	9450 U
Acenaphthene	UG/KG	2400	87%	50000	0	46	53	110 J	380 U	360 J
Acenaphthylene	UG/KG	3500	98%	41000	0	52	53	690 J	180 J	2400
Acetophenone	UG/KG	0	0%		0	5				
Aniline	UG/KG	0	0%		0	48	760 U	380 U	1900 U	1850 U
Anthracene	UG/KG	6600	100%	50000	0	53	53	730 J	150 J	2300
Atrazine	UG/KG	0	0%		0	5				
Benzaldehyde	UG/KG	0	0%		0	5				
Benzo(a)anthracene	UG/KG	14000	100%	224	52	53	53	1700	440	5500
Benzo(a)pyrene	UG/KG	16000	100%	61	53	53	53	1800	500	6000
Benzo(b)fluoranthene	UG/KG	11000	100%	1100	46	53	53	1200	400	4000
Benzo(ghi)perylene	UG/KG	8000	100%	50000	0	53	53	910	400	4100
Benzo(k)fluoranthene	UG/KG	13000	100%	1100	46	53	53	1300	380 J	4300
Benzoic Acid	UG/KG	0	0%	2700	0	48	48	3900 U	2000 U	9600 U
Bis(2-Chloroethoxy)methane	UG/KG	0	0%		0	5				
Bis(2-Chloroethyl)ether	UG/KG	0	0%		0	5				
Bis(2-Ethylhexyl)phthalate	UG/KG	130	6%	50000	0	3	53	760 U	380 U	1900 U
Butylbenzylphthalate	UG/KG	0	0%	50000	0	0	53	760 U	380 U	1900 U
Caprolactam	UG/KG	0	0%		0	5				
Carbazole	UG/KG	1100	80%		0	4	5			

Table A-6
SOIL SAMPLE RESULTS
SEAD-59 STOCKPILE
SEAD-59 and SEAD-71 Phase II RI Report
Seneca Army Depot Activity

Facility	SEAD-59		SEAD-59		SEAD-59		SEAD-59		SEAD-59			
Location ID	WS-59-01-005-4		WS-59-01-005-5		WS-59-01-006-1		FD-59-WS-03/WS-59-01-006-12		WS-59-01-006-3			
Maxtrix	SOIL		SOIL		SOIL		SOIL		SOIL			
Sample ID	WS-59-01-005-4		WS-59-01-005-5		WS-59-01-006-1		FD-59-WS-03/WS-59-01-006-12		WS-59-01-006-3			
Sample Depth to Top of Sample	0		0		0		0		0			
Sample Depth to Bottom of Sample	0		0		0		0		0			
Sample Date	5/6/2004		5/6/2004		5/6/2004		5/6/2004		5/6/2004			
QC Code	SA		SA		SA		SA/DU		SA			
Study ID	ENSR IRM		ENSR IRM		ENSR IRM		ENSR IRM		ENSR IRM			
	1		1		1		1		1			
Parameter	Units	Maximum Value	Frequency of Detection	NYSDEC TAGM Level	Number of Exceedances	Number of Times Detected	Number of Sample Analyses	Value (Q)	Value (Q)	Value (Q)	Value (Q)	Value (Q)
Chrysene	UG/KG	13000	100%	400	52	53	53	1700	460	5300	3550	5400
Di-n-butylphthalate	UG/KG	0	0%	8100	0	0	53	760 U	380 U	1900 U	1850 U	1800 U
Di-n-octylphthalate	UG/KG	0	0%	50000	0	0	53	760 U	380 U	1900 U	1850 U	1800 U
Dibenz(a,h)anthracene	UG/KG	2900	98%	14	52	52	53	310 J	120 J	1400 J	1030 J	1600 J
Dibenzofuran	UG/KG	1300	62%	6200	0	33	53	760 U	380 U	1900 U	1850 U	210 J
Diethyl phthalate	UG/KG	0	0%	7100	0	0	53	760 U	380 U	1900 U	1850 U	1800 U
Dimethylphthalate	UG/KG	0	0%	2000	0	0	53	760 U	380 U	1900 U	1850 U	1800 U
Fluoranthene	UG/KG	29000	100%	50000	0	53	53	2900	840	9900	6600 J	11000
Fluorene	UG/KG	3100	89%	50000	0	47	53	160 J	380 U	510 J	1185 J	490 J
Hexachlorobenzene	UG/KG	0	0%	410	0	0	53	760 U	380 U	1900 U	1850 U	1800 U
Hexachlorobutadiene	UG/KG	0	0%	0	0	0	53	760 U	380 U	1900 U	1850 U	1800 U
Hexachlorocyclopentadiene	UG/KG	0	0%	0	0	0	5					
Hexachloroethane	UG/KG	0	0%	0	0	0	53	760 U	380 U	1900 U	1850 U	1800 U
Indeno(1,2,3-cd)pyrene	UG/KG	8000	100%	3200	19	53	53	860	350 J	3600 J	2800 J	4500 J
Isophorone	UG/KG	0	0%	4400	0	0	53	760 U	380 U	1900 U	1850 U	1800 U
N-Nitrosodiphenylamine	UG/KG	0	0%	0	0	0	5					
N-Nitrosodipropylamine	UG/KG	0	0%	0	0	0	5					
Naphthalene	UG/KG	1200	62%	13000	0	33	53	760 U	380 U	1900 U	1850 U	1800 U
Nitrobenzene	UG/KG	0	0%	200	0	0	53	760 U	380 U	1900 U	1850 U	1800 U
Pentachlorophenol	UG/KG	660	2%	1000	0	1	53	3900 U	2000 U	9600 U	9450 U	9400 U
Phenanthrene	UG/KG	17000	100%	50000	0	53	53	1600	370 J	5200	3450 J	5300
Phenol	UG/KG	0	0%	30	0	0	53	760 U	380 U	1900 U	1850 U	1800 U
Pyrene	UG/KG	22000	100%	50000	0	53	53	2500	820	9500	6250 J	9600
Pyridine	UG/KG	0	0%	0	0	0	48	3900 U	2000 U	9600 U	9450 U	9400 U
Pesticides/PCBs												
4,4'-DDD	UG/KG	450	62%	2900	0	33	53	25 J	19 U	23	69 J	20
4,4'-DDE	UG/KG	230	62%	2100	0	33	53	100	96	140 J	139 J	110 J
4,4'-DDT	UG/KG	520	70%	2100	0	37	53	150	78	110	269 J	52 J
Aldrin	UG/KG	0	0%	41	0	0	53	9.7 U	9.9 U	9.6 U	23.65 U	9.4 U
Alpha-BHC	UG/KG	4.4	2%	110	0	1	53	9.7 U	9.9 U	9.6 U	23.65 U	9.4 U
Alpha-Chlordane	UG/KG	27	11%	0	0	6	53	9.7 U	23 J	9.6 U	23.65 U	9.4 U
Beta-BHC	UG/KG	13	2%	200	0	1	53	9.7 U	9.9 U	9.6 U	23.65 U	9.4 U
Delta-BHC	UG/KG	0	0%	300	0	0	53	9.7 U	9.9 U	9.6 U	23.65 U	9.4 U
Dieldrin	UG/KG	0	0%	44	0	0	53	19 U	19 U	19 U	46.5 U	18 U
Endosulfan I	UG/KG	0	0%	900	0	0	53	9.7 U	9.9 U	9.6 U	23.65 U	9.4 U
Endosulfan II	UG/KG	0	0%	900	0	0	53	19 U	19 U	19 U	46.5 U	18 U
Endosulfan sulfate	UG/KG	0	0%	1000	0	0	53	19 U	19 U	19 U	46.5 U	18 U
Endrin	UG/KG	0	0%	100	0	0	53	19 U	19 U	19 U	46.5 U	18 U
Endrin aldehyde	UG/KG	0	0%	0	0	0	53	19 U	19 U	19 U	46.5 U	18 U
Endrin ketone	UG/KG	15	2%	0	0	1	53	19 U	19 U	19 U	46.5 U	18 U

**Table A-6
SOIL SAMPLE RESULTS
SEAD-59 STOCKPILE
SEAD-59 and SEAD-71 Phase II RI Report
Seneca Army Depot Activity**

Facility	Location ID	SEAD-59		SEAD-59		SEAD-59		SEAD-59		SEAD-59	
		WS-59-01-005-4	WS-59-01-005-5	WS-59-01-006-1	FD-59-WS-03/WS-59-01-006-12	WS-59-01-006-3					
Maxtrix	Sample ID	SOIL		SOIL		SOIL		SOIL		SOIL	
Sample Depth to Top of Sample	Sample ID	WS-59-01-005-4		WS-59-01-005-5		WS-59-01-006-1		FD-59-WS-03/WS-59-01-006-12		WS-59-01-006-3	
Sample Depth to Bottom of Sample	Sample Date	0		0		0		0		0	
Sample Date	QC Code	5/6/2004		5/6/2004		5/6/2004		5/6/2004		5/6/2004	
QC Code	Study ID	SA		SA		SA		SA/DU		SA	
Study ID	Maximum Value	Frequency of Detection	NYSDEC TAGM Level	Number of Exceedances	Number of Times Detected	Number of Sample Analyses	ENSR IRM 1	ENSR IRM 1	ENSR IRM 1	ENSR IRM 1	ENSR IRM 1
Parameter	Units	Value	Level	Exceedances	Detected	Analyses	Value (Q)	Value (Q)	Value (Q)	Value (Q)	Value (Q)
Gamma-BHC/Lindane	UG/KG	0	0%	60	0	53	9.7 U	9.9 U	9.6 U	23.65 U	9.4 U
Gamma-Chlordane	UG/KG	21	9%	540	0	5	9.7 U	21 J	9.6 U	23.65 U	9.4 U
Heptachlor	UG/KG	0	0%	100	0	0	9.7 U	9.9 U	9.6 U	23.65 U	9.4 U
Heptachlor epoxide	UG/KG	0	0%	20	0	0	9.7 U	9.9 U	9.6 U	23.65 U	9.4 U
Methoxychlor	UG/KG	0	0%		0	0	97 U	99 U	96 U	236.5 U	94 U
Toxaphene	UG/KG	0	0%		0	0	190 U	190 U	190 U	465 U	180 U
Aroclor-1016	UG/KG	0	0%		0	0	38 U	38 U	37 U	36.5 U	36 U
Aroclor-1221	UG/KG	0	0%		0	0	38 U	38 U	37 U	36.5 U	36 U
Aroclor-1232	UG/KG	0	0%		0	0	38 U	38 U	37 U	36.5 U	36 U
Aroclor-1242	UG/KG	0	0%		0	0	38 U	38 U	37 U	36.5 U	36 U
Aroclor-1248	UG/KG	0	0%		0	0	38 U	38 U	37 U	36.5 U	36 U
Aroclor-1254	UG/KG	0	0%	10000	0	0	38 U	38 U	37 U	36.5 U	36 U
Aroclor-1260	UG/KG	0	0%	10000	0	0	38 U	38 U	37 U	36.5 U	36 U
Metals											
Aluminum	MG/KG	13400	100%	19300	0	53	11000	13400	9740	10305	11900
Antimony	MG/KG	43.9	21%	5.9	3	11	3.4 UJ	3.4 UJ	3.4 UJ	3.3 UJ	3.3 UJ
Arsenic	MG/KG	7.3	100%	8.2	0	53	4.1	5.4	4.5	5.3 J	5.1
Barium	MG/KG	135	100%	300	0	53	88.1	128	93.5	82.6	99.5
Beryllium	MG/KG	0.69	100%	1.1	0	53	0.69	0.16	0.2	0.27	0.21
Cadmium	MG/KG	1.2	98%	2.3	0	52	0.28 U	0.67	0.57 J	0.635	0.43 J
Calcium	MG/KG	100000	100%	121000	0	53	25000	17500	45300	55950	70600
Chromium	MG/KG	35	100%	29.6	3	53	19	20.6	25.6	17.9	19.1
Cobalt	MG/KG	13.9	100%	30	0	53	8.6	10.2	9.1	10.6	10.5
Copper	MG/KG	51.8	100%	33	14	53	30.5 J	31.8	32.3	28.65 J	31.3
Iron	MG/KG	26500	100%	36500	0	53	20600	22200	18800	18850	21500
Lead	MG/KG	1440	100%	24.8	51	53	55.3 J	38.1	82.9	60	56.7
Magnesium	MG/KG	26600	100%	21500	1	53	5680	6320	7410	8545	8340
Manganese	MG/KG	1220	100%	1060	2	53	387	529	451	495	642
Mercury	MG/KG	0.52	100%	0.1	9	53	0.08	0.1	0.06	0.05	0.05
Nickel	MG/KG	56.6	100%	49	1	53	25.5	26.5	26.3	28.45	26.5
Potassium	MG/KG	1580	100%	2380	0	53	1180	1320	1060	1055	1190
Selenium	MG/KG	0.72	4%	2	0	2	0.57 U	0.56 U	0.57 UJ	0.55 U	0.54 UJ
Silver	MG/KG	4.7	17%	0.75	6	9	0.57 U	0.6 J	0.57 U	0.55 UJ	0.54 U
Sodium	MG/KG	525	100%	172	23	53	111	68.5	93	163	107
Thallium	MG/KG	0.99	51%	0.7	12	27	0.57 U	0.87 J	0.57 U	0.55 U	0.69 J
Vanadium	MG/KG	35.4	100%	150	0	53	20.1	23	17.1	18.45	20.6
Zinc	MG/KG	185	100%	110	6	53	81.9 J	87.9	89.8	111.1 J	110

Note(s):

(1) - NYSDEC Technical and Administrative Guidance Memorandum (TAGM) HWR-94-4046, Revised January 24, 1994

(2) - Sample-Duplicate pairs are presented as a combined sample in this table.

Their Sample ID is a combination of the sample and the sample duplicate Sample ID (for example FD-59-CL-05/CL-59-01-WS1)

In addition, the 'QC Code' field is labeled 'SADU'

U = compound was not detected

J = the reported value is an estimated concentration

UJ = the compound was not detected; the associated reporting limit is approximate

R = the data was rejected in the data validating process

NJ = compound was "tentatively identified" and the associated numerical value is approximate

Table A-6
SOIL SAMPLE RESULTS
SEAD-59 STOCKPILE
SEAD-59 and SEAD-71 Phase II RI Report
Seneca Army Depot Activity

Facility	Location ID	SEAD-59	SEAD-59	SEAD-59	SEAD-59	SEAD-59	SEAD-59	SEAD-59	SEAD-59	SEAD-59			
Matrix	Sample ID	WS-59-01-006-7	WS-59-01-006-9	WS-59-01-007-1	WS-59-01-007-10	WS-59-01-007-11	WS-59-01-007-12	WS-59-01-006-7	WS-59-01-006-9	WS-59-01-007-1			
Sample Depth to Top of Sample	Sample Date	SOIL	SOIL	SOIL	SOIL	SOIL	SOIL	SOIL	SOIL	SOIL			
Sample Depth to Bottom of Sample	QC Code	0	0	0	0	0	0	0	0	0			
Study ID	Study ID	5/6/2004	5/6/2004	5/6/2004	5/6/2004	5/6/2004	5/6/2004	5/6/2004	5/6/2004	5/6/2004			
Parameter	Units	SA	SA	SA	SA	SA	SA	SA	SA	SA			
	Maximum Value	Frequency of Detection	NYSDEC TAGM Level	Number of Exceedances	Number of Times Detected	Number of Sample Analyses	ENSR IRM 1	ENSR IRM 1	ENSR IRM 1	ENSR IRM 1	ENSR IRM 1	ENSR IRM 1	
	Value						Value (Q)	Value (Q)	Value (Q)	Value (Q)	Value (Q)	Value (Q)	
Volatile Organics Compounds													
1,1,1-Trichloroethane	UG/KG	0	0%	800	0	0	53	5.7 U	5.7 U	5.8 U	5.6 U	5.8 U	5.6 U
1,1,2,2-Tetrachloroethane	UG/KG	0	0%	600	0	0	52	5.7 U	5.7 R	5.8 U	5.6 U	5.8 U	5.6 U
1,1,2-Trichloro-1,2,2-Trifluoroethane	UG/KG	1.5	2%		0	1	53	5.7 U	5.7 U	5.8 U	5.6 U	5.8 U	5.6 U
1,1,2-Trichloroethane	UG/KG	0	0%		0	0	5						
1,1-Dichloroethane	UG/KG	0	0%	200	0	0	53	5.7 U	5.7 U	5.8 U	5.6 U	5.8 U	5.6 U
1,1-Dichloroethene	UG/KG	1	2%	400	0	1	53	5.7 U	5.7 U	5.8 U	5.6 U	5.8 U	5.6 U
1,2,3-Trichloropropane	UG/KG	0	0%		0	0	47	5.7 U	5.7 R	5.8 U	5.6 U	5.8 U	5.6 U
1,2,4-Trichlorobenzene	UG/KG	0	0%	3400	0	0	52	5.7 U	5.7 R	5.8 U	5.6 U	5.8 U	5.6 U
1,2-Dibromo-3-chloropropane	UG/KG	0	0%		0	0	5						
1,2-Dibromoethane	UG/KG	0	0%		0	0	5						
1,2-Dichlorobenzene	UG/KG	0	0%	7900	0	0	52	5.7 U	5.7 R	5.8 U	5.6 U	5.8 U	5.6 U
1,2-Dichloroethane	UG/KG	0	0%	100	0	0	53	5.7 U	5.7 U	5.8 U	5.6 U	5.8 U	5.6 U
1,2-Dichloropropane	UG/KG	0	0%		0	0	5						
1,3-Dichlorobenzene	UG/KG	0	0%	1600	0	0	52	5.7 U	5.7 R	5.8 U	5.6 U	5.8 U	5.6 U
1,3-Dichloropropane	UG/KG	0	0%		0	0	48	5.7 U	5.7 UJ	5.8 U	5.6 U	5.8 U	5.6 U
1,4-Dichlorobenzene	UG/KG	0	0%	8500	0	0	52	5.7 U	5.7 R	5.8 U	5.6 U	5.8 U	5.6 U
Acetone	UG/KG	69	25%	200	0	13	53	4.8 J	5.4 J	25	17 J	23 U	22 U
Benzene	UG/KG	0	0%	60	0	0	53	5.7 U	5.7 U	5.8 U	5.6 U	5.8 U	5.6 U
Bromodichloromethane	UG/KG	0	0%		0	0	5						
Bromoform	UG/KG	0	0%		0	0	5						
Carbon disulfide	UG/KG	0	0%	2700	0	0	53	5.7 U	5.7 U	5.8 U	5.6 U	5.8 U	5.6 U
Carbon tetrachloride	UG/KG	0	0%	600	0	0	53	5.7 U	5.7 U	5.8 U	5.6 U	5.8 U	5.6 U
Chlorobenzene	UG/KG	0	0%	1700	0	0	53	5.7 U	5.7 UJ	5.8 U	5.6 U	5.8 U	5.6 U
Chlorodibromomethane	UG/KG	0	0%		0	0	53	5.7 U	5.7 UJ	5.8 U	5.6 U	5.8 U	5.6 U
Chloroethane	UG/KG	0	0%	1900	0	0	53	11 U	11 U	12 U	11 U	12 U	11 U
Chloroform	UG/KG	0	0%	300	0	0	53	5.7 U	5.7 U	5.8 U	5.6 U	5.8 U	5.6 U
Cis-1,2-Dichloroethene	UG/KG	0	0%		0	0	5						
Cis-1,3-Dichloropropene	UG/KG	0	0%		0	0	5						
Cyclohexane	UG/KG	0	0%		0	0	5						
Dichlorodifluoromethane	UG/KG	0	0%		0	0	5						
Ethyl benzene	UG/KG	0	0%	5500	0	0	53	5.7 U	5.7 UJ	5.8 U	5.6 U	5.8 U	5.6 U
Isopropylbenzene	UG/KG	0	0%		0	0	5						
Meta/Para Xylene	UG/KG	2.3	4%		0	2	48	5.7 U	5.7 UJ	5.8 U	5.6 U	5.8 U	5.6 U
Methyl Acetate	UG/KG	0	0%		0	0	5						
Methyl Tertbutyl Ether	UG/KG	0	0%		0	0	5						
Methyl bromide	UG/KG	0	0%		0	0	5						
Methyl butyl ketone	UG/KG	0	0%		0	0	5						
Methyl chloride	UG/KG	0	0%		0	0	5						
Methyl cyclohexane	UG/KG	0	0%		0	0	5						
Methyl ethyl ketone	UG/KG	7	9%	300	0	5	53	11 U	11 U	2.7 J	4.6 J	12 U	11 U
Methyl isobutyl ketone	UG/KG	0	0%	1000	0	0	53	11 U	11 U	12 U	11 U	12 U	11 U
Methylene chloride	UG/KG	3.45	2%	100	0	1	53	5.7 U	5.7 U	5.8 U	5.6 U	5.8 U	5.6 U
Ortho Xylene	UG/KG	1.9	10%		0	5	48	5.7 U	5.7 UJ	5.8 U	5.6 U	5.8 U	5.6 U
Styrene	UG/KG	0	0%		0	0	5						
Tetrachloroethene	UG/KG	6.7	6%	1400	0	3	53	5.7 U	5.7 UJ	5.8 U	5.6 U	5.8 U	5.6 U
Toluene	UG/KG	0	0%	1500	0	0	53	5.7 U	5.7 UJ	5.8 U	5.6 U	5.8 U	5.6 U
Total Xylenes	UG/KG	3	20%	1200	0	1	5						
Trans-1,2-Dichloroethene	UG/KG	0	0%	300	0	0	53	5.7 U	5.7 U	5.8 U	5.6 U	5.8 U	5.6 U

**Table A-6
SOIL SAMPLE RESULTS
SEAD-59 STOCKPILE
SEAD-59 and SEAD-71 Phase II RI Report
Seneca Army Depot Activity**

Facility	Location ID	SEAD-59	SEAD-59	SEAD-59	SEAD-59	SEAD-59	SEAD-59						
Matrix	Sample ID	WS-59-01-006-7	WS-59-01-006-9	WS-59-01-007-1	WS-59-01-007-10	WS-59-01-007-11	WS-59-01-007-12						
Sample Depth to Top of Sample	Sample Depth to Bottom of Sample	SOIL	SOIL	SOIL	SOIL	SOIL	SOIL						
Sample Date	QC Code	WS-59-01-006-7	WS-59-01-006-9	WS-59-01-007-1	WS-59-01-007-10	WS-59-01-007-11	WS-59-01-007-12						
Study ID	Study ID	0	0	0	0	0	0						
		0	0	0	0	0	0						
		5/6/2004	5/6/2004	5/6/2004	5/6/2004	5/6/2004	5/6/2004						
		SA	SA	SA	SA	SA	SA						
		ENSR IRM	ENSR IRM	ENSR IRM	ENSR IRM	ENSR IRM	ENSR IRM						
		1	1	1	1	1	1						
		Value (Q)	Value (Q)	Value (Q)	Value (Q)	Value (Q)	Value (Q)						
Parameter	Units	Maximum Value	Frequency of Detection	NYSDEC TAGM Level	Number of Exceedances	Number of Times Detected	Number of Sample Analyses	Value (Q)	Value (Q)	Value (Q)	Value (Q)	Value (Q)	Value (Q)
Trans-1,3-Dichloropropene	UG/KG	0	0%		0	0	5						
Trichloroethene	UG/KG	4.2	8%	700	0	4	53	1.1 J	1.7 J	5.8 U	5.6 U	5.8 U	5.6 U
Trichlorofluoromethane	UG/KG	0	0%		0	0	5						
Vinyl chloride	UG/KG	0	0%	200	0	0	53	11 UJ	11 UJ	12 U	11 U	12 U	11 U
Semivolatile Organics Compounds													
1,1'-Biphenyl	UG/KG	59	20%		0	1	5						
2,2'-oxybis(1-Chloropropane)	UG/KG	0	0%		0	0	5						
2,4,5-Trichlorophenol	UG/KG	0	0%	100	0	0	53	1900 U	3800 U	1900 U	1800 U	1900 U	1900 U
2,4,6-Trichlorophenol	UG/KG	0	0%		0	0	53	1900 U	3800 U	1900 U	1800 U	1900 U	1900 U
2,4-Dichlorophenol	UG/KG	0	0%	400	0	0	53	1900 U	3800 U	1900 U	1800 U	1900 U	1900 U
2,4-Dimethylphenol	UG/KG	0	0%		0	0	5						
2,4-Dinitrophenol	UG/KG	0	0%	200	0	0	53	9700 U	19000 UJ	9900 U	9500 U	9900 U	9600 U
2,4-Dinitrotoluene	UG/KG	0	0%		0	0	53	1900 U	3800 U	1900 U	1800 U	1900 U	1900 U
2,6-Dinitrotoluene	UG/KG	0	0%	1000	0	0	53	1900 U	3800 U	1900 U	1800 U	1900 U	1900 U
2-Chloronaphthalene	UG/KG	0	0%		0	0	5						
2-Chlorophenol	UG/KG	0	0%	800	0	0	53	1900 U	3800 U	1900 U	1800 U	1900 U	1900 U
2-Methylnaphthalene	UG/KG	1200	51%	36400	0	27	53	210 J	3800 U	1200 J	1800 U	1900 U	290 J
2-Methylphenol	UG/KG	0	0%	100	0	0	53	1900 U	3800 U	1900 U	1800 U	1900 U	1900 U
2-Nitroaniline	UG/KG	0	0%	430	0	0	53	9700 U	19000 U	9900 U	9500 U	9900 U	9600 U
2-Nitrophenol	UG/KG	0	0%	330	0	0	53	1900 U	3800 U	1900 U	1800 U	1900 U	1900 U
3,3'-Dichlorobenzidine	UG/KG	0	0%		0	0	53	1900 U	3800 U	1900 U	1800 U	1900 U	1900 U
3-Nitroaniline	UG/KG	0	0%	500	0	0	53	9700 U	19000 U	9900 U	9500 U	9900 U	9600 U
4,6-Dinitro-2-methylphenol	UG/KG	0	0%		0	0	5						
4-Bromophenyl phenyl ether	UG/KG	0	0%		0	0	5						
4-Chloro-3-methylphenol	UG/KG	0	0%	240	0	0	53	1900 U	3800 U	1900 U	1800 U	1900 U	1900 U
4-Chloroaniline	UG/KG	0	0%	220	0	0	53	1900 U	3800 U	1900 U	1800 U	1900 U	1900 U
4-Chlorophenyl phenyl ether	UG/KG	0	0%		0	0	5						
4-Methylphenol	UG/KG	0	0%	900	0	0	53	1900 U	3800 U	1900 U	1800 U	1900 U	1900 U
4-Nitroaniline	UG/KG	0	0%		0	0	5						
4-Nitrophenol	UG/KG	0	0%	100	0	0	53	9700 U	19000 U	9900 U	9500 U	9900 U	9600 U
Acenaphthene	UG/KG	2400	87%	50000	0	46	53	460 J	440 J	720 J	250 J	370 J	580 J
Acenaphthylene	UG/KG	3500	98%	41000	0	52	53	2000	1600 J	2700	960 J	1300 J	2200
Acetophenone	UG/KG	0	0%		0	0	5						
Aniline	UG/KG	0	0%		0	0	48	1900 U	3800 U	1900 U	1800 U	1900 U	1900 U
Anthracene	UG/KG	6600	100%	50000	0	53	53	1900	2000 J	2800	880 J	1300 J	2300
Atrazine	UG/KG	0	0%		0	0	5						
Benzaldehyde	UG/KG	0	0%		0	0	5						
Benzo(a)anthracene	UG/KG	14000	100%	224	52	53	53	4300	5600	5200	2200	3000	5400
Benzo(a)pyrene	UG/KG	16000	100%	61	53	53	53	5400	7400	5400	2700	3100	5900
Benzo(b)fluoranthene	UG/KG	11000	100%	1100	46	53	53	3900	5400	3600	2000	2300	4300
Benzo(ghi)perylene	UG/KG	8000	100%	50000	0	53	53	4200	4900	3300	1700 J	1600 J	2900
Benzo(k)fluoranthene	UG/KG	13000	100%	1100	46	53	53	3700	5400	3600	2000	2400	4500
Benzoic Acid	UG/KG	0	0%	2700	0	0	48	9700 UJ	19000 U	9900 UJ	9500 U	9900 U	9600 U
Bis(2-Chloroethoxy)methane	UG/KG	0	0%		0	0	5						
Bis(2-Chloroethyl)ether	UG/KG	0	0%		0	0	5						
Bis(2-Ethylhexyl)phthalate	UG/KG	130	6%	50000	0	3	53	1900 U	3800 U	1900 U	1800 U	1900 U	1900 U
Butylbenzylphthalate	UG/KG	0	0%	50000	0	0	53	1900 U	3800 U	1900 U	1800 UJ	1900 UJ	1900 UJ
Caprolactam	UG/KG	0	0%		0	0	5						
Carbazole	UG/KG	1100	80%		0	4	5						

Table A-6
SOIL SAMPLE RESULTS
SEAD-59 STOCKPILE
SEAD-59 and SEAD-71 Phase II RI Report
Seneca Army Depot Activity

Facility							SEAD-59	SEAD-59	SEAD-59	SEAD-59	SEAD-59	SEAD-59	
Location ID							WS-59-01-006-7	WS-59-01-006-9	WS-59-01-007-1	WS-59-01-007-10	WS-59-01-007-11	WS-59-01-007-12	
Matrix							SOIL	SOIL	SOIL	SOIL	SOIL	SOIL	
Sample ID							WS-59-01-006-7	WS-59-01-006-9	WS-59-01-007-1	WS-59-01-007-10	WS-59-01-007-11	WS-59-01-007-12	
Sample Depth to Top of Sample							0	0	0	0	0	0	
Sample Depth to Bottom of Sample							0	0	0	0	0	0	
Sample Date							5/6/2004	5/6/2004	5/6/2004	5/6/2004	5/6/2004	5/6/2004	
QC Code							SA	SA	SA	SA	SA	SA	
Study ID							ENSR IRM	ENSR IRM	ENSR IRM	ENSR IRM	ENSR IRM	ENSR IRM	
							1	1	1	1	1	1	
Parameter	Units	Maximum Value	Frequency of Detection	NYSDEC TAGM Level	Number of Exceedances	Number of Times Detected	Number of Sample Analyses	Value (Q)	Value (Q)	Value (Q)	Value (Q)	Value (Q)	
Chrysene	UG/KG	13000	100%	400	52	53	53	4400	5700	5000	2300	3200	5400
Di-n-butylphthalate	UG/KG	0	0%	8100	0	0	53	1900 U	3800 U	1900 U	1800 U	1900 U	1900 U
Di-n-octylphthalate	UG/KG	0	0%	50000	0	0	53	1900 U	3800 U	1900 U	1800 U	1900 U	1900 U
Dibenz(a,h)anthracene	UG/KG	2900	98%	14	52	52	53	1400 J	1500 J	1100 J	550 J	550 J	1100 J
Dibenzofuran	UG/KG	1300	62%	6200	0	33	53	1900 U	3800 U	490 J	1800 U	1900 U	380 J
Diethyl phthalate	UG/KG	0	0%	7100	0	0	53	1900 U	3800 U	1900 U	1800 U	1900 U	1900 U
Dimethylphthalate	UG/KG	0	0%	2000	0	0	53	1900 U	3800 U	1900 U	1800 U	1900 U	1900 U
Fluoranthene	UG/KG	29000	100%	50000	0	53	53	8900	9500	11000	4400	7500	11000
Fluorene	UG/KG	3100	89%	50000	0	47	53	500 J	560 J	1300 J	240 J	420 J	810 J
Hexachlorobenzene	UG/KG	0	0%	410	0	0	53	1900 U	3800 U	1900 U	1800 U	1900 U	1900 U
Hexachlorobutadiene	UG/KG	0	0%	0	0	0	53	1900 U	3800 U	1900 U	1800 U	1900 U	1900 U
Hexachlorocyclopentadiene	UG/KG	0	0%	0	0	0	5						
Hexachloroethane	UG/KG	0	0%	0	0	0	53	1900 U	3800 U	1900 U	1800 U	1900 U	1900 U
Indeno(1,2,3-cd)pyrene	UG/KG	8000	100%	3200	19	53	53	3600 J	4700 J	3000 J	1600 J	1600 J	2800 J
Isophorone	UG/KG	0	0%	4400	0	0	53	1900 U	3800 U	1900 U	1800 U	1900 U	1900 U
N-Nitrosodiphenylamine	UG/KG	0	0%	0	0	0	5						
N-Nitrosodipropylamine	UG/KG	0	0%	0	0	0	5						
Naphthalene	UG/KG	1200	62%	13000	0	33	53	240 NJ	3800 U	1000 J	1800 U	220 NJ	500 J
Nitrobenzene	UG/KG	0	0%	200	0	0	53	1900 U	3800 U	1900 U	1800 U	1900 U	1900 U
Pentachlorophenol	UG/KG	660	2%	1000	0	1	53	9700 U	19000 U	9900 U	9500 U	9900 U	9600 U
Phenanthrene	UG/KG	17000	100%	50000	0	53	53	4400	4900	7800	2200	4000	6000
Phenol	UG/KG	0	0%	30	0	0	53	1900 U	3800 U	1900 U	1800 U	1900 U	1900 U
Pyrene	UG/KG	22000	100%	50000	0	53	53	7400	8900	9800	3500	5600	9300
Pyridine	UG/KG	0	0%	0	0	0	48	9700 U	19000 U	9900 U	9500 U	9900 U	9600 U
Pesticides/PCBs													
4,4'-DDD	UG/KG	450	62%	2900	0	33	53	49	90	28	19	30	29
4,4'-DDE	UG/KG	230	62%	2100	0	33	53	100	230	28	22	52 J	35
4,4'-DDT	UG/KG	520	70%	2100	0	37	53	130	190	51	20	34	29
Aldrin	UG/KG	0	0%	41	0	0	53	9.7 U	9.7 U	10 U	9.5 U	9.9 U	9.6 U
Alpha-BHC	UG/KG	4.4	2%	110	0	1	53	9.7 U	9.7 U	10 U	9.5 U	9.9 U	9.6 U
Alpha-Chlordane	UG/KG	27	11%	0	0	6	53	9.7 U	9.7 U	10 U	9.5 U	9.9 U	9.6 U
Beta-BHC	UG/KG	13	2%	200	0	1	53	9.7 U	9.7 U	10 U	9.5 U	9.9 U	9.6 U
Delta-BHC	UG/KG	0	0%	300	0	0	53	9.7 U	9.7 U	10 U	9.5 U	9.9 U	9.6 U
Dieldrin	UG/KG	0	0%	44	0	0	53	19 U	19 U	19 U	18 U	19 U	19 U
Endosulfan I	UG/KG	0	0%	900	0	0	53	9.7 U	9.7 U	10 U	9.5 U	9.9 U	9.6 U
Endosulfan II	UG/KG	0	0%	900	0	0	53	19 U	19 U	19 U	18 U	19 U	19 U
Endosulfan sulfate	UG/KG	0	0%	1000	0	0	53	19 U	19 U	19 U	18 U	19 U	19 U
Endrin	UG/KG	0	0%	100	0	0	53	19 U	19 U	19 U	18 U	19 U	19 U
Endrin aldehyde	UG/KG	0	0%	0	0	0	53	19 U	19 U	19 U	18 U	19 U	19 U
Endrin ketone	UG/KG	15	2%	0	0	1	53	19 U	19 U	19 U	18 U	19 U	19 U

Table A-6
SOIL SAMPLE RESULTS
SEAD-59 STOCKPILE
SEAD-59 and SEAD-71 Phase II RI Report
Seneca Army Depot Activity

Facility	Location ID	SEAD-59	SEAD-59	SEAD-59	SEAD-59	SEAD-59	SEAD-59	SEAD-59	SEAD-59	SEAD-59			
Matrix	Sample ID	WS-59-01-006-7	WS-59-01-006-9	WS-59-01-007-1	WS-59-01-007-10	WS-59-01-007-11	WS-59-01-007-12	WS-59-01-006-7	WS-59-01-006-9	WS-59-01-007-1			
Sample Depth to Top of Sample	Sample Date	0	0	0	0	0	0	0	0	0			
Sample Depth to Bottom of Sample	QC Code	0	0	0	0	0	0	0	0	0			
Study ID	Study ID	5/6/2004	5/6/2004	5/6/2004	5/6/2004	5/6/2004	5/6/2004	SA	SA	SA			
Parameter	Units	ENSR IRM	ENSR IRM	ENSR IRM	ENSR IRM	ENSR IRM	ENSR IRM	ENSR IRM	ENSR IRM	ENSR IRM			
	Maximum Value	1	1	1	1	1	1	1	1	1			
	Frequency of Detection	Value (Q)	Value (Q)	Value (Q)	Value (Q)	Value (Q)	Value (Q)	Value (Q)	Value (Q)	Value (Q)			
	NYSDEC TAGM Level												
	Number of Exceedances												
	Number of Times Detected												
	Number of Sample Analyses												
Gamma-BHC/Lindane	UG/KG	0	0%	60	0	0	53	9.7 U	9.7 U	10 U	9.5 U	9.9 U	9.6 U
Gamma-Chlordane	UG/KG	21	9%	540	0	5	53	9.7 U	9.7 U	10 U	9.5 U	9.9 U	9.6 U
Heptachlor	UG/KG	0	0%	100	0	0	53	9.7 U	9.7 U	10 U	9.5 U	9.9 U	9.6 U
Heptachlor epoxide	UG/KG	0	0%	20	0	0	53	9.7 U	9.7 U	10 U	9.5 U	9.9 U	9.6 U
Methoxychlor	UG/KG	0	0%	0	0	0	53	97 U	97 U	99 U	95 U	99 U	96 U
Toxaphene	UG/KG	0	0%	0	0	0	53	190 U	190 U	190 U	180 U	190 U	190 U
Aroclor-1016	UG/KG	0	0%	0	0	0	53	38 U	38 U	39 U	37 U	38 U	37 U
Aroclor-1221	UG/KG	0	0%	0	0	0	53	38 U	38 U	39 U	37 U	38 U	37 U
Aroclor-1232	UG/KG	0	0%	0	0	0	53	38 U	38 U	39 U	37 U	38 U	37 U
Aroclor-1242	UG/KG	0	0%	0	0	0	53	38 U	38 U	39 U	37 U	38 U	37 U
Aroclor-1248	UG/KG	0	0%	0	0	0	53	38 U	38 U	39 U	37 U	38 U	37 U
Aroclor-1254	UG/KG	0	0%	10000	0	0	53	38 U	38 U	39 U	37 U	38 U	37 U
Aroclor-1260	UG/KG	0	0%	10000	0	0	53	38 U	38 U	39 U	37 U	38 U	37 U
Metals													
Aluminum	MG/KG	13400	100%	19300	0	53	53	10900	11400	10800	8340	8800	10400
Antimony	MG/KG	43.9	21%	5.9	3	11	53	3.3 UJ	3.4 UJ	3.4 UJ	3.2 UJ	3.4 UJ	3.3 UJ
Arsenic	MG/KG	7.3	100%	8.2	0	53	53	5.1 J	5.8 J	4.8 J	4.4	4.6	5.9
Barium	MG/KG	135	100%	300	0	53	53	88.6	90.8	98	74.7	69.7	81.4
Beryllium	MG/KG	0.69	100%	1.1	0	53	53	0.34	0.58	0.36	0.21	0.28	0.3
Cadmium	MG/KG	1.2	98%	2.3	0	52	53	0.73	0.76	0.62	0.7	0.64	0.72
Calcium	MG/KG	100000	100%	121000	0	53	53	46900	41200	41600	94200	64700	59200
Chromium	MG/KG	35	100%	29.6	3	53	53	22.5	21.3	19.4	21.4	17.7	18
Cobalt	MG/KG	13.9	100%	30	0	53	53	11.3	13.9	10.1	8.1	8.2	13.9
Copper	MG/KG	51.8	100%	33	14	53	53	32.5 J	43.6 J	37.4 J	27.3	25.9	36.2
Iron	MG/KG	26500	100%	36500	0	53	53	21300	21200	18800	16100	16500	20900
Lead	MG/KG	1440	100%	24.8	51	53	53	77	51.8	64.6	66.2 J	47.9 J	59.4 J
Magnesium	MG/KG	26600	100%	21500	1	53	53	7390	7690	7170	8830	9950	10200
Manganese	MG/KG	1220	100%	1060	2	53	53	547	476	479	438	419	453
Mercury	MG/KG	0.52	100%	0.1	9	53	53	0.07	0.08	0.04	0.1	0.07	0.05
Nickel	MG/KG	56.6	100%	49	1	53	53	33.8	36.1	28	26.5	26.3	56.6
Potassium	MG/KG	1580	100%	2380	0	53	53	1120	1200	1120	939	949	1090
Selenium	MG/KG	0.72	4%	2	0	2	53	0.55 U	0.57 U	0.56 U	0.53 U	0.56 UJ	0.55 UJ
Silver	MG/KG	4.7	17%	0.75	6	9	53	0.55 UJ	0.57 UJ	1.1 J	0.53 UJ	0.56 UJ	0.55 UJ
Sodium	MG/KG	525	100%	172	23	53	53	225	192 J	151 J	121	136	123
Thallium	MG/KG	0.99	51%	0.7	12	27	53	0.55 U	0.65 J	0.69 J	0.53 U	0.67 J	0.6 J
Vanadium	MG/KG	35.4	100%	150	0	53	53	19.5	19.9	18.9	35.4	23.2	20.8
Zinc	MG/KG	185	100%	110	6	53	53	106 J	185 J	84 J	90.8	87.4	78.6

Note(s):
(1) - NYSDEC Technical and Administrative Guidance Memorandum (TAGM) HWR-94-4046, Revised January 24, 1994
(2) - Sample-Duplicate pairs are presented as a combined sample in this table.
Their Sample ID is a combination of the sample and the sample duplicate Sample ID (for example FD-59-CL-05/CL-59-01-WS1)
In addition, the 'QC Code' field is labeled 'SADU'

U = compound was not detected
J = the reported value is an estimated concentration
UJ = the compound was not detected; the associated reporting limit is approximate
R = the data was rejected in the data validating process
NJ = compound was "tentatively identified" and the associated numerical value is approximate

**Table A-6
SOIL SAMPLE RESULTS
SEAD-59 STOCKPILE
SEAD-59 and SEAD-71 Phase II RI Report
Seneca Army Depot Activity**

Facility	SEAD-59	SEAD-59	SEAD-59	SEAD-59	SEAD-59	SEAD-59							
Location ID	WS-59-01-007-13	WS-59-01-007-14	WS-59-01-007-2	WS-59-01-007-5	WS-59-01-007-6	WS-59-01-007-8							
Matrix	SOIL	SOIL	SOIL	SOIL	SOIL	SOIL							
Sample ID	WS-59-01-007-13	WS-59-01-007-14	WS-59-01-007-2	WS-59-01-007-5	WS-59-01-007-6	WS-59-01-007-8							
Sample Depth to Top of Sample	0	0	0	0	0	0							
Sample Depth to Bottom of Sample	0	0	0	0	0	0							
Sample Date	5/6/2004	5/6/2004	5/6/2004	5/6/2004	5/6/2004	5/6/2004							
QC Code	SA	SA	SA	SA	SA	SA							
Study ID	ENSR IRM	ENSR IRM	ENSR IRM	ENSR IRM	ENSR IRM	ENSR IRM							
Parameter	Units	Maximum Value	Frequency of Detection	NYSDEC TAGM Level	Number of Exceedances	Number of Times Detected	Number of Sample Analyses	Value (Q)	Value (Q)	Value (Q)	Value (Q)	Value (Q)	Value (Q)
Volatile Organic Compounds													
1,1,1-Trichloroethane	UG/KG	0	0%	800	0	0	53	5.8 U	5.6 U	5.7 U	5.7 U	5.8 U	5.6 U
1,1,2,2-Tetrachloroethane	UG/KG	0	0%	600	0	0	52	5.8 U	5.6 U	5.7 U	5.7 U	5.8 U	5.6 U
1,1,2-Trichloro-1,2,2-Trifluoroethane	UG/KG	1.5	2%		0	1	53	5.8 U	5.6 U	5.7 U	5.7 U	5.8 U	5.6 U
1,1,2-Trichloroethane	UG/KG	0	0%		0	0	5						
1,1-Dichloroethane	UG/KG	0	0%	200	0	0	53	5.8 U	5.6 U	5.7 U	5.7 U	5.8 U	5.6 U
1,1-Dichloroethene	UG/KG	1	2%	400	0	1	53	5.8 U	5.6 U	5.7 U	5.7 U	5.8 U	5.6 U
1,2,3-Trichloropropane	UG/KG	0	0%		0	0	47	5.8 U	5.6 U	5.7 U	5.7 U	5.8 U	5.6 U
1,2,4-Trichlorobenzene	UG/KG	0	0%	3400	0	0	52	5.8 U	5.6 U	5.7 U	5.7 U	5.8 U	5.6 U
1,2-Dibromo-3-chloropropane	UG/KG	0	0%		0	0	5						
1,2-Dibromoethane	UG/KG	0	0%		0	0	5						
1,2-Dichlorobenzene	UG/KG	0	0%	7900	0	0	52	5.8 U	5.6 U	5.7 U	5.7 U	5.8 U	5.6 U
1,2-Dichloroethane	UG/KG	0	0%	100	0	0	53	5.8 U	5.6 U	5.7 U	5.7 U	5.8 U	5.6 U
1,2-Dichloropropane	UG/KG	0	0%		0	0	5						
1,3-Dichlorobenzene	UG/KG	0	0%	1600	0	0	52	5.8 U	5.6 U	5.7 U	5.7 U	5.8 U	5.6 U
1,3-Dichloropropane	UG/KG	0	0%		0	0	48	5.8 U	5.6 U	5.7 U	5.7 U	5.8 U	5.6 U
1,4-Dichlorobenzene	UG/KG	0	0%	8500	0	0	52	5.8 U	5.6 U	5.7 U	5.7 U	5.8 U	5.6 U
Acetone	UG/KG	69	25%	200	0	13	53	5.1 J	22 U	25	5.8 J	23 U	23 U
Benzene	UG/KG	0	0%	60	0	0	53	5.8 U	5.6 U	5.7 U	5.7 U	5.8 U	5.6 U
Bromodichloromethane	UG/KG	0	0%		0	0	5						
Bromoform	UG/KG	0	0%		0	0	5						
Carbon disulfide	UG/KG	0	0%	2700	0	0	53	5.8 U	5.6 U	5.7 U	5.7 U	5.8 U	5.6 U
Carbon tetrachloride	UG/KG	0	0%	600	0	0	53	5.8 U	5.6 U	5.7 U	5.7 U	5.8 U	5.6 U
Chlorobenzene	UG/KG	0	0%	1700	0	0	53	5.8 U	5.6 U	5.7 U	5.7 U	5.8 U	5.6 U
Chlorodibromomethane	UG/KG	0	0%		0	0	53	5.8 U	5.6 U	5.7 U	5.7 U	5.8 U	5.6 U
Chloroethane	UG/KG	0	0%	1900	0	0	53	12 U	11 U	11 U	11 U	12 U	11 U
Chloroform	UG/KG	0	0%	300	0	0	53	5.8 U	5.6 U	5.7 U	5.7 U	5.8 U	5.6 U
Cis-1,2-Dichloroethene	UG/KG	0	0%		0	0	5						
Cis-1,3-Dichloropropene	UG/KG	0	0%		0	0	5						
Cyclohexane	UG/KG	0	0%		0	0	5						
Dichlorodifluoromethane	UG/KG	0	0%		0	0	5						
Ethyl benzene	UG/KG	0	0%	5500	0	0	53	5.8 U	5.6 U	5.7 U	5.7 U	5.8 U	5.6 U
Isopropylbenzene	UG/KG	0	0%		0	0	5						
Meta/Para Xylene	UG/KG	2.3	4%		0	2	48	2.3 J	5.6 U	5.7 U	5.7 U	5.8 U	5.6 U
Methyl Acetate	UG/KG	0	0%		0	0	5						
Methyl Tertbutyl Ether	UG/KG	0	0%		0	0	5						
Methyl bromide	UG/KG	0	0%		0	0	5						
Methyl butyl ketone	UG/KG	0	0%		0	0	5						
Methyl chloride	UG/KG	0	0%		0	0	5						
Methyl cyclohexane	UG/KG	0	0%		0	0	5						
Methyl ethyl ketone	UG/KG	7	9%	300	0	5	53	2.6 J	11 U	11 U	11 U	12 U	11 U
Methyl isobutyl ketone	UG/KG	0	0%	1000	0	0	53	12 U	11 U	11 U	11 U	12 U	11 U
Methylene chloride	UG/KG	3.45	2%	100	0	1	53	5.8 U	5.6 U	5.7 U	5.7 U	5.8 U	5.6 U
Ortho Xylene	UG/KG	1.9	10%		0	5	48	1.6 J	1 J	5.7 U	5.7 U	5.8 U	1.4 J
Styrene	UG/KG	0	0%		0	0	5						
Tetrachloroethene	UG/KG	6.7	6%	1400	0	3	53	5.8 U	5.6 U	5.7 U	5.7 U	5.8 U	5.6 U
Toluene	UG/KG	0	0%	1500	0	0	53	5.8 U	5.6 U	5.7 U	5.7 U	5.8 U	5.6 U
Total Xylenes	UG/KG	3	20%	1200	0	1	5						
Trans-1,2-Dichloroethene	UG/KG	0	0%	300	0	0	53	5.8 U	5.6 U	5.7 U	5.7 U	5.8 U	5.6 U

**Table A-6
SOIL SAMPLE RESULTS
SEAD-59 STOCKPILE
SEAD-59 and SEAD-71 Phase II RI Report
Seneca Army Depot Activity**

Facility	SEAD-59	SEAD-59	SEAD-59	SEAD-59	SEAD-59	SEAD-59							
Location ID	WS-59-01-007-13	WS-59-01-007-14	WS-59-01-007-2	WS-59-01-007-5	WS-59-01-007-6	WS-59-01-007-8							
Matrix	SOIL	SOIL	SOIL	SOIL	SOIL	SOIL							
Sample ID	WS-59-01-007-13	WS-59-01-007-14	WS-59-01-007-2	WS-59-01-007-5	WS-59-01-007-6	WS-59-01-007-8							
Sample Depth to Top of Sample	0	0	0	0	0	0							
Sample Depth to Bottom of Sample	0	0	0	0	0	0							
Sample Date	5/6/2004	5/6/2004	5/6/2004	5/6/2004	5/6/2004	5/6/2004							
QC Code	SA	SA	SA	SA	SA	SA							
Study ID	ENSR IRM	ENSR IRM	ENSR IRM	ENSR IRM	ENSR IRM	ENSR IRM							
	1	1	1	1	1	1							
Parameter	Units	Maximum Value	Frequency of Detection	NYSDEC TAGM Level	Number of Exceedances	Number of Times Detected	Number of Sample Analyses	Value (Q)	Value (Q)	Value (Q)	Value (Q)	Value (Q)	Value (Q)
Trans-1,3-Dichloropropene	UG/KG	0	0%		0	0	5						
Trichloroethene	UG/KG	4.2	8%	700	0	4	53	5.8 U	5.6 U	5.7 U	5.7 U	5.8 U	1.4 J
Trichlorofluoromethane	UG/KG	0	0%		0	0	5						
Vinyl chloride	UG/KG	0	0%	200	0	0	53	12 U	11 U	11 U	11 U	12 U	11 U
Semivolatile Organics Compounds													
1,1'-Biphenyl	UG/KG	59	20%		0	1	5						
2,2'-oxybis(1-Chloropropane)	UG/KG	0	0%		0	0	5						
2,4,5-Trichlorophenol	UG/KG	0	0%	100	0	0	53	1900 U	3700 U	1900 U	1900 U	1900 U	3700 U
2,4,6-Trichlorophenol	UG/KG	0	0%		0	0	53	1900 U	3700 U	1900 U	1900 U	1900 U	3700 U
2,4-Dichlorophenol	UG/KG	0	0%	400	0	0	53	1900 U	3700 U	1900 U	1900 U	1900 U	3700 U
2,4-Dimethylphenol	UG/KG	0	0%		0	0	5						
2,4-Dinitrophenol	UG/KG	0	0%	200	0	0	53	9900 U	19000 U	9700 UJ	9700 U	9900 U	19000 U
2,4-Dinitrotoluene	UG/KG	0	0%		0	0	53	1900 U	3700 U	1900 U	1900 U	1900 U	3700 U
2,6-Dinitrotoluene	UG/KG	0	0%	1000	0	0	53	1900 U	3700 U	1900 U	1900 U	1900 U	3700 U
2-Chloronaphthalene	UG/KG	0	0%		0	0	5						
2-Chlorophenol	UG/KG	0	0%	800	0	0	53	1900 U	3700 U	1900 U	1900 U	1900 U	3700 U
2-Methylnaphthalene	UG/KG	1200	51%	36400	0	27	53	860 J	600 J	240 J	1900 U	1900 U	3700 U
2-Methylphenol	UG/KG	0	0%	100	0	0	53	1900 U	3700 U	1900 U	1900 U	1900 U	3700 U
2-Nitroaniline	UG/KG	0	0%	430	0	0	53	9900 U	19000 U	9700 U	9700 U	9900 U	19000 U
2-Nitrophenol	UG/KG	0	0%	330	0	0	53	1900 U	3700 U	1900 U	1900 U	1900 U	3700 U
3,3'-Dichlorobenzidine	UG/KG	0	0%		0	0	53	1900 U	3700 U	1900 U	1900 U	1900 U	3700 U
3-Nitroaniline	UG/KG	0	0%	500	0	0	53	9900 U	19000 U	9700 U	9700 U	9900 U	19000 U
4,6-Dinitro-2-methylphenol	UG/KG	0	0%		0	0	5						
4-Bromophenyl phenyl ether	UG/KG	0	0%		0	0	5						
4-Chloro-3-methylphenol	UG/KG	0	0%	240	0	0	53	1900 U	3700 U	1900 U	1900 U	1900 U	3700 U
4-Chloroaniline	UG/KG	0	0%	220	0	0	53	1900 U	3700 U	1900 U	1900 U	1900 U	3700 U
4-Chlorophenyl phenyl ether	UG/KG	0	0%		0	0	5						
4-Methylphenol	UG/KG	0	0%	900	0	0	53	1900 U	3700 U	1900 U	1900 U	1900 U	3700 U
4-Nitroaniline	UG/KG	0	0%		0	0	5						
4-Nitrophenol	UG/KG	0	0%	100	0	0	53	9900 U	19000 U	9700 U	9700 U	9900 U	19000 U
Acenaphthene	UG/KG	2400	87%	50000	0	46	53	780 J	1500 J	340 J	370 J	410 J	780 J
Acenaphthylene	UG/KG	3500	98%	41000	0	52	53	1600 J	3500 J	1100 J	1500 J	1200 J	3000 J
Acetophenone	UG/KG	0	0%		0	0	5						
Aniline	UG/KG	0	0%		0	0	48	1900 U	3700 U	1900 U	1900 U	1900 U	3700 U
Anthracene	UG/KG	6600	100%	50000	0	53	53	2200	6600	1400 J	1300 J	1600 J	3100 J
Atrazine	UG/KG	0	0%		0	0	5						
Benzaldehyde	UG/KG	0	0%		0	0	5						
Benzo(a)anthracene	UG/KG	14000	100%	224	52	53	53	3800	13000	4300	3600	3400	6900
Benzo(a)pyrene	UG/KG	16000	100%	61	53	53	53	4300	14000	4600	4400	3600	8200
Benzo(b)fluoranthene	UG/KG	11000	100%	1100	46	53	53	2900	9800	3300	3200	2800	5800
Benzo(ghi)perylene	UG/KG	8000	100%	50000	0	53	53	2100	6800	2600	3000	2000	4200
Benzo(k)fluoranthene	UG/KG	13000	100%	1100	46	53	53	3200	11000	3400	3400	2700	6300
Benzoic Acid	UG/KG	0	0%	2700	0	0	48	9900 U	19000 U	9700 U	9700 U	9900 U	19000 U
Bis(2-Chloroethoxy)methane	UG/KG	0	0%		0	0	5						
Bis(2-Chloroethyl)ether	UG/KG	0	0%		0	0	5						
Bis(2-Ethylhexyl)phthalate	UG/KG	130	6%	50000	0	3	53	1900 U	3700 U	1900 U	1900 U	1900 U	3700 U
Butylbenzylphthalate	UG/KG	0	0%	50000	0	0	53	1900 UJ	3700 UJ	1900 U	1900 U	1900 UJ	3700 UJ
Caprolactam	UG/KG	0	0%		0	0	5						
Carbazole	UG/KG	1100	80%		0	4	5						

Table A-6
SOIL SAMPLE RESULTS
SEAD-59 STOCKPILE
SEAD-59 and SEAD-71 Phase II RI Report
Seneca Army Depot Activity

Facility	Location ID	Matrix	Sample ID	Sample Depth to Top of Sample	Sample Depth to Bottom of Sample	Sample Date	QC Code	Study ID	SEAD-59 WS-59-01-007-13	SEAD-59 WS-59-01-007-14	SEAD-59 WS-59-01-007-2	SEAD-59 WS-59-01-007-5	SEAD-59 WS-59-01-007-6	SEAD-59 WS-59-01-007-8	
Parameter	Units	Maximum Value	Frequency of Detection	NYSDEC TAGM Level	Number of Exceedances	Number of Times Detected	Number of Sample Analyses		Value (Q)	Value (Q)	Value (Q)	Value (Q)	Value (Q)	Value (Q)	
Chrysene	UG/KG	13000	100%	400	52	53	53		3800	13000	4200	3600	3300	7000	
Di-n-butylphthalate	UG/KG	0	0%	8100	0	0	53		1900 U	3700 U	1900 U	1900 U	1900 U	3700 U	
Di-n-octylphthalate	UG/KG	0	0%	50000	0	0	53		1900 U	3700 U	1900 U	1900 U	1900 U	3700 U	
Dibenz(a,h)anthracene	UG/KG	2900	98%	14	52	52	53		780 J	2500 J	870 J	940 J	740 J	1600 J	
Dibenzofuran	UG/KG	1300	62%	6200	0	33	53		630 J	900 J	190 J	200 J	270 J	460 J	
Diethyl phthalate	UG/KG	0	0%	7100	0	0	53		1900 U	3700 U	1900 U	1900 U	1900 U	3700 U	
Dimethylphthalate	UG/KG	0	0%	2000	0	0	53		1900 U	3700 U	1900 U	1900 U	1900 U	3700 U	
Fluoranthene	UG/KG	29000	100%	50000	0	53	53		8100	29000	7600	7000	7200	14000	
Fluorene	UG/KG	3100	89%	50000	0	47	53		1400 J	2300 J	470 J	460 J	730 J	1100 J	
Hexachlorobenzene	UG/KG	0	0%	410	0	0	53		1900 U	3700 U	1900 U	1900 U	1900 U	3700 U	
Hexachlorobutadiene	UG/KG	0	0%	0	0	0	53		1900 U	3700 U	1900 U	1900 U	1900 U	3700 U	
Hexachlorocyclopentadiene	UG/KG	0	0%	0	0	0	5								
Hexachloroethane	UG/KG	0	0%	0	0	0	53		1900 U	3700 U	1900 U	1900 U	1900 U	3700 U	
Indeno(1,2,3-cd)pyrene	UG/KG	8000	100%	3200	19	53	53		2000 J	7000 J	2500 J	2600 J	2000 J	4100 J	
Isophorone	UG/KG	0	0%	4400	0	0	53		1900 U	3700 U	1900 U	1900 U	1900 U	3700 U	
N-Nitrosodiphenylamine	UG/KG	0	0%	0	0	0	5								
N-Nitrosodipropylamine	UG/KG	0	0%	0	0	0	5								
Naphthalene	UG/KG	1200	62%	13000	0	33	53		1200 J	880 J	260 J	200 J	1900 U	440 NJ	
Nitrobenzene	UG/KG	0	0%	200	0	0	53		1900 U	3700 U	1900 U	1900 U	1900 U	3700 U	
Pentachlorophenol	UG/KG	660	2%	1000	0	1	53		9900 U	19000 U	9700 U	9700 U	9900 U	19000 U	
Phenanthrene	UG/KG	17000	100%	50000	0	53	53		6400	17000	3000	3600	4800	7700	
Phenol	UG/KG	0	0%	30	0	0	53		1900 U	3700 U	1900 U	1900 U	1900 U	3700 U	
Pyrene	UG/KG	22000	100%	50000	0	53	53		6300	19000	6500	7100	6100	11000	
Pyridine	UG/KG	0	0%	0	0	0	48		9900 U	19000 U	9700 U	9700 U	9900 U	19000 U	
Pesticides/PCBs															
4,4'-DDD	UG/KG	450	62%	2900	0	33	53		65	27	19 U	53	26	21	
4,4'-DDE	UG/KG	230	62%	2100	0	33	53		96 J	47	50	47	42 J	29	
4,4'-DDT	UG/KG	520	70%	2100	0	37	53		95	59	52	32	43	43	
Aldrin	UG/KG	0	0%	41	0	0	53		9.9 U	9.5 U	9.7 U	9.7 U	10 U	9.6 U	
Alpha-BHC	UG/KG	4.4	2%	110	0	1	53		9.9 U	9.5 U	9.7 U	9.7 U	10 U	9.6 U	
Alpha-Chlordane	UG/KG	27	11%	0	0	6	53		9.9 U	9.5 U	9.7 U	9.7 U	10 U	9.6 U	
Beta-BHC	UG/KG	13	2%	200	0	1	53		9.9 U	9.5 U	9.7 U	9.7 U	10 U	9.6 U	
Delta-BHC	UG/KG	0	0%	300	0	0	53		9.9 U	9.5 U	9.7 U	9.7 U	10 U	9.6 U	
Dieldrin	UG/KG	0	0%	44	0	0	53		19 U	18 U	19 U	19 U	19 U	19 U	
Endosulfan I	UG/KG	0	0%	900	0	0	53		9.9 U	9.5 U	9.7 U	9.7 U	10 U	9.6 U	
Endosulfan II	UG/KG	0	0%	900	0	0	53		19 U	18 U	19 U	19 U	19 U	19 U	
Endosulfan sulfate	UG/KG	0	0%	1000	0	0	53		19 U	18 U	19 U	19 U	19 U	19 U	
Endrin	UG/KG	0	0%	100	0	0	53		19 U	18 U	19 U	19 U	19 U	19 U	
Endrin aldehyde	UG/KG	0	0%	0	0	0	53		19 U	18 U	19 U	19 U	19 U	19 U	
Endrin ketone	UG/KG	15	2%	0	0	1	53		19 U	18 U	19 U	19 U	19 U	19 U	

Table A-6
SOIL SAMPLE RESULTS
SEAD-59 STOCKPILE
SEAD-59 and SEAD-71 Phase II RI Report
Seneca Army Depot Activity

Facility	Location ID	Matrix	Sample ID	Sample Depth to Top of Sample	Sample Depth to Bottom of Sample	Sample Date	QC Code	Study ID	SEAD-59	SEAD-59	SEAD-59	SEAD-59	SEAD-59	SEAD-59
									WS-59-01-007-13	WS-59-01-007-14	WS-59-01-007-2	WS-59-01-007-5	WS-59-01-007-6	WS-59-01-007-8
Parameter	Units	Maximum Value	Frequency of Detection	NYSDEC TAGM Level	Number of Exceedances	Number of Times Detected	Number of Sample Analyses	ENSR IRM	ENSR IRM	ENSR IRM	ENSR IRM	ENSR IRM	ENSR IRM	
								1	1	1	1	1	1	
								Value (Q)	Value (Q)	Value (Q)	Value (Q)	Value (Q)	Value (Q)	
Gamma-BHC/Lindane	UG/KG	0	0%	60	0	0	53	9.9 U	9.5 U	9.7 U	9.7 U	10 U	9.6 U	
Gamma-Chlordane	UG/KG	21	9%	540	0	5	53	9.9 U	9.5 U	9.7 U	9.7 U	10 U	9.6 U	
Heptachlor	UG/KG	0	0%	100	0	0	53	9.9 U	9.5 U	9.7 U	9.7 U	10 U	9.6 U	
Heptachlor epoxide	UG/KG	0	0%	20	0	0	53	9.9 U	9.5 U	9.7 U	9.7 U	10 U	9.6 U	
Methoxychlor	UG/KG	0	0%		0	0	53	99 U	95 U	97 U	97 U	99 U	96 U	
Toxaphene	UG/KG	0	0%		0	0	53	190 U	180 U	190 U	190 U	190 U	190 U	
Aroclor-1016	UG/KG	0	0%		0	0	53	38 U	37 U	38 U	38 U	38 U	37 U	
Aroclor-1221	UG/KG	0	0%		0	0	53	38 U	37 U	38 U	38 U	38 U	37 U	
Aroclor-1232	UG/KG	0	0%		0	0	53	38 U	37 U	38 U	38 U	38 U	37 U	
Aroclor-1242	UG/KG	0	0%		0	0	53	38 U	37 U	38 U	38 U	38 U	37 U	
Aroclor-1248	UG/KG	0	0%		0	0	53	38 U	37 U	38 U	38 U	38 U	37 U	
Aroclor-1254	UG/KG	0	0%	10000	0	0	53	38 U	37 U	38 U	38 U	38 U	37 U	
Aroclor-1260	UG/KG	0	0%	10000	0	0	53	38 U	37 U	38 U	38 U	38 U	37 U	
Metals														
Aluminum	MG/KG	13400	100%	19300	0	53	53	11000	10700	11300	10700	10900	9580	
Antimony	MG/KG	43.9	21%	5.9	3	11	53	3.5 UJ	3.3 UJ	3.4 UJ	3.3 UJ	3.4 UJ	3.2 UJ	
Arsenic	MG/KG	7.3	100%	8.2	0	53	53	5	4.6	5 J	4.5	4.9	4.8	
Barium	MG/KG	135	100%	300	0	53	53	87.8	78.5	89.6	84.9	95.4	81.5	
Beryllium	MG/KG	0.69	100%	1.1	0	53	53	0.4	0.38	0.38	0.28	0.32	0.27	
Cadmium	MG/KG	1.2	98%	2.3	0	52	53	0.72	0.72	0.66	0.76	0.64	0.66	
Calcium	MG/KG	100000	100%	121000	0	53	53	39800	54000	33400	53300	36800	82600	
Chromium	MG/KG	35	100%	29.6	3	53	53	19.2	19.6	31.8	19.9	18.7	17.6	
Cobalt	MG/KG	13.9	100%	30	0	53	53	11.5	11	11.5	10.4	9.7	10.8	
Copper	MG/KG	51.8	100%	33	14	53	53	38.3	30.8	31.4 J	28.2	33.9	26.9	
Iron	MG/KG	26500	100%	36500	0	53	53	21200	20900	20300	19300	19800	18200	
Lead	MG/KG	1440	100%	24.8	51	53	53	45.5 J	32.7 J	42.9	77.5 J	38.8 J	37.4 J	
Magnesium	MG/KG	26600	100%	21500	1	53	53	7750	10200	7020	8370	9510	10300	
Manganese	MG/KG	1220	100%	1060	2	53	53	499	510	474	475	459	560	
Mercury	MG/KG	0.52	100%	0.1	9	53	53	0.07	0.04	0.08	0.05	0.05	0.06	
Nickel	MG/KG	56.6	100%	49	1	53	53	31.2	33.3	31.7	33.2	27.9	28.7	
Potassium	MG/KG	1580	100%	2380	0	53	53	1110	1120	1150	1090	1080	1080	
Selenium	MG/KG	0.72	4%	2	0	2	53	0.58 UJ	0.69 J	0.56 U	0.56 U	0.57 U	0.54 UJ	
Silver	MG/KG	4.7	17%	0.75	6	9	53	0.58 UJ	0.55 UJ	0.85 J	0.56 UJ	0.57 UJ	0.54 UJ	
Sodium	MG/KG	525	100%	172	23	53	53	118	106	237 J	115	110	128	
Thallium	MG/KG	0.99	51%	0.7	12	27	53	0.58 U	0.6 J	0.56 U	0.56 U	0.57 U	0.59 J	
Vanadium	MG/KG	35.4	100%	150	0	53	53	21.2	18.6	19.4	20.2	21.1	18.7	
Zinc	MG/KG	185	100%	110	6	53	53	98.1	85.5	113 J	88.9	88.5	77.9	

Note(s):
(1) - NYSDEC Technical and Administrative Guidance Memorandum (TAGM) HWR-94-4046, Revised January 24, 1994
(2) - Sample-Duplicate pairs are presented as a combined sample in this table.
Their Sample ID is a combination of the sample and the sample duplicate Sample ID (for example FD-59-CL-05/CL-59-01-WS1)
In addition, the 'QC Code' field is labeled 'SADU'

U = compound was not detected
J = the reported value is an estimated concentration
UJ = the compound was not detected; the associated reporting limit is approximate
R = the data was rejected in the data validating process
NJ = compound was "tentatively identified" and the associated numerical value is approximate

Table A-6
SOIL SAMPLE RESULTS
SEAD-59 STOCKPILE
SEAD-59 and SEAD-71 Phase II RI Report
Seneca Army Depot Activity

Facility	SEAD-59	SEAD-59	SEAD-59	SEAD-59	SEAD-59	SEAD-59							
Location ID	WS-59-01-008-1	WS-59-01-008-2	WS-59-01-008-3	WS-59-01-011-1	WS-59-01-011-2	WS-59-01-011-5							
Matrix	SOIL	SOIL	SOIL	SOIL	SOIL	SOIL							
Sample ID	WS-59-01-008-1	WS-59-01-008-2	WS-59-01-008-3	WS-59-01-011-1	WS-59-01-011-2	WS-59-01-011-5							
Sample Depth to Top of Sample	0	0	0	0	0	0							
Sample Depth to Bottom of Sample	0	0	0	0	0	0							
Sample Date	5/6/2004	5/6/2004	5/6/2004	5/6/2004	5/6/2004	5/6/2004							
QC Code	SA	SA	SA	SA	SA	SA							
Study ID	ENSR IRM	ENSR IRM	ENSR IRM	ENSR IRM	ENSR IRM	ENSR IRM							
	1	1	1	1	1	1							
Parameter	Units	Maximum Value	Frequency of Detection	NYSDEC TAGM Level	Number of Exceedances	Number of Times Detected	Number of Sample Analyses	Value (Q)	Value (Q)	Value (Q)	Value (Q)	Value (Q)	Value (Q)
Volatile Organic Compounds													
1,1,1-Trichloroethane	UG/KG	0	0%	800	0	0	53	5.9 U	5.6 U	5.8 U	5 U	6 UJ	5.7 U
1,1,2,2-Tetrachloroethane	UG/KG	0	0%	600	0	0	52	5.9 U	5.6 U	5.8 U	5 U	6 UJ	5.7 U
1,1,2-Trichloro-1,2,2-Trifluoroethane	UG/KG	1.5	2%		0	1	53	5.9 U	5.6 U	5.8 U	5 UJ	6 UJ	5.7 U
1,1,2-Trichloroethane	UG/KG	0	0%		0	0	5				5 U	6 UJ	
1,1-Dichloroethane	UG/KG	0	0%	200	0	0	53	5.9 U	5.6 U	5.8 U	5 U	6 UJ	5.7 U
1,1-Dichloroethene	UG/KG	1	2%	400	0	1	53	5.9 U	5.6 U	5.8 U	1 J	6 UJ	5.7 U
1,2,3-Trichloropropane	UG/KG	0	0%		0	0	47	5.9 U	5.6 U	5.8 U			5.7 U
1,2,4-Trichlorobenzene	UG/KG	0	0%	3400	0	0	52	5.9 U	5.6 U	5.8 U	5 U	6 UJ	5.7 U
1,2-Dibromo-3-chloropropane	UG/KG	0	0%		0	0	5				5 U	6 UJ	
1,2-Dibromoethane	UG/KG	0	0%		0	0	5				5 U	6 UJ	
1,2-Dichlorobenzene	UG/KG	0	0%	7900	0	0	52	5.9 U	5.6 U	5.8 U	5 U	6 UJ	5.7 U
1,2-Dichloroethane	UG/KG	0	0%	100	0	0	53	5.9 U	5.6 U	5.8 U	5 U	6 UJ	5.7 U
1,2-Dichloropropane	UG/KG	0	0%		0	0	5				5 U	6 UJ	
1,3-Dichlorobenzene	UG/KG	0	0%	1600	0	0	52	5.9 U	5.6 U	5.8 U	5 U	6 UJ	5.7 U
1,3-Dichloropropane	UG/KG	0	0%		0	0	48	5.9 U	5.6 U	5.8 U			5.7 U
1,4-Dichlorobenzene	UG/KG	0	0%	8500	0	0	52	5.9 U	5.6 U	5.8 U	5 U	6 UJ	5.7 U
Acetone	UG/KG	69	25%	200	0	13	53	24 U	22 U	23 U	5 U	6 UJ	23 U
Benzene	UG/KG	0	0%	60	0	0	53	5.9 U	5.6 U	5.8 U	5 U	6 UJ	5.7 U
Bromodichloromethane	UG/KG	0	0%		0	0	5				5 U	6 UJ	
Bromoform	UG/KG	0	0%		0	0	5				5 U	6 UJ	
Carbon disulfide	UG/KG	0	0%	2700	0	0	53	5.9 U	5.6 U	5.8 U	5 U	6 UJ	5.7 U
Carbon tetrachloride	UG/KG	0	0%	600	0	0	53	5.9 U	5.6 U	5.8 U	5 U	6 UJ	5.7 U
Chlorobenzene	UG/KG	0	0%	1700	0	0	53	5.9 U	5.6 U	5.8 U	5 U	6 UJ	5.7 U
Chlorodibromomethane	UG/KG	0	0%		0	0	53	5.9 U	5.6 U	5.8 U	5 U	6 UJ	5.7 U
Chloroethane	UG/KG	0	0%	1900	0	0	53	12 U	11 U	12 U	5 U	6 UJ	11 U
Chloroform	UG/KG	0	0%	300	0	0	53	5.9 U	5.6 U	5.8 U	5 U	6 UJ	5.7 U
Cis-1,2-Dichloroethene	UG/KG	0	0%		0	0	5				5 U	6 UJ	
Cis-1,3-Dichloropropene	UG/KG	0	0%		0	0	5				5 U	6 UJ	
Cyclohexane	UG/KG	0	0%		0	0	5				5 U	6 UJ	
Dichlorodifluoromethane	UG/KG	0	0%		0	0	5				5 U	6 UJ	
Ethyl benzene	UG/KG	0	0%	5500	0	0	53	5.9 U	5.6 U	5.8 U	5 U	6 UJ	5.7 U
Isopropylbenzene	UG/KG	0	0%		0	0	5				5 U	6 UJ	
Meta/Para Xylene	UG/KG	2.3	4%		0	2	48	5.9 U	5.6 U	5.8 U			5.7 U
Methyl Acetate	UG/KG	0	0%		0	0	5				5 U	6 UJ	
Methyl Tertbutyl Ether	UG/KG	0	0%		0	0	5				5 U	6 UJ	
Methyl bromide	UG/KG	0	0%		0	0	5				5 U	6 UJ	
Methyl butyl ketone	UG/KG	0	0%		0	0	5				5 U	6 UJ	
Methyl chloride	UG/KG	0	0%		0	0	5				5 U	6 UJ	
Methyl cyclohexane	UG/KG	0	0%		0	0	5				5 U	6 UJ	
Methyl ethyl ketone	UG/KG	7	9%	300	0	5	53	12 U	11 U	12 U	5 U	6 UJ	11 U
Methyl isobutyl ketone	UG/KG	0	0%	1000	0	0	53	12 U	11 U	12 U	5 U	6 UJ	11 U
Methylene chloride	UG/KG	3.45	2%	100	0	1	53	5.9 U	5.6 U	5.8 U	5 U	6 UJ	5.7 U
Ortho Xylene	UG/KG	1.9	10%		0	5	48	1.7 J	5.6 U	5.8 U			5.7 U
Styrene	UG/KG	0	0%		0	0	5				5 U	6 UJ	
Tetrachloroethene	UG/KG	6.7	6%	1400	0	3	53	5.9 U	5.6 U	5.8 U	5 U	6 UJ	5.7 U
Toluene	UG/KG	0	0%	1500	0	0	53	5.9 U	5.6 U	5.8 U	5 U	6 UJ	5.7 U
Total Xylenes	UG/KG	3	20%	1200	0	1	5				3 J	6 UJ	
Trans-1,2-Dichloroethene	UG/KG	0	0%	300	0	0	53	5.9 U	5.6 U	5.8 U	5 U	6 UJ	5.7 U

**Table A-6
SOIL SAMPLE RESULTS
SEAD-59 STOCKPILE
SEAD-59 and SEAD-71 Phase II RI Report
Seneca Army Depot Activity**

Facility	SEAD-59	SEAD-59	SEAD-59	SEAD-59	SEAD-59	SEAD-59							
Location ID	WS-59-01-008-1	WS-59-01-008-2	WS-59-01-008-3	WS-59-01-011-1	WS-59-01-011-2	WS-59-01-011-5							
Matrix	SOIL	SOIL	SOIL	SOIL	SOIL	SOIL							
Sample ID	WS-59-01-008-1	WS-59-01-008-2	WS-59-01-008-3	WS-59-01-011-1	WS-59-01-011-2	WS-59-01-011-5							
Sample Depth to Top of Sample	0	0	0	0	0	0							
Sample Depth to Bottom of Sample	0	0	0	0	0	0							
Sample Date	5/6/2004	5/6/2004	5/6/2004	5/6/2004	5/6/2004	5/6/2004							
QC Code	SA	SA	SA	SA	SA	SA							
Study ID	ENSR IRM	ENSR IRM	ENSR IRM	ENSR IRM	ENSR IRM	ENSR IRM							
	1	1	1	1	1	1							
Parameter	Units	Maximum Value	Frequency of Detection	NYSDEC TAGM Level	Number of Exceedances	Number of Times Detected	Number of Sample Analyses	Value (Q)	Value (Q)	Value (Q)	Value (Q)	Value (Q)	Value (Q)
Trans-1,3-Dichloropropene	UG/KG	0	0%		0	0	5					5 U	
Trichloroethene	UG/KG	4.2	8%	700	0	4	53	5.9 U	5.6 U	5.8 U	5 U	6 UJ	5.7 U
Trichlorofluoromethane	UG/KG	0	0%		0	0	5				5 U	6 UJ	
Vinyl chloride	UG/KG	0	0%	200	0	0	53	12 U	11 U	12 U	5 U	6 UJ	11 U
Semivolatile Organics Compounds													
1,1'-Biphenyl	UG/KG	59	20%		0	1	5				1800 U	1900 U	
2,2'-oxybis(1-Chloropropane)	UG/KG	0	0%		0	0	5				1800 U	1900 U	
2,4,5-Trichlorophenol	UG/KG	0	0%	100	0	0	53	2000 U	3700 U	1900 U	4500 U	4700 U	750 U
2,4,6-Trichlorophenol	UG/KG	0	0%		0	0	53	2000 U	3700 U	1900 U	1800 U	1900 U	750 U
2,4-Dichlorophenol	UG/KG	0	0%	400	0	0	53	2000 U	3700 U	1900 U	1800 U	1900 U	750 U
2,4-Dimethylphenol	UG/KG	0	0%		0	0	5				1800 U	1900 U	
2,4-Dinitrophenol	UG/KG	0	0%	200	0	0	53	10000 U	19000 U	9900 U	4500 U	4700 U	3900 U
2,4-Dinitrotoluene	UG/KG	0	0%		0	0	53	2000 U	3700 U	1900 U	1800 U	1900 U	750 U
2,6-Dinitrotoluene	UG/KG	0	0%	1000	0	0	53	2000 U	3700 U	1900 U	1800 U	1900 U	750 U
2-Chloronaphthalene	UG/KG	0	0%		0	0	5				1800 U	1900 U	
2-Chlorophenol	UG/KG	0	0%	800	0	0	53	2000 U	3700 U	1900 U	1800 U	1900 U	750 U
2-Methylnaphthalene	UG/KG	1200	51%	36400	0	27	53	610 J	3700 U	570 J	940 J	240 J	750 U
2-Methylphenol	UG/KG	0	0%	100	0	0	53	2000 U	3700 U	1900 U	1800 U	1900 U	750 U
2-Nitroaniline	UG/KG	0	0%	430	0	0	53	10000 U	19000 U	9900 U	4500 U	4700 U	3900 U
2-Nitrophenol	UG/KG	0	0%	330	0	0	53	2000 U	3700 U	1900 U	1800 U	1900 U	750 U
3,3'-Dichlorobenzidine	UG/KG	0	0%		0	0	53	2000 U	3700 U	1900 U	1800 U	1900 U	750 U
3-Nitroaniline	UG/KG	0	0%	500	0	0	53	10000 U	19000 U	9900 U	4500 U	4700 U	3900 U
4,6-Dinitro-2-methylphenol	UG/KG	0	0%		0	0	5				4500 U	4700 U	
4-Bromophenyl phenyl ether	UG/KG	0	0%		0	0	5				1800 U	1900 U	
4-Chloro-3-methylphenol	UG/KG	0	0%	240	0	0	53	2000 U	3700 U	1900 U	1800 U	1900 U	750 U
4-Chloroaniline	UG/KG	0	0%	220	0	0	53	2000 U	3700 U	1900 U	1800 U	1900 U	750 U
4-Chlorophenyl phenyl ether	UG/KG	0	0%		0	0	5				1800 U	1900 U	
4-Methylphenol	UG/KG	0	0%	900	0	0	53	2000 U	3700 U	1900 U	1800 U	1900 U	750 U
4-Nitroaniline	UG/KG	0	0%		0	0	5				4500 U	4700 U	
4-Nitrophenol	UG/KG	0	0%	100	0	0	53	10000 U	19000 U	9900 U	4500 U	4700 U	3900 U
Acenaphthene	UG/KG	2400	87%	50000	0	46	53	630 J	530 J	660 J	1200 J	420 J	120 J
Acenaphthylene	UG/KG	3500	98%	41000	0	52	53	1500 J	2700 J	2200	1600 J	1400 J	620 J
Acetophenone	UG/KG	0	0%		0	0	5				1800 U	1900 U	
Aniline	UG/KG	0	0%		0	0	48	2000 U	3700 U	1900 U			750 U
Anthracene	UG/KG	6600	100%	50000	0	53	53	2500	2400 J	2900	4100	2300	540 J
Atrazine	UG/KG	0	0%		0	0	5				1800 U	1900 U	
Benzaldehyde	UG/KG	0	0%		0	0	5				1800 U	1900 U	
Benzo(a)anthracene	UG/KG	14000	100%	224	52	53	53	5400	8400	7800	8200	6900	1600
Benzo(a)pyrene	UG/KG	16000	100%	61	53	53	53	5800	11000	9400	9500	7400	1900
Benzo(b)fluoranthene	UG/KG	11000	100%	1100	46	53	53	3900	7300	6700	10000	8100	1600
Benzo(ghi)perylene	UG/KG	8000	100%	50000	0	53	53	3300	6400	5500	5400	4200	1000
Benzo(k)fluoranthene	UG/KG	13000	100%	1100	46	53	53	3900	7200	6500	4200	3200	1600
Benzoic Acid	UG/KG	0	0%	2700	0	0	48	10000 U	19000 U	9900 U			3900 UJ
Bis(2-Chloroethoxy)methane	UG/KG	0	0%		0	0	5				1800 U	1900 U	
Bis(2-Chloroethyl)ether	UG/KG	0	0%		0	0	5				1800 U	1900 U	
Bis(2-Ethylhexyl)phthalate	UG/KG	130	6%	50000	0	3	53	2000 U	3700 U	1900 U	1800 U	1900 U	750 U
Butylbenzylphthalate	UG/KG	0	0%	50000	0	0	53	2000 U	3700 U	1900 U	1800 U	1900 U	750 U
Caprolactam	UG/KG	0	0%		0	0	5				1800 U	1900 U	
Carbazole	UG/KG	1100	80%		0	4	5				1100 J	320 J	

Table A-6
SOIL SAMPLE RESULTS
SEAD-59 STOCKPILE
SEAD-59 and SEAD-71 Phase II RI Report
Seneca Army Depot Activity

Facility	SEAD-59						SEAD-59						
Location ID	WS-59-01-008-1		WS-59-01-008-2		WS-59-01-008-3		WS-59-01-011-1		WS-59-01-011-2		WS-59-01-011-5		
Matrix	SOIL						SOIL						
Sample ID	WS-59-01-008-1		WS-59-01-008-2		WS-59-01-008-3		WS-59-01-011-1		WS-59-01-011-2		WS-59-01-011-5		
Sample Depth to Top of Sample	0						0						
Sample Depth to Bottom of Sample	0						0						
Sample Date	5/6/2004		5/6/2004		5/6/2004		5/6/2004		5/6/2004		5/6/2004		
QC Code	SA						SA						
Study ID	ENSR IRM		ENSR IRM		ENSR IRM		ENSR IRM		ENSR IRM		ENSR IRM		
	1		1		1		1		1		1		
Parameter	Units	Maximum Value	Frequency of Detection	NYSDEC TAGM Level	Number of Exceedances	Number of Times Detected	Number of Sample Analyses	Value (Q)	Value (Q)	Value (Q)	Value (Q)	Value (Q)	Value (Q)
Chrysene	UG/KG	13000	100%	400	52	53	53	5400 J	8500	7900	8000	6600	1600
Di-n-butylphthalate	UG/KG	0	0%	8100	0	0	53	2000 U	3700 U	1900 U	1800 U	1900 U	750 U
Di-n-octylphthalate	UG/KG	0	0%	50000	0	0	53	2000 U	3700 U	1900 U	1800 U	1900 U	750 U
Dibenz(a,h)anthracene	UG/KG	2900	98%	14	52	53	53	1200 J	2200 J	1900 J	1600 J	1200 J	330 J
Dibenzofuran	UG/KG	1300	62%	6200	0	33	53	440 J	3700 U	460 J	950 J	230 J	750 U
Diethyl phthalate	UG/KG	0	0%	7100	0	0	53	2000 U	3700 U	1900 U	1800 U	1900 U	750 U
Dimethylphthalate	UG/KG	0	0%	2000	0	0	53	2000 U	3700 U	1900 U	1800 U	1900 U	750 U
Fluoranthene	UG/KG	29000	100%	50000	0	53	53	9300	14000	14000	13000	12000	2900
Fluorene	UG/KG	3100	89%	50000	0	47	53	1100 J	700 J	1200 J	1900	700 J	140 J
Hexachlorobenzene	UG/KG	0	0%	410	0	0	53	2000 U	3700 U	1900 U	1800 U	1900 U	750 U
Hexachlorobutadiene	UG/KG	0	0%	0	0	0	53	2000 U	3700 U	1900 U	1800 U	1900 U	750 U
Hexachlorocyclopentadiene	UG/KG	0	0%	0	0	0	5				1800 U	1900 U	
Hexachloroethane	UG/KG	0	0%	0	0	0	53	2000 U	3700 U	1900 U	1800 U	1900 U	750 U
Indeno(1,2,3-cd)pyrene	UG/KG	8000	100%	3200	19	53	53	3100 J	5900 J	5200 J	5800	4500	1000 J
Isophorone	UG/KG	0	0%	4400	0	0	53	2000 U	3700 U	1900 U	1800 U	1900 U	750 U
N-Nitrosodiphenylamine	UG/KG	0	0%	0	0	0	5				1800 U	1900 U	
N-Nitrosodipropylamine	UG/KG	0	0%	0	0	0	5				1800 U	1900 U	
Naphthalene	UG/KG	1200	62%	13000	0	33	53	510 J	3700 U	370 J	1100 J	260 J	750 U
Nitrobenzene	UG/KG	0	0%	200	0	0	53	2000 U	3700 U	1900 U	1800 U	1900 U	750 U
Pentachlorophenol	UG/KG	660	2%	1000	0	1	53	10000 U	19000 U	9900 U	4500 U	4700 U	3900 U
Phenanthrene	UG/KG	17000	100%	50000	0	53	53	7100	4500	7600	12000	5200	1400
Phenol	UG/KG	0	0%	30	0	0	53	2000 U	3700 U	1900 U	1800 U	1900 U	750 U
Pyrene	UG/KG	22000	100%	50000	0	53	53	9000	13000	12000	13000	14000	2600
Pyridine	UG/KG	0	0%	0	0	0	48	10000 U	19000 U	9900 U			3900 U
Pesticides/PCBs													
4,4'-DDD	UG/KG	450	62%	2900	0	33	53	29	19	43	60 J	15 J	95
4,4'-DDE	UG/KG	230	62%	2100	0	33	53	21	18 U	19 U	36 NJ	28 NJ	51 J
4,4'-DDT	UG/KG	520	70%	2100	0	37	53	37 J	33 J	35	110 J	38 J	70 J
Aldrin	UG/KG	0	0%	41	0	0	53	10 U	9.5 U	10 U	9.2 U	1.9 U	9.6 U
Alpha-BHC	UG/KG	4.4	2%	110	0	1	53	10 U	9.5 U	10 U	9.2 U	4.4	9.6 U
Alpha-Chlordane	UG/KG	27	11%	0	0	6	53	10 U	9.5 U	10 U	9.2 U	15	9.6 U
Beta-BHC	UG/KG	13	2%	200	0	1	53	10 U	9.5 U	10 U	9.2 U	1.9 U	9.6 U
Delta-BHC	UG/KG	0	0%	300	0	0	53	10 U	9.5 U	10 U	9.2 U	1.9 U	9.6 U
Dieldrin	UG/KG	0	0%	44	0	0	53	20 U	18 U	19 U	18 U	3.8 U	19 U
Endosulfan I	UG/KG	0	0%	900	0	0	53	10 U	9.5 U	10 U	9.2 U	1.9 U	9.6 U
Endosulfan II	UG/KG	0	0%	900	0	0	53	20 U	18 U	19 U	18 U	3.8 U	19 U
Endosulfan sulfate	UG/KG	0	0%	1000	0	0	53	20 U	18 U	19 U	18 U	3.8 U	19 U
Endrin	UG/KG	0	0%	100	0	0	53	20 U	18 U	19 U	18 U	3.8 U	19 U
Endrin aldehyde	UG/KG	0	0%	0	0	0	53	20 U	18 U	19 U	18 U	3.8 U	19 U
Endrin ketone	UG/KG	15	2%	0	0	1	53	20 U	18 U	19 U	18 U	15 J	19 U

Table A-6
SOIL SAMPLE RESULTS
SEAD-59 STOCKPILE
SEAD-59 and SEAD-71 Phase II RI Report
Seneca Army Depot Activity

Facility	Location ID	Matrix	Sample ID	Sample Depth to Top of Sample	Sample Depth to Bottom of Sample	Sample Date	QC Code	Study ID	SEAD-59 WS-59-01-008-1	SEAD-59 WS-59-01-008-2	SEAD-59 WS-59-01-008-3	SEAD-59 WS-59-01-011-1	SEAD-59 WS-59-01-011-2	SEAD-59 WS-59-01-011-5
Parameter	Units	Maximum Value	Frequency of Detection	NYSDEC TAGM Level	Number of Exceedances	Number of Times Detected	Number of Sample Analyses		ENSR IRM 1	ENSR IRM 1	ENSR IRM 1	ENSR IRM 1	ENSR IRM 1	ENSR IRM 1
									Value (Q)	Value (Q)	Value (Q)	Value (Q)	Value (Q)	Value (Q)
Gamma-BHC/Lindane	UG/KG	0	0%	60	0	53	53		10 U	9.5 U	10 U	9.2 U	1.9 U	9.6 U
Gamma-Chlordane	UG/KG	21	9%	540	0	5	53		10 U	9.5 U	10 U	9.2 U	7.9	9.6 U
Heptachlor	UG/KG	0	0%	100	0	0	53		10 U	9.5 U	10 U	9.2 UJ	1.9 UJ	9.6 U
Heptachlor epoxide	UG/KG	0	0%	20	0	0	53		10 U	9.5 U	10 U	9.2 U	1.9 U	9.6 U
Methoxychlor	UG/KG	0	0%	0	0	0	53		100 U	95 U	99 U	92 U	19 U	96 U
Toxaphene	UG/KG	0	0%	0	0	0	53		200 U	180 U	190 U	920 U	190 U	190 U
Aroclor-1016	UG/KG	0	0%	0	0	0	53		39 U	37 U	39 U	36 U	38 U	37 U
Aroclor-1221	UG/KG	0	0%	0	0	0	53		39 U	37 U	39 U	36 U	38 U	37 U
Aroclor-1232	UG/KG	0	0%	0	0	0	53		39 U	37 U	39 U	36 U	38 U	37 U
Aroclor-1242	UG/KG	0	0%	0	0	0	53		39 U	37 U	39 U	36 U	38 U	37 U
Aroclor-1248	UG/KG	0	0%	0	0	0	53		39 U	37 U	39 U	36 U	38 U	37 U
Aroclor-1254	UG/KG	0	0%	10000	0	0	53		39 U	37 U	39 U	36 U	38 U	37 U
Aroclor-1260	UG/KG	0	0%	10000	0	0	53		39 U	37 U	39 U	36 U	38 U	37 U
Metals														
Aluminum	MG/KG	13400	100%	19300	0	53	53		12200	11100	10500	12300 J	12600 J	9220
Antimony	MG/KG	43.9	21%	5.9	3	11	53		3.5 UJ	3.2 UJ	3.5 UJ	1.9 J	1.3 J	15.6J
Arsenic	MG/KG	7.3	100%	8.2	0	53	53		5.2	4.9	4.1	5.4 J	5.8 J	3.6 J
Barium	MG/KG	135	100%	300	0	53	53		101	82.6	115	84.7 J	104 J	97.6
Beryllium	MG/KG	0.69	100%	1.1	0	53	53		0.36 J	0.34 J	0.14 J	0.61	0.63	0.22
Cadmium	MG/KG	1.2	98%	2.3	0	52	53		0.52 J	0.62	0.41 J	0.46	0.46	0.35 J
Calcium	MG/KG	100000	100%	121000	0	53	53		33800 J	49700 J	68800 J	52200 J	32900 J	46100
Chromium	MG/KG	35	100%	29.6	3	53	53		20.5	20.5	16.7	19.9 J	19 J	15.4 J
Cobalt	MG/KG	13.9	100%	30	0	53	53		10.3	10.3	8.4	10.1 J	8.5 J	8.5
Copper	MG/KG	51.8	100%	33	14	53	53		29.4	27.2	25	25.6 J	26.4 J	25.3 J
Iron	MG/KG	26500	100%	36500	0	53	53		21900	26500	18800 J	23100	21700	17000
Lead	MG/KG	1440	100%	24.8	51	53	53		33.9J	34.8J	28.1J	33.4J	34.2J	41.5J
Magnesium	MG/KG	26600	100%	21500	1	53	53		7700 J	11300 J	26600J	7240 J	6890 J	10800
Manganese	MG/KG	1220	100%	1060	2	53	53		416	466	619	499 J	446 J	452
Mercury	MG/KG	0.52	100%	0.1	9	53	53		0.11	0.04	0.05	0.04	0.07	0.08
Nickel	MG/KG	56.6	100%	49	1	53	53		30.7	32	24.6	31 J	26.1 J	23.8 J
Potassium	MG/KG	1580	100%	2380	0	53	53		1490	1290	1420	1580 J	1360 J	936
Selenium	MG/KG	0.72	4%	2	0	2	53		0.59 U	0.54 U	0.58 U	0.37 U	0.41 U	1.1 UJ
Silver	MG/KG	4.7	17%	0.75	6	9	53		0.59 U	0.54 U	0.58 U	0.56	0.93	0.55 U
Sodium	MG/KG	525	100%	172	23	53	53		174	134	137	200J	199J	240
Thallium	MG/KG	0.99	51%	0.7	12	27	53		0.78J	0.61 J	0.74J	0.19 U	0.21 U	0.67 J
Vanadium	MG/KG	35.4	100%	150	0	53	53		22.9	22.5	20.4	22 J	21.8 J	16.1
Zinc	MG/KG	185	100%	110	6	53	53		118J	84.5 J	75 J	73.7 J	78.4 J	96 J

Note(s):

(1) - NYSDEC Technical and Administrative Guidance Memorandum (TAGM) HWR-94-4046, Revised January 24, 1994

(2) - Sample-Duplicate pairs are presented as a combined sample in this table.

Their Sample ID is a combination of the sample and the sample duplicate Sample ID (for example FD-59-CL-05/CL-59-01-WS1)

In addition, the 'QC Code' field is labeled 'SADU'

U = compound was not detected

J = the reported value is an estimated concentration

UJ = the compound was not detected; the associated reporting limit is approximate

R = the data was rejected in the data validating process

NJ = compound was "tentatively identified" and the associated numerical value is approximate

**Table A-6
SOIL SAMPLE RESULTS
SEAD-59 STOCKPILE
SEAD-59 and SEAD-71 Phase II RI Report
Seneca Army Depot Activity**

Facility	SEAD-59	SEAD-59	SEAD-59	SEAD-59	SEAD-59	SEAD-59							
Location ID	WS-59-01-011-6	WS-59-01-011-7	WS-59-01-011-8	WS-59-01-011-9	WS-59-01-012-2	WS-59-01-012-3							
Matrix	SOIL	SOIL	SOIL	SOIL	SOIL	SOIL							
Sample ID	WS-59-01-011-6	WS-59-01-011-7	WS-59-01-011-8	WS-59-01-011-9	WS-59-01-012-2	WS-59-01-012-3							
Sample Depth to Top of Sample	0	0	0	0	0	0							
Sample Depth to Bottom of Sample	0	0	0	0	0	0							
Sample Date	5/6/2004	5/6/2004	5/6/2004	5/6/2004	5/6/2004	5/6/2004							
QC Code	SA	SA	SA	SA	SA	SA							
Study ID	ENSR IRM	ENSR IRM	ENSR IRM	ENSR IRM	ENSR IRM	ENSR IRM							
Parameter	Units	Maximum Value	Frequency of Detection	NYSDEC TAGM Level	Number of Exceedances	Number of Times Detected	Number of Sample Analyses	Value (Q)	Value (Q)	Value (Q)	Value (Q)	Value (Q)	Value (Q)
Volatile Organic Compounds													
1,1,1-Trichloroethane	UG/KG	0	0%	800	0	0	53	5.6 U	5.8 U	5.6 U	5.9 U	6 U	5.6 U
1,1,2,2-Tetrachloroethane	UG/KG	0	0%	600	0	0	52	5.6 U	5.8 U	5.6 U	5.9 U	6 U	5.6 U
1,1,2-Trichloro-1,2,2-Trifluoroethane	UG/KG	1.5	2%		0	1	53	5.6 U	5.8 U	5.6 U	5.9 U	6 U	5.6 U
1,1,2-Trichloroethane	UG/KG	0	0%		0	0	5					6 U	
1,1-Dichloroethane	UG/KG	0	0%	200	0	0	53	5.6 U	5.8 U	5.6 U	5.9 U	6 U	5.6 U
1,1-Dichloroethene	UG/KG	1	2%	400	0	1	53	5.6 U	5.8 U	5.6 U	5.9 U	6 U	5.6 U
1,2,3-Trichloropropane	UG/KG	0	0%		0	0	47	5.6 U	5.8 U	5.6 U	5.9 U		5.6 U
1,2,4-Trichlorobenzene	UG/KG	0	0%	3400	0	0	52	5.6 U	5.8 U	5.6 U	5.9 U	6 U	5.6 U
1,2-Dibromo-3-chloropropane	UG/KG	0	0%		0	0	5					6 U	
1,2-Dibromoethane	UG/KG	0	0%		0	0	5					6 U	
1,2-Dichlorobenzene	UG/KG	0	0%	7900	0	0	52	5.6 U	5.8 U	5.6 U	5.9 U	6 U	5.6 U
1,2-Dichloroethane	UG/KG	0	0%	100	0	0	53	5.6 U	5.8 U	5.6 U	5.9 U	6 U	5.6 U
1,2-Dichloropropane	UG/KG	0	0%		0	0	5					6 U	
1,3-Dichlorobenzene	UG/KG	0	0%	1600	0	0	52	5.6 U	5.8 U	5.6 U	5.9 U	6 U	5.6 U
1,3-Dichloropropane	UG/KG	0	0%		0	0	48	5.6 U	5.8 U	5.6 U	5.9 U		5.6 U
1,4-Dichlorobenzene	UG/KG	0	0%	8500	0	0	52	5.6 U	5.8 U	5.6 U	5.9 U	6 U	5.6 U
Acetone	UG/KG	69	25%	200	0	13	53	22 U	23 U	22 U	24 U	69 NJ	22 U
Benzene	UG/KG	0	0%	60	0	0	53	5.6 U	5.8 U	5.6 U	5.9 U	6 U	5.6 U
Bromodichloromethane	UG/KG	0	0%		0	0	5					6 U	
Bromoform	UG/KG	0	0%		0	0	5					6 U	
Carbon disulfide	UG/KG	0	0%	2700	0	0	53	5.6 U	5.8 U	5.6 U	5.9 U	6 U	5.6 U
Carbon tetrachloride	UG/KG	0	0%	600	0	0	53	5.6 U	5.8 U	5.6 U	5.9 U	6 U	5.6 U
Chlorobenzene	UG/KG	0	0%	1700	0	0	53	5.6 U	5.8 U	5.6 U	5.9 U	6 U	5.6 U
Chlorodibromomethane	UG/KG	0	0%		0	0	53	5.6 U	5.8 U	5.6 U	5.9 U	6 U	5.6 U
Chloroethane	UG/KG	0	0%	1900	0	0	53	11 U	12 U	11 U	12 U	6 U	11 U
Chloroform	UG/KG	0	0%	300	0	0	53	5.6 U	5.8 U	5.6 U	5.9 U	6 U	5.6 U
Cis-1,2-Dichloroethene	UG/KG	0	0%		0	0	5					6 U	
Cis-1,3-Dichloropropene	UG/KG	0	0%		0	0	5					6 U	
Cyclohexane	UG/KG	0	0%		0	0	5					6 U	
Dichlorodifluoromethane	UG/KG	0	0%		0	0	5					6 U	
Ethyl benzene	UG/KG	0	0%	5500	0	0	53	5.6 U	5.8 U	5.6 U	5.9 U	6 U	5.6 U
Isopropylbenzene	UG/KG	0	0%		0	0	5					6 U	
Meta/Para Xylene	UG/KG	2.3	4%		0	2	48	5.6 U	5.8 U	5.6 U	5.9 U		5.6 U
Methyl Acetate	UG/KG	0	0%		0	0	5					6 U	
Methyl Tertbutyl Ether	UG/KG	0	0%		0	0	5					6 U	
Methyl bromide	UG/KG	0	0%		0	0	5					6 U	
Methyl butyl ketone	UG/KG	0	0%		0	0	5					6 U	
Methyl chloride	UG/KG	0	0%		0	0	5					6 U	
Methyl cyclohexane	UG/KG	0	0%		0	0	5					6 U	
Methyl ethyl ketone	UG/KG	7	9%	300	0	5	53	11 U	12 U	11 U	12 U	7 J	11 U
Methyl isobutyl ketone	UG/KG	0	0%	1000	0	0	53	11 U	12 U	11 U	12 U	6 U	11 U
Methylene chloride	UG/KG	3.45	2%	100	0	1	53	5.6 U	5.8 U	5.6 U	5.9 U	6 U	5.6 U
Ortho Xylene	UG/KG	1.9	10%		0	5	48	5.6 U	5.8 U	5.6 U	5.9 U		5.6 U
Styrene	UG/KG	0	0%		0	0	5					6 U	
Tetrachloroethene	UG/KG	6.7	6%	1400	0	3	53	5.6 U	5.8 U	5.6 U	5.9 U	6 U	5.6 U
Toluene	UG/KG	0	0%	1500	0	0	53	5.6 U	5.8 U	5.6 U	5.9 U	6 U	5.6 U
Total Xylenes	UG/KG	3	20%	1200	0	1	5					6 U	
Trans-1,2-Dichloroethene	UG/KG	0	0%	300	0	0	53	5.6 U	5.8 U	5.6 U	5.9 U	6 U	5.6 U

**Table A-6
SOIL SAMPLE RESULTS
SEAD-59 STOCKPILE
SEAD-59 and SEAD-71 Phase II RI Report
Seneca Army Depot Activity**

Facility	SEAD-59	SEAD-59	SEAD-59	SEAD-59	SEAD-59	SEAD-59							
Location ID	WS-59-01-011-6	WS-59-01-011-7	WS-59-01-011-8	WS-59-01-011-9	WS-59-01-012-2	WS-59-01-012-3							
Matrix	SOIL	SOIL	SOIL	SOIL	SOIL	SOIL							
Sample ID	WS-59-01-011-6	WS-59-01-011-7	WS-59-01-011-8	WS-59-01-011-9	WS-59-01-012-2	WS-59-01-012-3							
Sample Depth to Top of Sample	0	0	0	0	0	0							
Sample Depth to Bottom of Sample	0	0	0	0	0	0							
Sample Date	5/6/2004	5/6/2004	5/6/2004	5/6/2004	5/6/2004	5/6/2004							
QC Code	SA	SA	SA	SA	SA	SA							
Study ID	ENSR IRM	ENSR IRM	ENSR IRM	ENSR IRM	ENSR IRM	ENSR IRM							
	1	1	1	1	1	1							
Parameter	Units	Maximum Value	Frequency of Detection	NYSDEC TAGM Level	Number of Exceedances	Number of Times Detected	Number of Sample Analyses	Value (Q)	Value (Q)	Value (Q)	Value (Q)	Value (Q)	Value (Q)
Trans-1,3-Dichloropropene	UG/KG	0	0%		0	0	5						6 U
Trichloroethene	UG/KG	4.2	8%	700	0	4	53	5.6 U	5.8 U	5.6 U	5.9 U	6 U	5.6 U
Trichlorofluoromethane	UG/KG	0	0%		0	0	5					6 U	
Vinyl chloride	UG/KG	0	0%	200	0	0	53	11 U	12 U	11 U	12 U	6 U	11 U
Semivolatile Organics Compounds													
1,1'-Biphenyl	UG/KG	59	20%		0	1	5						59 J
2,2'-oxybis(1-Chloropropane)	UG/KG	0	0%		0	0	5						380 U
2,4,5-Trichlorophenol	UG/KG	0	0%	100	0	0	53	1900 U	3800 U	1800 U	2000 U	950 U	1800 U
2,4,6-Trichlorophenol	UG/KG	0	0%		0	0	53	1900 U	3800 U	1800 U	2000 U	380 U	1800 U
2,4-Dichlorophenol	UG/KG	0	0%	400	0	0	53	1900 U	3800 U	1800 U	2000 U	380 U	1800 U
2,4-Dimethylphenol	UG/KG	0	0%		0	0	5						380 U
2,4-Dinitrophenol	UG/KG	0	0%	200	0	0	53	9600 U	20000 U	9500 U	10000 U	950 UJ	9500 U
2,4-Dinitrotoluene	UG/KG	0	0%		0	0	53	1900 U	3800 U	1800 U	2000 U	380 U	1800 U
2,6-Dinitrotoluene	UG/KG	0	0%	1000	0	0	53	1900 U	3800 U	1800 U	2000 U	380 U	1800 U
2-Chloronaphthalene	UG/KG	0	0%		0	0	5						380 U
2-Chlorophenol	UG/KG	0	0%	800	0	0	53	1900 U	3800 U	1800 U	2000 U	380 U	1800 U
2-Methylnaphthalene	UG/KG	1200	51%	36400	0	27	53	490 J	3800 U	580 J	210 J	300 J	710 J
2-Methylphenol	UG/KG	0	0%	100	0	0	53	1900 U	3800 U	1800 U	2000 U	380 U	1800 U
2-Nitroaniline	UG/KG	0	0%	430	0	0	53	9600 U	20000 U	9500 U	10000 U	950 U	9500 U
2-Nitrophenol	UG/KG	0	0%	330	0	0	53	1900 U	3800 U	1800 U	2000 U	380 U	1800 U
3,3'-Dichlorobenzidine	UG/KG	0	0%		0	0	53	1900 U	3800 U	1800 U	2000 U	380 UJ	1800 U
3-Nitroaniline	UG/KG	0	0%	500	0	0	53	9600 U	20000 U	9500 U	10000 U	950 U	9500 U
4,6-Dinitro-2-methylphenol	UG/KG	0	0%		0	0	5						950 U
4-Bromophenyl phenyl ether	UG/KG	0	0%		0	0	5						380 U
4-Chloro-3-methylphenol	UG/KG	0	0%	240	0	0	53	1900 U	3800 U	1800 U	2000 U	380 U	1800 U
4-Chloroaniline	UG/KG	0	0%	220	0	0	53	1900 U	3800 U	1800 U	2000 U	380 UJ	1800 U
4-Chlorophenyl phenyl ether	UG/KG	0	0%		0	0	5						380 U
4-Methylphenol	UG/KG	0	0%	900	0	0	53	1900 U	3800 U	1800 U	2000 U	380 U	1800 U
4-Nitroaniline	UG/KG	0	0%		0	0	5						950 U
4-Nitrophenol	UG/KG	0	0%	100	0	0	53	9600 U	20000 U	9500 U	10000 U	950 U	9500 U
Acenaphthene	UG/KG	2400	87%	50000	0	46	53	560 J	900 J	1300 J	520 J	440	850 J
Acenaphthylene	UG/KG	3500	98%	41000	0	52	53	1700 J	3200 J	3300	2600	930	3000
Acetophenone	UG/KG	0	0%		0	0	5						380 U
Aniline	UG/KG	0	0%		0	0	48	1900 U	3800 U	1800 U	2000 U		1800 U
Anthracene	UG/KG	6600	100%	50000	0	53	53	2200	4300	4900	2500	1500	3400
Atrazine	UG/KG	0	0%		0	0	5						380 U
Benzaldehyde	UG/KG	0	0%		0	0	5						380 U
Benzo(a)anthracene	UG/KG	14000	100%	224	52	53	53	5800	14000	12000	7700	5700 NJ	10000
Benzo(a)pyrene	UG/KG	16000	100%	61	53	53	53	6300	16000	15000	9900	5700	16000
Benzo(b)fluoranthene	UG/KG	11000	100%	1100	46	53	53	4600	11000	11000	7700	6500	11000
Benzo(ghi)perylene	UG/KG	8000	100%	50000	0	53	53	3100	8000	7000	5200	2700 J	7600
Benzo(k)fluoranthene	UG/KG	13000	100%	1100	46	53	53	5100	13000	11000	7600	3200	13000
Benzoic Acid	UG/KG	0	0%	2700	0	0	48	9600 UJ	20000 UJ	9500 UJ	10000 UJ		9500 UJ
Bis(2-Chloroethoxy)methane	UG/KG	0	0%		0	0	5						380 U
Bis(2-Chloroethyl)ether	UG/KG	0	0%		0	0	5						380 U
Bis(2-Ethylhexyl)phthalate	UG/KG	130	6%	50000	0	3	53	1900 U	3800 U	1800 U	2000 U	130 NJ	1800 U
Butylbenzylphthalate	UG/KG	0	0%	50000	0	0	53	1900 U	3800 U	1800 U	2000 U	380 UJ	1800 U
Caprolactam	UG/KG	0	0%		0	0	5						380 U
Carbazole	UG/KG	1100	80%		0	4	5						240 J

Table A-6
SOIL SAMPLE RESULTS
SEAD-59 STOCKPILE
SEAD-59 and SEAD-71 Phase II RI Report
Seneca Army Depot Activity

Facility							SEAD-59	SEAD-59	SEAD-59	SEAD-59	SEAD-59	SEAD-59	
Location ID							WS-59-01-011-6	WS-59-01-011-7	WS-59-01-011-8	WS-59-01-011-9	WS-59-01-012-2	WS-59-01-012-3	
Matrix							SOIL	SOIL	SOIL	SOIL	SOIL	SOIL	
Sample ID							WS-59-01-011-6	WS-59-01-011-7	WS-59-01-011-8	WS-59-01-011-9	WS-59-01-012-2	WS-59-01-012-3	
Sample Depth to Top of Sample							0	0	0	0	0	0	
Sample Depth to Bottom of Sample							0	0	0	0	0	0	
Sample Date							5/6/2004	5/6/2004	5/6/2004	5/6/2004	5/6/2004	5/6/2004	
QC Code							SA	SA	SA	SA	SA	SA	
Study ID							ENSR IRM	ENSR IRM	ENSR IRM	ENSR IRM	ENSR IRM	ENSR IRM	
		Maximum	Frequency	NYSDEC	Number	Number	Number	Value (Q)	Value (Q)	Value (Q)	Value (Q)	Value (Q)	Value (Q)
Parameter	Units	Value	of Detection	TAGM Level	of Exceedances	of Times Detected	of Sample Analyses						
Chrysene	UG/KG	13000	100%	400	52	53	53	5900	13000	12000	7700	5600	11000
Di-n-butylphthalate	UG/KG	0	0%	8100	0	0	53	1900 U	3800 U	1800 U	2000 U	380 U	1800 U
Di-n-octylphthalate	UG/KG	0	0%	50000	0	0	53	1900 U	3800 U	1800 U	2000 U	380 U	1800 U
Dibenz(a,h)anthracene	UG/KG	2900	98%	14	52	52	53	1100 J	2800 J	2600 J	1900 J	820 J	2900 J
Dibenzofuran	UG/KG	1300	62%	6200	0	33	53	420 J	510 J	770 J	240 J	260 J	650 J
Diethyl phthalate	UG/KG	0	0%	7100	0	0	53	1900 U	3800 U	1800 U	2000 U	380 U	1800 U
Dimethylphthalate	UG/KG	0	0%	2000	0	0	53	1900 U	3800 U	1800 U	2000 U	380 U	1800 U
Fluoranthene	UG/KG	29000	100%	50000	0	53	53	10000	23000	21000	12000	7300	20000
Fluorene	UG/KG	3100	89%	50000	0	47	53	880 J	1200 J	1800 J	700 J	690	1300 J
Hexachlorobenzene	UG/KG	0	0%	410	0	0	53	1900 U	3800 U	1800 U	2000 U	380 U	1800 U
Hexachlorobutadiene	UG/KG	0	0%	0	0	0	53	1900 U	3800 U	1800 U	2000 U	380 U	1800 U
Hexachlorocyclopentadiene	UG/KG	0	0%	0	0	0	5					380 U	
Hexachloroethane	UG/KG	0	0%	0	0	0	53	1900 U	3800 U	1800 U	2000 U	380 U	1800 U
Indeno(1,2,3-cd)pyrene	UG/KG	8000	100%	3200	19	53	53	3000 J	8000 J	7000 J	5100 J	2600 J	7800 J
Isophorone	UG/KG	0	0%	4400	0	0	53	1900 U	3800 U	1800 U	2000 U	380 U	1800 U
N-Nitrosodiphenylamine	UG/KG	0	0%	0	0	0	5					380 U	
N-Nitrosodipropylamine	UG/KG	0	0%	0	0	0	5					380 U	
Naphthalene	UG/KG	1200	62%	13000	0	33	53	520 J	400 J	570 J	270 J	350 J	840 J
Nitrobenzene	UG/KG	0	0%	200	0	0	53	1900 U	3800 U	1800 U	2000 U	380 U	1800 U
Pentachlorophenol	UG/KG	660	2%	1000	0	1	53	9600 U	20000 U	9500 U	10000 U	950 U	9500 U
Phenanthrene	UG/KG	17000	100%	50000	0	53	53	6400	9500	12000	4600	3400	8100
Phenol	UG/KG	0	0%	30	0	0	53	1900 U	3800 U	1800 U	2000 U	380 U	1800 U
Pyrene	UG/KG	22000	100%	50000	0	53	53	8900	20000	18000	11000	9300	22000
Pyridine	UG/KG	0	0%	0	0	0	48	9600 U	20000 U	9500 U	10000 U		9500 U
Pesticides/PCBs													
4,4'-DDD	UG/KG	450	62%	2900	0	33	53	70	35	48	20 U	9.3 NJ	51 J
4,4'-DDE	UG/KG	230	62%	2100	0	33	53	130	71	120	51	24 NJ	160
4,4'-DDT	UG/KG	520	70%	2100	0	37	53	160	110 J	120	45 J	7	92 J
Aldrin	UG/KG	0	0%	41	0	0	53	9.6 U	9.9 U	9.5 U	10 U	2 U	9.5 U
Alpha-BHC	UG/KG	4.4	2%	110	0	1	53	9.6 U	9.9 U	9.5 U	10 U	2 U	9.5 U
Alpha-Chlordane	UG/KG	27	11%	0	0	6	53	18 J	9.9 U	27 J	10 U	2 U	9.5 U
Beta-BHC	UG/KG	13	2%	200	0	1	53	9.6 U	9.9 U	9.5 U	10 U	2 U	9.5 U
Delta-BHC	UG/KG	0	0%	300	0	0	53	9.6 U	9.9 U	9.5 U	10 U	2 U	9.5 U
Dieldrin	UG/KG	0	0%	44	0	0	53	19 U	19 U	18 U	20 U	3.8 U	18 U
Endosulfan I	UG/KG	0	0%	900	0	0	53	9.6 U	9.9 U	9.5 U	10 U	2 U	9.5 U
Endosulfan II	UG/KG	0	0%	900	0	0	53	19 U	19 U	18 U	20 U	3.8 U	18 U
Endosulfan sulfate	UG/KG	0	0%	1000	0	0	53	19 U	19 U	18 U	20 U	3.8 U	18 U
Endrin	UG/KG	0	0%	100	0	0	53	19 U	19 U	18 U	20 U	3.8 U	18 U
Endrin aldehyde	UG/KG	0	0%	0	0	0	53	19 U	19 U	18 U	20 U	3.8 U	18 U
Endrin ketone	UG/KG	15	2%	0	0	1	53	19 U	19 U	18 U	20 U	3.8 U	18 U

Table A-6
SOIL SAMPLE RESULTS
SEAD-59 STOCKPILE
SEAD-59 and SEAD-71 Phase II RI Report
Seneca Army Depot Activity

Facility	Location ID	Matrix	Sample ID	Sample Depth to Top of Sample	Sample Depth to Bottom of Sample	Sample Date	QC Code	Study ID	SEAD-59	SEAD-59	SEAD-59	SEAD-59	SEAD-59	SEAD-59
									WS-59-01-011-6	WS-59-01-011-7	WS-59-01-011-8	WS-59-01-011-9	WS-59-01-012-2	WS-59-01-012-3
Parameter	Units	Maximum Value	Frequency of Detection	NYSDEC TAGM Level	Number of Exceedances	Number of Times Detected	Number of Sample Analyses	ENSR IRM	ENSR IRM	ENSR IRM	ENSR IRM	ENSR IRM	ENSR IRM	
								1	1	1	1	1	1	
								Value (Q)	Value (Q)	Value (Q)	Value (Q)	Value (Q)	Value (Q)	
Gamma-BHC/Lindane	UG/KG	0	0%	60	0	0	53	9.6 U	9.9 U	9.5 U	10 U	2 U	9.5 U	
Gamma-Chlordane	UG/KG	21	9%	540	0	5	53	15	9.9 U	21 J	10 U	2 U	9.5 U	
Heptachlor	UG/KG	0	0%	100	0	0	53	9.6 U	9.9 U	9.5 U	10 U	2 U	9.5 U	
Heptachlor epoxide	UG/KG	0	0%	20	0	0	53	9.6 U	9.9 U	9.5 U	10 U	2 U	9.5 U	
Methoxychlor	UG/KG	0	0%		0	0	53	96 U	99 U	95 U	100 U	20 U	95 U	
Toxaphene	UG/KG	0	0%		0	0	53	190 U	190 U	180 U	200 U	200 U	180 U	
Aroclor-1016	UG/KG	0	0%		0	0	53	37 U	38 U	37 U	39 U	38 U	37 U	
Aroclor-1221	UG/KG	0	0%		0	0	53	37 U	38 U	37 U	39 U	38 U	37 U	
Aroclor-1232	UG/KG	0	0%		0	0	53	37 U	38 U	37 U	39 U	38 U	37 U	
Aroclor-1242	UG/KG	0	0%		0	0	53	37 U	38 U	37 U	39 U	38 U	37 U	
Aroclor-1248	UG/KG	0	0%		0	0	53	37 U	38 U	37 U	39 U	38 U	37 U	
Aroclor-1254	UG/KG	0	0%	10000	0	0	53	37 U	38 U	37 U	39 U	38 U	37 U	
Aroclor-1260	UG/KG	0	0%	10000	0	0	53	37 U	38 U	37 U	39 U	38 U	37 U	
Metals														
Aluminum	MG/KG	13400	100%	19300	0	53	53	9890	7260	10300	11200	10800 J	10200	
Antimony	MG/KG	43.9	21%	5.9	3	11	53	3.2 UJ	3.5 UJ	3.4 UJ	3.5 UJ	1.7 J	3.2 UJ	
Arsenic	MG/KG	7.3	100%	8.2	0	53	53	4.7 J	3.9 J	4 J	4.7 J	5 J	4.9 J	
Barium	MG/KG	135	100%	300	0	53	53	75.5	53.6	80.1	114	71.2 J	77.9	
Beryllium	MG/KG	0.69	100%	1.1	0	53	53	0.34	0.24	0.38	0.41	0.57	0.42	
Cadmium	MG/KG	1.2	98%	2.3	0	52	53	0.33 J	0.29 J	0.37 J	0.6	0.48	0.6	
Calcium	MG/KG	100000	100%	121000	0	53	53	51600	44700	61900	34400	86700 J	46300	
Chromium	MG/KG	35	100%	29.6	3	53	53	17.4 J	15.3 J	18.4 J	19.4 J	18.6 J	17.6 J	
Cobalt	MG/KG	13.9	100%	30	0	53	53	10.6	7.7	11.2	12.6	10.1 J	12.6	
Copper	MG/KG	51.8	100%	33	14	53	53	26.8 J	18.4 J	44.7 J	26.8 J	27.5 J	30 J	
Iron	MG/KG	26500	100%	36500	0	53	53	20300	16300	19900	23200	22700 J	20800	
Lead	MG/KG	1440	100%	24.8	51	53	53	34.2 J	40.9 J	49.4 J	32.9 J	35.7 J	42.4 J	
Magnesium	MG/KG	26600	100%	21500	1	53	53	9720	8370	8540	7680	8010 J	7890	
Manganese	MG/KG	1220	100%	1060	2	53	53	456	361	475	1080	489 J	534	
Mercury	MG/KG	0.52	100%	0.1	9	53	53	0.05	0.06	0.06	0.07	0.05	0.08	
Nickel	MG/KG	56.6	100%	49	1	53	53	29.4 J	22.5 J	33.5 J	36.1 J	32.8 J	33.4 J	
Potassium	MG/KG	1580	100%	2380	0	53	53	1060	781	1100	1150	1340 J	1160	
Selenium	MG/KG	0.72	4%	2	0	2	53	1.1 UJ	1.2 UJ	1.1 UJ	1.2 UJ	0.43 U	1.1 UJ	
Silver	MG/KG	4.7	17%	0.75	6	9	53	0.56 U	0.55 U	0.52 U	0.56 U	0.11 U	0.56 U	
Sodium	MG/KG	525	100%	172	23	53	53	206	129	115	148	163 J	103	
Thallium	MG/KG	0.99	51%	0.7	12	27	53	0.56 J	0.58 U	0.64 J	0.93 J	0.22 U	0.68 J	
Vanadium	MG/KG	35.4	100%	150	0	53	53	17.7	13.4	18.4	20.3	18 J	18	
Zinc	MG/KG	185	100%	110	6	53	53	80.4 J	57 J	89.3 J	80.9 J	69.3 J	106 J	

Note(s):
(1) - NYSDEC Technical and Administrative Guidance Memorandum (TAGM) HWR-94-4046, Revised January 24, 1994
(2) - Sample-Duplicate pairs are presented as a combined sample in this table.
Their Sample ID is a combination of the sample and the sample duplicate Sample ID (for example FD-59-CL-05/CL-59-01-WS1)
In addition, the 'QC Code' field is labeled 'SADU'

U = compound was not detected
J = the reported value is an estimated concentration
UJ = the compound was not detected; the associated reporting limit is approximate
R = the data was rejected in the data validating process
NJ = compound was "tentatively identified" and the associated numerical value is approximate

**Table A-6
SOIL SAMPLE RESULTS
SEAD-59 STOCKPILE
SEAD-59 and SEAD-71 Phase II RI Report
Seneca Army Depot Activity**

Facility	SEAD-59	SEAD-59	SEAD-59	SEAD-59	SEAD-59	SEAD-59							
Location ID	WS-59-01-013-2	WS-59-01-014-5	WS-59-01-015-14	WS-59-01-015-15	WS-59-01-015-16	WS-59-01-015-17							
Matrix	SOIL	SOIL	SOIL	SOIL	SOIL	SOIL							
Sample ID	WS-59-01-013-2	WS-59-01-014-5	WS-59-01-015-14	WS-59-01-015-15	WS-59-01-015-16	WS-59-01-015-17							
Sample Depth to Top of Sample	0	0	0	0	0	0							
Sample Depth to Bottom of Sample	0	0	0	0	0	0							
Sample Date	5/6/2004	5/6/2004	5/6/2004	5/6/2004	5/6/2004	5/6/2004							
QC Code	SA	SA	SA	SA	SA	SA							
Study ID	ENSR IRM	ENSR IRM	ENSR IRM	ENSR IRM	ENSR IRM	ENSR IRM							
Parameter	Units	Maximum Value	Frequency of Detection	NYSDEC TAGM Level	Number of Exceedances	Number of Times Detected	Number of Sample Analyses	Value (Q)	Value (Q)	Value (Q)	Value (Q)	Value (Q)	Value (Q)
Volatile Organic Compounds													
1,1,1-Trichloroethane	UG/KG	0	0%	800	0	0	53	5.7 U	5 U	6 U	5.8 U	5.7 U	5.7 U
1,1,2,2-Tetrachloroethane	UG/KG	0	0%	600	0	0	52	5.7 U	5 UJ	6 U	5.8 U	5.7 U	5.7 U
1,1,2-Trichloro-1,2,2-Trifluoroethane	UG/KG	1.5	2%		0	1	53	5.7 U	5 U	6 U	5.8 U	5.7 U	5.7 U
1,1,2-Trichloroethane	UG/KG	0	0%		0	0	5		5 U				
1,1-Dichloroethane	UG/KG	0	0%	200	0	0	53	5.7 U	5 U	6 U	5.8 U	5.7 U	5.7 U
1,1-Dichloroethene	UG/KG	1	2%	400	0	1	53	5.7 U	5 U	6 U	5.8 U	5.7 U	5.7 U
1,2,3-Trichloropropane	UG/KG	0	0%		0	0	47	5.7 U		6 U	5.8 U	5.7 U	5.7 U
1,2,4-Trichlorobenzene	UG/KG	0	0%	3400	0	0	52	5.7 U	5 UJ	6 U	5.8 U	5.7 U	5.7 U
1,2-Dibromo-3-chloropropane	UG/KG	0	0%		0	0	5		5 UJ				
1,2-Dibromoethane	UG/KG	0	0%		0	0	5		5 U				
1,2-Dichlorobenzene	UG/KG	0	0%	7900	0	0	52	5.7 U	5 UJ	6 U	5.8 U	5.7 U	5.7 U
1,2-Dichloroethane	UG/KG	0	0%	100	0	0	53	5.7 U	5 U	6 U	5.8 U	5.7 U	5.7 U
1,2-Dichloropropane	UG/KG	0	0%		0	0	5		5 U				
1,3-Dichlorobenzene	UG/KG	0	0%	1600	0	0	52	5.7 U	5 UJ	6 U	5.8 U	5.7 U	5.7 U
1,3-Dichloropropane	UG/KG	0	0%		0	0	48	5.7 U		6 U	5.8 U	5.7 U	5.7 U
1,4-Dichlorobenzene	UG/KG	0	0%	8500	0	0	52	5.7 U	5 UJ	6 U	5.8 U	5.7 U	5.7 U
Acetone	UG/KG	69	25%	200	0	13	53	23 U	11 NJ	24 U	23 U	23 U	23 U
Benzene	UG/KG	0	0%	60	0	0	53	5.7 U	5 U	6 U	5.8 U	5.7 U	5.7 U
Bromodichloromethane	UG/KG	0	0%		0	0	5		5 U				
Bromoform	UG/KG	0	0%		0	0	5		5 U				
Carbon disulfide	UG/KG	0	0%	2700	0	0	53	5.7 U	5 U	6 U	5.8 U	5.7 U	5.7 U
Carbon tetrachloride	UG/KG	0	0%	600	0	0	53	5.7 U	5 U	6 U	5.8 U	5.7 U	5.7 U
Chlorobenzene	UG/KG	0	0%	1700	0	0	53	5.7 U	5 U	6 U	5.8 U	5.7 U	5.7 U
Chlorodibromomethane	UG/KG	0	0%		0	0	53	5.7 U	5 U	6 U	5.8 U	5.7 U	5.7 U
Chloroethane	UG/KG	0	0%	1900	0	0	53	11 U	5 U	12 U	12 U	11 U	11 U
Chloroform	UG/KG	0	0%	300	0	0	53	5.7 U	5 U	6 U	5.8 U	5.7 U	5.7 U
Cis-1,2-Dichloroethene	UG/KG	0	0%		0	0	5		5 U				
Cis-1,3-Dichloropropene	UG/KG	0	0%		0	0	5		5 U				
Cyclohexane	UG/KG	0	0%		0	0	5		5 U				
Dichlorodifluoromethane	UG/KG	0	0%		0	0	5		5 U				
Ethyl benzene	UG/KG	0	0%	5500	0	0	53	5.7 U	5 U	6 U	5.8 U	5.7 U	5.7 U
Isopropylbenzene	UG/KG	0	0%		0	0	5		5 U				
Meta/Para Xylene	UG/KG	2.3	4%		0	2	48	5.7 U		6 U	5.8 U	5.7 U	5.7 U
Methyl Acetate	UG/KG	0	0%		0	0	5		5 U				
Methyl Tertbutyl Ether	UG/KG	0	0%		0	0	5		5 U				
Methyl bromide	UG/KG	0	0%		0	0	5		5 U				
Methyl butyl ketone	UG/KG	0	0%		0	0	5		5 U				
Methyl chloride	UG/KG	0	0%		0	0	5		5 U				
Methyl cyclohexane	UG/KG	0	0%		0	0	5		5 U				
Methyl ethyl ketone	UG/KG	7	9%	300	0	5	53	11 U	5 U	12 U	12 U	11 U	11 U
Methyl isobutyl ketone	UG/KG	0	0%	1000	0	0	53	11 U	5 U	12 U	12 U	11 U	11 U
Methylene chloride	UG/KG	3.45	2%	100	0	1	53	5.7 U	5 U	6 U	5.8 U	5.7 U	5.7 U
Ortho Xylene	UG/KG	1.9	10%		0	5	48	5.7 U		6 U	5.8 U	5.7 U	5.7 U
Styrene	UG/KG	0	0%		0	0	5		5 U				
Tetrachloroethene	UG/KG	6.7	6%	1400	0	3	53	5.7 U	5 U	6 U	5.8 U	5.7 U	5.7 U
Toluene	UG/KG	0	0%	1500	0	0	53	5.7 U	5 U	6 U	5.8 U	5.7 U	5.7 U
Total Xylenes	UG/KG	3	20%	1200	0	1	5		5 UJ				
Trans-1,2-Dichloroethene	UG/KG	0	0%	300	0	0	53	5.7 U	5 U	6 U	5.8 U	5.7 U	5.7 U

**Table A-6
SOIL SAMPLE RESULTS
SEAD-59 STOCKPILE
SEAD-59 and SEAD-71 Phase II RI Report
Seneca Army Depot Activity**

Facility	Location ID	Matrix	Sample ID	Sample Depth to Top of Sample	Sample Depth to Bottom of Sample	Sample Date	QC Code	Study ID	SEAD-59	SEAD-59	SEAD-59	SEAD-59	SEAD-59	SEAD-59	
									WS-59-01-013-2	WS-59-01-014-5	WS-59-01-015-14	WS-59-01-015-15	WS-59-01-015-16	WS-59-01-015-17	
Parameter	Units	Maximum Value	Frequency of Detection	NYSDEC TAGM Level	Number of Exceedances	Number of Times Detected	Number of Sample Analyses	SEAD-59	SEAD-59	SEAD-59	SEAD-59	SEAD-59	SEAD-59		
								SOIL	SOIL	SOIL	SOIL	SOIL	SOIL		
								WS-59-01-013-2	WS-59-01-014-5	WS-59-01-015-14	WS-59-01-015-15	WS-59-01-015-16	WS-59-01-015-17		
								0	0	0	0	0	0		
								0	0	0	0	0	0		
								5/6/2004	5/6/2004	5/6/2004	5/6/2004	5/6/2004	5/6/2004		
								SA	SA	SA	SA	SA	SA		
								ENSR IRM	ENSR IRM	ENSR IRM	ENSR IRM	ENSR IRM	ENSR IRM		
								1	1	1	1	1	1		
								Value (Q)	Value (Q)	Value (Q)	Value (Q)	Value (Q)	Value (Q)		
Trans-1,3-Dichloropropene	UG/KG	0	0%		0	0	5			5 U					
Trichloroethene	UG/KG	4.2	8%	700	0	4	53	5.7 U		5 U	6 U	5.8 U	5.7 U	5.7 U	
Trichlorofluoromethane	UG/KG	0	0%		0	0	5			5 U					
Vinyl chloride	UG/KG	0	0%	200	0	0	53	11 U		5 U	12 U	12 U	11 U	11 U	
Semivolatile Organics Compounds															
1,1'-Biphenyl	UG/KG	59	20%		0	1	5			370 U					
2,2'-oxybis(1-Chloropropane)	UG/KG	0	0%		0	0	5			370 U					
2,4,5-Trichlorophenol	UG/KG	0	0%	100	0	0	53	1900 U		930 U	2000 U	1900 U	1900 U	1900 U	
2,4,6-Trichlorophenol	UG/KG	0	0%		0	0	53	1900 U		370 U	2000 U	1900 U	1900 U	1900 U	
2,4-Dichlorophenol	UG/KG	0	0%	400	0	0	53	1900 U		370 U	2000 U	1900 U	1900 U	1900 U	
2,4-Dimethylphenol	UG/KG	0	0%		0	0	5			370 U					
2,4-Dinitrophenol	UG/KG	0	0%	200	0	0	53	9600 U		930 U	10000 U	9900 U	9700 U	9800 U	
2,4-Dinitrotoluene	UG/KG	0	0%		0	0	53	1900 U		370 U	2000 U	1900 U	1900 U	1900 U	
2,6-Dinitrotoluene	UG/KG	0	0%	1000	0	0	53	1900 U		370 U	2000 U	1900 U	1900 U	1900 U	
2-Chloronaphthalene	UG/KG	0	0%		0	0	5			370 U					
2-Chlorophenol	UG/KG	0	0%	800	0	0	53	1900 U		370 U	2000 U	1900 U	1900 U	1900 U	
2-Methylnaphthalene	UG/KG	1200	51%	36400	0	27	53	200 J		39 J	2000 U	1900 U	440 J	1900 U	
2-Methylphenol	UG/KG	0	0%	100	0	0	53	1900 U		370 U	2000 U	1900 U	1900 U	1900 U	
2-Nitroaniline	UG/KG	0	0%	430	0	0	53	9600 U		930 U	10000 U	9900 U	9700 U	9800 U	
2-Nitrophenol	UG/KG	0	0%	330	0	0	53	1900 U		370 U	2000 U	1900 U	1900 U	1900 U	
3,3'-Dichlorobenzidine	UG/KG	0	0%		0	0	53	1900 U		370 U	2000 U	1900 U	1900 U	1900 U	
3-Nitroaniline	UG/KG	0	0%	500	0	0	53	9600 U		930 U	10000 U	9900 U	9700 U	9800 U	
4,6-Dinitro-2-methylphenol	UG/KG	0	0%		0	0	5			930 U					
4-Bromophenyl phenyl ether	UG/KG	0	0%		0	0	5			370 U					
4-Chloro-3-methylphenol	UG/KG	0	0%	240	0	0	53	1900 U		370 U	2000 U	1900 U	1900 U	1900 U	
4-Chloroaniline	UG/KG	0	0%	220	0	0	53	1900 U		370 U	2000 U	1900 U	1900 U	1900 U	
4-Chlorophenyl phenyl ether	UG/KG	0	0%		0	0	5			370 U					
4-Methylphenol	UG/KG	0	0%	900	0	0	53	1900 U		370 U	2000 U	1900 U	1900 U	1900 U	
4-Nitroaniline	UG/KG	0	0%		0	0	5			930 U					
4-Nitrophenol	UG/KG	0	0%	100	0	0	53	9600 U		930 U	10000 U	9900 U	9700 U	9800 U	
Acenaphthene	UG/KG	2400	87%	50000	0	46	53	480 J		370 U	340 J	360 J	380 J	450 J	
Acenaphthylene	UG/KG	3500	98%	41000	0	52	53	1000 J		97 J	1500 J	1400 J	1300 J	1800 J	
Acetophenone	UG/KG	0	0%		0	0	5			370 U					
Aniline	UG/KG	0	0%		0	0	48	1900 U			2000 U	1900 U	1900 U	1900 U	
Anthracene	UG/KG	6600	100%	50000	0	53	53	1700 J		110 J	1600 J	1600 J	1500 J	2000	
Atrazine	UG/KG	0	0%		0	0	5			370 U					
Benzaldehyde	UG/KG	0	0%		0	0	5			370 U					
Benzo(a)anthracene	UG/KG	14000	100%	224	52	53	53	4600	370 NJ	4200	4000	3400	5400		
Benzo(a)pyrene	UG/KG	16000	100%	61	53	53	53	5100	430	4800	4300	4000	5400		
Benzo(b)fluoranthene	UG/KG	11000	100%	1100	46	53	53	3900	550	3600	3200	2700	3600		
Benzo(ghi)perylene	UG/KG	8000	100%	50000	0	53	53	3400	280 J	2900	2500	2400	2800		
Benzo(k)fluoranthene	UG/KG	13000	100%	1100	46	53	53	4000	200 J	3800	3300	3000	4300		
Benzoic Acid	UG/KG	0	0%	2700	0	0	48		9600 UJ		10000 UJ	9900 UJ	9700 UJ	9800 UJ	
Bis(2-Chloroethoxy)methane	UG/KG	0	0%		0	0	5			370 U					
Bis(2-Chloroethyl)ether	UG/KG	0	0%		0	0	5			370 U					
Bis(2-Ethylhexyl)phthalate	UG/KG	130	6%	50000	0	3	53	1900 U		110 J	2000 U	1900 U	1900 U	1900 U	
Butylbenzylphthalate	UG/KG	0	0%	50000	0	0	53	1900 UJ		370 U	2000 U	1900 U	1900 UJ	1900 UJ	
Caprolactam	UG/KG	0	0%		0	0	5			370 U					
Carbazole	UG/KG	1100	80%		0	4	5			42 J					

**Table A-6
SOIL SAMPLE RESULTS
SEAD-59 STOCKPILE
SEAD-59 and SEAD-71 Phase II RI Report
Seneca Army Depot Activity**

Facility	Location ID	Matrix	Sample ID	Sample Depth to Top of Sample	Sample Depth to Bottom of Sample	Sample Date	QC Code	Study ID	SEAD-59 WS-59-01-013-2	SEAD-59 WS-59-01-014-5	SEAD-59 WS-59-01-015-14	SEAD-59 WS-59-01-015-15	SEAD-59 WS-59-01-015-16	SEAD-59 WS-59-01-015-17	
Parameter	Units	Maximum Value	Frequency of Detection	NYSDEC TAGM Level	Number of Exceedances	Number of Times Detected	Number of Sample Analyses		Value (Q)	Value (Q)	Value (Q)	Value (Q)	Value (Q)	Value (Q)	
Chrysene	UG/KG	13000	100%	400	52	53	53		4700	420	4300	3900	3400	5300	
Di-n-butylphthalate	UG/KG	0	0%	8100	0	0	53		1900 U	370 U	2000 U	1900 U	1900 U	1900 U	
Di-n-octylphthalate	UG/KG	0	0%	50000	0	0	53		1900 U	370 U	2000 U	1900 U	1900 U	1900 U	
Dibenz(a,h)anthracene	UG/KG	2900	98%	14	52	52	53		1100 J	73 J	880 J	780 J	770 J	890 J	
Dibenzofuran	UG/KG	1300	62%	6200	0	33	53		310 J	370 U	240 J	240 J	310 J	320 J	
Diethyl phthalate	UG/KG	0	0%	7100	0	0	53		1900 U	370 U	2000 U	1900 U	1900 U	1900 U	
Dimethylphthalate	UG/KG	0	0%	2000	0	0	53		1900 U	370 U	2000 U	1900 U	1900 U	1900 U	
Fluoranthene	UG/KG	29000	100%	50000	0	53	53		7800	660	7700	7000	5700	10000	
Fluorene	UG/KG	3100	89%	50000	0	47	53		690 J	370 U	490 J	570 J	690 J	740 J	
Hexachlorobenzene	UG/KG	0	0%	410	0	0	53		1900 U	370 U	2000 U	1900 U	1900 U	1900 U	
Hexachlorobutadiene	UG/KG	0	0%	0	0	0	53		1900 U	370 U	2000 U	1900 U	1900 U	1900 U	
Hexachlorocyclopentadiene	UG/KG	0	0%	0	0	0	5		370 U	370 U	370 U	370 U	370 U	370 U	
Hexachloroethane	UG/KG	0	0%	0	0	0	53		1900 U	370 U	2000 U	1900 U	1900 U	1900 U	
Indeno(1,2,3-cd)pyrene	UG/KG	8000	100%	3200	19	53	53		3200 J	290 J	2600 J	2300 J	2200 J	2600 J	
Isophorone	UG/KG	0	0%	4400	0	0	53		1900 U	370 U	2000 U	1900 U	1900 U	1900 U	
N-Nitrosodiphenylamine	UG/KG	0	0%	0	0	0	5		370 U	370 U	370 U	370 U	370 U	370 U	
N-Nitrosodipropylamine	UG/KG	0	0%	0	0	0	5		370 U	370 U	370 U	370 U	370 U	370 U	
Naphthalene	UG/KG	1200	62%	13000	0	33	53		290 J	46 J	2000 U	1900 U	520 J	220 NJ	
Nitrobenzene	UG/KG	0	0%	200	0	0	53		1900 U	370 U	2000 U	1900 U	1900 U	1900 U	
Pentachlorophenol	UG/KG	660	2%	1000	0	1	53		9600 U	660 J	10000 U	9900 U	9700 U	9800 U	
Phenanthrene	UG/KG	17000	100%	50000	0	53	53		4500	250 J	4800	4400	4200	5100	
Phenol	UG/KG	0	0%	30	0	0	53		1900 U	370 U	2000 U	1900 U	1900 U	1900 U	
Pyrene	UG/KG	22000	100%	50000	0	53	53		7800	650	8200	7400	6600 J	10000 J	
Pyridine	UG/KG	0	0%	0	0	0	48		9600 U		10000 U	9900 U	9700 U	9800 U	
Pesticides/PCBs															
4,4'-DDD	UG/KG	450	62%	2900	0	33	53		34 J	24	450	36	21 J	76	
4,4'-DDE	UG/KG	230	62%	2100	0	33	53		43	49	86 J	31 J	19 U	61 J	
4,4'-DDT	UG/KG	520	70%	2100	0	37	53		33 J	45	520	55	22 J	60 J	
Aldrin	UG/KG	0	0%	41	0	0	53		9.6 U	1.9 U	10 U	9.9 U	9.7 U	9.8 U	
Alpha-BHC	UG/KG	4.4	2%	110	0	1	53		9.6 U	1.9 U	10 U	9.9 U	9.7 U	9.8 U	
Alpha-Chlordane	UG/KG	27	11%	0	0	6	53		9.6 U	3.4	10 U	9.9 U	9.7 U	9.8 U	
Beta-BHC	UG/KG	13	2%	200	0	1	53		9.6 U	13 NJ	10 U	9.9 U	9.7 U	9.8 U	
Delta-BHC	UG/KG	0	0%	300	0	0	53		9.6 U	1.9 U	10 U	9.9 U	9.7 U	9.8 U	
Dieldrin	UG/KG	0	0%	44	0	0	53		19 U	3.7 U	20 U	19 U	19 U	19 U	
Endosulfan I	UG/KG	0	0%	900	0	0	53		9.6 U	1.9 U	10 U	9.9 U	9.7 U	9.8 U	
Endosulfan II	UG/KG	0	0%	900	0	0	53		19 U	3.7 U	20 U	19 U	19 U	19 U	
Endosulfan sulfate	UG/KG	0	0%	1000	0	0	53		19 U	3.7 U	20 U	19 U	19 U	19 U	
Endrin	UG/KG	0	0%	100	0	0	53		19 U	3.7 U	20 U	19 U	19 U	19 U	
Endrin aldehyde	UG/KG	0	0%	0	0	0	53		19 U	3.7 U	20 U	19 U	19 U	19 U	
Endrin ketone	UG/KG	15	2%	0	0	1	53		19 U	3.7 U	20 U	19 U	19 U	19 U	

Table A-6
SOIL SAMPLE RESULTS
SEAD-59 STOCKPILE
SEAD-59 and SEAD-71 Phase II RI Report
Seneca Army Depot Activity

Facility	SEAD-59						SEAD-59						
Location ID	WS-59-01-013-2		WS-59-01-014-5		WS-59-01-015-14		WS-59-01-015-15		WS-59-01-015-16		WS-59-01-015-17		
Matrix	SOIL						SOIL						
Sample ID	WS-59-01-013-2		WS-59-01-014-5		WS-59-01-015-14		WS-59-01-015-15		WS-59-01-015-16		WS-59-01-015-17		
Sample Depth to Top of Sample	0		0		0		0		0		0		
Sample Depth to Bottom of Sample	0		0		0		0		0		0		
Sample Date	5/6/2004		5/6/2004		5/6/2004		5/6/2004		5/6/2004		5/6/2004		
QC Code	SA		SA		SA		SA		SA		SA		
Study ID	ENSR IRM		ENSR IRM		ENSR IRM		ENSR IRM		ENSR IRM		ENSR IRM		
	Maximum	Frequency	NYSDEC	Number	Number	Number	Value	Value	Value	Value	Value	Value	
Parameter	Units	of	TAGM	of	of	of	(Q)	(Q)	(Q)	(Q)	(Q)	(Q)	
	Value	Detection	Level	Exceedances	Times	Sample							
					Detected	Analyses							
Gamma-BHC/Lindane	UG/KG	0	0%	60	0	53	9.6 U	9.6 U	10 U	9.9 U	9.7 U	9.8 U	
Gamma-Chlordane	UG/KG	21	9%	540	0	53	9.6 U	1.9 U	10 U	9.9 U	9.7 U	9.8 U	
Heptachlor	UG/KG	0	0%	100	0	53	9.6 U	1.9 U	10 U	9.9 U	9.7 U	9.8 U	
Heptachlor epoxide	UG/KG	0	0%	20	0	53	9.6 U	1.9 U	10 U	9.9 U	9.7 U	9.8 U	
Methoxychlor	UG/KG	0	0%	0	0	53	96 U	19 U	100 U	99 U	97 U	98 U	
Toxaphene	UG/KG	0	0%	0	0	53	190 U	190 U	200 U	190 U	190 U	190 U	
Aroclor-1016	UG/KG	0	0%	0	0	53	37 U	37 U	39 U	38 U	38 U	38 U	
Aroclor-1221	UG/KG	0	0%	0	0	53	37 U	37 U	39 U	38 U	38 U	38 U	
Aroclor-1232	UG/KG	0	0%	0	0	53	37 U	37 U	39 U	38 U	38 U	38 U	
Aroclor-1242	UG/KG	0	0%	0	0	53	37 U	37 U	39 U	38 U	38 U	38 U	
Aroclor-1248	UG/KG	0	0%	0	0	53	37 U	37 U	39 U	38 U	38 U	38 U	
Aroclor-1254	UG/KG	0	0%	10000	0	53	37 U	37 U	39 U	38 U	38 U	38 U	
Aroclor-1260	UG/KG	0	0%	10000	0	53	37 U	37 U	39 U	38 U	38 U	38 U	
Metals													
Aluminum	MG/KG	13400	100%	19300	0	53	12000	10700 J	11400	10100	12100	11000	
Antimony	MG/KG	43.9	21%	5.9	3	11	53	3.3 U	1.7 J	43.9 J	3.7 J	12 J	3.4 U
Arsenic	MG/KG	7.3	100%	8.2	0	53	53	5	7.3 J	4.5 J	4.1 J	4.5	4.9
Barium	MG/KG	135	100%	300	0	53	53	97.6	101 J	135	93.3	91.6	133
Beryllium	MG/KG	0.69	100%	1.1	0	53	53	0.38	0.58	0.32	0.32	0.4	0.3
Cadmium	MG/KG	1.2	98%	2.3	0	52	53	0.52 J	0.54	0.89	0.36 J	0.55 J	0.57 J
Calcium	MG/KG	100000	100%	121000	0	53	53	42900	41300 J	38300	69600	76800	96100
Chromium	MG/KG	35	100%	29.6	3	53	53	22	18.2 J	19.9 J	15.5 J	27.7	18.1
Cobalt	MG/KG	13.9	100%	30	0	53	53	11.1	10.1 J	10.1	8.8	11.1	9.8
Copper	MG/KG	51.8	100%	33	14	53	53	29.5	25 J	24.8 J	22.6 J	36.2 J	32.3
Iron	MG/KG	26500	100%	36500	0	53	53	23200	24500 J	20800	18600	22700	19800
Lead	MG/KG	1440	100%	24.8	51	53	53	44.1 J	33.4 J	195 J	31.2 J	149 J	61.6 J
Magnesium	MG/KG	26600	100%	21500	1	53	53	9440	7060 J	7250	6890	7820	15600
Manganese	MG/KG	1220	100%	1060	2	53	53	528	632 J	471	646	591	536
Mercury	MG/KG	0.52	100%	0.1	9	53	53	0.05	0.07 J	0.06	0.06	0.04	0.05
Nickel	MG/KG	56.6	100%	49	1	53	53	34.2	29.1 J	27.5 J	23.3 J	31.6	26.5
Potassium	MG/KG	1580	100%	2380	0	53	53	1320	1100 J	1070	949	1260	1200
Selenium	MG/KG	0.72	4%	2	0	2	53	0.72 J	0.43 U	1.2 UJ	1.1 UJ	0.55 U	0.57 U
Silver	MG/KG	4.7	17%	0.75	6	9	53	0.55 U	0.74	0.57 U	0.55 U	0.55 U	0.57 U
Sodium	MG/KG	525	100%	172	23	53	53	191 J	294 J	92.4	106	110	131
Thallium	MG/KG	0.99	51%	0.7	12	27	53	0.76 J	0.22 U	0.88 J	0.98 J	0.99 J	0.95 J
Vanadium	MG/KG	35.4	100%	150	0	53	53	22.3	19 J	19.3	17.3	20.3	21.3
Zinc	MG/KG	185	100%	110	6	53	53	98.4 J	78.1 J	127 J	82.7 J	97.4 J	81.9 J

Note(s):
(1) - NYSDEC Technical and Administrative Guidance Memorandum (TAGM) HWR-94-4046, Revised January 24, 1994
(2) - Sample-Duplicate pairs are presented as a combined sample in this table.
Their Sample ID is a combination of the sample and the sample duplicate Sample ID (for example FD-59-CL-05/CL-59-01-WS1)
In addition, the 'QC Code' field is labeled 'SADU'

U = compound was not detected
J = the reported value is an estimated concentration
UJ = the compound was not detected; the associated reporting limit is approximate
R = the data was rejected in the data validating process
NJ = compound was "tentatively identified" and the associated numerical value is approximate

Table A-6
SOIL SAMPLE RESULTS
SEAD-59 STOCKPILE
SEAD-59 and SEAD-71 Phase II RI Report
Seneca Army Depot Activity

Facility	SEAD-59	SEAD-59	SEAD-59	SEAD-59	SEAD-59	SEAD-59							
Location ID	WS-59-01-015-20	WS-59-01-015-3	WS-59-01-015-4	WS-59-01-015-8	WS-59-01-016-1	WS-59-01-016-10							
Matrix	SOIL	SOIL	SOIL	SOIL	SOIL	SOIL							
Sample ID	WS-59-01-015-20	WS-59-01-015-3	WS-59-01-015-4	WS-59-01-015-8	WS-59-01-016-1	WS-59-01-016-10							
Sample Depth to Top of Sample	0	0	0	0	0	0							
Sample Depth to Bottom of Sample	0	0	0	0	0	0							
Sample Date	5/6/2004	5/6/2004	5/6/2004	5/6/2004	5/6/2004	5/6/2004							
QC Code	SA	SA	SA	SA	SA	SA							
Study ID	ENSR IRM	ENSR IRM	ENSR IRM	ENSR IRM	ENSR IRM	ENSR IRM							
	1	1	1	1	1	1							
Parameter	Units	Maximum Value	Frequency of Detection	NYSDEC TAGM Level	Number of Exceedances	Number of Times Detected	Number of Sample Analyses	Value (Q)	Value (Q)	Value (Q)	Value (Q)	Value (Q)	Value (Q)
Volatile Organic Compounds													
1,1,1-Trichloroethane	UG/KG	0	0%	800	0	0	53	5.7 U	6.1 U	5.9 U	5.8 U	5.7 U	5.8 U
1,1,2,2-Tetrachloroethane	UG/KG	0	0%	600	0	0	52	5.7 U	6.1 U	5.9 U	5.8 U	5.7 U	5.8 U
1,1,2-Trichloro-1,2,2-Trifluoroethane	UG/KG	1.5	2%		0	1	53	5.7 U	6.1 U	5.9 U	5.8 U	5.7 U	5.8 U
1,1,2-Trichloroethane	UG/KG	0	0%		0	0	5						
1,1-Dichloroethane	UG/KG	0	0%	200	0	0	53	5.7 U	6.1 U	5.9 U	5.8 U	5.7 U	5.8 U
1,1-Dichloroethene	UG/KG	1	2%	400	0	1	53	5.7 U	6.1 U	5.9 U	5.8 U	5.7 U	5.8 U
1,2,3-Trichloropropane	UG/KG	0	0%		0	0	47	5.7 U	6.1 U	5.9 U	5.8 U	5.7 U	5.8 U
1,2,4-Trichlorobenzene	UG/KG	0	0%	3400	0	0	52	5.7 U	6.1 U	5.9 U	5.8 U	5.7 U	5.8 U
1,2-Dibromo-3-chloropropane	UG/KG	0	0%		0	0	5						
1,2-Dibromoethane	UG/KG	0	0%		0	0	5						
1,2-Dichlorobenzene	UG/KG	0	0%	7900	0	0	52	5.7 U	6.1 U	5.9 U	5.8 U	5.7 U	5.8 U
1,2-Dichloroethane	UG/KG	0	0%	100	0	0	53	5.7 U	6.1 U	5.9 U	5.8 U	5.7 U	5.8 U
1,2-Dichloropropane	UG/KG	0	0%		0	0	5						
1,3-Dichlorobenzene	UG/KG	0	0%	1600	0	0	52	5.7 U	6.1 U	5.9 U	5.8 U	5.7 U	5.8 U
1,3-Dichloropropane	UG/KG	0	0%		0	0	48	5.7 U	6.1 U	5.9 U	5.8 U	5.7 U	5.8 U
1,4-Dichlorobenzene	UG/KG	0	0%	8500	0	0	52	5.7 U	6.1 U	5.9 U	5.8 U	5.7 U	5.8 U
Acetone	UG/KG	69	25%	200	0	13	53	23 U	25 U	24 U	23 U	23 U	20 J
Benzene	UG/KG	0	0%	60	0	0	53	5.7 U	6.1 U	5.9 U	5.8 U	5.7 U	5.8 U
Bromodichloromethane	UG/KG	0	0%		0	0	5						
Bromoform	UG/KG	0	0%		0	0	5						
Carbon disulfide	UG/KG	0	0%	2700	0	0	53	5.7 U	6.1 U	5.9 U	5.8 U	5.7 U	5.8 U
Carbon tetrachloride	UG/KG	0	0%	600	0	0	53	5.7 U	6.1 U	5.9 U	5.8 U	5.7 U	5.8 U
Chlorobenzene	UG/KG	0	0%	1700	0	0	53	5.7 U	6.1 U	5.9 U	5.8 U	5.7 U	5.8 U
Chlorodibromomethane	UG/KG	0	0%		0	0	53	5.7 U	6.1 U	5.9 U	5.8 U	5.7 U	5.8 U
Chloroethane	UG/KG	0	0%	1900	0	0	53	11 U	12 U	12 U	12 U	11 U	12 U
Chloroform	UG/KG	0	0%	300	0	0	53	5.7 U	6.1 U	5.9 U	5.8 U	5.7 U	5.8 U
Cis-1,2-Dichloroethene	UG/KG	0	0%		0	0	5						
Cis-1,3-Dichloropropene	UG/KG	0	0%		0	0	5						
Cyclohexane	UG/KG	0	0%		0	0	5						
Dichlorodifluoromethane	UG/KG	0	0%		0	0	5						
Ethyl benzene	UG/KG	0	0%	5500	0	0	53	5.7 U	6.1 U	5.9 U	5.8 U	5.7 U	5.8 U
Isopropylbenzene	UG/KG	0	0%		0	0	5						
Meta/Para Xylene	UG/KG	2.3	4%		0	2	48	5.7 U	6.1 U	5.9 U	5.8 U	5.7 U	2.2 J
Methyl Acetate	UG/KG	0	0%		0	0	5						
Methyl Tertbutyl Ether	UG/KG	0	0%		0	0	5						
Methyl bromide	UG/KG	0	0%		0	0	5						
Methyl butyl ketone	UG/KG	0	0%		0	0	5						
Methyl chloride	UG/KG	0	0%		0	0	5						
Methyl cyclohexane	UG/KG	0	0%		0	0	5						
Methyl ethyl ketone	UG/KG	7	9%	300	0	5	53	11 U	12 U	12 U	12 U	11 U	12 U
Methyl isobutyl ketone	UG/KG	0	0%	1000	0	0	53	11 U	12 U	12 U	12 U	11 U	12 U
Methylene chloride	UG/KG	3.45	2%	100	0	1	53	5.7 U	6.1 U	5.9 U	5.8 U	5.7 U	5.8 U
Ortho Xylene	UG/KG	1.9	10%		0	5	48	5.7 U	6.1 U	5.9 U	5.8 U	5.7 U	1.9 J
Styrene	UG/KG	0	0%		0	0	5						
Tetrachloroethene	UG/KG	6.7	6%	1400	0	3	53	5.7 U	6.1 U	5.9 U	5.8 U	5.7 U	5.8 U
Toluene	UG/KG	0	0%	1500	0	0	53	5.7 U	6.1 U	5.9 U	5.8 U	5.7 U	5.8 U
Total Xylenes	UG/KG	3	20%	1200	0	1	5						
Trans-1,2-Dichloroethene	UG/KG	0	0%	300	0	0	53	5.7 U	6.1 U	5.9 U	5.8 U	5.7 U	5.8 U

**Table A-6
SOIL SAMPLE RESULTS
SEAD-59 STOCKPILE
SEAD-59 and SEAD-71 Phase II RI Report
Seneca Army Depot Activity**

Facility	SEAD-59	SEAD-59	SEAD-59	SEAD-59	SEAD-59	SEAD-59							
Location ID	WS-59-01-015-20	WS-59-01-015-3	WS-59-01-015-4	WS-59-01-015-8	WS-59-01-016-1	WS-59-01-016-10							
Matrix	SOIL	SOIL	SOIL	SOIL	SOIL	SOIL							
Sample ID	WS-59-01-015-20	WS-59-01-015-3	WS-59-01-015-4	WS-59-01-015-8	WS-59-01-016-1	WS-59-01-016-10							
Sample Depth to Top of Sample	0	0	0	0	0	0							
Sample Depth to Bottom of Sample	0	0	0	0	0	0							
Sample Date	5/6/2004	5/6/2004	5/6/2004	5/6/2004	5/6/2004	5/6/2004							
QC Code	SA	SA	SA	SA	SA	SA							
Study ID	ENSR IRM	ENSR IRM	ENSR IRM	ENSR IRM	ENSR IRM	ENSR IRM							
	1	1	1	1	1	1							
	Value (Q)	Value (Q)	Value (Q)	Value (Q)	Value (Q)	Value (Q)							
Parameter	Units	Maximum Value	Frequency of Detection	NYSDEC TAGM Level	Number of Exceedances	Number of Times Detected	Number of Sample Analyses	Value (Q)	Value (Q)	Value (Q)	Value (Q)	Value (Q)	Value (Q)
Trans-1,3-Dichloropropene	UG/KG	0	0%		0	0	5						
Trichloroethene	UG/KG	4.2	8%	700	0	4	53	5.7 U	6.1 U	5.9 U	5.8 U	5.7 U	5.8 U
Trichlorofluoromethane	UG/KG	0	0%		0	0	5						
Vinyl chloride	UG/KG	0	0%	200	0	0	53	11 U	12 U	12 U	12 U	11 U	12 U
Semivolatile Organics Compounds													
1,1'-Biphenyl	UG/KG	59	20%		0	1	5						
2,2'-oxybis(1-Chloropropane)	UG/KG	0	0%		0	0	5						
2,4,5-Trichlorophenol	UG/KG	0	0%	100	0	0	53	1900 U	410 U	1900 U	1900 U	1900 U	1900 U
2,4,6-Trichlorophenol	UG/KG	0	0%		0	0	53	1900 U	410 U	1900 U	1900 U	1900 U	1900 U
2,4-Dichlorophenol	UG/KG	0	0%	400	0	0	53	1900 U	410 U	1900 U	1900 U	1900 U	1900 U
2,4-Dimethylphenol	UG/KG	0	0%		0	0	5						
2,4-Dinitrophenol	UG/KG	0	0%	200	0	0	53	9600 U	2100 U	10000 U	9900 U	9800 U	9900 UJ
2,4-Dinitrotoluene	UG/KG	0	0%		0	0	53	1900 U	410 U	1900 U	1900 U	1900 U	1900 U
2,6-Dinitrotoluene	UG/KG	0	0%	1000	0	0	53	1900 U	410 U	1900 U	1900 U	1900 U	1900 U
2-Chloronaphthalene	UG/KG	0	0%		0	0	5						
2-Chlorophenol	UG/KG	0	0%	800	0	0	53	1900 U	410 U	1900 U	1900 U	1900 U	1900 U
2-Methylnaphthalene	UG/KG	1200	51%	36400	0	27	53	210 J	140 J	1900 U	1900 U	230 J	1900 U
2-Methylphenol	UG/KG	0	0%	100	0	0	53	1900 U	410 U	1900 U	1900 U	1900 U	1900 U
2-Nitroaniline	UG/KG	0	0%	430	0	0	53	9600 U	2100 U	10000 U	9900 U	9800 U	9900 U
2-Nitrophenol	UG/KG	0	0%	330	0	0	53	1900 U	410 U	1900 U	1900 U	1900 U	1900 U
3,3'-Dichlorobenzidine	UG/KG	0	0%		0	0	53	1900 U	410 U	1900 U	1900 U	1900 U	1900 U
3-Nitroaniline	UG/KG	0	0%	500	0	0	53	9600 U	2100 U	10000 U	9900 U	9800 U	9900 U
4,6-Dinitro-2-methylphenol	UG/KG	0	0%		0	0	5						
4-Bromophenyl phenyl ether	UG/KG	0	0%		0	0	5						
4-Chloro-3-methylphenol	UG/KG	0	0%	240	0	0	53	1900 U	410 U	1900 U	1900 U	1900 U	1900 U
4-Chloroaniline	UG/KG	0	0%	220	0	0	53	1900 U	410 U	1900 U	1900 U	1900 U	1900 U
4-Chlorophenyl phenyl ether	UG/KG	0	0%		0	0	5						
4-Methylphenol	UG/KG	0	0%	900	0	0	53	1900 U	410 U	1900 U	1900 U	1900 U	1900 U
4-Nitroaniline	UG/KG	0	0%		0	0	5						
4-Nitrophenol	UG/KG	0	0%	100	0	0	53	9600 U	2100 U	10000 U	9900 U	9800 U	9900 U
Acenaphthene	UG/KG	2400	87%	50000	0	46	53	520 J	46 J	1900 U	1900 U	1100 J	500 J
Acenaphthylene	UG/KG	3500	98%	41000	0	52	53	2000	130 J	1400 J	1200 J	1600 J	1200 J
Acetophenone	UG/KG	0	0%		0	0	5						
Aniline	UG/KG	0	0%		0	0	48	1900 U	410 U	1900 U	1900 U	1900 U	1900 U
Anthracene	UG/KG	6600	100%	50000	0	53	53	2300	120 J	990 J	910 J	5200	1800 J
Atrazine	UG/KG	0	0%		0	0	5						
Benzaldehyde	UG/KG	0	0%		0	0	5						
Benzo(a)anthracene	UG/KG	14000	100%	224	52	53	53	5600	460	4200	3700	8200	3800
Benzo(a)pyrene	UG/KG	16000	100%	61	53	53	53	5900	550	6200	4200	7600	3600
Benzo(b)fluoranthene	UG/KG	11000	100%	1100	46	53	53	4500	410	4700	3200	6400	2500
Benzo(ghi)perylene	UG/KG	8000	100%	50000	0	53	53	2700	400 J	4200	2600	3400	2100
Benzo(k)fluoranthene	UG/KG	13000	100%	1100	46	53	53	4900	420	4700	3400	6700	2800
Benzoic Acid	UG/KG	0	0%	2700	0	0	48	9600 U	2100 UJ	10000 U	9900 U	9800 U	9900 U
Bis(2-Chloroethoxy)methane	UG/KG	0	0%		0	0	5						
Bis(2-Chloroethyl)ether	UG/KG	0	0%		0	0	5						
Bis(2-Ethylhexyl)phthalate	UG/KG	130	6%	50000	0	3	53	1900 U	410 U	1900 U	1900 U	1900 U	1900 U
Butylbenzylphthalate	UG/KG	0	0%	50000	0	0	53	1900 UJ	410 UJ	1900 U	1900 U	1900 UJ	1900 U
Caprolactam	UG/KG	0	0%		0	0	5						
Carbazole	UG/KG	1100	80%		0	4	5						

Table A-6
SOIL SAMPLE RESULTS
SEAD-59 STOCKPILE
SEAD-59 and SEAD-71 Phase II RI Report
Seneca Army Depot Activity

Facility	Location ID	Matrix	Sample ID	Sample Depth to Top of Sample	Sample Depth to Bottom of Sample	Sample Date	QC Code	Study ID	SEAD-59 WS-59-01-015-20	SEAD-59 WS-59-01-015-3	SEAD-59 WS-59-01-015-4	SEAD-59 WS-59-01-015-8	SEAD-59 WS-59-01-016-1	SEAD-59 WS-59-01-016-10	
Parameter	Units	Maximum Value	Frequency of Detection	NYSDEC TAGM Level	Number of Exceedances	Number of Times Detected	Number of Sample Analyses		Value (Q)	Value (Q)	Value (Q)	Value (Q)	Value (Q)	Value (Q)	
Chrysene	UG/KG	13000	100%	400	52	53	53		5400	480	4300	3600	9000	3700	
Di-n-butylphthalate	UG/KG	0	0%	8100	0	0	53		1900 U	410 U	1900 U	1900 U	1900 U	1900 U	
Di-n-octylphthalate	UG/KG	0	0%	50000	0	0	53		1900 U	410 U	1900 U	1900 U	1900 U	1900 U	
Dibenz(a,h)anthracene	UG/KG	2900	98%	14	52	53	53		1000 J	120 J	1300 J	840 J	1200 J	730 J	
Dibenzofuran	UG/KG	1300	62%	6200	0	33	53		330 J	410 U	1900 U	1900 U	700 J	320 J	
Diethyl phthalate	UG/KG	0	0%	7100	0	0	53		1900 U	410 U	1900 U	1900 U	1900 U	1900 U	
Dimethylphthalate	UG/KG	0	0%	2000	0	0	53		1900 U	410 U	1900 U	1900 U	1900 U	1900 U	
Fluoranthene	UG/KG	29000	100%	50000	0	53	53		11000	680	5000	6100	18000	7600	
Fluorene	UG/KG	3100	89%	50000	0	47	53		800 J	51 NJ	1900 U	250 NJ	1300 J	780 J	
Hexachlorobenzene	UG/KG	0	0%	410	0	0	53		1900 U	410 U	1900 U	1900 U	1900 U	1900 U	
Hexachlorobutadiene	UG/KG	0	0%	0	0	0	53		1900 U	410 U	1900 U	1900 U	1900 U	1900 U	
Hexachlorocyclopentadiene	UG/KG	0	0%	0	0	0	5								
Hexachloroethane	UG/KG	0	0%	0	0	0	53		1900 U	410 U	1900 U	1900 U	1900 U	1900 U	
Indeno(1,2,3-cd)pyrene	UG/KG	8000	100%	3200	19	53	53		2700 J	360 J	3800 J	2400 J	3400 J	2000 J	
Isophorone	UG/KG	0	0%	4400	0	0	53		1900 U	410 U	1900 U	1900 U	1900 U	1900 U	
N-Nitrosodiphenylamine	UG/KG	0	0%	0	0	0	5								
N-Nitrosodipropylamine	UG/KG	0	0%	0	0	0	5								
Naphthalene	UG/KG	1200	62%	13000	0	33	53		280 NJ	54 J	1900 U	1900 U	210 J	250 J	
Nitrobenzene	UG/KG	0	0%	200	0	0	53		1900 U	410 U	1900 U	1900 U	1900 U	1900 U	
Pentachlorophenol	UG/KG	660	2%	1000	0	1	53		9600 U	2100 U	10000 U	9900 U	9800 U	9900 U	
Phenanthrene	UG/KG	17000	100%	50000	0	53	53		5600	280 J	1400 J	1900 J	6100	4300	
Phenol	UG/KG	0	0%	30	0	0	53		1900 U	410 U	1900 U	1900 U	1900 U	1900 U	
Pyrene	UG/KG	22000	100%	50000	0	53	53		9400 J	730	5200	6000	15000 J	6800	
Pyridine	UG/KG	0	0%	0	0	0	48		9600 U	2100 U	10000 U	9900 U	9800 U	9900 U	
Pesticides/PCBs															
4,4'-DDD	UG/KG	450	62%	2900	0	33	53		19 U	20 U	19 U	19 U	95 U	96 U	
4,4'-DDE	UG/KG	230	62%	2100	0	33	53		19 U	20 U	19 U	19 U	95 U	96 U	
4,4'-DDT	UG/KG	520	70%	2100	0	37	53		19 U	20 U	19 U	27 J	95 U	96 U	
Aldrin	UG/KG	0	0%	41	0	0	53		9.6 U	10 U	10 U	9.9 U	49 U	50 U	
Alpha-BHC	UG/KG	4.4	2%	110	0	1	53		9.6 U	10 U	10 U	9.9 U	49 U	50 U	
Alpha-Chlordane	UG/KG	27	11%	0	0	6	53		9.6 U	10 U	10 U	9.9 U	49 U	50 U	
Beta-BHC	UG/KG	13	2%	200	0	1	53		9.6 U	10 U	10 U	9.9 U	49 U	50 U	
Delta-BHC	UG/KG	0	0%	300	0	0	53		9.6 U	10 U	10 U	9.9 U	49 U	50 U	
Dieldrin	UG/KG	0	0%	44	0	0	53		19 U	20 U	19 U	19 U	95 U	96 U	
Endosulfan I	UG/KG	0	0%	900	0	0	53		9.6 U	10 U	10 U	9.9 U	49 U	50 U	
Endosulfan II	UG/KG	0	0%	900	0	0	53		19 U	20 U	19 U	19 U	95 U	96 U	
Endosulfan sulfate	UG/KG	0	0%	1000	0	0	53		19 U	20 U	19 U	19 U	95 U	96 U	
Endrin	UG/KG	0	0%	100	0	0	53		19 U	20 U	19 U	19 U	95 U	96 U	
Endrin aldehyde	UG/KG	0	0%	0	0	0	53		19 U	20 U	19 U	19 U	95 U	96 U	
Endrin ketone	UG/KG	15	2%	0	0	1	53		19 U	20 U	19 U	19 U	95 U	96 U	

Table A-6
SOIL SAMPLE RESULTS
SEAD-59 STOCKPILE
SEAD-59 and SEAD-71 Phase II RI Report
Seneca Army Depot Activity

Facility	Location ID	Matrix	Sample ID	Sample Depth to Top of Sample	Sample Depth to Bottom of Sample	Sample Date	QC Code	Study ID	SEAD-59	SEAD-59	SEAD-59	SEAD-59	SEAD-59	SEAD-59
									WS-59-01-015-20	WS-59-01-015-3	WS-59-01-015-4	WS-59-01-015-8	WS-59-01-016-1	WS-59-01-016-10
Parameter	Units	Maximum Value	Frequency of Detection	NYSDEC TAGM Level	Number of Exceedances	Number of Times Detected	Number of Sample Analyses	ENSR IRM	ENSR IRM	ENSR IRM	ENSR IRM	ENSR IRM	ENSR IRM	
								1	1	1	1	1	1	
								Value (Q)	Value (Q)	Value (Q)	Value (Q)	Value (Q)	Value (Q)	
Gamma-BHC/Lindane	UG/KG	0	0%	60	0	53	53	9.6 U	10 U	10 U	9.9 U	49 U	50 U	
Gamma-Chlordane	UG/KG	21	9%	540	0	5	53	9.6 U	10 U	10 U	9.9 U	49 U	50 U	
Heptachlor	UG/KG	0	0%	100	0	0	53	9.6 U	10 U	10 U	9.9 U	49 U	50 U	
Heptachlor epoxide	UG/KG	0	0%	20	0	0	53	9.6 U	10 U	10 U	9.9 U	49 U	50 U	
Methoxychlor	UG/KG	0	0%		0	0	53	96 U	100 U	100 U	99 U	490 U	500 U	
Toxaphene	UG/KG	0	0%		0	0	53	190 U	200 U	190 U	190 U	950 U	960 U	
Aroclor-1016	UG/KG	0	0%		0	0	53	37 U	41 U	39 U	38 U	38 U	39 U	
Aroclor-1221	UG/KG	0	0%		0	0	53	37 U	41 U	39 U	38 U	38 U	39 U	
Aroclor-1232	UG/KG	0	0%		0	0	53	37 U	41 U	39 U	38 U	38 U	39 U	
Aroclor-1242	UG/KG	0	0%		0	0	53	37 U	41 U	39 U	38 U	38 U	39 U	
Aroclor-1248	UG/KG	0	0%		0	0	53	37 U	41 U	39 U	38 U	38 U	39 U	
Aroclor-1254	UG/KG	0	0%	10000	0	0	53	37 U	41 U	39 U	38 U	38 U	39 U	
Aroclor-1260	UG/KG	0	0%	10000	0	0	53	37 U	41 U	39 U	38 U	38 U	39 U	
Metals														
Aluminum	MG/KG	13400	100%	19300	0	53	53	12400	11400	10600	11100	10100	10500	
Antimony	MG/KG	43.9	21%	5.9	3	11	53	3.4 U	3.6 UJ	3.4 UJ	3.3 UJ	3.3 UJ	5.9 J	
Arsenic	MG/KG	7.3	100%	8.2	0	53	53	5.1	4.8	4.8	4.7	4.2	4	
Barium	MG/KG	135	100%	300	0	53	53	104	107	84.7	99.9	76.1	93.1	
Beryllium	MG/KG	0.69	100%	1.1	0	53	53	0.41	0.27	0.33	0.34	0.36	0.33	
Cadmium	MG/KG	1.2	98%	2.3	0	52	53	0.51 J	0.64	0.73	0.72	0.73	0.72	
Calcium	MG/KG	100000	100%	121000	0	53	53	66700	17600	29600	40500	59200	42500	
Chromium	MG/KG	35	100%	29.6	3	53	53	21.5	18.6	18.2	19.7	17.3	16.9	
Cobalt	MG/KG	13.9	100%	30	0	53	53	12.1	10.4	10.3	10	9.2	9.2	
Copper	MG/KG	51.8	100%	33	14	53	53	37.4	24.3	24.9	26.1	26.3 J	37.7 J	
Iron	MG/KG	26500	100%	36500	0	53	53	23700	23200	21900	21100	19800	19400	
Lead	MG/KG	1440	100%	24.8	51	53	53	65.4 J	20.5 J	27.8 J	39.7 J	41.9 J	1440 J	
Magnesium	MG/KG	26600	100%	21500	1	53	53	8980	4890	7020	7900	9270	8130	
Manganese	MG/KG	1220	100%	1060	2	53	53	557	734	467	513	567	489	
Mercury	MG/KG	0.52	100%	0.1	9	53	53	0.07	0.05	0.08	0.08	0.08	0.27	
Nickel	MG/KG	56.6	100%	49	1	53	53	34.3	27.7	29.8	28.5	27.3	25.1	
Potassium	MG/KG	1580	100%	2380	0	53	53	1290	1200	1140	1140	1150	1220	
Selenium	MG/KG	0.72	4%	2	0	2	53	0.57 U	0.61 UJ	0.56 UJ	0.55 UJ	0.56 U	0.56 U	
Silver	MG/KG	4.7	17%	0.75	6	9	53	0.57 U	0.61 UJ	0.56 UJ	0.55 UJ	0.56 U	0.56 U	
Sodium	MG/KG	525	100%	172	23	53	53	125	252	221	211	151	330	
Thallium	MG/KG	0.99	51%	0.7	12	27	53	0.85 J	0.94 J	0.65 J	0.55 U	0.56 U	0.56 J	
Vanadium	MG/KG	35.4	100%	150	0	53	53	22.9	18.7	18.7	19.3	18.2	18.9	
Zinc	MG/KG	185	100%	110	6	53	53	99.6 J	77.6 J	80.5 J	76.3 J	88.3 J	82.5 J	

Note(s):
(1) - NYSDEC Technical and Administrative Guidance Memorandum (TAGM) HWR-94-4046, Revised January 24, 1994
(2) - Sample-Duplicate pairs are presented as a combined sample in this table.
Their Sample ID is a combination of the sample and the sample duplicate Sample ID (for example FD-59-CL-05/CL-59-01-WS1)
In addition, the 'QC Code' field is labeled 'SADU'

U = compound was not detected
J = the reported value is an estimated concentration
UJ = the compound was not detected; the associated reporting limit is approximate
R = the data was rejected in the data validating process
NJ = compound was "tentatively identified" and the associated numerical value is approximate

Table A-6
SOIL SAMPLE RESULTS
SEAD-59 STOCKPILE
SEAD-59 and SEAD-71 Phase II RI Report
Seneca Army Depot Activity

Facility	SEAD-59	SEAD-59	SEAD-59	SEAD-59	SEAD-59	SEAD-59							
Location ID	WS-59-01-016-13	WS-59-01-016-14	WS-59-01-016-18	WS-59-01-016-19	WS-59-01-016-2	WS-59-01-016-20							
Matrix	SOIL	SOIL	SOIL	SOIL	SOIL	SOIL							
Sample ID	WS-59-01-016-13	WS-59-01-016-14	WS-59-01-016-18	WS-59-01-016-19	WS-59-01-016-2	WS-59-01-016-20							
Sample Depth to Top of Sample	0	0	0	0	0	0							
Sample Depth to Bottom of Sample	0	0	0	0	0	0							
Sample Date	5/6/2004	5/6/2004	5/6/2004	5/6/2004	5/6/2004	5/6/2004							
QC Code	SA	SA	SA	SA	SA	SA							
Study ID	ENSR IRM	ENSR IRM	ENSR IRM	ENSR IRM	ENSR IRM	ENSR IRM							
Parameter	Units	Maximum Value	Frequency of Detection	NYSDEC TAGM Level	Number of Exceedances	Number of Times Detected	Number of Sample Analyses	Value (Q)	Value (Q)	Value (Q)	Value (Q)	Value (Q)	Value (Q)
Volatile Organic Compounds													
1,1,1-Trichloroethane	UG/KG	0	0%	800	0	0	53	5.8 U	5.8 U	5.9 U	5.8 U	6 U	5.8 U
1,1,2,2-Tetrachloroethane	UG/KG	0	0%	600	0	0	52	5.8 U	5.8 U	5.9 U	5.8 U	6 U	5.8 U
1,1,2-Trichloro-1,2,2-Trifluoroethane	UG/KG	1.5	2%		0	1	53	1.5 J	5.8 U	5.9 U	5.8 U	6 U	5.8 U
1,1,2-Trichloroethane	UG/KG	0	0%		0	0	5						
1,1-Dichloroethane	UG/KG	0	0%	200	0	0	53	5.8 U	5.8 U	5.9 U	5.8 U	6 U	5.8 U
1,1-Dichloroethene	UG/KG	1	2%	400	0	1	53	5.8 U	5.8 U	5.9 U	5.8 U	6 U	5.8 U
1,2,3-Trichloropropane	UG/KG	0	0%		0	0	47	5.8 U	5.8 U	5.9 U	5.8 U	6 U	5.8 U
1,2,4-Trichlorobenzene	UG/KG	0	0%	3400	0	0	52	5.8 U	5.8 U	5.9 U	5.8 U	6 U	5.8 U
1,2-Dibromo-3-chloropropane	UG/KG	0	0%		0	0	5						
1,2-Dibromoethane	UG/KG	0	0%		0	0	5						
1,2-Dichlorobenzene	UG/KG	0	0%	7900	0	0	52	5.8 U	5.8 U	5.9 U	5.8 U	6 U	5.8 U
1,2-Dichloroethane	UG/KG	0	0%	100	0	0	53	5.8 U	5.8 U	5.9 U	5.8 U	6 U	5.8 U
1,2-Dichloropropane	UG/KG	0	0%		0	0	5						
1,3-Dichlorobenzene	UG/KG	0	0%	1600	0	0	52	5.8 U	5.8 U	5.9 U	5.8 U	6 U	5.8 U
1,3-Dichloropropane	UG/KG	0	0%		0	0	48	5.8 U	5.8 U	5.9 U	5.8 U	6 U	5.8 U
1,4-Dichlorobenzene	UG/KG	0	0%	8500	0	0	52	5.8 U	5.8 U	5.9 U	5.8 U	6 U	5.8 U
Acetone	UG/KG	69	25%	200	0	13	53	23 U	23 U	24 U	23 U	24 U	23 U
Benzene	UG/KG	0	0%	60	0	0	53	5.8 U	5.8 U	5.9 U	5.8 U	6 U	5.8 U
Bromodichloromethane	UG/KG	0	0%		0	0	5						
Bromoform	UG/KG	0	0%		0	0	5						
Carbon disulfide	UG/KG	0	0%	2700	0	0	53	5.8 U	5.8 U	5.9 U	5.8 U	6 U	5.8 U
Carbon tetrachloride	UG/KG	0	0%	600	0	0	53	5.8 U	5.8 U	5.9 U	5.8 U	6 U	5.8 U
Chlorobenzene	UG/KG	0	0%	1700	0	0	53	5.8 U	5.8 U	5.9 U	5.8 U	6 U	5.8 U
Chlorodibromomethane	UG/KG	0	0%		0	0	53	5.8 U	5.8 U	5.9 U	5.8 U	6 U	5.8 U
Chloroethane	UG/KG	0	0%	1900	0	0	53	12 U	12 U	12 U	12 U	12 U	12 U
Chloroform	UG/KG	0	0%	300	0	0	53	5.8 U	5.8 U	5.9 U	5.8 U	6 U	5.8 U
Cis-1,2-Dichloroethene	UG/KG	0	0%		0	0	5						
Cis-1,3-Dichloropropene	UG/KG	0	0%		0	0	5						
Cyclohexane	UG/KG	0	0%		0	0	5						
Dichlorodifluoromethane	UG/KG	0	0%		0	0	5						
Ethyl benzene	UG/KG	0	0%	5500	0	0	53	5.8 U	5.8 U	5.9 U	5.8 U	6 U	5.8 U
Isopropylbenzene	UG/KG	0	0%		0	0	5						
Meta/Para Xylene	UG/KG	2.3	4%		0	2	48	5.8 U	5.8 U	5.9 U	5.8 U	6 U	5.8 U
Methyl Acetate	UG/KG	0	0%		0	0	5						
Methyl Tertbutyl Ether	UG/KG	0	0%		0	0	5						
Methyl bromide	UG/KG	0	0%		0	0	5						
Methyl butyl ketone	UG/KG	0	0%		0	0	5						
Methyl chloride	UG/KG	0	0%		0	0	5						
Methyl cyclohexane	UG/KG	0	0%		0	0	5						
Methyl ethyl ketone	UG/KG	7	9%	300	0	5	53	12 U	12 U	12 U	12 U	12 U	12 U
Methyl isobutyl ketone	UG/KG	0	0%	1000	0	0	53	12 U	12 U	12 U	12 U	12 U	12 U
Methylene chloride	UG/KG	3.45	2%	100	0	1	53	5.8 U	5.8 U	5.9 U	5.8 U	6 U	5.8 U
Ortho Xylene	UG/KG	1.9	10%		0	5	48	5.8 U	5.8 U	5.9 U	5.8 U	6 U	5.8 U
Styrene	UG/KG	0	0%		0	0	5						
Tetrachloroethene	UG/KG	6.7	6%	1400	0	3	53	5.8 U	5.8 U	5.4 J	5.3 J	6 U	6.7
Toluene	UG/KG	0	0%	1500	0	0	53	5.8 U	5.8 U	5.9 U	5.8 U	6 U	5.8 U
Total Xylenes	UG/KG	3	20%	1200	0	1	5						
Trans-1,2-Dichloroethene	UG/KG	0	0%	300	0	0	53	5.8 U	5.8 U	5.9 U	5.8 U	6 U	5.8 U

**Table A-6
SOIL SAMPLE RESULTS
SEAD-59 STOCKPILE
SEAD-59 and SEAD-71 Phase II RI Report
Seneca Army Depot Activity**

Facility	Location ID	Matrix	Sample ID	Sample Depth to Top of Sample	Sample Depth to Bottom of Sample	Sample Date	QC Code	Study ID	SEAD-59	SEAD-59	SEAD-59	SEAD-59	SEAD-59	SEAD-59
									WS-59-01-016-13	WS-59-01-016-14	WS-59-01-016-18	WS-59-01-016-19	WS-59-01-016-2	WS-59-01-016-20
Parameter	Units	Maximum Value	Frequency of Detection	NYSDEC TAGM Level	Number of Exceedances	Number of Times Detected	Number of Sample Analyses	ENSR IRM	ENSR IRM	ENSR IRM	ENSR IRM	ENSR IRM	ENSR IRM	
								1	1	1	1	1	1	
								Value (Q)	Value (Q)	Value (Q)	Value (Q)	Value (Q)	Value (Q)	
Trans-1,3-Dichloropropene	UG/KG	0	0%		0	0	5							
Trichloroethene	UG/KG	4.2	8%	700	0	4	53	5.8 U	5.8 U	5.9 U	5.8 U	6 U	5.8 U	
Trichlorofluoromethane	UG/KG	0	0%		0	0	5							
Vinyl chloride	UG/KG	0	0%	200	0	0	53	12 U	12 U	12 U	12 U	12 U	12 U	
Semivolatile Organics Compounds														
1,1'-Biphenyl	UG/KG	59	20%		0	1	5							
2,2'-oxybis(1-Chloropropane)	UG/KG	0	0%		0	0	5							
2,4,5-Trichlorophenol	UG/KG	0	0%	100	0	0	53	1100 U	1200 U	1900 U	1900 U	1200 U	1900 U	
2,4,6-Trichlorophenol	UG/KG	0	0%		0	0	53	1100 U	1200 U	1900 U	1900 U	1200 U	1900 U	
2,4-Dichlorophenol	UG/KG	0	0%	400	0	0	53	1100 U	1200 U	1900 U	1900 U	1200 U	1900 U	
2,4-Dimethylphenol	UG/KG	0	0%		0	0	5							
2,4-Dinitrophenol	UG/KG	0	0%	200	0	0	53	5900 UJ	5900 UJ	10000 U	9800 U	6100 U	9800 U	
2,4-Dinitrotoluene	UG/KG	0	0%		0	0	53	1100 U	1200 U	1900 U	1900 U	1200 U	1900 U	
2,6-Dinitrotoluene	UG/KG	0	0%	1000	0	0	53	1100 U	1200 U	1900 U	1900 U	1200 U	1900 U	
2-Chloronaphthalene	UG/KG	0	0%		0	0	5							
2-Chlorophenol	UG/KG	0	0%	800	0	0	53	1100 U	1200 U	1900 U	1900 U	1200 U	1900 U	
2-Methylnaphthalene	UG/KG	1200	51%	36400	0	27	53	270 J	270 J	1900 U	1900 U	150 J	1900 U	
2-Methylphenol	UG/KG	0	0%	100	0	0	53	1100 U	1200 U	1900 U	1900 U	1200 U	1900 U	
2-Nitroaniline	UG/KG	0	0%	430	0	0	53	5900 U	5900 U	10000 U	9800 U	6100 U	9800 U	
2-Nitrophenol	UG/KG	0	0%	330	0	0	53	1100 U	1200 U	1900 U	1900 U	1200 U	1900 U	
3,3'-Dichlorobenzidine	UG/KG	0	0%		0	0	53	1100 U	1200 U	1900 U	1900 U	1200 U	1900 U	
3-Nitroaniline	UG/KG	0	0%	500	0	0	53	5900 U	5900 U	10000 U	9800 U	6100 U	9800 U	
4,6-Dinitro-2-methylphenol	UG/KG	0	0%		0	0	5							
4-Bromophenyl phenyl ether	UG/KG	0	0%		0	0	5							
4-Chloro-3-methylphenol	UG/KG	0	0%	240	0	0	53	1100 U	1200 U	1900 U	1900 U	1200 U	1900 U	
4-Chloroaniline	UG/KG	0	0%	220	0	0	53	1100 U	1200 U	1900 U	1900 U	1200 U	1900 U	
4-Chlorophenyl phenyl ether	UG/KG	0	0%		0	0	5							
4-Methylphenol	UG/KG	0	0%	900	0	0	53	1100 U	1200 U	1900 U	1900 U	1200 U	1900 U	
4-Nitroaniline	UG/KG	0	0%		0	0	5							
4-Nitrophenol	UG/KG	0	0%	100	0	0	53	5900 U	5900 U	10000 U	9800 U	6100 U	9800 U	
Acenaphthene	UG/KG	2400	87%	50000	0	46	53	490 J	580 J	1900 U	210 J	360 J	270 J	
Acenaphthylene	UG/KG	3500	98%	41000	0	52	53	1200	1800	200 J	310 J	1600	3400	
Acetophenone	UG/KG	0	0%		0	0	5							
Aniline	UG/KG	0	0%		0	0	48	1100 U	1200 U	1900 U	1900 U	1200 U	1900 U	
Anthracene	UG/KG	6600	100%	50000	0	53	53	1600	3900	280 J	540 J	1500	2200	
Atrazine	UG/KG	0	0%		0	0	5							
Benzaldehyde	UG/KG	0	0%		0	0	5							
Benzo(a)anthracene	UG/KG	14000	100%	224	52	53	53	3600	8400	860 J	1100 J	3800	6800	
Benzo(a)pyrene	UG/KG	16000	100%	61	53	53	53	3700	7300	950 J	1200 J	4600	8500	
Benzo(b)fluoranthene	UG/KG	11000	100%	1100	46	53	53	2800	5300	750 J	1000 J	3400	6400	
Benzo(ghi)perylene	UG/KG	8000	100%	50000	0	53	53	2200	3700	670 J	770 J	2100	5200	
Benzo(k)fluoranthene	UG/KG	13000	100%	1100	46	53	53	3100	5800	790 J	910 J	3800	6500	
Benzoic Acid	UG/KG	0	0%	2700	0	0	48	5900 U	5900 U	10000 U	9800 U	6100 U	9800 U	
Bis(2-Chloroethoxy)methane	UG/KG	0	0%		0	0	5							
Bis(2-Chloroethyl)ether	UG/KG	0	0%		0	0	5							
Bis(2-Ethylhexyl)phthalate	UG/KG	130	6%	50000	0	3	53	1100 U	1200 U	1900 U	1900 U	1200 U	1900 U	
Butylbenzylphthalate	UG/KG	0	0%	50000	0	0	53	1100 U	1200 U	1900 U	1900 U	1200 UJ	1900 U	
Caprolactam	UG/KG	0	0%		0	0	5							
Carbazole	UG/KG	1100	80%		0	4	5							

Table A-6
SOIL SAMPLE RESULTS
SEAD-59 STOCKPILE
SEAD-59 and SEAD-71 Phase II RI Report
Seneca Army Depot Activity

Facility	Location ID	Matrix	Sample ID	Sample Depth to Top of Sample	Sample Depth to Bottom of Sample	Sample Date	QC Code	Study ID	SEAD-59 WS-59-01-016-13	SEAD-59 WS-59-01-016-14	SEAD-59 WS-59-01-016-18	SEAD-59 WS-59-01-016-19	SEAD-59 WS-59-01-016-2	SEAD-59 WS-59-01-016-20	
Parameter	Units	Maximum Value	Frequency of Detection	NYSDEC TAGM Level	Number of Exceedances	Number of Times Detected	Number of Sample Analyses		Value (Q)	Value (Q)	Value (Q)	Value (Q)	Value (Q)	Value (Q)	
Chrysene	UG/KG	13000	100%	400	52	53	53		3500	7900	940J	1200J	3900	7500	
Di-n-butylphthalate	UG/KG	0	0%	8100	0	0	53		1100 U	1200 U	1900 U	1900 U	1200 U	1900 U	
Di-n-octylphthalate	UG/KG	0	0%	50000	0	0	53		1100 U	1200 U	1900 U	1900 U	1200 U	1900 U	
Dibenz(a,h)anthracene	UG/KG	2900	98%	14	52	53	53		660J	1300J	210J	250J	760J	1800J	
Dibenzofuran	UG/KG	1300	62%	6200	0	33	53		320 J	480 J	1900 U	1900 U	210 J	1900 U	
Diethyl phthalate	UG/KG	0	0%	7100	0	0	53		1100 U	1200 U	1900 U	1900 U	1200 U	1900 U	
Dimethylphthalate	UG/KG	0	0%	2000	0	0	53		1100 U	1200 U	1900 U	1900 U	1200 U	1900 U	
Fluoranthene	UG/KG	29000	100%	50000	0	53	53		7300	18000	1800 J	2300	7300	12000	
Fluorene	UG/KG	3100	89%	50000	0	47	53		700 J	1300	1900 U	260 J	520 J	310 J	
Hexachlorobenzene	UG/KG	0	0%	410	0	0	53		1100 U	1200 U	1900 U	1900 U	1200 U	1900 U	
Hexachlorobutadiene	UG/KG	0	0%	0	0	0	53		1100 U	1200 U	1900 U	1900 U	1200 U	1900 U	
Hexachlorocyclopentadiene	UG/KG	0	0%	0	0	0	5								
Hexachloroethane	UG/KG	0	0%	0	0	0	53		1100 U	1200 U	1900 U	1900 U	1200 U	1900 U	
Indeno(1,2,3-cd)pyrene	UG/KG	8000	100%	3200	19	53	53		2100 J	3700J	560 J	740 J	2100 J	5000J	
Isophorone	UG/KG	0	0%	4400	0	0	53		1100 U	1200 U	1900 U	1900 U	1200 U	1900 U	
N-Nitrosodiphenylamine	UG/KG	0	0%	0	0	0	5								
N-Nitrosodipropylamine	UG/KG	0	0%	0	0	0	5								
Naphthalene	UG/KG	1200	62%	13000	0	33	53		340 J	240 J	1900 U	1900 U	140 J	1900 U	
Nitrobenzene	UG/KG	0	0%	200	0	0	53		1100 U	1200 U	1900 U	1900 U	1200 U	1900 U	
Pentachlorophenol	UG/KG	660	2%	1000	0	1	53		5900 U	5900 U	10000 U	9800 U	6100 U	9800 U	
Phenanthrene	UG/KG	17000	100%	50000	0	53	53		4300	11000	840 J	1600 J	3100	3300	
Phenol	UG/KG	0	0%	30	0	0	53		1100 U	1200 U	1900 U	1900 U	1200 U	1900 U	
Pyrene	UG/KG	22000	100%	50000	0	53	53		6000	14000	1300 J	1700 J	6300 J	9700	
Pyridine	UG/KG	0	0%	0	0	0	48		5900 U	5900 U	10000 U	9800 U	6100 U	9800 U	
Pesticides/PCBs															
4,4'-DDD	UG/KG	450	62%	2900	0	33	53		96 U	96 U	97 U	95 U	98 U	95 U	
4,4'-DDE	UG/KG	230	62%	2100	0	33	53		96 U	96 U	97 U	95 U	98 U	95 U	
4,4'-DDT	UG/KG	520	70%	2100	0	37	53		96 U	96 U	97 U	95 U	98 U	95 U	
Aldrin	UG/KG	0	0%	41	0	0	53		49 U	50 U	50 U	49 U	51 U	49 U	
Alpha-BHC	UG/KG	4.4	2%	110	0	1	53		49 U	50 U	50 U	49 U	51 U	49 U	
Alpha-Chlordane	UG/KG	27	11%	0	0	6	53		49 U	50 U	50 U	49 U	51 U	49 U	
Beta-BHC	UG/KG	13	2%	200	0	1	53		49 U	50 U	50 U	49 U	51 U	49 U	
Delta-BHC	UG/KG	0	0%	300	0	0	53		49 U	50 U	50 U	49 U	51 U	49 U	
Dieldrin	UG/KG	0	0%	44	0	0	53		96 U	96 U	97 U	95 U	98 U	95 U	
Endosulfan I	UG/KG	0	0%	900	0	0	53		49 U	50 U	50 U	49 U	51 U	49 U	
Endosulfan II	UG/KG	0	0%	900	0	0	53		96 U	96 U	97 U	95 U	98 U	95 U	
Endosulfan sulfate	UG/KG	0	0%	1000	0	0	53		96 U	96 U	97 U	95 U	98 U	95 U	
Endrin	UG/KG	0	0%	100	0	0	53		96 U	96 U	97 U	95 U	98 U	95 U	
Endrin aldehyde	UG/KG	0	0%	0	0	0	53		96 U	96 U	97 U	95 U	98 U	95 U	
Endrin ketone	UG/KG	15	2%	0	0	1	53		96 U	96 U	97 U	95 U	98 U	95 U	

**Table A-6
SOIL SAMPLE RESULTS
SEAD-59 STOCKPILE
SEAD-59 and SEAD-71 Phase II RI Report
Seneca Army Depot Activity**

Facility	Location ID	Matrix	Sample ID	Sample Depth to Top of Sample	Sample Depth to Bottom of Sample	Sample Date	QC Code	Study ID	SEAD-59	SEAD-59	SEAD-59	SEAD-59	SEAD-59	SEAD-59
									WS-59-01-016-13	WS-59-01-016-14	WS-59-01-016-18	WS-59-01-016-19	WS-59-01-016-2	WS-59-01-016-20
Parameter	Units	Maximum Value	Frequency of Detection	NYSDEC TAGM Level	Number of Exceedances	Number of Times Detected	Number of Sample Analyses	ENSR IRM	ENSR IRM	ENSR IRM	ENSR IRM	ENSR IRM	ENSR IRM	
								1	1	1	1	1	1	
								Value (Q)	Value (Q)	Value (Q)	Value (Q)	Value (Q)	Value (Q)	
Gamma-BHC/Lindane	UG/KG	0	0%	60	0	0	53	49 U	50 U	50 U	49 U	51 U	49 U	
Gamma-Chlordane	UG/KG	21	9%	540	0	5	53	49 U	50 U	50 U	49 U	51 U	49 U	
Heptachlor	UG/KG	0	0%	100	0	0	53	49 U	50 U	50 U	49 U	51 U	49 U	
Heptachlor epoxide	UG/KG	0	0%	20	0	0	53	49 U	50 U	50 U	49 U	51 U	49 U	
Methoxychlor	UG/KG	0	0%		0	0	53	490 U	500 U	500 U	490 U	510 U	490 U	
Toxaphene	UG/KG	0	0%		0	0	53	960 U	970 U	970 U	950 U	980 U	950 U	
Aroclor-1016	UG/KG	0	0%		0	0	53	38 U	38 U	39 U	38 U	39 U	38 U	
Aroclor-1221	UG/KG	0	0%		0	0	53	38 U	38 U	39 U	38 U	39 U	38 U	
Aroclor-1232	UG/KG	0	0%		0	0	53	38 U	38 U	39 U	38 U	39 U	38 U	
Aroclor-1242	UG/KG	0	0%		0	0	53	38 U	38 U	39 U	38 U	39 U	38 U	
Aroclor-1248	UG/KG	0	0%		0	0	53	38 U	38 U	39 U	38 U	39 U	38 U	
Aroclor-1254	UG/KG	0	0%	10000	0	0	53	38 U	38 U	39 U	38 U	39 U	38 U	
Aroclor-1260	UG/KG	0	0%	10000	0	0	53	38 U	38 U	39 U	38 U	39 U	38 U	
Metals														
Aluminum	MG/KG	13400	100%	19300	0	53	53	11200	11200	10800	10800	11600	9200	
Antimony	MG/KG	43.9	21%	5.9	3	11	53	3.4 UJ	3.5 UJ	3.5 UJ	3.4 UJ	3.5 UJ	3.4 UJ	
Arsenic	MG/KG	7.3	100%	8.2	0	53	53	4.1	4.6	4.6	4.3	5.2	3.9	
Barium	MG/KG	135	100%	300	0	53	53	90.3	78.9	85	92.4	90.3	74	
Beryllium	MG/KG	0.69	100%	1.1	0	53	53	0.4	0.3	0.3	0.38	0.41	0.25	
Cadmium	MG/KG	1.2	98%	2.3	0	52	53	0.72	0.78	0.97	0.73	0.7	0.66	
Calcium	MG/KG	100000	100%	121000	0	53	53	58200	46000	42800	41200	45700	100000	
Chromium	MG/KG	35	100%	29.6	3	53	53	19.3	29.7	35	19.3	19.4	16.4	
Cobalt	MG/KG	13.9	100%	30	0	53	53	9.9	9.6	9.2	9.3	12.3	7.6	
Copper	MG/KG	51.8	100%	33	14	53	53	44.1 J	25.6 J	51.8 J	36.4 J	28.8 J	28.7 J	
Iron	MG/KG	26500	100%	36500	0	53	53	19300	22400	20200	19800	23000	16300	
Lead	MG/KG	1440	100%	24.8	51	53	53	51.5 J	84.6 J	129 J	41.7 J	45.8 J	44.8 J	
Magnesium	MG/KG	26600	100%	21500	1	53	53	8530	7860	9170	8050	7260	7730	
Manganese	MG/KG	1220	100%	1060	2	53	53	455	435	459	457	556	391	
Mercury	MG/KG	0.52	100%	0.1	9	53	53	0.15	0.04	0.51	0.29	0.1	0.28	
Nickel	MG/KG	56.6	100%	49	1	53	53	30.9	26.4	27.3	28	30.7	22.4	
Potassium	MG/KG	1580	100%	2380	0	53	53	1170	1200	1240	1170	1230	1090	
Selenium	MG/KG	0.72	4%	2	0	2	53	0.57 U	0.58 U	0.58 U	0.57 U	0.59 U	0.56 U	
Silver	MG/KG	4.7	17%	0.75	6	9	53	0.57 U	0.58 U	4.7	1.2 J	0.59 U	0.56 U	
Sodium	MG/KG	525	100%	172	23	53	53	236	239	398	455	129	178	
Thallium	MG/KG	0.99	51%	0.7	12	27	53	0.65 J	0.58 U	0.58 U	0.57 U	0.59 U	0.56 U	
Vanadium	MG/KG	35.4	100%	150	0	53	53	19.3	20.1	20.8	20.5	20	19	
Zinc	MG/KG	185	100%	110	6	53	53	92.8 J	72.7 J	157 J	93 J	82.2 J	79 J	

Note(s):
 (1) - NYSDEC Technical and Administrative Guidance Memorandum (TAGM) HWR-94-4046, Revised January 24, 1994
 (2) - Sample-Duplicate pairs are presented as a combined sample in this table.
 Their Sample ID is a combination of the sample and the sample duplicate Sample ID (for example FD-59-CL-05/CL-59-01-WS1)
 In addition, the 'QC Code' field is labeled 'SADU'

U = compound was not detected
 J = the reported value is an estimated concentration
 UJ = the compound was not detected; the associated reporting limit is approximate
 R = the data was rejected in the data validating process
 NJ = compound was "tentatively identified" and the associated numerical value is approximate

Table A-6
SOIL SAMPLE RESULTS
SEAD-59 STOCKPILE
SEAD-59 and SEAD-71 Phase II RI Report
Seneca Army Depot Activity

Facility	SEAD-59	SEAD-59	SEAD-59	SEAD-59	SEAD-59	SEAD-59							
Location ID	WS-59-01-016-3	WS-59-01-016-4	WS-59-01-016-5	WS-59-01-016-6	WS-59-01-016-9	WS-59-04-010-8							
Matrix	SOIL	SOIL	SOIL	SOIL	SOIL	SOIL							
Sample ID	WS-59-01-016-3	WS-59-01-016-4	WS-59-01-016-5	WS-59-01-016-6	WS-59-01-016-9	WS-59-04-010-8							
Sample Depth to Top of Sample	0	0	0	0	0	0							
Sample Depth to Bottom of Sample	0	0	0	0	0	0							
Sample Date	5/6/2004	5/6/2004	5/6/2004	5/6/2004	5/6/2004	5/6/2004							
QC Code	SA	SA	SA	SA	SA	SA							
Study ID	ENSR IRM	ENSR IRM	ENSR IRM	ENSR IRM	ENSR IRM	ENSR IRM							
Parameter	Units	Maximum Value	Frequency of Detection	NYSDEC TAGM Level	Number of Exceedances	Number of Times Detected	Number of Sample Analyses	Value (Q)	Value (Q)	Value (Q)	Value (Q)	Value (Q)	Value (Q)
Volatile Organic Compounds													
1,1,1-Trichloroethane	UG/KG	0	0%	800	0	0	53	5.8 U	5.8 U	5.9 U	5.7 U	5.7 U	5 U
1,1,2,2-Tetrachloroethane	UG/KG	0	0%	600	0	0	52	5.8 U	5.8 U	5.9 U	5.7 U	5.7 U	5 U
1,1,2-Trichloro-1,2,2-Trifluoroethane	UG/KG	1.5	2%		0	1	53	5.8 U	5.8 U	5.9 U	5.7 U	5.7 U	5 UJ
1,1,2-Trichloroethane	UG/KG	0	0%		0	0	5						5 U
1,1-Dichloroethane	UG/KG	0	0%	200	0	0	53	5.8 U	5.8 U	5.9 U	5.7 U	5.7 U	5 U
1,1-Dichloroethene	UG/KG	1	2%	400	0	1	53	5.8 U	5.8 U	5.9 U	5.7 U	5.7 U	5 U
1,2,3-Trichloropropane	UG/KG	0	0%		0	0	47	5.8 U	5.8 U	5.9 U	5.7 U	5.7 U	5 U
1,2,4-Trichlorobenzene	UG/KG	0	0%	3400	0	0	52	5.8 U	5.8 U	5.9 U	5.7 U	5.7 U	5 U
1,2-Dibromo-3-chloropropane	UG/KG	0	0%		0	0	5						5 U
1,2-Dibromoethane	UG/KG	0	0%		0	0	5						5 U
1,2-Dichlorobenzene	UG/KG	0	0%	7900	0	0	52	5.8 U	5.8 U	5.9 U	5.7 U	5.7 U	5 U
1,2-Dichloroethane	UG/KG	0	0%	100	0	0	53	5.8 U	5.8 U	5.9 U	5.7 U	5.7 U	5 U
1,2-Dichloropropane	UG/KG	0	0%		0	0	5						5 U
1,3-Dichlorobenzene	UG/KG	0	0%	1600	0	0	52	5.8 U	5.8 U	5.9 U	5.7 U	5.7 U	5 U
1,3-Dichloropropane	UG/KG	0	0%		0	0	48	5.8 U	5.8 U	5.9 U	5.7 U	5.7 U	5 U
1,4-Dichlorobenzene	UG/KG	0	0%	8500	0	0	52	5.8 U	5.8 U	5.9 U	5.7 U	5.7 U	5 U
Acetone	UG/KG	69	25%	200	0	13	53	23 U	23 U	34	23 U	14 J	5 U
Benzene	UG/KG	0	0%	60	0	0	53	5.8 U	5.8 U	5.9 U	5.7 U	5.7 U	5 U
Bromodichloromethane	UG/KG	0	0%		0	0	5						5 U
Bromoform	UG/KG	0	0%		0	0	5						5 U
Carbon disulfide	UG/KG	0	0%	2700	0	0	53	5.8 U	5.8 U	5.9 U	5.7 U	5.7 U	5 U
Carbon tetrachloride	UG/KG	0	0%	600	0	0	53	5.8 U	5.8 U	5.9 U	5.7 U	5.7 U	5 U
Chlorobenzene	UG/KG	0	0%	1700	0	0	53	5.8 U	5.8 U	5.9 U	5.7 U	5.7 U	5 U
Chlorodibromomethane	UG/KG	0	0%		0	0	53	5.8 U	5.8 U	5.9 U	5.7 U	5.7 U	5 U
Chloroethane	UG/KG	0	0%	1900	0	0	53	12 U	12 U	12 U	11 U	11 U	5 U
Chloroform	UG/KG	0	0%	300	0	0	53	5.8 U	5.8 U	5.9 U	5.7 U	5.7 U	5 U
Cis-1,2-Dichloroethene	UG/KG	0	0%		0	0	5						5 U
Cis-1,3-Dichloropropene	UG/KG	0	0%		0	0	5						5 U
Cyclohexane	UG/KG	0	0%		0	0	5						5 U
Dichlorodifluoromethane	UG/KG	0	0%		0	0	5						5 U
Ethyl benzene	UG/KG	0	0%	5500	0	0	53	5.8 U	5.8 U	5.9 U	5.7 U	5.7 U	5 U
Isopropylbenzene	UG/KG	0	0%		0	0	5						5 U
Meta/Para Xylene	UG/KG	2.3	4%		0	2	48	5.8 U	5.8 U	5.9 U	5.7 U	5.7 U	5 U
Methyl Acetate	UG/KG	0	0%		0	0	5						5 U
Methyl Tertbutyl Ether	UG/KG	0	0%		0	0	5						5 U
Methyl bromide	UG/KG	0	0%		0	0	5						5 U
Methyl butyl ketone	UG/KG	0	0%		0	0	5						5 U
Methyl chloride	UG/KG	0	0%		0	0	5						5 U
Methyl cyclohexane	UG/KG	0	0%		0	0	5						5 U
Methyl ethyl ketone	UG/KG	7	9%	300	0	5	53	12 U	12 U	2.9 J	11 U	11 U	5 U
Methyl isobutyl ketone	UG/KG	0	0%	1000	0	0	53	12 U	12 U	12 U	11 U	11 U	5 U
Methylene chloride	UG/KG	3.45	2%	100	0	1	53	5.8 U	5.8 U	5.9 U	5.7 U	5.7 U	5 U
Ortho Xylene	UG/KG	1.9	10%		0	5	48	5.8 U	5.8 U	5.9 U	5.7 U	5.7 U	5 U
Styrene	UG/KG	0	0%		0	0	5						5 U
Tetrachloroethene	UG/KG	6.7	6%	1400	0	3	53	5.8 U	5.8 U	5.9 U	5.7 U	5.7 U	5 U
Toluene	UG/KG	0	0%	1500	0	0	53	5.8 U	5.8 U	5.9 U	5.7 U	5.7 U	5 U
Total Xylenes	UG/KG	3	20%	1200	0	1	5						5 U
Trans-1,2-Dichloroethene	UG/KG	0	0%	300	0	0	53	5.8 U	5.8 U	5.9 U	5.7 U	5.7 U	5 U

**Table A-6
SOIL SAMPLE RESULTS
SEAD-59 STOCKPILE
SEAD-59 and SEAD-71 Phase II RI Report
Seneca Army Depot Activity**

Facility	SEAD-59	SEAD-59	SEAD-59	SEAD-59	SEAD-59	SEAD-59							
Location ID	WS-59-01-016-3	WS-59-01-016-4	WS-59-01-016-5	WS-59-01-016-6	WS-59-01-016-9	WS-59-04-010-8							
Matrix	SOIL	SOIL	SOIL	SOIL	SOIL	SOIL							
Sample ID	WS-59-01-016-3	WS-59-01-016-4	WS-59-01-016-5	WS-59-01-016-6	WS-59-01-016-9	WS-59-04-010-8							
Sample Depth to Top of Sample	0	0	0	0	0	0							
Sample Depth to Bottom of Sample	0	0	0	0	0	0							
Sample Date	5/6/2004	5/6/2004	5/6/2004	5/6/2004	5/6/2004	5/6/2004							
QC Code	SA	SA	SA	SA	SA	SA							
Study ID	ENSR IRM	ENSR IRM	ENSR IRM	ENSR IRM	ENSR IRM	ENSR IRM							
	1	1	1	1	1	1							
Parameter	Units	Maximum Value	Frequency of Detection	NYSDEC TAGM Level	Number of Exceedances	Number of Times Detected	Number of Sample Analyses	Value (Q)	Value (Q)	Value (Q)	Value (Q)	Value (Q)	Value (Q)
Trans-1,3-Dichloropropene	UG/KG	0	0%		0	0	5						5 U
Trichloroethene	UG/KG	4.2	8%	700	0	4	53	5.8 U	5.8 U	5.9 U	5.7 U	5.7 U	5 U
Trichlorofluoromethane	UG/KG	0	0%		0	0	5						5 U
Vinyl chloride	UG/KG	0	0%	200	0	0	53	12 U	12 U	12 U	11 U	11 U	5 U
Semivolatile Organics Compounds													
1,1'-Biphenyl	UG/KG	59	20%		0	1	5						370 U
2,2'-oxybis(1-Chloropropane)	UG/KG	0	0%		0	0	5						370 U
2,4,5-Trichlorophenol	UG/KG	0	0%	100	0	0	53	1200 U	1100 U	2000 U	1900 U	1900 U	930 U
2,4,6-Trichlorophenol	UG/KG	0	0%		0	0	53	1200 U	1100 U	2000 U	1900 U	1900 U	370 U
2,4-Dichlorophenol	UG/KG	0	0%	400	0	0	53	1200 U	1100 U	2000 U	1900 U	1900 U	370 U
2,4-Dimethylphenol	UG/KG	0	0%		0	0	5						370 U
2,4-Dinitrophenol	UG/KG	0	0%	200	0	0	53	5900 U	5900 U	10000 U	9700 UJ	9700 UJ	930 U
2,4-Dinitrotoluene	UG/KG	0	0%		0	0	53	1200 U	1100 U	2000 U	1900 U	1900 U	370 U
2,6-Dinitrotoluene	UG/KG	0	0%	1000	0	0	53	1200 U	1100 U	2000 U	1900 U	1900 U	370 U
2-Chloronaphthalene	UG/KG	0	0%		0	0	5						370 U
2-Chlorophenol	UG/KG	0	0%	800	0	0	53	1200 U	1100 U	2000 U	1900 U	1900 U	370 U
2-Methylnaphthalene	UG/KG	1200	51%	36400	0	27	53	1200 U	1100 U	310 J	240 J	210 J	370 U
2-Methylphenol	UG/KG	0	0%	100	0	0	53	1200 U	1100 U	2000 U	1900 U	1900 U	370 U
2-Nitroaniline	UG/KG	0	0%	430	0	0	53	5900 U	5900 U	10000 U	9700 U	9700 U	930 U
2-Nitrophenol	UG/KG	0	0%	330	0	0	53	1200 U	1100 U	2000 U	1900 U	1900 U	370 U
3,3'-Dichlorobenzidine	UG/KG	0	0%		0	0	53	1200 U	1100 U	2000 U	1900 U	1900 U	370 U
3-Nitroaniline	UG/KG	0	0%	500	0	0	53	5900 U	5900 U	10000 U	9700 U	9700 U	930 U
4,6-Dinitro-2-methylphenol	UG/KG	0	0%		0	0	5						930 U
4-Bromophenyl phenyl ether	UG/KG	0	0%		0	0	5						370 U
4-Chloro-3-methylphenol	UG/KG	0	0%	240	0	0	53	1200 U	1100 U	2000 U	1900 U	1900 U	370 U
4-Chloroaniline	UG/KG	0	0%	220	0	0	53	1200 U	1100 U	2000 U	1900 U	1900 U	370 U
4-Chlorophenyl phenyl ether	UG/KG	0	0%		0	0	5						370 U
4-Methylphenol	UG/KG	0	0%	900	0	0	53	1200 U	1100 U	2000 U	1900 U	1900 U	370 U
4-Nitroaniline	UG/KG	0	0%		0	0	5						930 U
4-Nitrophenol	UG/KG	0	0%	100	0	0	53	5900 U	5900 U	10000 U	9700 U	9700 U	930 U
Acenaphthene	UG/KG	2400	87%	50000	0	46	53	210 J	1100 U	620 J	550 J	2400	370 U
Acenaphthylene	UG/KG	3500	98%	41000	0	52	53	800 J	380 J	1500 J	1600 J	2200	370 U
Acetophenone	UG/KG	0	0%		0	0	5						370 U
Aniline	UG/KG	0	0%		0	0	48	1200 U	1100 U	2000 U	1900 U	1900 U	370 U
Anthracene	UG/KG	6600	100%	50000	0	53	53	830 J	280 J	2300	2400	4600	120 J
Atrazine	UG/KG	0	0%		0	0	5						370 U
Benzaldehyde	UG/KG	0	0%		0	0	5						370 U
Benzo(a)anthracene	UG/KG	14000	100%	224	52	53	53	2700	900 J	4400	5000	7700	86 NJ
Benzo(a)pyrene	UG/KG	16000	100%	61	53	53	53	2900	1000 J	4400	4700	6700	85 J
Benzo(b)fluoranthene	UG/KG	11000	100%	1100	46	53	53	2300	850 J	3300	3100	4900	110 J
Benzo(ghi)perylene	UG/KG	8000	100%	50000	0	53	53	1400	530 J	2000	3000	4000	52 J
Benzo(k)fluoranthene	UG/KG	13000	100%	1100	46	53	53	2500	930 J	3700	3700	5500	48 J
Benzoic Acid	UG/KG	0	0%	2700	0	0	48	5900 U	5900 U	10000 U	9700 U	9700 U	
Bis(2-Chloroethoxy)methane	UG/KG	0	0%		0	0	5						370 U
Bis(2-Chloroethyl)ether	UG/KG	0	0%		0	0	5						370 U
Bis(2-Ethylhexyl)phthalate	UG/KG	130	6%	50000	0	3	53	1200 U	1100 U	2000 U	1900 U	1900 U	97 J
Butylbenzylphthalate	UG/KG	0	0%	50000	0	0	53	1200 UJ	1100 UJ	2000 UJ	1900 U	1900 U	370 U
Caprolactam	UG/KG	0	0%		0	0	5						370 U
Carbazole	UG/KG	1100	80%		0	4	5						370 U

Table A-6
SOIL SAMPLE RESULTS
SEAD-59 STOCKPILE
SEAD-59 and SEAD-71 Phase II RI Report
Seneca Army Depot Activity

Facility	Location ID	Matrix	Sample ID	Sample Depth to Top of Sample	Sample Depth to Bottom of Sample	Sample Date	QC Code	Study ID	SEAD-59 WS-59-01-016-3	SEAD-59 WS-59-01-016-4	SEAD-59 WS-59-01-016-5	SEAD-59 WS-59-01-016-6	SEAD-59 WS-59-01-016-9	SEAD-59 WS-59-04-010-8	
Parameter	Units	Maximum Value	Frequency of Detection	NYSDEC TAGM Level	Number of Exceedances	Number of Times Detected	Number of Sample Analyses		Value (Q)	Value (Q)	Value (Q)	Value (Q)	Value (Q)	Value (Q)	
Chrysene	UG/KG	13000	100%	400	52	53	53		2700	970J	4300	4900	7600	87 J	
Di-n-butylphthalate	UG/KG	0	0%	8100	0	0	53		1200 U	1100 U	2000 U	1900 U	1900 U	370 U	
Di-n-octylphthalate	UG/KG	0	0%	50000	0	0	53		1200 U	1100 U	2000 U	1900 U	1900 U	370 U	
Dibenz(a,h)anthracene	UG/KG	2900	98%	14	52	53	53		510J	180J	700J	960J	1400J	370 U	
Dibenzofuran	UG/KG	1300	62%	6200	0	33	53		1200 U	1100 U	540 J	420 J	1300 J	370 U	
Diethyl phthalate	UG/KG	0	0%	7100	0	0	53		1200 U	1100 U	2000 U	1900 U	1900 U	370 U	
Dimethylphthalate	UG/KG	0	0%	2000	0	0	53		1200 U	1100 U	2000 U	1900 U	1900 U	370 U	
Fluoranthene	UG/KG	29000	100%	50000	0	53	53		5400	1700	9900	10000	18000	170 J	
Fluorene	UG/KG	3100	89%	50000	0	47	53		200 J	1100 U	1100 J	1200 J	3100	370 U	
Hexachlorobenzene	UG/KG	0	0%	410	0	0	53		1200 U	1100 U	2000 U	1900 U	1900 U	370 U	
Hexachlorobutadiene	UG/KG	0	0%	0	0	0	53		1200 U	1100 U	2000 U	1900 U	1900 U	370 U	
Hexachlorocyclopentadiene	UG/KG	0	0%	0	0	0	5							370 U	
Hexachloroethane	UG/KG	0	0%	0	0	0	53		1200 U	1100 U	2000 U	1900 U	1900 U	370 U	
Indeno(1,2,3-cd)pyrene	UG/KG	8000	100%	3200	19	53	53		1400 J	530 J	2000 J	2700 J	3800J	55 J	
Isophorone	UG/KG	0	0%	4400	0	0	53		1200 U	1100 U	2000 U	1900 U	1900 U	370 U	
N-Nitrosodiphenylamine	UG/KG	0	0%	0	0	0	5							370 U	
N-Nitrosodipropylamine	UG/KG	0	0%	0	0	0	5							370 U	
Naphthalene	UG/KG	1200	62%	13000	0	33	53		1200 U	1100 U	360 J	280 J	290 J	370 U	
Nitrobenzene	UG/KG	0	0%	200	0	0	53		1200 U	1100 U	2000 U	1900 U	1900 U	370 U	
Pentachlorophenol	UG/KG	660	2%	1000	0	1	53		5900 U	5900 U	10000 U	9700 U	9700 U	930 U	
Phenanthrene	UG/KG	17000	100%	50000	0	53	53		2200	780 J	6900	7400	13000	120 J	
Phenol	UG/KG	0	0%	30	0	0	53		1200 U	1100 U	2000 U	1900 U	1900 U	370 U	
Pyrene	UG/KG	22000	100%	50000	0	53	53		4300 J	1400 J	8300 J	11000	16000	160 J	
Pyridine	UG/KG	0	0%	0	0	0	48		5900 U	5900 U	10000 U	9700 U	9700 U		
Pesticides/PCBs															
4,4'-DDD	UG/KG	450	62%	2900	0	33	53		96 U	96 U	98 U	94 U	94 U	6	
4,4'-DDE	UG/KG	230	62%	2100	0	33	53		96 U	96 U	98 U	94 U	94 U	2.4 J	
4,4'-DDT	UG/KG	520	70%	2100	0	37	53		96 U	96 U	98 U	94 U	94 U	6.1 J	
Aldrin	UG/KG	0	0%	41	0	0	53		49 U	49 U	51 U	48 U	48 U	1.9 U	
Alpha-BHC	UG/KG	4.4	2%	110	0	1	53		49 U	49 U	51 U	48 U	48 U	1.9 U	
Alpha-Chlordane	UG/KG	27	11%	0	0	6	53		49 U	49 U	51 U	48 U	48 U	16 J	
Beta-BHC	UG/KG	13	2%	200	0	1	53		49 U	49 U	51 U	48 U	48 U	1.9 U	
Delta-BHC	UG/KG	0	0%	300	0	0	53		49 U	49 U	51 U	48 U	48 U	1.9 U	
Dieldrin	UG/KG	0	0%	44	0	0	53		96 U	96 U	98 U	94 U	94 U	3.7 U	
Endosulfan I	UG/KG	0	0%	900	0	0	53		49 U	49 U	51 U	48 U	48 U	1.9 U	
Endosulfan II	UG/KG	0	0%	900	0	0	53		96 U	96 U	98 U	94 U	94 U	3.7 U	
Endosulfan sulfate	UG/KG	0	0%	1000	0	0	53		96 U	96 U	98 U	94 U	94 U	3.7 U	
Endrin	UG/KG	0	0%	100	0	0	53		96 U	96 U	98 U	94 U	94 U	3.7 U	
Endrin aldehyde	UG/KG	0	0%	0	0	0	53		96 U	96 U	98 U	94 U	94 U	3.7 U	
Endrin ketone	UG/KG	15	2%	0	0	1	53		96 U	96 U	98 U	94 U	94 U	3.7 U	

Table A-6
SOIL SAMPLE RESULTS
SEAD-59 STOCKPILE
SEAD-59 and SEAD-71 Phase II RI Report
Seneca Army Depot Activity

Facility	Location ID	Matrix	Sample ID	Sample Depth to Top of Sample	Sample Depth to Bottom of Sample	Sample Date	QC Code	Study ID	SEAD-59 WS-59-01-016-3	SEAD-59 WS-59-01-016-4	SEAD-59 WS-59-01-016-5	SEAD-59 WS-59-01-016-6	SEAD-59 WS-59-01-016-9	SEAD-59 WS-59-04-010-8	
Parameter	Units	Maximum Value	Frequency of Detection	NYSDEC TAGM Level	Number of Exceedances	Number of Times Detected	Number of Sample Analyses		ENSR IRM 1	ENSR IRM 1	ENSR IRM 1	ENSR IRM 1	ENSR IRM 1	ENSR IRM 1	
		Value							Value (Q)	Value (Q)	Value (Q)	Value (Q)	Value (Q)	Value (Q)	
Gamma-BHC/Lindane	UG/KG	0	0%	60	0	0	53		49 U	49 U	51 U	48 U	48 U	1.9 U	
Gamma-Chlordane	UG/KG	21	9%	540	0	5	53		49 U	49 U	51 U	48 U	48 U	15	
Heptachlor	UG/KG	0	0%	100	0	0	53		49 U	49 U	51 U	48 U	48 U	1.9 U	
Heptachlor epoxide	UG/KG	0	0%	20	0	0	53		49 U	49 U	51 U	48 U	48 U	1.9 U	
Methoxychlor	UG/KG	0	0%	0	0	0	53		490 U	490 U	510 U	480 U	480 U	19 U	
Toxaphene	UG/KG	0	0%	0	0	0	53		960 U	960 U	980 U	940 U	940 U	190 U	
Aroclor-1016	UG/KG	0	0%	0	0	0	53		38 U	38 U	39 U	38 U	38 U	37 U	
Aroclor-1221	UG/KG	0	0%	0	0	0	53		38 U	38 U	39 U	38 U	38 U	37 U	
Aroclor-1232	UG/KG	0	0%	0	0	0	53		38 U	38 U	39 U	38 U	38 U	37 U	
Aroclor-1242	UG/KG	0	0%	0	0	0	53		38 U	38 U	39 U	38 U	38 U	37 U	
Aroclor-1248	UG/KG	0	0%	0	0	0	53		38 U	38 U	39 U	38 U	38 U	37 U	
Aroclor-1254	UG/KG	0	0%	10000	0	0	53		38 U	38 U	39 U	38 U	38 U	37 U	
Aroclor-1260	UG/KG	0	0%	10000	0	0	53		38 U	38 U	39 U	38 U	38 U	37 U	
Metals															
Aluminum	MG/KG	13400	100%	19300	0	53	53		10600	11000	11500	9410	10900	6830 J	
Antimony	MG/KG	43.9	21%	5.9	3	11	53		3.5 UJ	3.4 UJ	4.6 J	3.4 UJ	3.3 UJ	0.96 J	
Arsenic	MG/KG	7.3	100%	8.2	0	53	53		4.9	5	6.8	4.2	4.4	3.7 J	
Barium	MG/KG	135	100%	300	0	53	53		86.4	86.5	126	94.4	85	62.7 J	
Beryllium	MG/KG	0.69	100%	1.1	0	53	53		0.38	0.39	0.41	0.26	0.37	0.35	
Cadmium	MG/KG	1.2	98%	2.3	0	52	53		0.69	0.68	1.2	1.1	0.77	0.4	
Calcium	MG/KG	100000	100%	121000	0	53	53		66200	43600	56900	72100	60200	72900	
Chromium	MG/KG	35	100%	29.6	3	53	53		17.2	18.5	20.7	16.1	19.3	11.4 J	
Cobalt	MG/KG	13.9	100%	30	0	53	53		9.2	11.2	10.9	8.8	9.4	6.1 J	
Copper	MG/KG	51.8	100%	33	14	53	53		26.5 J	26.5 J	42.5 J	33.6 J	31.1 J	32.5 J	
Iron	MG/KG	26500	100%	36500	0	53	53		20300	22500	26300	18300	20600	14900	
Lead	MG/KG	1440	100%	24.8	51	53	53		31.8 J	29.4 J	75.3 J	59.7 J	61.8 J	15.4 J	
Magnesium	MG/KG	26600	100%	21500	1	53	53		9530	7450	6490	13900	7580	15700 J	
Manganese	MG/KG	1220	100%	1060	2	53	53		466	515	1220	574	512	321 J	
Mercury	MG/KG	0.52	100%	0.1	9	53	53		0.05	0.12	0.07	0.1	0.14	0.52 J	
Nickel	MG/KG	56.6	100%	49	1	53	53		25.6	30.3	26.1	24.1	27	19.1 J	
Potassium	MG/KG	1580	100%	2380	0	53	53		1120	1230	1260	1120	1200	1200 J	
Selenium	MG/KG	0.72	4%	2	0	2	53		0.58 U	0.56 U	0.56 U	0.56 U	0.27 U	0.45 U	
Silver	MG/KG	4.7	17%	0.75	6	9	53		0.58 U	0.56 U	0.56 U	0.56 U	0.55 U	4.1 J	
Sodium	MG/KG	525	100%	172	23	53	53		312	525	123	178	176	140 J	
Thallium	MG/KG	0.99	51%	0.7	12	27	53		0.58 U	0.56 U	0.56 U	0.56 U	0.55 U	0.22 U	
Vanadium	MG/KG	35.4	100%	150	0	53	53		18.6	19.4	23.7	17.6	19.1	13.7 J	
Zinc	MG/KG	185	100%	110	6	53	53		76.5 J	90.5 J	109 J	75.4 J	91.5 J	63.2 J	

Note(s):

(1) - NYSDEC Technical and Administrative Guidance Memorandum (TAGM) HWR-94-4046, Revised January 24, 1994

(2) - Sample-Duplicate pairs are presented as a combined sample in this table.

Their Sample ID is a combination of the sample and the sample duplicate Sample ID (for example FD-59-CL-05/CL-59-01-WS1)

In addition, the 'QC Code' field is labeled 'SADU'

U = compound was not detected

J = the reported value is an estimated concentration

UJ = the compound was not detected; the associated reporting limit is approximate

R = the data was rejected in the data validating process

NJ = compound was "tentatively identified" and the associated numerical value is approximate

Table A-7A
Benzo(a)pyrene Toxicity Equivalency for SEAD-59 Surface Soil (0-2 ft)
SEAD-59 and SEAD-71 Phase II RI Report
Seneca Army Depot Activity

Parameter	Units	SEAD-59 CL-59-01-F01 SOIL CL-59-01-F01 5/6/2004	SEAD-59 CL-59-01-F02 SOIL CL-59-01-F02 5/6/2004	SEAD-59 CL-59-01-F03 SOIL CL-59-01-F03 5/6/2004	SEAD-59 CL-59-01-F04 SOIL CL-59-01-F04 5/6/2004	SEAD-59 CL-59-01-F05 SOIL CL-59-01-F05 5/6/2004	SEAD-59 CL-59-01-F06 SOIL CL-59-01-F06 5/6/2004	SEAD-59 CL-59-01-F07 SOIL CL-59-01-F07 5/6/2004	SEAD-59 CL-59-01-F08 SOIL CL-59-01-F08 5/6/2004
Benzo(a)anthracene	UG/KG	360 U	380 U	410 U	240 J	390 U	370 U	86 NJ	370 U
Benzo(a)pyrene	UG/KG	360 U	380 U	410 U	270 J	390 U	370 U	95 J	370 U
Benzo(b)fluoranthene	UG/KG	360 U	380 U	410 U	200 J	390 U	370 U	120 J	370 U
Benzo(k)fluoranthene	UG/KG	360 U	380 U	410 U	200 J	390 U	370 U	48 J	370 U
Chrysene	UG/KG	360 U	380 U	410 U	260 J	390 U	370 U	90 J	370 U
Dibenz(a,h)anthracene	UG/KG	360 U	380 U	410 U	59 J	390 U	370 U	410 U	370 U
Indeno(1,2,3-cd)pyrene	UG/KG	360 U	380 U	410 U	180 J	390 U	370 U	57 J	370 U
BTE Concentration (ug/kg)		417.6	440.8	475.6	395.6	452.4	429.2	327.68	429.2

Parameter	Units	SEAD-59 FD-59-WS-05 SOIL FD-59-WS-05 5/6/2004	SEAD-59 FD-59-WS-07 SOIL FD-59-WS-07 5/6/2004	SEAD-59 FD-59-WS-8 SOIL FD-59-WS-8 5/6/2004	SEAD-59 FD-71-CL-04 SOIL FD-71-CL-04 5/6/2004	SEAD-59 SB59-1 SOIL SB59-1-08 2/20/1994	SEAD-59 SB59-1 SOIL SB59-1-04 2/20/1994	SEAD-59 SB59-2 SOIL SB59-2-02 5/26/1994	SEAD-59 SB59-3 SOIL SB59-3-04 5/25/1994
Benzo(a)anthracene	UG/KG	71 NJ	16000 J	2500 J	140 J	5000	780	1600	360 U
Benzo(a)pyrene	UG/KG	65 J	14000 J	2600	110 J	5500 J	870	1500	360 U
Benzo(b)fluoranthene	UG/KG	86 J	12000 J	2000	130 J	5100 J	730	3100 J	360 U
Benzo(k)fluoranthene	UG/KG	30 J	13000 J	2100	77 J	6100 J	800	820 UJ	360 U
Chrysene	UG/KG	66 J	16000 J	2400	150 J	5100	930	1500	360 U
Dibenz(a,h)anthracene	UG/KG	340 U	2900 J	570 J	360 U	1900 UJ	420 U	470 J	360 U
Indeno(1,2,3-cd)pyrene	UG/KG	36 J	8700 J	1600 J	43 J	2200 J	400 J	940	360 U
BTE Concentration (ug/kg)		255.26	20860	3825	323.57	7792	1288.3	2553.1	417.6

Site Wide Surface Soil Average	
BTE Concentration (mg/kg)	1.37

Table A-7A
Benzo(a)pyrene Toxicity Equivalency for SEAD-59 Surface Soil (0-2 ft)
SEAD-59 and SEAD-71 Phase II RI Report
Seneca Army Depot Activity

	Facility	SEAD-59	SEAD-59	SEAD-59	SEAD-59	SEAD-59	SEAD-59	SEAD-59
	Location ID	CL-59-01-F09	CL-59-01-F10	CL-59-01-F11	CL-59-01-F12	CL-59-01-F13	CL-59-01-F14	CL-59-01-F15
	Matrix	SOIL	SOIL	SOIL	SOIL	SOIL	SOIL	SOIL
	Sample ID	CL-59-01-F09	CL-59-01-F10	CL-59-01-F11	CL-59-01-F12	CL-59-01-F13	CL-59-01-F14	CL-59-01-F15
	Sample Date	5/6/2004	5/6/2004	5/6/2004	5/6/2004	5/6/2004	5/6/2004	5/6/2004
Parameter	Units	Value (Q)	Value (Q)	Value (Q)	Value (Q)	Value (Q)	Value (Q)	Value (Q)
Benzo(a)anthracene	UG/KG	510 NJ	390 U	390 U	410 U	390 U	380 U	400 U
Benzo(a)pyrene	UG/KG	520	390 U	390 U	410 U	390 U	380 U	400 U
Benzo(b)fluoranthene	UG/KG	630	390 U	390 U	410 U	390 U	380 U	400 U
Benzo(k)fluoranthene	UG/KG	360 J	390 U	390 U	410 U	390 U	380 U	400 U
Chrysene	UG/KG	490	390 U	390 U	410 U	390 U	380 U	400 U
Dibenz(a,h)anthracene	UG/KG	39 J	390 U	390 U	410 U	390 U	380 U	400 U
Indeno(1,2,3-cd)pyrene	UG/KG	140 J	390 U	390 U	410 U	390 U	380 U	400 U
BTE Concentration (ug/kg)		695.5	452.4	452.4	475.6	452.4	440.8	464

	Facility	SEAD-59	SEAD-59	SEAD-59	SEAD-59	SEAD-59	SEAD-59	SEAD-59
	Location ID	SB59-4	SB59-4	SB59-5	SB59-18	SB59-20	SB59-21	SB59-8
	Matrix	SOIL	SOIL	SOIL	SOIL	SOIL	SOIL	SOIL
	Sample ID	SB59-4-05	SB59-4-10	SB59-5-03	59127	59066	59067	59057
	Sample Date	5/25/1994	5/25/1994	5/25/1994	10/24/1997	10/22/1997	10/22/1997	10/20/1997
Parameter	Units	Value (Q)	Value (Q)	Value (Q)	Value (Q)	Value (Q)	Value (Q)	Value (Q)
Benzo(a)anthracene	UG/KG	740	360 U	1400	620	20 J	9.6 J	6.6 J
Benzo(a)pyrene	UG/KG	360 J	360 U	1200 J	570	22 J	8.1 J	7 J
Benzo(b)fluoranthene	UG/KG	730	360 U	1100 J	920	19 J	15 J	7.7 J
Benzo(k)fluoranthene	UG/KG	590	360 U	870 J	380 U	20 J	12 J	8.4 J
Chrysene	UG/KG	820	360 U	1400	600	25 J	14 J	7.8 J
Dibenz(a,h)anthracene	UG/KG	160 J	360 U	300 J	150 J	4.7 J	66 U	81 U
Indeno(1,2,3-cd)pyrene	UG/KG	300 J	360 U	570 J	300 J	14 J	9.6 J	6 J
BTE Concentration (ug/kg)		711.1	417.6	1829.7	911.9	32.45	44.78	49.692

Site Wide Surface Soil Average	
BTE Concentration (mg/kg)	1.37

Table A-7A
Benzo(a)pyrene Toxicity Equivalency for SEAD-59 Surface Soil (0-2 ft)
SEAD-59 and SEAD-71 Phase II RI Report
Seneca Army Depot Activity

	Facility	SEAD-59	SEAD-59	SEAD-59	SEAD-59	SEAD-59	SEAD-59	SEAD-59
	Location ID	CL-59-01-F16	CL-59-01-F17	CL-59-01-F18	CL-59-01-F19	CL-59-01-F20	CL-59-01-F21	CL-59-01-F22
	Matrix	SOIL	SOIL	SOIL	SOIL	SOIL	SOIL	SOIL
	Sample ID	CL-59-01-F16	CL-59-01-F17	CL-59-01-F18	CL-59-01-F19	CL-59-01-F20	CL-59-01-F21	CL-59-01-F22
	Sample Date	5/6/2004	5/6/2004	5/6/2004	5/6/2004	5/6/2004	5/6/2004	5/6/2004
Parameter	Units	Value (Q)	Value (Q)	Value (Q)	Value (Q)	Value (Q)	Value (Q)	Value (Q)
Benzo(a)anthracene	UG/KG	360 U	360 U	380 U	390 U	380 U	390 U	390 U
Benzo(a)pyrene	UG/KG	360 U	360 U	380 U	390 U	380 U	390 U	390 U
Benzo(b)fluoranthene	UG/KG	360 U	360 U	380 U	390 U	380 U	390 U	390 U
Benzo(k)fluoranthene	UG/KG	360 U	360 U	380 U	390 U	380 U	390 U	390 U
Chrysene	UG/KG	360 U	360 U	380 U	390 U	380 U	390 U	390 U
Dibenz(a,h)anthracene	UG/KG	360 U	360 U	380 U	390 U	380 U	390 U	390 U
Indeno(1,2,3-cd)pyrene	UG/KG	360 U	360 U	380 U	390 U	380 U	390 U	390 U
BTE Concentration (ug/kg)		417.6	417.6	440.8	452.4	440.8	452.4	452.4

	Facility	SEAD-59	SEAD-59	SEAD-59	SEAD-59	SEAD-59	SEAD-59	SEAD-59
	Location ID	SB59-9	TP59-11A-2	TP59-15-5	TP59-17-3	TP59-8-2	TP59-9-2	WS-59-01-004-7
	Matrix	SOIL	SOIL	SOIL	SOIL	SOIL	SOIL	SOIL
	Sample ID	59059	59026	59035	59044	59050	59052	WS-59-01-004-7
	Sample Date	10/21/1997	10/9/1997	10/10/1997	10/13/1997	10/13/1997	10/13/1997	5/6/2004
Parameter	Units	Value (Q)	Value (Q)	Value (Q)	Value (Q)	Value (Q)	Value (Q)	Value (Q)
Benzo(a)anthracene	UG/KG	69 U	3500	3200	1000	200	320	280 J
Benzo(a)pyrene	UG/KG	69 U	4100	3600	1300	210	340	350 J
Benzo(b)fluoranthene	UG/KG	4.8 J	3400	3200	1000	230	320	250 J
Benzo(k)fluoranthene	UG/KG	69 U	3200	3100	1200	180	300	280 J
Chrysene	UG/KG	69 U	3700	4400	1100	220	360	330 J
Dibenz(a,h)anthracene	UG/KG	69 U	890 J	710 J	350 J	52 J	84 J	1200 U
Indeno(1,2,3-cd)pyrene	UG/KG	69 U	2300	2000	840	140 J	200	200 J
BTE Concentration (ug/kg)		77.07	5979	5225	1957	323	514.6	1029.1

Site Wide Surface Soil Average	
BTE Concentration (mg/kg)	1.37

Table A-7A
Benzo(a)pyrene Toxicity Equivalency for SEAD-59 Surface Soil (0-2 ft)
SEAD-59 and SEAD-71 Phase II RI Report
Seneca Army Depot Activity

Parameter	Units	SEAD-59 CL-59-01-F23 5/6/2004	SEAD-59 CL-59-01-F24 5/6/2004	SEAD-59 CL-59-01-F25 5/6/2004	SEAD-59 CL-59-01-F26 5/6/2004	SEAD-59 CL-59-01-WE1 5/6/2004	SEAD-59 CL-59-01-WE2 5/6/2004	SEAD-59 CL-59-01-WE3 5/6/2004	SEAD-59 CL-59-01-WE4 5/6/2004
Benzo(a)anthracene	UG/KG	380 U	390 U	370 U	380 U	430 U	420 U	410 U	460 U
Benzo(a)pyrene	UG/KG	380 U	390 U	60 J	380 U	430 U	420 U	410 U	460 U
Benzo(b)fluoranthene	UG/KG	380 U	390 U	68 J	380 U	430 U	420 U	410 U	460 U
Benzo(k)fluoranthene	UG/KG	380 U	390 U	25 J	380 U	430 U	420 U	410 U	460 U
Chrysene	UG/KG	380 U	390 U	370 U	380 U	430 U	420 U	410 U	460 U
Dibenz(a,h)anthracene	UG/KG	380 U	390 U	370 U	380 U	430 U	420 U	410 U	460 U
Indeno(1,2,3-cd)pyrene	UG/KG	380 U	390 U	370 U	380 U	430 U	420 U	410 U	460 U
BTE Concentration (ug/kg)		440.8	452.4	290.9	440.8	498.8	487.2	475.6	533.6

Parameter	Units	SEAD-59 WS-59-01-006-11 5/6/2004	SEAD-59 WS-59-01-006-2 5/6/2004	SEAD-59 WS-59-01-006-4 5/6/2004	SEAD-59 WS-59-01-006-5 5/6/2004	SEAD-59 WS-59-01-006-6 5/6/2004	SEAD-59 WS-59-01-006-8 5/6/2004	SEAD-59 WS-59-01-007-3 5/6/2004	SEAD-59 WS-59-01-007-4 5/6/2004
Benzo(a)anthracene	UG/KG	3200	2000	2500	3100	1300	2000	3100	2000 J
Benzo(a)pyrene	UG/KG	3800	2800	3100	3900	1600	2300	3200	2400
Benzo(b)fluoranthene	UG/KG	2700	2000	2200	2600	1100 J	1700 J	2500	1800 J
Benzo(k)fluoranthene	UG/KG	2600	1900	2200	2800	1100 J	1500 J	2600	1800 J
Chrysene	UG/KG	3200	2100	2500	3100	1200	1900	3200	2000
Dibenz(a,h)anthracene	UG/KG	900 J	630 J	710 J	940 J	400 J	510 J	710 J	510 J
Indeno(1,2,3-cd)pyrene	UG/KG	2600 J	1900 J	2000 J	2600 J	1100 J	1700 J	1900 J	1500 J
BTE Concentration (ug/kg)		5608	4060	4527	5729	2373	3384	4718	3478

Site Wide Surface Soil Average
BTE Concentration (mg/kg) 1.37

Table A-7A
Benzo(a)pyrene Toxicity Equivalency for SEAD-59 Surface Soil (0-2 ft)
SEAD-59 and SEAD-71 Phase II RI Report
Seneca Army Depot Activity

Parameter	Units	SEAD-59 CL-59-01-WE5 5/6/2004 Value (Q)	SEAD-59 CL-59-01-WN1 5/6/2004 Value (Q)	SEAD-59 CL-59-01-WN2 5/6/2004 Value (Q)	SEAD-59 CL-59-01-WN3 5/6/2004 Value (Q)	SEAD-59 CL-59-01-WN4 5/6/2004 Value (Q)	SEAD-59 CL-59-01-WN5 5/6/2004 Value (Q)	SEAD-59 CL-59-01-WN6 5/6/2004 Value (Q)	SEAD-59 CL-59-01-WS1 5/6/2004 Value (Q)
Benzo(a)anthracene	UG/KG	390 U	360 U	360 J	670 NJ	600 NJ	62 NJ	170 NJ	390 U
Benzo(a)pyrene	UG/KG	390 U	360 U	330 J	620	640	53 J	240 J	390 U
Benzo(b)fluoranthene	UG/KG	390 U	360 U	670	1000	720	67 J	300 J	390 U
Benzo(k)fluoranthene	UG/KG	390 U	360 U	220 J	370 J	310 J	400 U	120 J	390 U
Chrysene	UG/KG	390 U	360 U	550 NJ	700	590	60 J	180 J	390 U
Dibenz(a,h)anthracene	UG/KG	390 U	360 U	67 J	89 J	99 J	400 U	38 J	390 U
Indeno(1,2,3-cd)pyrene	UG/KG	390 U	360 U	270 J	340 J	390 J	400 U	170 J	390 U
BTE Concentration (ug/kg)		452.4	417.6	534.7	920.7	919	288.5	345	452.4

Parameter	Units	SEAD-59 WS-59-01-007-7 5/6/2004 Value (Q)	SEAD-59 WS-59-01-007-9 5/6/2004 Value (Q)	SEAD-59 WS-59-01-011-3 5/6/2004 Value (Q)	SEAD-59 WS-59-01-011-4 5/6/2004 Value (Q)	SEAD-59 WS-59-01-012-1 5/6/2004 Value (Q)	SEAD-59 WS-59-01-013-1 5/6/2004 Value (Q)	SEAD-59 WS-59-01-013-3 5/6/2004 Value (Q)	SEAD-59 WS-59-01-013-4 5/6/2004 Value (Q)
Benzo(a)anthracene	UG/KG	2200 J	2900	2600	2200	1800 NJ	7800	2800	1100
Benzo(a)pyrene	UG/KG	2500 J	3000	3000	2500	2100 J	7000	2900	1400
Benzo(b)fluoranthene	UG/KG	2000 J	2100	3500	2900	2300 J	5200	2300	1100
Benzo(k)fluoranthene	UG/KG	2000 J	2400	1500 J	1100 J	980 J	5600	2500	1100
Chrysene	UG/KG	2200 J	2900	2500	2100	1800 J	7500	2900	1300
Dibenz(a,h)anthracene	UG/KG	460 J	640 J	520 J	410 J	320 J	1400 J	620 J	310 J
Indeno(1,2,3-cd)pyrene	UG/KG	1300 J	1800 J	1900	1600 J	1200 J	3700 J	1700 J	920 J
BTE Concentration (ug/kg)		3552	4373	4360	3612	2977.8	10201	4254	2046

Site Wide Surface Soil Average	
BTE Concentration (mg/kg)	1.37

Table A-7A
Benzo(a)pyrene Toxicity Equivalency for SEAD-59 Surface Soil (0-2 ft)
SEAD-59 and SEAD-71 Phase II RI Report
Seneca Army Depot Activity

Facility	SEAD-59	SEAD-59	SEAD-59	SEAD-59	SEAD-59	SEAD-59	SEAD-59	SEAD-59	
Location ID	CL-59-01-WS2	CL-59-01-WS3	CL-59-01-WS4	CL-59-01-WS5	CL-59-01-WS6	CL-59-01-WW1	CL-59-01-WW2	CL-59-01-WW3	
Matrix	SOIL	SOIL	SOIL	SOIL	SOIL	SOIL	SOIL	SOIL	
Sample ID	CL-59-01-WS2	CL-59-01-WS3	CL-59-01-WS4	CL-59-01-WS5	CL-59-01-WS6	CL-59-01-WW1	CL-59-01-WW2	CL-59-01-WW3	
Sample Date	5/6/2004	5/6/2004	5/6/2004	5/6/2004	5/6/2004	5/6/2004	5/6/2004	5/6/2004	
Parameter	Units	Value (Q)	Value (Q)	Value (Q)	Value (Q)	Value (Q)	Value (Q)	Value (Q)	
Benzo(a)anthracene	UG/KG	380 U	360 U	380 U	360 J	380 U	390 U	380 U	370 U
Benzo(a)pyrene	UG/KG	380 U	360 U	380 U	360 J	380 U	390 U	380 U	370 U
Benzo(b)fluoranthene	UG/KG	380 U	360 U	380 U	510	380 U	390 U	380 U	370 U
Benzo(k)fluoranthene	UG/KG	380 U	360 U	380 U	200 J	380 U	390 U	380 U	370 U
Chrysene	UG/KG	380 U	360 U	380 U	410	380 U	390 U	380 U	370 U
Dibenz(a,h)anthracene	UG/KG	380 U	360 U	380 U	58 J	380 U	390 U	380 U	370 U
Indeno(1,2,3-cd)pyrene	UG/KG	380 U	360 U	380 U	210 J	380 U	390 U	380 U	370 U
BTE Concentration (ug/kg)		440.8	417.6	440.8	532.1	440.8	452.4	440.8	429.2

Facility	SEAD-59	SEAD-59	SEAD-59	SEAD-59	SEAD-59	SEAD-59	SEAD-59	SEAD-59	
Location ID	WS-59-01-013-5	WS-59-01-013-6	WS-59-01-013-7	WS-59-01-014-1	WS-59-01-014-2	WS-59-01-014-3	WS-59-01-014-4	WS-59-01-015-1	
Matrix	SOIL	SOIL	SOIL	SOIL	SOIL	SOIL	SOIL	SOIL	
Sample ID	WS-59-01-013-5	WS-59-01-013-6	WS-59-01-013-7	WS-59-01-014-1	WS-59-01-014-2	WS-59-01-014-3	WS-59-01-014-4	WS-59-01-015-1	
Sample Date	5/6/2004	5/6/2004	5/6/2004	5/6/2004	5/6/2004	5/6/2004	5/6/2004	5/6/2004	
Parameter	Units	Value (Q)	Value (Q)	Value (Q)	Value (Q)	Value (Q)	Value (Q)	Value (Q)	
Benzo(a)anthracene	UG/KG	1600 J	2300	1300	490 NJ	1400 NJ	270 J	1000 NJ	3000
Benzo(a)pyrene	UG/KG	2000	2700	1400	650 J	2100 J	360 J	890	2700
Benzo(b)fluoranthene	UG/KG	1700 J	2100	1200	830 J	2700 J	450 J	1100	2100
Benzo(k)fluoranthene	UG/KG	1600 J	2300	1200	440 J	990 J	280 NJ	440	2500
Chrysene	UG/KG	1800 J	2300	1300	550 J	1600 J	330 J	970	2900
Dibenz(a,h)anthracene	UG/KG	460 J	650 J	320 J	100 J	320 J	66 J	120 J	580 J
Indeno(1,2,3-cd)pyrene	UG/KG	1300 J	1900 J	880 J	380 J	1100 J	200 J	450	1500 J
BTE Concentration (ug/kg)		2954	4026	2083	929.9	2965.9	524.1	1279.1	3994

Site Wide Surface Soil Average
BTE Concentration (mg/kg) 1.37

Table A-7A
Benzo(a)pyrene Toxicity Equivalency for SEAD-59 Surface Soil (0-2 ft)
SEAD-59 and SEAD-71 Phase II RI Report
Seneca Army Depot Activity

Parameter	Units	Facility	SEAD-59	SEAD-59	SEAD-59	SEAD-59	SEAD-59	SEAD-59	SEAD-59	
		Location ID	CL-59-01-WW4	CL-59-02-F01	CL-59-02-F02	CL-59-02-WE1	CL-59-02-WE2	CL-59-02-WN1	CL-59-02-WN2	CL-59-02-WS1
		Matrix	SOIL	SOIL	SOIL	SOIL	SOIL	SOIL	SOIL	
		Sample ID	CL-59-01-WW4	CL-59-02-F01	CL-59-02-F02	CL-59-02-WE1	CL-59-02-WE2	CL-59-02-WN1	CL-59-02-WN2	CL-59-02-WS1
		Sample Date	5/6/2004	5/6/2004	5/6/2004	5/6/2004	5/6/2004	5/6/2004	5/6/2004	5/6/2004
		Value (Q)	Value (Q)	Value (Q)	Value (Q)	Value (Q)	Value (Q)	Value (Q)	Value (Q)	
Benzo(a)anthracene	UG/KG	210 J	370 U	380 U	380 U	360 U	400 U	350 U	360 U	
Benzo(a)pyrene	UG/KG	220 J	370 U	380 U	380 U	360 U	400 U	350 U	360 U	
Benzo(b)fluoranthene	UG/KG	280 J	370 U	380 U	380 U	360 U	400 U	350 U	360 U	
Benzo(k)fluoranthene	UG/KG	100 J	370 U	380 U	380 U	360 U	400 U	350 U	360 U	
Chrysene	UG/KG	230 NJ	370 U	380 U	380 U	360 U	400 U	350 U	360 U	
Dibenz(a,h)anthracene	UG/KG	32 NJ	370 U	380 U	380 U	360 U	400 U	350 U	360 U	
Indeno(1,2,3-cd)pyrene	UG/KG	130 J	370 U	380 U	380 U	360 U	400 U	350 U	360 U	
BTE Concentration (ug/kg)		317.3	429.2	440.8	440.8	417.6	464	406	417.6	

Parameter	Units	Facility	SEAD-59	SEAD-59	SEAD-59	SEAD-59	SEAD-59	SEAD-59	SEAD-59	
		Location ID	WS-59-01-015-10	WS-59-01-015-11	WS-59-01-015-13	WS-59-01-015-18	WS-59-01-015-19	WS-59-01-015-2	WS-59-01-015-5	WS-59-01-015-6
		Matrix	SOIL	SOIL	SOIL	SOIL	SOIL	SOIL	SOIL	
		Sample ID	WS-59-01-015-10	WS-59-01-015-11	WS-59-01-015-13	WS-59-01-015-18	WS-59-01-015-19	WS-59-01-015-2	WS-59-01-015-5	WS-59-01-015-6
		Sample Date	5/6/2004	5/6/2004	5/6/2004	5/6/2004	5/6/2004	5/6/2004	5/6/2004	5/6/2004
		Value (Q)	Value (Q)	Value (Q)	Value (Q)	Value (Q)	Value (Q)	Value (Q)	Value (Q)	
Benzo(a)anthracene	UG/KG	1700 J	1900 J	1800 J	3100	3600	1900 J	2200	2700	
Benzo(a)pyrene	UG/KG	2000	2300	2100 J	3600	3800	2000	2500	2900	
Benzo(b)fluoranthene	UG/KG	1500 J	1800 J	1600 J	2900	2900	1700 J	2000 J	2200	
Benzo(k)fluoranthene	UG/KG	1600 J	1800 J	1700 J	3000	3100	1700 J	2100	2300	
Chrysene	UG/KG	1700 NJ	1900 NJ	1800 J	3500	3600	1900 NJ	2300	2700 NJ	
Dibenz(a,h)anthracene	UG/KG	390 J	450 J	430 J	660 J	660 J	410 J	500 J	590 J	
Indeno(1,2,3-cd)pyrene	UG/KG	1100 J	1400 J	1200 J	1800 J	1800 J	1200 J	1600 J	1800 J	
BTE Concentration (ug/kg)		2853	3297	3025	5105	5357	2926	3624	4210	

Site Wide Surface Soil Average
BTE Concentration (mg/kg) 1.37

Table A-7A
Benzo(a)pyrene Toxicity Equivalency for SEAD-59 Surface Soil (0-2 ft)
SEAD-59 and SEAD-71 Phase II RI Report
Seneca Army Depot Activity

Parameter	Units	SEAD-59 CL-59-02-WS2 SOIL 5/6/2004	SEAD-59 CL-59-02-WW1 SOIL 5/6/2004	SEAD-59 CL-59-02-WW2 SOIL 5/6/2004	SEAD-59 CL-59-03-F01 SOIL 5/6/2004	SEAD-59 CL-59-03-F02 SOIL 5/6/2004	SEAD-59 CL-59-03-F03 SOIL 5/6/2004	SEAD-59 CL-59-03-WE1 SOIL 5/6/2004	SEAD-59 CL-59-03-WN1 SOIL 5/6/2004
Benzo(a)anthracene	UG/KG	370 U	360 U	390 U	400 U	420 U	380 U	370 U	360 U
Benzo(a)pyrene	UG/KG	370 U	360 U	390 U	400 U	420 U	380 U	370 U	360 U
Benzo(b)fluoranthene	UG/KG	370 U	360 U	390 U	400 U	420 U	380 U	370 U	360 U
Benzo(k)fluoranthene	UG/KG	370 U	360 U	390 U	400 U	420 U	380 U	370 U	360 U
Chrysene	UG/KG	370 U	360 U	390 U	400 U	420 U	380 U	370 U	360 U
Dibenz(a,h)anthracene	UG/KG	370 U	360 U	390 U	400 U	420 U	380 U	370 U	360 U
Indeno(1,2,3-cd)pyrene	UG/KG	370 U	360 U	390 U	400 U	420 U	380 U	370 U	360 U
BTE Concentration (ug/kg)		429.2	417.6	452.4	464	487.2	440.8	429.2	417.6

Parameter	Units	SEAD-59 WS-59-01-015-7 SOIL 5/6/2004	SEAD-59 WS-59-01-015-9 SOIL 5/6/2004	SEAD-59 WS-59-01-016-11 SOIL 5/6/2004	SEAD-59 WS-59-01-016-12 SOIL 5/6/2004	SEAD-59 WS-59-01-016-15 SOIL 5/6/2004	SEAD-59 WS-59-01-016-16 SOIL 5/6/2004	SEAD-59 WS-59-01-016-17 SOIL 5/6/2004	SEAD-59 WS-59-01-016-7 SOIL 5/6/2004
Benzo(a)anthracene	UG/KG	1700 J	1900 J	700 J	1100 J	780 J	1000 J	3100 J	390 J
Benzo(a)pyrene	UG/KG	1800 J	2400 J	670 J	940 J	870 J	1000 J	3600 J	390 J
Benzo(b)fluoranthene	UG/KG	1400 J	1900 J	570 J	740 J	670 J	870 J	2600 J	380 J
Benzo(k)fluoranthene	UG/KG	1400 J	1800 J	630 J	840 J	720 J	900 J	2700 J	350 J
Chrysene	UG/KG	1800 NJ	2000 J	710 J	1100 J	860 J	1200 J	3000 J	450 J
Dibenz(a,h)anthracene	UG/KG	360 J	490 J	160 J	190 J	150 NJ	210 J	740 J	2000 U
Indeno(1,2,3-cd)pyrene	UG/KG	1100 J	1400 J	450 J	580 J	530 J	640 J	2100 J	280 J
BTE Concentration (ug/kg)		2612	3448	1015.4	1391.4	1233.8	1482	5177	1503

Site Wide Surface Soil Average	
BTE Concentration (mg/kg)	1.37

Table A-7A
Benzo(a)pyrene Toxicity Equivalency for SEAD-59 Surface Soil (0-2 ft)
SEAD-59 and SEAD-71 Phase II RI Report
Seneca Army Depot Activity

Parameter	Facility	SEAD-59	SEAD-59	SEAD-59	SEAD-59	SEAD-59	SEAD-59	SEAD-59	SEAD-59
Units	Location ID	CL-59-03-WN2	CL-59-03-WN3	CL-59-03-WS1	CL-59-03-WS2	CL-59-03-WS3	CL-59-03-WW1	CL-59-04-F04	CL-59-04-FO1
Value (Q)	Matrix	SOIL	SOIL	SOIL	SOIL	SOIL	SOIL	SOIL	SOIL
Value (Q)	Sample ID	CL-59-03-WN2	CL-59-03-WN3	CL-59-03-WS1	CL-59-03-WS2	CL-59-03-WS3	CL-59-03-WW1	CL-59-04-F04	CL-59-04-FO1
Value (Q)	Sample Date	5/6/2004	5/6/2004	5/6/2004	5/6/2004	5/6/2004	5/6/2004	5/6/2004	5/6/2004
Benzo(a)anthracene	UG/KG	350 U	370 U	360 U	350 U	350 U	400 U	380 U	360 U
Benzo(a)pyrene	UG/KG	350 U	370 U	360 U	350 U	350 U	400 U	380 U	360 U
Benzo(b)fluoranthene	UG/KG	350 U	370 U	360 U	350 U	350 U	400 U	380 U	360 U
Benzo(k)fluoranthene	UG/KG	350 U	370 U	360 U	350 U	350 U	400 U	380 U	360 U
Chrysene	UG/KG	350 U	370 U	360 U	350 U	350 U	400 U	380 U	360 U
Dibenz(a,h)anthracene	UG/KG	350 U	370 U	360 U	350 U	350 U	400 U	380 U	360 U
Indeno(1,2,3-cd)pyrene	UG/KG	350 U	370 U	360 U	350 U	350 U	400 U	380 U	360 U
BTE Concentration (ug/kg)		406	429.2	417.6	406	406	464	440.8	417.6

Parameter	Facility	SEAD-59	SEAD-59	SEAD-59	SEAD-59	SEAD-59	SEAD-59	SEAD-59	SEAD-59
Units	Location ID	WS-59-01-016-8	WS-59-01-017-1	WS-59-01-017-2	WS-59-01-018-1	WS-59-01-018-2	WS-59-01-018-3	WS-59-01-018-4	WS-59-01-018-5
Value (Q)	Matrix	SOIL	SOIL	SOIL	SOIL	SOIL	SOIL	SOIL	SOIL
Value (Q)	Sample ID	WS-59-01-016-8	WS-59-01-017-1	WS-59-01-017-2	WS-59-01-018-1	WS-59-01-018-2	WS-59-01-018-3	WS-59-01-018-4	WS-59-01-018-5
Value (Q)	Sample Date	5/6/2004	5/6/2004	5/6/2004	5/6/2004	5/6/2004	5/6/2004	5/6/2004	5/6/2004
Benzo(a)anthracene	UG/KG	810 J	1100 J	1900 J	2600 J	1400 J	420 J	340 J	620 J
Benzo(a)pyrene	UG/KG	910 J	1500 J	2100 J	2800 J	1500 J	470 J	290 J	660 J
Benzo(b)fluoranthene	UG/KG	700 J	1300 J	1700 J	2100 J	1200 J	410 J	270 J	500 J
Benzo(k)fluoranthene	UG/KG	760 J	1200 J	1800 J	2000 J	1200 J	430 J	290 J	530 J
Chrysene	UG/KG	900 J	1300 J	2100 J	2900 J	1600 J	480 J	360 J	730 J
Dibenz(a,h)anthracene	UG/KG	200 J	340 J	420 J	530 J	220 J	1200 U	1200 U	150 J
Indeno(1,2,3-cd)pyrene	UG/KG	590 J	950 J	1300 J	1500 J	970 J	310 J	190 J	400 J
BTE Concentration (ug/kg)		1336.6	2200	3049	3999	2105	1193.1	976.5	974.6

Site Wide Surface Soil Average	
BTE Concentration (mg/kg)	1.37

Table A-7A
Benzo(a)pyrene Toxicity Equivalency for SEAD-59 Surface Soil (0-2 ft)
SEAD-59 and SEAD-71 Phase II RI Report
Seneca Army Depot Activity

Parameter	Units	SEAD-59 CL-59-04-WE1 SOIL CL-59-04-WE1 5/6/2004	SEAD-59 CL-59-04-WN1 SOIL CL-59-04-WN1 5/6/2004	SEAD-59 CL-59-04-WN2 SOIL CL-59-04-WN2 5/6/2004	SEAD-59 CL-59-04-WS1 SOIL CL-59-04-WS1 5/6/2004	SEAD-59 CL-59-04-WS2 SOIL CL-59-04-WS2 5/6/2004	SEAD-59 CL-59-04-WW1 SOIL CL-59-04-WW1 5/6/2004	SEAD-59 CL-59-OTHERA-F01 SOIL CL-59-OTHERA-F01 5/6/2004	SEAD-59 CL-59-OTHERA-WE1 SOIL CL-59-OTHERA-WE1 5/6/2004
Benzo(a)anthracene	UG/KG	390 U	390 U	360 U	370 U	370 U	370 U	350 U	370 U
Benzo(a)pyrene	UG/KG	390 U	390 U	360 U	370 U	370 U	370 U	350 U	370 U
Benzo(b)fluoranthene	UG/KG	390 U	390 U	360 U	370 U	370 U	370 U	350 U	370 U
Benzo(k)fluoranthene	UG/KG	390 U	390 U	360 U	370 U	370 U	370 U	350 U	370 U
Chrysene	UG/KG	390 U	390 U	360 U	370 U	370 U	370 U	350 U	370 U
Dibenz(a,h)anthracene	UG/KG	390 U	390 U	360 U	370 U	370 U	370 U	350 U	370 U
Indeno(1,2,3-cd)pyrene	UG/KG	390 U	390 U	360 U	370 U	370 U	370 U	350 U	370 U
BTE Concentration (ug/kg)		452.4	452.4	417.6	429.2	429.2	429.2	406	429.2

Parameter	Units	SEAD-59 WS-59-01-018-6 SOIL WS-59-01-018-6 5/6/2004	SEAD-59 WS-59-01-018-7 SOIL WS-59-01-018-7 5/6/2004	SEAD-59 WS-59-01-018-8 SOIL WS-59-01-018-8 5/6/2004	SEAD-59 WS-59-02-002-1 SOIL WS-59-02-002-1 5/6/2004	SEAD-59 WS-59-02-002-2 SOIL WS-59-02-002-2 5/6/2004	SEAD-59 WS-59-02-002-3 SOIL WS-59-02-002-3 5/6/2004	SEAD-59 WS-59-02-003-1 SOIL WS-59-02-003-1 5/6/2004	SEAD-59 WS-59-02-003-2 SOIL WS-59-02-003-2 5/6/2004
Benzo(a)anthracene	UG/KG	1400 J	480 J	320 J	370 U	370 U	370 U	54 J	130 J
Benzo(a)pyrene	UG/KG	1400 J	500 J	360 J	370 U	370 U	370 U	49 J	120 J
Benzo(b)fluoranthene	UG/KG	1200 J	670 J	480 J	370 U	370 U	370 U	45 J	100 J
Benzo(k)fluoranthene	UG/KG	1100 J	260 J	200 J	370 U	370 U	370 U	46 J	110 J
Chrysene	UG/KG	1700 J	570 J	380 J	370 U	370 U	370 U	71 J	130 J
Dibenz(a,h)anthracene	UG/KG	270 J	74 J	54 J	370 U	370 U	370 U	380 U	380 U
Indeno(1,2,3-cd)pyrene	UG/KG	820 J	320 J	240 J	370 U	370 U	370 U	380 U	66 J
BTE Concentration (ug/kg)		2040	729.3	523.8	429.2	429.2	429.2	269.07	342

Site Wide Surface Soil Average	
BTE Concentration (mg/kg)	1.37

Table A-7A
Benzo(a)pyrene Toxicity Equivalency for SEAD-59 Surface Soil (0-2 ft)
SEAD-59 and SEAD-71 Phase II RI Report
Seneca Army Depot Activity

	Facility	SEAD-59	SEAD-59	SEAD-59	SEAD-59	SEAD-59	SEAD-59
	Location ID	CL-59-OTHERA-WN1	CL-59-OTHERA-WS1	CL-59-OTHERA-WW1	CL-59-OTHERB-F01	CL-59-OTHERB-WE1	CL-59-OTHERB-WN1
	Matrix	SOIL	SOIL	SOIL	SOIL	SOIL	SOIL
	Sample ID	CL-59-OTHERA-WN1	CL-59-OTHERA-WS1	CL-59-OTHERA-WW1	CL-59-OTHERB-F01	CL-59-OTHERB-WE1	CL-59-OTHERB-WN1
	Sample Date	5/6/2004	5/6/2004	5/6/2004	5/6/2004	5/6/2004	5/6/2004
Parameter	Units	Value (Q)	Value (Q)	Value (Q)	Value (Q)	Value (Q)	Value (Q)
Benzo(a)anthracene	UG/KG	390 U	360 U	370 U	360 U	370 U	370 U
Benzo(a)pyrene	UG/KG	390 U	360 U	370 U	360 U	370 U	370 U
Benzo(b)fluoranthene	UG/KG	390 U	360 U	370 U	360 U	370 U	370 U
Benzo(k)fluoranthene	UG/KG	390 U	360 U	370 U	360 U	370 U	370 U
Chrysene	UG/KG	390 U	360 U	370 U	360 U	370 U	370 U
Dibenz(a,h)anthracene	UG/KG	390 U	360 U	370 U	360 U	370 U	370 U
Indeno(1,2,3-cd)pyrene	UG/KG	390 U	360 U	370 U	360 U	370 U	370 U
BTE Concentration (ug/kg)		452.4	417.6	429.2	417.6	429.2	429.2

	Facility	SEAD-59	SEAD-59	SEAD-59	SEAD-59	SEAD-59	SEAD-59
	Location ID	WS-59-02-003-3	WS-59-02-003-4	WS-59-02-003-5	WS-59-02-004-1	WS-59-03-001-1	WS-59-03-001-2
	Matrix	SOIL	SOIL	SOIL	SOIL	SOIL	SOIL
	Sample ID	WS-59-02-003-3	WS-59-02-003-4	WS-59-02-003-5	WS-59-02-004-1	WS-59-03-001-1	WS-59-03-001-2
	Sample Date	5/6/2004	5/6/2004	5/6/2004	5/6/2004	5/6/2004	5/6/2004
Parameter	Units	Value (Q)	Value (Q)	Value (Q)	Value (Q)	Value (Q)	Value (Q)
Benzo(a)anthracene	UG/KG	380 U	44 J	110 J	380 U	210 J	380 U
Benzo(a)pyrene	UG/KG	380 U	46 J	120 J	380 U	180 J	380 U
Benzo(b)fluoranthene	UG/KG	380 U	42 J	110 J	380 U	160 J	380 U
Benzo(k)fluoranthene	UG/KG	380 U	42 J	110 J	380 U	160 J	380 U
Chrysene	UG/KG	380 U	51 J	130 J	380 U	240 J	380 U
Dibenz(a,h)anthracene	UG/KG	380 U	380 U	370 U	380 U	370 UJ	380 U
Indeno(1,2,3-cd)pyrene	UG/KG	380 U	380 U	74 J	380 U	120 J	380 U
BTE Concentration (ug/kg)		440.8	264.53	336.8	440.8	418	440.8

Site Wide Surface Soil Average
BTE Concentration (mg/kg) 1.37

Table A-7A
Benzo(a)pyrene Toxicity Equivalency for SEAD-59 Surface Soil (0-2 ft)
SEAD-59 and SEAD-71 Phase II RI Report
Seneca Army Depot Activity

Parameter	Facility	SEAD-59	SEAD-59	SEAD-59	SEAD-59	SEAD-59	SEAD-59
	Location ID	CL-59-OTHERB-WS1	CL-59-OTHERB-WW1	CL-59-OTHERC-F01	CL-59-OTHERC-WE2	CL-59-OTHERC-WN1	CL-59-OTHERC-WS1
	Matrix	SOIL	SOIL	SOIL	SOIL	SOIL	SOIL
	Sample ID	CL-59-OTHERB-WS1	CL-59-OTHERB-WW1	CL-59-OTHERC-F01	CL-59-OTHERC-WE2	CL-59-OTHERC-WN1	CL-59-OTHERC-WS1
	Sample Date	5/6/2004	5/6/2004	5/6/2004	5/6/2004	5/6/2004	5/6/2004
Units	Value (Q)	Value (Q)	Value (Q)	Value (Q)	Value (Q)	Value (Q)	
Benzo(a)anthracene	UG/KG	350 U	100 J	360 U	95 J	130 J	69 J
Benzo(a)pyrene	UG/KG	350 U	120 J	360 U	97 J	130 J	61 NJ
Benzo(b)fluoranthene	UG/KG	350 U	150 J	360 U	140 J	120 J	67 J
Benzo(k)fluoranthene	UG/KG	350 U	100 J	360 U	85 NJ	120 J	400 U
Chrysene	UG/KG	350 U	120 J	360 U	110 J	170 J	89 J
Dibenz(a,h)anthracene	UG/KG	350 U	350 U	360 U	360 U	350 UJ	400 U
Indeno(1,2,3-cd)pyrene	UG/KG	350 U	350 U	360 U	360 U	75 J	400 U
BTE Concentration (ug/kg)		406	339.7	417.6	320.45	340.4	297.49

Parameter	Facility	SEAD-59	SEAD-59	SEAD-59	SEAD-59	SEAD-59	SEAD-59
	Location ID	WS-59-03-001-3	WS-59-03-002-1	WS-59-03-002-2	WS-59-03-002-3	WS-59-03-002-4	WS-59-04-010-1
	Matrix	SOIL	SOIL	SOIL	SOIL	SOIL	SOIL
	Sample ID	WS-59-03-001-3	WS-59-03-002-1	WS-59-03-002-2	WS-59-03-002-3	WS-59-03-002-4	WS-59-04-010-1
	Sample Date	5/6/2004	5/6/2004	5/6/2004	5/6/2004	5/6/2004	5/6/2004
Units	Value (Q)	Value (Q)	Value (Q)	Value (Q)	Value (Q)	Value (Q)	
Benzo(a)anthracene	UG/KG	59 J	380 U	380 U	380 U	380 U	70 J
Benzo(a)pyrene	UG/KG	61 J	380 U	380 U	380 U	41 J	75 J
Benzo(b)fluoranthene	UG/KG	61 J	380 U	380 U	380 U	41 J	97 J
Benzo(k)fluoranthene	UG/KG	50 J	380 U	380 U	380 U	380 U	43 J
Chrysene	UG/KG	69 J	380 U	380 U	380 U	46 J	76 J
Dibenz(a,h)anthracene	UG/KG	380 U	380 U	380 U	380 U	380 U	350 U
Indeno(1,2,3-cd)pyrene	UG/KG	380 U	380 U	380 U	380 U	380 U	45 J
BTE Concentration (ug/kg)		283.19	440.8	440.8	440.8	275.46	272.39

Site Wide Surface Soil Average
BTE Concentration (mg/kg) 1.37

Table A-7A
Benzo(a)pyrene Toxicity Equivalency for SEAD-59 Surface Soil (0-2 ft)
SEAD-59 and SEAD-71 Phase II RI Report
Seneca Army Depot Activity

Parameter	Units	SEAD-59 CL-59-OTHERC-WW1 5/6/2004	SEAD-59 FD-59-CL-01 5/6/2004	SEAD-59 FD-59-CL-02 5/6/2004	SEAD-59 FD-59-CL-05 5/6/2004	SEAD-59 FD-59-CL-06 5/6/2004	SEAD-59 FD-59-CL-3 5/6/2004	SEAD-59 FD-59-CL-7 5/6/2004	SEAD-59 FD-59-W5-6 5/6/2004
Benzo(a)anthracene	UG/KG	370 U	190 J	370 U	150 J	360 U	370 U	390 U	7900 NJ
Benzo(a)pyrene	UG/KG	370 U	180 J	370 U	180 J	360 U	370 U	390 U	8400 J
Benzo(b)fluoranthene	UG/KG	370 U	160 J	370 U	120 J	360 U	370 U	390 U	8600 J
Benzo(k)fluoranthene	UG/KG	370 U	170 J	370 U	130 J	360 U	370 U	390 U	5300 J
Chrysene	UG/KG	370 U	210 J	370 U	150 J	360 U	370 U	390 U	7700 J
Dibenz(a,h)anthracene	UG/KG	370 U	380 U	370 U	44 J	360 U	370 U	390 U	1100 J
Indeno(1,2,3-cd)pyrene	UG/KG	370 U	130 J	370 U	100 J	360 U	370 U	390 U	2500 J
BTE Concentration (ug/kg)		429.2	421.8	429.2	263.8	417.6	429.2	452.4	11530

Parameter	Units	SEAD-59 WS-59-04-010-10 5/6/2004	SEAD-59 WS-59-04-010-11 5/6/2004	SEAD-59 WS-59-04-010-3 5/6/2004	SEAD-59 WS-59-04-010-4 5/6/2004	SEAD-59 WS-59-04-010-5 5/6/2004	SEAD-59 WS-59-04-010-6 5/6/2004	SEAD-59 WS-59-04-010-7 5/6/2004	SEAD-59 WS-59-04-010-9 5/6/2004
Benzo(a)anthracene	UG/KG	130 J	370 U	77 J	1100	2000	1300	360 J	690
Benzo(a)pyrene	UG/KG	140 J	370 U	78 J	990	1800	1200	330 J	660
Benzo(b)fluoranthene	UG/KG	200 J	370 U	100 J	1200	2100	1400	400	830
Benzo(k)fluoranthene	UG/KG	72 J	370 U	40 J	470	920	530	170 J	340 J
Chrysene	UG/KG	150 J	370 U	82 J	990	1900	1200 NJ	330 J	620
Dibenz(a,h)anthracene	UG/KG	370 U	370 U	380 U	140 J	270 J	190 J	56 J	94 J
Indeno(1,2,3-cd)pyrene	UG/KG	93 J	370 U	47 J	530	970	690	200 J	380
BTE Concentration (ug/kg)		369.52	429.2	291.62	1427.6	2605.2	1746.3	487	953.6

Site Wide Surface Soil Average BTE Concentration (mg/kg)	1.37
---	-------------

Table A-7A
Benzo(a)pyrene Toxicity Equivalency for SEAD-59 Surface Soil (0-2 ft)
SEAD-59 and SEAD-71 Phase II RI Report
Seneca Army Depot Activity

Facility SEAD-59
Location ID FD-59-WS-01
Matrix SOIL
Sample ID FD-59-WS-01
Sample Date 5/6/2004

Parameter	Units	Value (Q)
Benzo(a)anthracene	UG/KG	76 J
Benzo(a)pyrene	UG/KG	82 J
Benzo(b)fluoranthene	UG/KG	72 J
Benzo(k)fluoranthene	UG/KG	70 J
Chrysene	UG/KG	90 J
Dibenz(a,h)anthracene	UG/KG	380 U
Indeno(1,2,3-cd)pyrene	UG/KG	45 J
BTE Concentration (ug/kg)		292.9

Facility SEAD-59
Location ID WS-59-OTHERC-001-1
Matrix SOIL
Sample ID WS-59-OTHERC-001-1
Sample Date 5/6/2004

Parameter	Units	Value (Q)
Benzo(a)anthracene	UG/KG	66 J
Benzo(a)pyrene	UG/KG	380 U
Benzo(b)fluoranthene	UG/KG	66 J
Benzo(k)fluoranthene	UG/KG	76 J
Chrysene	UG/KG	86 J
Dibenz(a,h)anthracene	UG/KG	380 U
Indeno(1,2,3-cd)pyrene	UG/KG	40 J
BTE Concentration (ug/kg)		398.82

Site Wide Surface Soil Average	
BTE Concentration (mg/kg)	1.37

Table A-7B
Benzo(a)pyrene Toxicity Equivalency for SEAD-59 Subsurface Soil (2-15 ft)
SEAD-59 and SEAD-71 Phase II RI Report
Seneca Army Depot Activity

Facility	SEAD-59	SEAD-59	SEAD-59	SEAD-59	SEAD-59	SEAD-59	SEAD-59	SEAD-59	
Location ID	MW59-4	SB59-11	SB59-13	SB59-15	SB59-17	SB59-17	TP59-13A-1	TP59-13C-1	
Matrix	SOIL	SOIL	SOIL	SOIL	SOIL	SOIL	SOIL	SOIL	
Sample ID	59055	59132	59060	59061	59131	59068	59010	59015	
Sample Date	10/20/1997	10/24/1997	10/21/1997	10/21/1997	10/23/1997	10/23/1997	10/8/1997	10/8/1997	
Parameter	Units	Value (Q)	Value (Q)	Value (Q)	Value (Q)	Value (Q)	Value (Q)	Value (Q)	
Benzo(a)anthracene	UG/KG	78 U	3.8 J	140 U	77 U	23 J	71 J	8000 U	8.2 J
Benzo(a)pyrene	UG/KG	78 U	3.6 J	140 U	77 U	18 J	54 J	8000 U	10 J
Benzo(b)fluoranthene	UG/KG	78 U	3.8 J	140 U	7.6 J	20 J	56 J	8000 U	11 J
Benzo(k)fluoranthene	UG/KG	78 U	3.7 J	140 U	77 U	20 J	66 J	8000 U	10 J
Chrysene	UG/KG	78 U	4.8 J	140 U	4.8 J	22 J	72 J	8000 U	12 J
Dibenz(a,h)anthracene	UG/KG	78 U	70 U	140 U	77 U	4.8 J	13 J	8000 U	76 U
Indeno(1,2,3-cd)pyrene	UG/KG	78 U	70 U	140 U	77 U	10 J	33 J	8000 U	7.5 J
BTE Concentration (ug/kg)		90.48	42.945	162.4	85.893	28.52	84.38	9280	50.89

Facility	SEAD-59	SEAD-59	SEAD-59	SEAD-59	SEAD-59	SEAD-59	SEAD-59	
Location ID	TP59-16-1	TP59-6-2	SB59-1	SB59-2	SB59-5	TP59-2	TP59-5	
Matrix	SOIL	SOIL	SOIL	SOIL	SOIL	SOIL	SOIL	
Sample ID	59036	59002	SB59-1-06	SB59-2-04	SB59-5-06	TP59-2	TP59-5	
Sample Date	10/10/1997	10/7/1997	2/20/1994	5/26/1994	5/25/1994	2/20/1994	6/8/1994	
Parameter	Units	Value (Q)	Value (Q)	Value (Q)	Value (Q)	Value (Q)	Value (Q)	
Benzo(a)anthracene	UG/KG	210	280	1200	260 J	380 U	4200	390 U
Benzo(a)pyrene	UG/KG	220	260	1100	250 J	380 U	4600 J	390 U
Benzo(b)fluoranthene	UG/KG	250	220 J	860	290 J	380 U	4400 J	390 U
Benzo(k)fluoranthene	UG/KG	180	260	810	270 J	380 U	4900 J	390 U
Chrysene	UG/KG	240	310	1200	270 J	380 U	4400	390 U
Dibenz(a,h)anthracene	UG/KG	74 J	74 J	530 U	84 J	380 U	1800 UJ	390 U
Indeno(1,2,3-cd)pyrene	UG/KG	160	180	590	130 J	380 U	1500 J	390 U
BTE Concentration (ug/kg)		360.2	407.7	1650.1	407.4	440.8	6603	452.4

Site Wide Subsurface Soil BTE Average Concentration (mg/kg)	1.44
--	-------------

Table A-8
Benzo(a)pyrene Toxicity Equivalency for SEAD-59 Stockpile Soil
SEAD-59 and SEAD-71 Phase II RI Report
Seneca Army Depot Activity

Facility	SEAD-59	SEAD-59	SEAD-59	SEAD-59	SEAD-59	SEAD-59	SEAD-59	SEAD-59
Location ID	FD-59-WS-03	WS-59-01-005-4	WS-59-01-005-5	WS-59-01-006-1	WS-59-01-006-12	WS-59-01-006-3	WS-59-01-006-7	
Matrix	SOIL	SOIL	SOIL	SOIL	SOIL	SOIL	SOIL	
Sample ID	FD-59-WS-03	WS-59-01-005-4	WS-59-01-005-5	WS-59-01-006-1	WS-59-01-006-12	WS-59-01-006-3	WS-59-01-006-7	
Sample Date	5/6/2004	5/6/2004	5/6/2004	5/6/2004	5/6/2004	5/6/2004	5/6/2004	
Parameter	Units	Value (Q)	Value (Q)	Value (Q)	Value (Q)	Value (Q)	Value (Q)	Value (Q)
Benzo(a)anthracene	UG/KG	2000	1700	440	5500	5300	5300	4300
Benzo(a)pyrene	UG/KG	2400 J	1800	500	6000	6400 J	6900	5400
Benzo(b)fluoranthene	UG/KG	1600 J	1200	400	4000	4300	4600	3900
Benzo(k)fluoranthene	UG/KG	1600 J	1300	380 J	4300	4100	4300	3700
Chrysene	UG/KG	2000	1700	460	5300	5100	5400	4400
Dibenz(a,h)anthracene	UG/KG	560 J	310 J	120 J	1400 J	1500 J	1600 J	1400 J
Indeno(1,2,3-cd)pyrene	UG/KG	1600 J	860	350 J	3600 J	4000 J	4500 J	3600 J
BTE Concentration (ug/kg)		3516	2516	747.4	8806	9352	10037	8061

Facility	SEAD-59	SEAD-59	SEAD-59	SEAD-59	SEAD-59	SEAD-59	SEAD-59	SEAD-59
Location ID	WS-59-01-015-17	WS-59-01-015-20	WS-59-01-015-3	WS-59-01-015-4	WS-59-01-015-8	WS-59-01-016-1	WS-59-01-016-10	
Matrix	SOIL	SOIL	SOIL	SOIL	SOIL	SOIL	SOIL	
Sample ID	WS-59-01-015-17	WS-59-01-015-20	WS-59-01-015-3	WS-59-01-015-4	WS-59-01-015-8	WS-59-01-016-1	WS-59-01-016-10	
Sample Date	5/6/2004	5/6/2004	5/6/2004	5/6/2004	5/6/2004	5/6/2004	5/6/2004	
Parameter	Units	Value (Q)	Value (Q)	Value (Q)	Value (Q)	Value (Q)	Value (Q)	Value (Q)
Benzo(a)anthracene	UG/KG	5400	5600	460	4200	3700	8200	3800
Benzo(a)pyrene	UG/KG	5400	5900	550	6200	4200	7600	3600
Benzo(b)fluoranthene	UG/KG	3600	4500	410	4700	3200	6400	2500
Benzo(k)fluoranthene	UG/KG	4300	4900	420	4700	3400	6700	2800
Chrysene	UG/KG	5300	5400	480	4300 NJ	3600 NJ	9000	3700
Dibenz(a,h)anthracene	UG/KG	890 J	1000 J	120 J	1300 J	840 J	1200 J	730 J
Indeno(1,2,3-cd)pyrene	UG/KG	2600 J	2700 J	360 J	3800 J	2400 J	3400 J	2000 J
BTE Concentration (ug/kg)		7546	8283	802	8860	6040	10757	5225

Site Wide Stockpile Average	8.07
BTE Concentration (mg/kg)	

Table A-8
Benzo(a)pyrene Toxicity Equivalency for SEAD-59 Stockpile Soil
SEAD-59 and SEAD-71 Phase II RI Report
Seneca Army Depot Activity

Facility	SEAD-59	SEAD-59	SEAD-59	SEAD-59	SEAD-59	SEAD-59	SEAD-59	SEAD-59
Location ID	WS-59-01-006-9	WS-59-01-007-1	WS-59-01-007-10	WS-59-01-007-11	WS-59-01-007-12	WS-59-01-007-13	WS-59-01-007-14	WS-59-01-007-14
Matrix	SOIL	SOIL	SOIL	SOIL	SOIL	SOIL	SOIL	SOIL
Sample ID	WS-59-01-006-9	WS-59-01-007-1	WS-59-01-007-10	WS-59-01-007-11	WS-59-01-007-12	WS-59-01-007-13	WS-59-01-007-14	WS-59-01-007-14
Sample Date	5/6/2004	5/6/2004	5/6/2004	5/6/2004	5/6/2004	5/6/2004	5/6/2004	5/6/2004
Parameter	Units	Value (Q)	Value (Q)	Value (Q)	Value (Q)	Value (Q)	Value (Q)	Value (Q)
Benzo(a)anthracene	UG/KG	5600	5200	2200	3000	5400	3800	13000
Benzo(a)pyrene	UG/KG	7400	5400	2700	3100	5900	4300	14000
Benzo(b)fluoranthene	UG/KG	5400	3600	2000	2300	4300	2900	9800
Benzo(k)fluoranthene	UG/KG	5400	3600	2000	2400	4500	3200	11000
Chrysene	UG/KG	5700	5000	2300	3200	5400	3800	13000
Dibenz(a,h)anthracene	UG/KG	1500 J	1100 J	550 J	550 J	1100 J	780 J	2500 J
Indeno(1,2,3-cd)pyrene	UG/KG	4700 J	3000 J	1600 J	1600 J	2800 J	2000 J	7000 J
BTE Concentration (ug/kg)		10581	7766	3873	4396	8349	6020	19720

Facility	SEAD-59	SEAD-59	SEAD-59	SEAD-59	SEAD-59	SEAD-59	SEAD-59	SEAD-59
Location ID	WS-59-01-016-13	WS-59-01-016-14	WS-59-01-016-18	WS-59-01-016-19	WS-59-01-016-2	WS-59-01-016-20	WS-59-01-016-3	WS-59-01-016-3
Matrix	SOIL	SOIL	SOIL	SOIL	SOIL	SOIL	SOIL	SOIL
Sample ID	WS-59-01-016-13	WS-59-01-016-14	WS-59-01-016-18	WS-59-01-016-19	WS-59-01-016-2	WS-59-01-016-20	WS-59-01-016-3	WS-59-01-016-3
Sample Date	5/6/2004	5/6/2004	5/6/2004	5/6/2004	5/6/2004	5/6/2004	5/6/2004	5/6/2004
Parameter	Units	Value (Q)	Value (Q)	Value (Q)	Value (Q)	Value (Q)	Value (Q)	Value (Q)
Benzo(a)anthracene	UG/KG	3600	8400	860 J	1100 J	3800	6800	2700
Benzo(a)pyrene	UG/KG	3700	7300	950 J	1200 J	4600	8500	2900
Benzo(b)fluoranthene	UG/KG	2800	5300	750 J	1000 J	3400	6400	2300
Benzo(k)fluoranthene	UG/KG	3100	5800	790 J	910 J	3800	6500	2500
Chrysene	UG/KG	3500	7900	940 J	1200 J	3900	7500	2700
Dibenz(a,h)anthracene	UG/KG	660 J	1300 J	210 J	250 J	760 J	1800 J	510 J
Indeno(1,2,3-cd)pyrene	UG/KG	2100 J	3700 J	560 J	740 J	2100 J	5000 J	1400 J
BTE Concentration (ug/kg)		5276	10477	1394.3	1755.1	6367	12260	4102

Site Wide Stockpile Average	8.07
BTE Concentration (mg/kg)	

Table A-8
Benzo(a)pyrene Toxicity Equivalency for SEAD-59 Stockpile Soil
SEAD-59 and SEAD-71 Phase II RI Report
Seneca Army Depot Activity

Facility	SEAD-59	SEAD-59	SEAD-59	SEAD-59	SEAD-59	
Location ID	WS-59-01-007-2	WS-59-01-007-5	WS-59-01-007-6	WS-59-01-007-8	WS-59-01-008-1	
Matrix	SOIL	SOIL	SOIL	SOIL	SOIL	
Sample ID	WS-59-01-007-2	WS-59-01-007-5	WS-59-01-007-6	WS-59-01-007-8	WS-59-01-008-1	
Sample Date	5/6/2004	5/6/2004	5/6/2004	5/6/2004	5/6/2004	
Parameter	Units	Value (Q)	Value (Q)	Value (Q)	Value (Q)	
Benzo(a)anthracene	UG/KG	4300	3600	3400	6900	5400
Benzo(a)pyrene	UG/KG	4600	4400	3600	8200	5800
Benzo(b)fluoranthene	UG/KG	3300	3200	2800	5800	3900
Benzo(k)fluoranthene	UG/KG	3400	3400	2700	6300	3900
Chrysene	UG/KG	4200	3600	3300	7000	5400 J
Dibenz(a,h)anthracene	UG/KG	870 J	940 J	740 J	1600 J	1200 J
Indeno(1,2,3-cd)pyrene	UG/KG	2500 J	2600 J	2000 J	4100 J	3100 J
BTE Concentration (ug/kg)		6556	6350	5220	11613	8333

Facility	SEAD-59	SEAD-59	SEAD-59	SEAD-59	SEAD-59	
Location ID	WS-59-01-016-4	WS-59-01-016-5	WS-59-01-016-6	WS-59-01-016-9	WS-59-04-010-8	
Matrix	SOIL	SOIL	SOIL	SOIL	SOIL	
Sample ID	WS-59-01-016-4	WS-59-01-016-5	WS-59-01-016-6	WS-59-01-016-9	WS-59-04-010-8	
Sample Date	5/6/2004	5/6/2004	5/6/2004	5/6/2004	5/6/2004	
Parameter	Units	Value (Q)	Value (Q)	Value (Q)	Value (Q)	
Benzo(a)anthracene	UG/KG	900 J	4400	5000	7700	86 NJ
Benzo(a)pyrene	UG/KG	1000 J	4400	4700	6700	85 J
Benzo(b)fluoranthene	UG/KG	850 J	3300	3100	4900	110 J
Benzo(k)fluoranthene	UG/KG	930 J	3700	3700	5500	48 J
Chrysene	UG/KG	970 J	4300	4900	7600	87 J
Dibenz(a,h)anthracene	UG/KG	180 J	700 J	960 J	1400 J	370 U
Indeno(1,2,3-cd)pyrene	UG/KG	530 J	2000 J	2700 J	3800 J	55 J
BTE Concentration (ug/kg)		1427	6150	6826	9871	296.45

Site Wide Stockpile Average	8.07
BTE Concentration (mg/kg)	

Table A-9A
Benzo(a)pyrene Toxicity Equivalency for SEAD-71 Surface Soil (0-2 ft)
SEAD-59 and SEAD-71 Phase II RI Report
Seneca Army Depot Activity

Facility	SEAD-71	SEAD-71	SEAD-71	SEAD-71	SEAD-71	SEAD-71	SEAD-71	
Location ID	CL-71-A-F01	CL-71-A-WE1	CL-71-A-WN1	CL-71-A-WS1	CL-71-A-WW1	CL-71-B-F01	CL-71-B-WE2	
Matrix	SOIL	SOIL	SOIL	SOIL	SOIL	SOIL	SOIL	
Sample ID	CL-71-A-F01	CL-71-A-WE1	CL-71-A-WN1	CL-71-A-WS1	CL-71-A-WW1	CL-71-B-F01	CL-71-B-WE2	
Sample Date	5/6/2004	5/6/2004	5/6/2004	5/6/2004	5/6/2004	5/6/2004	5/6/2004	
Parameter	Units	Value (Q)	Value (Q)	Value (Q)	Value (Q)	Value (Q)	Value (Q)	
Benzo(a)anthracene	UG/KG	55 J	350 U	360 U	61 J	41 J	50 J	1300 J
Benzo(a)pyrene	UG/KG	58 J	350 U	360 U	52 J	37 J	45 J	1400 J
Benzo(b)fluoranthene	UG/KG	85 J	350 U	360 U	69 NJ	55 NJ	64 NJ	1600 J
Benzo(k)fluoranthene	UG/KG	400 U	350 U	360 U	370 U	350 U	350 U	1200 J
Chrysene	UG/KG	67 J	350 U	360 U	67 J	52 J	58 J	1800 J
Dibenz(a,h)anthracene	UG/KG	400 U	350 U	360 U	370 U	350 U	350 U	200 J
Indeno(1,2,3-cd)pyrene	UG/KG	400 U	350 U	360 U	370 U	350 U	350 U	730 J

BTE Concentration (ug/kg) **294.67** **406** **417.6** **271.02** **241.37** **251.23** **1993**

Facility	SEAD-71	SEAD-71	SEAD-71	SEAD-71	SEAD-71	SEAD-71	SEAD-71	
Location ID	CL-71-E3-WN1	CL-71-E3-WS1	CL-71-E3-WW1	SS71-1	SS71-10	SS71-11	SS71-12	
Matrix	SOIL	SOIL	SOIL	SOIL	SOIL	SOIL	SOIL	
Sample ID	CL-71-E3-WN1	CL-71-E3-WS1	CL-71-E3-WW1	71013	71017	71024	71023	
Sample Date	5/6/2004	5/6/2004	5/6/2004	11/19/1997	11/19/1997	11/20/1997	11/20/1997	
Parameter	Units	Value (Q)	Value (Q)	Value (Q)	Value (Q)	Value (Q)	Value (Q)	
Benzo(a)anthracene	UG/KG	380 U	400 U	240 J	500	220	150000	38000
Benzo(a)pyrene	UG/KG	380 U	400 U	250 J	550	220	120000	34000
Benzo(b)fluoranthene	UG/KG	380 U	400 U	300 J	750	280	88000	21000 J
Benzo(k)fluoranthene	UG/KG	380 U	400 U	290 J	750	250	130000	39000
Chrysene	UG/KG	380 U	43 J	370 J	930	290	150000	37000
Dibenz(a,h)anthracene	UG/KG	380 U	400 U	1200 U	130 J	51 J	25000 J	8200 J
Indeno(1,2,3-cd)pyrene	UG/KG	380 U	400 U	190 J	360	140	65000 J	19000 J

BTE Concentration (ug/kg) **440.8** **462.43** **929.6** **857.8** **340.4** **178100** **50760**

Site Wide Surface Soil Average BTE Concentration (mg/kg) 11.64
--

Site Wide Surface Soil Average w/ Fenced Area samples excluded BTE Concentration (mg/kg) 1.65

Note:
1) Bold Sample ID are samples from within the Fenced Area

Table A-9A
Benzo(a)pyrene Toxicity Equivalency for SEAD-71 Surface Soil (0-2 ft)
SEAD-59 and SEAD-71 Phase II RI Report
Seneca Army Depot Activity

Facility	SEAD-71	SEAD-71	SEAD-71	SEAD-71	SEAD-71	SEAD-71	SEAD-71	SEAD-71	SEAD-71
Location ID	CL-71-B-WN1	CL-71-B-WS1	CL-71-B-WW1	CL-71-B-WW2	CL-71-C-F01	CL-71-C-F02	CL-71-C-WE1	CL-71-C-WE2	
Matrix	SOIL	SOIL	SOIL	SOIL	SOIL	SOIL	SOIL	SOIL	
Sample ID	CL-71-B-WN1	CL-71-B-WS1	CL-71-B-WW1	CL-71-B-WW2	CL-71-C-F01	CL-71-C-F02	CL-71-C-WE1	CL-71-C-WE2	
Sample Date	5/6/2004	5/6/2004	5/6/2004	5/6/2004	5/6/2004	5/6/2004	5/6/2004	5/6/2004	
Parameter	Units	Value (Q)	Value (Q)	Value (Q)	Value (Q)	Value (Q)	Value (Q)	Value (Q)	Value (Q)
Benzo(a)anthracene	UG/KG	3100	470	360 U	390 U	1000	310 J	360 U	360 U
Benzo(a)pyrene	UG/KG	2900	400	38 J	390 U	800	500	360 U	360 U
Benzo(b)fluoranthene	UG/KG	3600	690	54 NJ	390 U	570	520	40 J	360 U
Benzo(k)fluoranthene	UG/KG	2100	270 J	360 U	390 U	670	460	360 U	360 U
Chrysene	UG/KG	3000	620	47 J	390 U	880	510	45 J	360 U
Dibenz(a,h)anthracene	UG/KG	330 J	61 J	360 U	390 U	170 J	140 J	360 U	360 U
Indeno(1,2,3-cd)pyrene	UG/KG	1200	190 J	360 U	390 U	420 J	450 J	360 U	360 U
BTE Concentration (ug/kg)		4071	604.9	261.67	452.4	1184.5	777.7	402.25	417.6

Facility	SEAD-71	SEAD-71	SEAD-71	SEAD-71	SEAD-71	SEAD-71	SEAD-71	SEAD-71	SEAD-71
Location ID	SS71-13	SS71-14	SS71-15	SS71-16	SS71-17	SS71-18	SS71-19	SS71-2	
Matrix	SOIL	SOIL	SOIL	SOIL	SOIL	SOIL	SOIL	SOIL	
Sample ID	71027	71025	71032	71021	71030	71022	71020	71014	
Sample Date	11/21/1997	11/20/1997	11/21/1997	11/20/1997	11/21/1997	11/20/1997	11/20/1997	11/19/1997	
Parameter	Units	Value (Q)	Value (Q)	Value (Q)	Value (Q)	Value (Q)	Value (Q)	Value (Q)	Value (Q)
Benzo(a)anthracene	UG/KG	100000	360	18000	91000	120000	2200	4500	1100
Benzo(a)pyrene	UG/KG	80000	350	16000	70000	96000	2100	4400	1300
Benzo(b)fluoranthene	UG/KG	63000 J	830	14000	59000	78000	4000	4600	1200
Benzo(k)fluoranthene	UG/KG	76000	89 U	19000	74000	93000	900 U	4700	1600
Chrysene	UG/KG	90000	560	20000	82000	110000	2800	5500	1600
Dibenz(a,h)anthracene	UG/KG	17000 J	83 J	3600 J	16000 J	21000 J	440 J	1100 J	300 J
Indeno(1,2,3-cd)pyrene	UG/KG	38000 J	190	11000	36000 J	45000	1200	2500 J	780 J
BTE Concentration (ug/kg)		118760	577.045	24290	106160	143330	3312.5	6762	1940

Site Wide Surface Soil Average
BTE Concentration (mg/kg) 11.64

Site Wide Surface Soil Average
w/ Fenced Area samples excluded
BTE Concentration (mg/kg) 1.65

Note:
1) Bold Sample ID are samples from within the Fenced Area

Table A-9A
Benzo(a)pyrene Toxicity Equivalency for SEAD-71 Surface Soil (0-2 ft)
SEAD-59 and SEAD-71 Phase II RI Report
Seneca Army Depot Activity

Facility	SEAD-71	SEAD-71	SEAD-71	SEAD-71	SEAD-71	SEAD-71	SEAD-71	SEAD-71	
Location ID	CL-71-C-WN1	CL-71-C-WS1	CL-71-C-WW2	CL-71-D-F01	CL-71-D-WE1	CL-71-D-WN1	CL-71-D-WS1	CL-71-D-WW3	
Matrix	SOIL	SOIL	SOIL	SOIL	SOIL	SOIL	SOIL	SOIL	
Sample ID	CL-71-C-WN1	CL-71-C-WS1	CL-71-C-WW2	CL-71-D-F01	CL-71-D-WE1	CL-71-D-WN1	CL-71-D-WS1	CL-71-D-WW3	
Sample Date	5/6/2004	5/6/2004	5/6/2004	5/6/2004	5/6/2004	5/6/2004	5/6/2004	5/6/2004	
Parameter	Units	Value (Q)	Value (Q)	Value (Q)	Value (Q)	Value (Q)	Value (Q)	Value (Q)	
Benzo(a)anthracene	UG/KG	4700	10000	130 J	410	500	1300	40 J	1600 J
Benzo(a)pyrene	UG/KG	6500	9000	170 J	410	450	1100	51 J	1500 J
Benzo(b)fluoranthene	UG/KG	5900	6700	140 J	540	640	1500	83 J	1300 J
Benzo(k)fluoranthene	UG/KG	5500	7700	140 J	200 J	230 J	560	360 U	1300 J
Chrysene	UG/KG	6300	10000	150 J	410 NJ	490	1300	49 J	2000 J
Dibenz(a,h)anthracene	UG/KG	1700 J	1900 J	44 J	67 J	75 J	160 J	360 U	5500 U
Indeno(1,2,3-cd)pyrene	UG/KG	4900 J	5200 J	110 J	260 J	300 J	630	39 J	970 J

BTE Concentration (ug/kg) **9868** **13267** **254.9** **604.1** **676.2** **1621.6** **249.49** **4670**

EXCEED

Facility	SEAD-71	SEAD-71	SEAD-71	SEAD-71	SEAD-71	SEAD-71	SEAD-71	SEAD-71	
Location ID	SS71-20	SS71-3	SS71-4	SS71-5	SS71-6	SS71-8	SS71-9	TP71-2	
Matrix	SOIL	SOIL	SOIL	SOIL	SOIL	SOIL	SOIL	SOIL	
Sample ID	71031	71015	71016	71029	71028	71019	71018	TP71-2-1	
Sample Date	11/21/1997	11/19/1997	11/19/1997	11/21/1997	11/21/1997	11/19/1997	11/19/1997	6/7/1994	
Parameter	Units	Value (Q)	Value (Q)	Value (Q)	Value (Q)	Value (Q)	Value (Q)	Value (Q)	
Benzo(a)anthracene	UG/KG	2100	570	70 J	3200	42000	880	310	370 J
Benzo(a)pyrene	UG/KG	2000	540	83	3400	47000	1100	360	490 J
Benzo(b)fluoranthene	UG/KG	1900	950	130	4300	56000	1400	810	750 J
Benzo(k)fluoranthene	UG/KG	2000	170 U	80 U	4500	47000	1400	89 U	490 J
Chrysene	UG/KG	2400	660	80	6200	64000	1600	500	610 J
Dibenz(a,h)anthracene	UG/KG	430 J	120 J	29 J	760 J	12000 J	340 J	93	170 J
Indeno(1,2,3-cd)pyrene	UG/KG	1100	310	57 J	2100	28000	780	200	430 J

BTE Concentration (ug/kg) **2984** **850.45** **138.9** **5227** **72710** **1776** **590.445** **826**

Site Wide Surface Soil Average
BTE Concentration (mg/kg) **11.64**

Site Wide Surface Soil Average
w/ Fenced Area samples excluded
BTE Concentration (mg/kg) **1.65**

Note:
1) Bold Sample ID are samples from within the Fenced Area

Table A-9A
Benzo(a)pyrene Toxicity Equivalency for SEAD-71 Surface Soil (0-2 ft)
SEAD-59 and SEAD-71 Phase II RI Report
Seneca Army Depot Activity

Facility	SEAD-71	SEAD-71	SEAD-71	SEAD-71	SEAD-71	SEAD-71	SEAD-71	SEAD-71	SEAD-71
Location ID	CL-71-E1-F01	CL-71-E1-WE1	CL-71-E1-WN1	CL-71-E1-WS1	CL-71-E1-WW1	CL-71-E2-F01	CL-71-E2-WE1	CL-71-E2-WN1	CL-71-E2-WN1
Matrix	SOIL	SOIL	SOIL	SOIL	SOIL	SOIL	SOIL	SOIL	SOIL
Sample ID	CL-71-E1-F01	CL-71-E1-WE1	CL-71-E1-WN1	CL-71-E1-WS1	CL-71-E1-WW1	CL-71-E2-F01	CL-71-E2-WE1	CL-71-E2-WN1	CL-71-E2-WN1
Sample Date	5/6/2004	5/6/2004	5/6/2004	5/6/2004	5/6/2004	5/6/2004	5/6/2004	5/6/2004	5/6/2004
Parameter	Units	Value (Q)	Value (Q)	Value (Q)	Value (Q)	Value (Q)	Value (Q)	Value (Q)	Value (Q)
Benzo(a)anthracene	UG/KG	360 U	360 U	300 J	130 J	140 J	330 J	9000	400 U
Benzo(a)pyrene	UG/KG	360 U	360 U	390	150 J	180 J	250 J	8800	400 U
Benzo(b)fluoranthene	UG/KG	360 U	360 U	720	310 J	400	380 J	7400	400 U
Benzo(k)fluoranthene	UG/KG	360 U	360 U	370	170 J	190 J	170 J	8000	400 U
Chrysene	UG/KG	360 U	360 U	490	240 J	280 J	360 J	10000	400 U
Dibenz(a,h)anthracene	UG/KG	360 U	360 U	65 J	360 U	340 U	390 U	2000 J	400 U
Indeno(1,2,3-cd)pyrene	UG/KG	360 U	360 U	250 J	100 J	130 J	110 J	5400 J	400 U
BTE Concentration (ug/kg)		417.6	417.6	590.6	388.1	421.7	532.3	13160	464

Facility	SEAD-71	SEAD-71	SEAD-71	SEAD-71	SEAD-71	SEAD-71	SEAD-71	SEAD-71	SEAD-71
Location ID	TP71-2	TP71-2	TP71-2	TP71-3-1	WS-71-A-009-9	WS-71-B-009-6	WS-71-B-009-8	WS-71-B-009-8	WS-71-D-009-13
Matrix	SOIL	SOIL	SOIL	SOIL	SOIL	SOIL	SOIL	SOIL	SOIL
Sample ID	TP71-2-2	TP71-2-4	TP71-2-3	71002	WS-71-A-009-9	WS-71-B-009-6	WS-71-B-009-8	WS-71-B-009-8	WS-71-D-009-13
Sample Date	6/7/1994	6/7/1994	6/7/1994	10/14/1997	5/6/2004	5/6/2004	5/6/2004	5/6/2004	5/6/2004
Parameter	Units	Value (Q)	Value (Q)	Value (Q)	Value (Q)	Value (Q)	Value (Q)	Value (Q)	Value (Q)
Benzo(a)anthracene	UG/KG	250 J	120 J	420 U	32 J	180 J	730	1500	830 J
Benzo(a)pyrene	UG/KG	290 J	94 J	420 U	66 U	170 J	810	1400	610 J
Benzo(b)fluoranthene	UG/KG	400	110 J	420 U	66 U	230 J	1100	1900	650 J
Benzo(k)fluoranthene	UG/KG	240 J	77 J	420 U	66 U	94 J	440	670	650 J
Chrysene	UG/KG	360 J	130 J	420 U	49 J	190 J	820	1500	1000 J
Dibenz(a,h)anthracene	UG/KG	130 J	380 U	420 U	66 U	370 U	42 J	230 J	170 J
Indeno(1,2,3-cd)pyrene	UG/KG	220 J	52 J	420 U	66 U	110 J	530	860	420 J
BTE Concentration (ug/kg)		513	314.27	487.2	76.62	409.84	1100.6	2077.7	986.5

EXCEED

Site Wide Surface Soil Average
BTE Concentration (mg/kg) 11.64

Site Wide Surface Soil Average
w/ Fenced Area samples excluded
BTE Concentration (mg/kg) 1.65

Note:
1) Bold Sample ID are samples from within the Fenced Area

Table A-9A
Benzo(a)pyrene Toxicity Equivalency for SEAD-71 Surface Soil (0-2 ft)
SEAD-59 and SEAD-71 Phase II RI Report
Seneca Army Depot Activity

	Facility	SEAD-71	SEAD-71	SEAD-71	SEAD-71
	Location ID	CL-71-E2-WS1	CL-71-E2-WW1	CL-71-E3-F01	CL-71-E3-WE1
	Matrix	SOIL	SOIL	SOIL	SOIL
	Sample ID	CL-71-E2-WS1	CL-71-E2-WW1	CL-71-E3-F01	CL-71-E3-WE1
	Sample Date	5/6/2004	5/6/2004	5/6/2004	5/6/2004
Parameter	Units	Value (Q)	Value (Q)	Value (Q)	Value (Q)
Benzo(a)anthracene	UG/KG	9100	390 U	390 U	370 U
Benzo(a)pyrene	UG/KG	6100	390 U	390 U	370 U
Benzo(b)fluoranthene	UG/KG	5000	390 U	390 U	370 U
Benzo(k)fluoranthene	UG/KG	5500	390 U	390 U	370 U
Chrysene	UG/KG	8800 J	390 U	390 U	370 U
Dibenz(a,h)anthracene	UG/KG	1400 J	390 U	390 U	370 U
Indeno(1,2,3-cd)pyrene	UG/KG	3300 J	390 U	390 U	370 U
BTE Concentration (ug/kg)		9383	452.4	452.4	429.2

	Facility	SEAD-71	SEAD-71	SEAD-71
	Location ID	WS-71-D-009-2	WS-71-E1-009-3	WS-71-E3-009-10
	Matrix	SOIL	SOIL	SOIL
	Sample ID	WS-71-D-009-2	WS-71-E1-009-3	WS-71-E3-009-10
	Sample Date	5/6/2004	5/6/2004	5/6/2004
Parameter	Units	Value (Q)	Value (Q)	Value (Q)
Benzo(a)anthracene	UG/KG	1300	390	1900 U
Benzo(a)pyrene	UG/KG	1500	330 J	1900 U
Benzo(b)fluoranthene	UG/KG	1400	390	1900 U
Benzo(k)fluoranthene	UG/KG	1300	370 J	1900 U
Chrysene	UG/KG	1600	510	1900 U
Dibenz(a,h)anthracene	UG/KG	310 J	86 J	1900 U
Indeno(1,2,3-cd)pyrene	UG/KG	880 J	250 J	1900 U
BTE Concentration (ug/kg)		2197	527.8	2204

Site Wide Surface Soil Average
BTE Concentration (mg/kg) 11.64

Site Wide Surface Soil Average
w/ Fenced Area samples excluded
BTE Concentration (mg/kg) 1.65

Note:
1) Bold Sample ID are samples from within the Fenced Area

Table A-9B
Benzo(a)pyrene Toxicity Equivalency for SEAD-71 Subsurface Soil (2-15 ft)
SEAD-59 and SEAD-71 Phase II RI Report
Seneca Army Depot Activity

Facility	SEAD-71	SEAD-71	SEAD-71	SEAD-71	SEAD-71	SEAD-71	SEAD-71	SEAD-71	
Location ID	TP71-1	TP71-1	TP71-1	TP71-1	TP71-3-2	TP71-4-2	TP71-5-1	TP71-6-1	
Matrix	SOIL	SOIL	SOIL	SOIL	SOIL	SOIL	SOIL	SOIL	
Sample ID	TP71-1-1	TP71-1-2	TP71-1-3	TP71-1-4	71003	71006	71007	71010	
Sample Date	6/7/1994	6/7/1994	6/7/1994	6/7/1994	10/14/1997	10/14/1997	10/14/1997	10/15/1997	
Parameter	Units	Value (Q)	Value (Q)	Value (Q)	Value (Q)	Value (Q)	Value (Q)	Value (Q)	
Benzo(a)anthracene	UG/KG	37000	1200	660	180 J	240 J	78 U	18 J	3.9 J
Benzo(a)pyrene	UG/KG	22000	750	630	160 J	160 J	78 U	19 J	3.9 J
Benzo(b)fluoranthene	UG/KG	26000	930	710	130 J	130 J	78 U	21 J	4.4 J
Benzo(k)fluoranthene	UG/KG	15000 J	570	490	140 J	98 J	78 U	24 J	4.6 J
Chrysene	UG/KG	36000	1000	750	220 J	290 J	78 U	28 J	4.6 J
Dibenz(a,h)anthracene	UG/KG	9800 J	190 J	320 J	38 J	760 U	78 U	4.4 J	78 U
Indeno(1,2,3-cd)pyrene	UG/KG	12000 J	390 J	520	88 J	56 J	78 U	12 J	78 U
BTE Concentration (ug/kg)		39810	1207.7	1151.4	241.4	586.48	90.48	29.02	47.722
Site Wide Subsurface Soil Average									
BTE Concentration (mg/kg)		5.40							

Table A-10A
SEAD-59 TCLP SOIL SAMPLE RESULTS
SEAD-59 and SEAD-71 Phase II RI Report
Seneca Army Depot Activity

	Facility		SEAD-59	SEAD-59	SEAD-59	SEAD-59	SEAD-59	SEAD-59	SEAD-59
	Location ID		FD-59-MC-01	FD-59-WS-01	FD-59-WS-02	FD-59-WS-07	MC-59-01-01	MC-59-01-02	MC-59-01-02-2
	Maxtrix		SOIL	SOIL	SOIL	SOIL	SOIL	SOIL	SOIL
	QC Code		SA	SA	SA	SA	SA	SA	SA
	Study ID		ENSR IRM	ENSR IRM	ENSR IRM	ENSR IRM	ENSR IRM	ENSR IRM	ENSR IRM
Parameter	Units	Chem Class	Value (Q)	Value (Q)	Value (Q)	Value (Q)	Value (Q)	Value (Q)	Value (Q)
1,1-Dichloroethene	UG/KG	VOA		5.7 U		5.8 U			
1,2-Dichloroethane	UG/KG	VOA		5.7 U		5.8 U			
Benzene	UG/KG	VOA		5.7 U		5.8 U			
Carbon tetrachloride	UG/KG	VOA		5.7 U		5.8 U			
Chlorobenzene	UG/KG	VOA		5.7 U		5.8 U			
Chloroform	UG/KG	VOA		5.7 U		5.8 U			
Methyl ethyl ketone	UG/KG	VOA		11 U		12 U			
Tetrachloroethene	UG/KG	VOA		5.7 U		5.8 U			
Trichloroethene	UG/KG	VOA		5.7 U		5.8 U			
Vinyl chloride	UG/KG	VOA		11 U		12 U			
2,4,5-Trichlorophenol	UG/KG	SV		380 U		3900 U			
2,4,6-Trichlorophenol	UG/KG	SV		380 U		3900 U			
2,4-Dinitrotoluene	UG/KG	SV		380 U		3900 U			
2-Methylphenol	UG/KG	SV		380 U		3900 U			
Hexachlorobenzene	UG/KG	SV		380 U		3900 U			
Hexachlorobutadiene	UG/KG	SV		380 U		3900 U			
Hexachloroethane	UG/KG	SV		380 U		3900 U			
Nitrobenzene	UG/KG	SV		380 U		3900 U			
Pentachlorophenol	UG/KG	SV		1900 U		20000 U			
Pyridine	UG/KG	SV		1900 U		20000 U			
Endrin	UG/KG	OC PEST		19 U		19 U			
Gamma-BHC/Lindane	UG/KG	OC PEST		9.7 U		10 U			
Heptachlor	UG/KG	OC PEST		9.7 U		10 U			
Heptachlor epoxide	UG/KG	OC PEST		9.7 U		10 U			
Methoxychlor	UG/KG	OC PEST		97 U		99 U			
Toxaphene	UG/KG	OC PEST		190 U		190 U			
Arsenic	MG/KG	M		4.5		4.4 J			
Barium	MG/KG	M		94		97.8			
Cadmium	MG/KG	M		0.28 U		0.36 J			
Chromium	MG/KG	M		16.3		17.8 J			
Lead	MG/KG	M		15.9 J		41.3 J			
Mercury	MG/KG	M		0.06		0.05			
Selenium	MG/KG	M		0.56 U		1.2 UJ			
Silver	MG/KG	M		0.56 U		0.57 U			
TCLP 1,1-Dichloroethene	UG/L	TCLP VOA	50 U				50 U	50 U	
TCLP 1,2-Dichloroethane	UG/L	TCLP VOA	50 U				50 U	50 U	
TCLP Benzene	UG/L	TCLP VOA	50 U				14 J	50 U	
TCLP Carbon tetrachloride	UG/L	TCLP VOA	50 U				50 U	50 U	
TCLP Chlorobenzene	UG/L	TCLP VOA	50 U				50 U	50 U	
TCLP Chloroform	UG/L	TCLP VOA	50 U				50 U	50 U	
TCLP Methyl ethyl ketone	UG/L	TCLP VOA	100 U				100 U	100 U	
TCLP Tetrachloroethene	UG/L	TCLP VOA	50 U				50 U	50 U	
TCLP Trichloroethene	UG/L	TCLP VOA	50 U				50 U	50 U	
TCLP Vinyl chloride	UG/L	TCLP VOA	50 U				50 U	50 U	
TCLP 2,4,5-Trichlorophenol	UG/L	TCLP SV	100 U		100 U	100 U	100 U		100 U
TCLP 2,4,6-Trichlorophenol	UG/L	TCLP SV	100 U		100 U	100 U	100 U		100 U

Table A-10A
SEAD-59 TCLP SOIL SAMPLE RESULTS
SEAD-59 and SEAD-71 Phase II RI Report
Seneca Army Depot Activity

	Facility		SEAD-59	SEAD-59	SEAD-59	SEAD-59	SEAD-59	SEAD-59	SEAD-59
	Location ID		FD-59-MC-01	FD-59-WS-01	FD-59-WS-02	FD-59-WS-07	MC-59-01-01	MC-59-01-02	MC-59-01-02-2
	Maxtrix		SOIL	SOIL	SOIL	SOIL	SOIL	SOIL	SOIL
	QC Code		SA	SA	SA	SA	SA	SA	SA
	Study ID		ENSR IRM	ENSR IRM	ENSR IRM	ENSR IRM	ENSR IRM	ENSR IRM	ENSR IRM
Parameter	Units	Chem Class	Value (Q)	Value (Q)	Value (Q)	Value (Q)	Value (Q)	Value (Q)	Value (Q)
TCLP 2,4-Dinitrotoluene	UG/L	TCLP SV	100 U		100 U	100 U	100 U	100 U	100 U
TCLP 2-Methylphenol	UG/L	TCLP SV	100 U		100 U	100 U	100 U	100 U	100 U
TCLP Hexachlorobenzene	UG/L	TCLP SV	100 U		100 U	100 U	100 U	100 U	100 U
TCLP Hexachlorobutadiene	UG/L	TCLP SV	100 U		100 U	100 U	100 U	100 U	100 U
TCLP Hexachloroethane	UG/L	TCLP SV	100 U		100 U	100 U	100 U	100 U	100 U
TCLP Nitrobenzene	UG/L	TCLP SV	100 U		100 U	100 U	100 U	100 U	100 U
TCLP Pentachlorophenol	UG/L	TCLP SV	500 U		500 U	500 U	500 U	500 U	500 U
TCLP Pyridine	UG/L	TCLP SV	500 U		500 U	500 U	500 U	500 U	500 U
TCLP Endrin	UG/L	TCLP OCP	10 U				10 U		10 U
TCLP Gamma-BHC/Lindane	UG/L	TCLP OCP	5 U				5 U		5 U
TCLP Heptachlor	UG/L	TCLP OCP	5 U				5 U		5 U
TCLP Heptachlor epoxide	UG/L	TCLP OCP	5 U				5 U		5 U
TCLP Methoxychlor	UG/L	TCLP OCP	50 U				50 U		50 U
TCLP Technical chlordane	UG/L	TCLP OCP	20 U				20 U		20 U
TCLP Toxaphene	UG/L	TCLP OCP	100 U				100 U		100 U
TCLP Arsenic	UG/L	TCLP M	500 U	500 U	500 U		500 U		500 U
TCLP Barium	UG/L	TCLP M	1000 U	2000 UN	2000 U		1000 U		1000 U
TCLP Cadmium	UG/L	TCLP M	100 U	100 U	100 U		100 U		100 U
TCLP Chromium	UG/L	TCLP M	100 U	100 U	100 U		100 U		100 U
TCLP Lead	UG/L	TCLP M	100 U	100 U	100 U		100 U		100 U
TCLP Mercury	UG/L	TCLP M	2 U	2 U	2 U		2 U		3 U
TCLP Selenium	UG/L	TCLP M	500 U	500 U	500 U		500 U		500 U
TCLP Silver	UG/L	TCLP M	100 U	100 U	100 U		100 U		100 U

Note(s):

(1) - All samples were collected during the 2002 TCRA; the samples present have not been validated.

U = compound was not detected

J = the reported value is an estimated concentration

UJ = the compound was not detected; the associated reporting limit is approximate

R = the data was rejected in the data validating process

NJ = compound was "tentatively identified" and the associated numerical value is approximate

**Table A-10A
SEAD-59 TCLP SOIL SAMPLE RESULTS
SEAD-59 and SEAD-71 Phase II RI Report
Seneca Army Depot Activity**

Facility	SEAD-59	SEAD-59	SEAD-59	SEAD-59	SEAD-59	SEAD-59	SEAD-59	SEAD-59	SEAD-59
Location ID	MC-59-03-01	MC-59-03-02	WS-59-01-003-6	WS-59-01-003-7	WS-59-01-004-2	WS-59-01-004-3	WS-59-01-004-4	WS-59-01-004-5	WS-59-01-004-5
Maxtrix	SOIL	SOIL	SOIL	SOIL	SOIL	SOIL	SOIL	SOIL	SOIL
QC Code	SA	SA	SA	SA	SA	SA	SA	SA	SA
Study ID	ENSR IRM	ENSR IRM	ENSR IRM	ENSR IRM	ENSR IRM	ENSR IRM	ENSR IRM	ENSR IRM	ENSR IRM

Parameter	Units	Chem Class	Value (Q)	Value (Q)	Value (Q)	Value (Q)	Value (Q)	Value (Q)	Value (Q)	Value (Q)
1,1-Dichloroethene	UG/KG	VOA								
1,2-Dichloroethane	UG/KG	VOA								
Benzene	UG/KG	VOA								
Carbon tetrachloride	UG/KG	VOA								
Chlorobenzene	UG/KG	VOA								
Chloroform	UG/KG	VOA								
Methyl ethyl ketone	UG/KG	VOA								
Tetrachloroethene	UG/KG	VOA								
Trichloroethene	UG/KG	VOA								
Vinyl chloride	UG/KG	VOA								
2,4,5-Trichlorophenol	UG/KG	SV								
2,4,6-Trichlorophenol	UG/KG	SV								
2,4-Dinitrotoluene	UG/KG	SV								
2-Methylphenol	UG/KG	SV								
Hexachlorobenzene	UG/KG	SV								
Hexachlorobutadiene	UG/KG	SV								
Hexachloroethane	UG/KG	SV								
Nitrobenzene	UG/KG	SV								
Pentachlorophenol	UG/KG	SV								
Pyridine	UG/KG	SV								
Endrin	UG/KG	OC PEST								
Gamma-BHC/Lindane	UG/KG	OC PEST								
Heptachlor	UG/KG	OC PEST								
Heptachlor epoxide	UG/KG	OC PEST								
Methoxychlor	UG/KG	OC PEST								
Toxaphene	UG/KG	OC PEST								
Arsenic	MG/KG	M								
Barium	MG/KG	M								
Cadmium	MG/KG	M								
Chromium	MG/KG	M								
Lead	MG/KG	M								
Mercury	MG/KG	M								
Selenium	MG/KG	M								
Silver	MG/KG	M								
TCLP 1,1-Dichloroethene	UG/L	TCLP VOA	50 U	50 U						
TCLP 1,2-Dichloroethane	UG/L	TCLP VOA	50 U	50 U						
TCLP Benzene	UG/L	TCLP VOA	50 U	50 U						
TCLP Carbon tetrachloride	UG/L	TCLP VOA	50 U	50 U						
TCLP Chlorobenzene	UG/L	TCLP VOA	50 U	50 U						
TCLP Chloroform	UG/L	TCLP VOA	50 U	50 U						
TCLP Methyl ethyl ketone	UG/L	TCLP VOA	100 U	100 U						
TCLP Tetrachloroethene	UG/L	TCLP VOA	50 U	50 U						
TCLP Trichloroethene	UG/L	TCLP VOA	50 U	50 U						
TCLP Vinyl chloride	UG/L	TCLP VOA	50 U	50 U						
TCLP 2,4,5-Trichlorophenol	UG/L	TCLP SV	100 U	100 U	100 U	100 U	100 U	100 U	100 U	100 U
TCLP 2,4,6-Trichlorophenol	UG/L	TCLP SV	100 U	100 U	100 U	100 U	100 U	100 U	100 U	100 U

Table A-10A
SEAD-59 TCLP SOIL SAMPLE RESULTS
SEAD-59 and SEAD-71 Phase II RI Report
Seneca Army Depot Activity

Facility	SEAD-59	SEAD-59	SEAD-59	SEAD-59	SEAD-59	SEAD-59	SEAD-59	SEAD-59	SEAD-59
Location ID	MC-59-03-01	MC-59-03-02	WS-59-01-003-6	WS-59-01-003-7	WS-59-01-004-2	WS-59-01-004-3	WS-59-01-004-4	WS-59-01-004-5	
Maxtrix	SOIL	SOIL	SOIL	SOIL	SOIL	SOIL	SOIL	SOIL	SOIL
QC Code	SA	SA	SA	SA	SA	SA	SA	SA	SA
Study ID	ENSR IRM	ENSR IRM	ENSR IRM	ENSR IRM	ENSR IRM	ENSR IRM	ENSR IRM	ENSR IRM	ENSR IRM

Parameter	Units	Chem Class	Value (Q)	Value (Q)	Value (Q)	Value (Q)	Value (Q)	Value (Q)	Value (Q)	Value (Q)
TCLP 2,4-Dinitrotoluene	UG/L	TCLP SV	100 U	100 U	100 U	100 U	100 U	100 U	100 U	100 U
TCLP 2-Methylphenol	UG/L	TCLP SV	100 U	100 U	100 U	100 U	100 U	100 U	100 U	100 U
TCLP Hexachlorobenzene	UG/L	TCLP SV	100 U	100 U	100 U	100 U	100 U	100 U	100 U	100 U
TCLP Hexachlorobutadiene	UG/L	TCLP SV	100 U	100 U	100 U	100 U	100 U	100 U	100 U	100 U
TCLP Hexachloroethane	UG/L	TCLP SV	100 U	100 U	100 U	100 U	100 U	100 U	100 U	100 U
TCLP Nitrobenzene	UG/L	TCLP SV	100 U	100 U	100 U	100 U	100 U	100 U	100 U	100 U
TCLP Pentachlorophenol	UG/L	TCLP SV	500 U	500 U	500 U	500 U	500 U	500 U	500 U	500 U
TCLP Pyridine	UG/L	TCLP SV	500 U	500 U	500 U	500 U	500 U	500 U	500 U	500 U
TCLP Endrin	UG/L	TCLP OCP	10 U	10 U						
TCLP Gamma-BHC/Lindane	UG/L	TCLP OCP	5 U	5 U						
TCLP Heptachlor	UG/L	TCLP OCP	5 U	5 U						
TCLP Heptachlor epoxide	UG/L	TCLP OCP	5 U	5 U						
TCLP Methoxychlor	UG/L	TCLP OCP	50 U	50 U						
TCLP Technical chlordane	UG/L	TCLP OCP	20 U	20 U						
TCLP Toxaphene	UG/L	TCLP OCP	100 U	100 U						
TCLP Arsenic	UG/L	TCLP M	500 U	500 U		500 U				
TCLP Barium	UG/L	TCLP M	1000 U	1000 U		2000 U				
TCLP Cadmium	UG/L	TCLP M	100 U	100 U		100 U				
TCLP Chromium	UG/L	TCLP M	100 U	100 U		100 U				
TCLP Lead	UG/L	TCLP M	224	100 U		100 U				
TCLP Mercury	UG/L	TCLP M	2 U	2 U		2 U				
TCLP Selenium	UG/L	TCLP M	500 U	500 U		500 U				
TCLP Silver	UG/L	TCLP M	100 U	100 U		100 U				

Note(s):
(1) - All samples were collected during the 2002 TCRA; the samples pres

U = compound was not detected
J = the reported value is an estimated concentration
UJ = the compound was not detected; the associated reporting limit is app
R = the data was rejected in the data validating process
NJ = compound was "tentatively identified" and the associated numerical

Table A-10A
SEAD-59 TCLP SOIL SAMPLE RESULTS
SEAD-59 and SEAD-71 Phase II RI Report
Seneca Army Depot Activity

	Facility	SEAD-59	SEAD-59	SEAD-59	SEAD-59	SEAD-59	SEAD-59	SEAD-59
	Location ID	WS-59-01-004-6	WS-59-01-005-1	WS-59-01-005-2	WS-59-01-005-3	WS-59-01-005-4	WS-59-01-006-10	WS-59-01-006-8
	Maxtrix	SOIL	SOIL	SOIL	SOIL	SOIL	SOIL	SOIL
	QC Code	SA	SA	SA	SA	SA	SA	SA
	Study ID	ENSR IRM	ENSR IRM	ENSR IRM	ENSR IRM	ENSR IRM	ENSR IRM	ENSR IRM
Parameter	Units	Chem Class	Value (Q)	Value (Q)	Value (Q)	Value (Q)	Value (Q)	Value (Q)
1,1-Dichloroethene	UG/KG	VOA				5.7 U	5.8 U	5.7 U
1,2-Dichloroethane	UG/KG	VOA				5.7 U	5.8 U	5.7 U
Benzene	UG/KG	VOA				5.7 U	5.8 U	5.7 U
Carbon tetrachloride	UG/KG	VOA				5.7 U	5.8 U	5.7 U
Chlorobenzene	UG/KG	VOA				5.7 U	5.8 U	5.7 U
Chloroform	UG/KG	VOA				5.7 U	5.8 U	5.7 U
Methyl ethyl ketone	UG/KG	VOA				11 U	12 U	11 U
Tetrachloroethene	UG/KG	VOA				5.7 U	5.8 U	5.7 U
Trichloroethene	UG/KG	VOA				5.7 U	5.8 U	5.7 U
Vinyl chloride	UG/KG	VOA				11 U	12 U	11 U
2,4,5-Trichlorophenol	UG/KG	SV				760 U	7600 U	1900 U
2,4,6-Trichlorophenol	UG/KG	SV				760 U	7600 U	1900 U
2,4-Dinitrotoluene	UG/KG	SV				760 U	7600 U	1900 U
2-Methylphenol	UG/KG	SV				760 U	7600 U	1900 U
Hexachlorobenzene	UG/KG	SV				760 U	7600 U	1900 U
Hexachlorobutadiene	UG/KG	SV				760 U	7600 U	1900 U
Hexachloroethane	UG/KG	SV				760 U	7600 U	1900 U
Nitrobenzene	UG/KG	SV				760 U	7600 U	1900 U
Pentachlorophenol	UG/KG	SV				3900 U	39000 U	9600 U
Pyridine	UG/KG	SV				3900 U	39000 U	9600 U
Endrin	UG/KG	OC PEST				19 U	19 U	75 U
Gamma-BHC/Lindane	UG/KG	OC PEST				9.7 U	9.8 U	39 U
Heptachlor	UG/KG	OC PEST				9.7 U	9.8 U	39 U
Heptachlor epoxide	UG/KG	OC PEST				9.7 U	9.8 U	39 U
Methoxychlor	UG/KG	OC PEST				97 U	98 U	390 U
Toxaphene	UG/KG	OC PEST				190 U	190 U	750 U
Arsenic	MG/KG	M				4.1	5 J	5.3 J
Barium	MG/KG	M				88.1	90.2	85.4
Cadmium	MG/KG	M				0.28 U	0.66	0.7
Chromium	MG/KG	M				19	18.9	18.1
Lead	MG/KG	M				55.3 J	48.8	164
Mercury	MG/KG	M				0.08	0.07	0.05
Selenium	MG/KG	M				0.57 U	0.57 U	0.56 U
Silver	MG/KG	M				0.57 U	0.57 UJ	0.56 UJ
TCLP 1,1-Dichloroethene	UG/L	TCLP VOA						
TCLP 1,2-Dichloroethane	UG/L	TCLP VOA						
TCLP Benzene	UG/L	TCLP VOA						
TCLP Carbon tetrachloride	UG/L	TCLP VOA						
TCLP Chlorobenzene	UG/L	TCLP VOA						
TCLP Chloroform	UG/L	TCLP VOA						
TCLP Methyl ethyl ketone	UG/L	TCLP VOA						
TCLP Tetrachloroethene	UG/L	TCLP VOA						
TCLP Trichloroethene	UG/L	TCLP VOA						
TCLP Vinyl chloride	UG/L	TCLP VOA						
TCLP 2,4,5-Trichlorophenol	UG/L	TCLP SV	100 U	100 U	100 U	100 U	100 U	100 U
TCLP 2,4,6-Trichlorophenol	UG/L	TCLP SV	100 U	100 U	100 U	100 U	100 U	100 U

Table A-10A
SEAD-59 TCLP SOIL SAMPLE RESULTS
SEAD-59 and SEAD-71 Phase II RI Report
Seneca Army Depot Activity

	Facility		SEAD-59	SEAD-59	SEAD-59	SEAD-59	SEAD-59	SEAD-59	SEAD-59
	Location ID		WS-59-01-004-6	WS-59-01-005-1	WS-59-01-005-2	WS-59-01-005-3	WS-59-01-005-4	WS-59-01-006-10	WS-59-01-006-8
	Maxtrix		SOIL	SOIL	SOIL	SOIL	SOIL	SOIL	SOIL
	QC Code		SA	SA	SA	SA	SA	SA	SA
	Study ID		ENSR IRM	ENSR IRM	ENSR IRM	ENSR IRM	ENSR IRM	ENSR IRM	ENSR IRM
Parameter	Units	Chem Class	Value (Q)	Value (Q)	Value (Q)	Value (Q)	Value (Q)	Value (Q)	Value (Q)
TCLP 2,4-Dinitrotoluene	UG/L	TCLP SV	100 U	100 U	100 U	100 U	100 U	100 U	100 U
TCLP 2-Methylphenol	UG/L	TCLP SV	100 U	100 U	100 U	100 U	100 U	100 U	100 U
TCLP Hexachlorobenzene	UG/L	TCLP SV	100 U	100 U	100 U	100 U	100 U	100 U	100 U
TCLP Hexachlorobutadiene	UG/L	TCLP SV	100 U	100 U	100 U	100 U	100 U	100 U	100 U
TCLP Hexachloroethane	UG/L	TCLP SV	100 U	100 U	100 U	100 U	100 U	100 U	100 U
TCLP Nitrobenzene	UG/L	TCLP SV	100 U	100 U	100 U	100 U	100 U	100 U	100 U
TCLP Pentachlorophenol	UG/L	TCLP SV	500 U	500 U	500 U	500 U	500 U	500 U	500 U
TCLP Pyridine	UG/L	TCLP SV	500 U	500 U	500 U	500 U	500 U	500 U	500 U
TCLP Endrin	UG/L	TCLP OCP							
TCLP Gamma-BHC/Lindane	UG/L	TCLP OCP							
TCLP Heptachlor	UG/L	TCLP OCP							
TCLP Heptachlor epoxide	UG/L	TCLP OCP							
TCLP Methoxychlor	UG/L	TCLP OCP							
TCLP Technical chlordanes	UG/L	TCLP OCP							
TCLP Toxaphene	UG/L	TCLP OCP							
TCLP Arsenic	UG/L	TCLP M	500 U						500 U
TCLP Barium	UG/L	TCLP M	2000 U						1040
TCLP Cadmium	UG/L	TCLP M	100 U						100 U
TCLP Chromium	UG/L	TCLP M	100 U						100 U
TCLP Lead	UG/L	TCLP M	100 U						100 U
TCLP Mercury	UG/L	TCLP M	2 U						2 U
TCLP Selenium	UG/L	TCLP M	500 U						500 U
TCLP Silver	UG/L	TCLP M	100 U						100 U

Note(s):

(1) - All samples were collected during the 2002 TCRA; the samples pres

U = compound was not detected

J = the reported value is an estimated concentration

UJ = the compound was not detected; the associated reporting limit is app

R = the data was rejected in the data validating process

NJ = compound was "tentatively identified" and the associated numerical

Table A-10A
SEAD-59 TCLP SOIL SAMPLE RESULTS
SEAD-59 and SEAD-71 Phase II RI Report
Seneca Army Depot Activity

Facility	SEAD-59	SEAD-59	SEAD-59	SEAD-59	SEAD-59	SEAD-59	SEAD-59	SEAD-59	
Location ID	WS-59-01-006-9	WS-59-01-007-14	WS-59-01-007-7	WS-59-01-007-8	WS-59-01-008-2	WS-59-01-011-7	WS-59-01-013-5		
Maxtrix	SOIL	SOIL	SOIL	SOIL	SOIL	SOIL	SOIL		
QC Code	SA	SA	SA	SA	SA	SA	SA		
Study ID	ENSR IRM	ENSR IRM	ENSR IRM	ENSR IRM	ENSR IRM	ENSR IRM	ENSR IRM		
Parameter	Units	Chem Class	Value (Q)	Value (Q)	Value (Q)	Value (Q)	Value (Q)	Value (Q)	
1,1-Dichloroethene	UG/KG	VOA	5.7 U	5.6 U	6 U	5.6 U	5.6 U	5.8 U	5.8 U
1,2-Dichloroethane	UG/KG	VOA	5.7 U	5.6 U	6 U	5.6 U	5.6 U	5.8 U	5.8 U
Benzene	UG/KG	VOA	5.7 U	5.6 U	6 U	5.6 U	5.6 U	5.8 U	5.8 U
Carbon tetrachloride	UG/KG	VOA	5.7 U	5.6 U	6 U	5.6 U	5.6 U	5.8 U	5.8 U
Chlorobenzene	UG/KG	VOA	5.7 UJ	5.6 U	6 U	5.6 U	5.6 U	5.8 U	5.8 U
Chloroform	UG/KG	VOA	5.7 U	5.6 U	6 U	5.6 U	5.6 U	5.8 U	5.8 U
Methyl ethyl ketone	UG/KG	VOA	11 U	11 U	12 U	11 U	11 U	12 U	12 U
Tetrachloroethene	UG/KG	VOA	5.7 UJ	5.6 U	6 U	5.6 U	5.6 U	5.8 U	5.8 U
Trichloroethene	UG/KG	VOA	1.7 J	5.6 U	6 U	1.4 J	5.6 U	5.8 U	5.8 U
Vinyl chloride	UG/KG	VOA	11 UJ	11 U	12 U	11 U	11 U	12 U	12 U
2,4,5-Trichlorophenol	UG/KG	SV	3800 U	3700 U	4000 U	3700 U	3700 U	3800 U	1900 U
2,4,6-Trichlorophenol	UG/KG	SV	3800 U	3700 U	4000 U	3700 U	3700 U	3800 U	1900 U
2,4-Dinitrotoluene	UG/KG	SV	3800 U	3700 U	4000 U	3700 U	3700 U	3800 U	1900 U
2-Methylphenol	UG/KG	SV	3800 U	3700 U	4000 U	3700 U	3700 U	3800 U	1900 U
Hexachlorobenzene	UG/KG	SV	3800 U	3700 U	4000 U	3700 U	3700 U	3800 U	1900 U
Hexachlorobutadiene	UG/KG	SV	3800 U	3700 U	4000 U	3700 U	3700 U	3800 U	1900 U
Hexachloroethane	UG/KG	SV	3800 U	3700 U	4000 U	3700 U	3700 U	3800 U	1900 U
Nitrobenzene	UG/KG	SV	3800 U	3700 U	4000 U	3700 U	3700 U	3800 U	1900 U
Pentachlorophenol	UG/KG	SV	1900 U	1900 U	2000 U	1900 U	1900 U	2000 U	9900 U
Pyridine	UG/KG	SV	1900 U	1900 U	2000 U	1900 U	1900 U	2000 U	9900 U
Endrin	UG/KG	OC PEST	19 U	18 U	20 U	19 U	18 U	19 U	19 U
Gamma-BHC/Lindane	UG/KG	OC PEST	9.7 U	9.5 U	10 U	9.6 U	9.5 U	9.9 U	10 U
Heptachlor	UG/KG	OC PEST	9.7 U	9.5 U	10 U	9.6 U	9.5 U	9.9 U	10 U
Heptachlor epoxide	UG/KG	OC PEST	9.7 U	9.5 U	10 U	9.6 U	9.5 U	9.9 U	10 U
Methoxychlor	UG/KG	OC PEST	97 U	95 U	100 U	96 U	95 U	99 U	99 U
Toxaphene	UG/KG	OC PEST	190 U	180 U	200 U	190 U	180 U	190 U	190 U
Arsenic	MG/KG	M	5.8 J	4.6	4.2	4.8	4.9	3.9 J	6
Barium	MG/KG	M	90.8	78.5	97	81.5	82.6	53.6	105
Cadmium	MG/KG	M	0.76	0.72	0.64	0.66	0.62	0.29 J	0.58
Chromium	MG/KG	M	21.3	19.6	20	17.6	20.5	15.3 J	23.4
Lead	MG/KG	M	51.8	32.7 J	38.2 J	37.4 J	34.8 J	40.9 J	84.6 J
Mercury	MG/KG	M	0.08	0.04	0.07	0.06	0.04	0.06	0.07
Selenium	MG/KG	M	0.57 U	0.69 J	0.57 U	0.54 U	0.54 U	1.2 UJ	0.78 J
Silver	MG/KG	M	0.57 UJ	0.55 UJ	0.57 UJ	0.54 UJ	0.54 U	0.55 U	0.57 U
TCLP 1,1-Dichloroethene	UG/L	TCLP VOA							
TCLP 1,2-Dichloroethane	UG/L	TCLP VOA							
TCLP Benzene	UG/L	TCLP VOA							
TCLP Carbon tetrachloride	UG/L	TCLP VOA							
TCLP Chlorobenzene	UG/L	TCLP VOA							
TCLP Chloroform	UG/L	TCLP VOA							
TCLP Methyl ethyl ketone	UG/L	TCLP VOA							
TCLP Tetrachloroethene	UG/L	TCLP VOA							
TCLP Trichloroethene	UG/L	TCLP VOA							
TCLP Vinyl chloride	UG/L	TCLP VOA							
TCLP 2,4,5-Trichlorophenol	UG/L	TCLP SV	100 U	100 U	100 U	100 U	100 U	100 U	100 U
TCLP 2,4,6-Trichlorophenol	UG/L	TCLP SV	100 U	100 U	100 U	100 U	100 U	100 U	100 U

Table A-10A
SEAD-59 TCLP SOIL SAMPLE RESULTS
SEAD-59 and SEAD-71 Phase II RI Report
Seneca Army Depot Activity

	Facility		SEAD-59	SEAD-59	SEAD-59	SEAD-59	SEAD-59	SEAD-59	SEAD-59
	Location ID		WS-59-01-006-9	WS-59-01-007-14	WS-59-01-007-7	WS-59-01-007-8	WS-59-01-008-2	WS-59-01-011-7	WS-59-01-013-5
	Maxtrix		SOIL	SOIL	SOIL	SOIL	SOIL	SOIL	SOIL
	QC Code		SA	SA	SA	SA	SA	SA	SA
	Study ID		ENSR IRM	ENSR IRM	ENSR IRM	ENSR IRM	ENSR IRM	ENSR IRM	ENSR IRM
Parameter	Units	Chem Class	Value (Q)	Value (Q)	Value (Q)	Value (Q)	Value (Q)	Value (Q)	Value (Q)
TCLP 2,4-Dinitrotoluene	UG/L	TCLP SV	100 U	100 U	100 U	100 U	100 U	100 U	
TCLP 2-Methylphenol	UG/L	TCLP SV	100 U	100 U	100 U	100 U	100 U	100 U	
TCLP Hexachlorobenzene	UG/L	TCLP SV	100 U	100 U	100 U	100 U	100 U	100 U	
TCLP Hexachlorobutadiene	UG/L	TCLP SV	100 U	100 U	100 U	100 U	100 U	100 U	
TCLP Hexachloroethane	UG/L	TCLP SV	100 U	100 U	100 U	100 U	100 U	100 U	
TCLP Nitrobenzene	UG/L	TCLP SV	100 U	100 U	100 U	100 U	100 U	100 U	
TCLP Pentachlorophenol	UG/L	TCLP SV	500 U	500 U	500 U	500 U	500 U	500 U	
TCLP Pyridine	UG/L	TCLP SV	500 U	500 U	500 U	500 U	500 U	500 U	
TCLP Endrin	UG/L	TCLP OCP							
TCLP Gamma-BHC/Lindane	UG/L	TCLP OCP							
TCLP Heptachlor	UG/L	TCLP OCP							
TCLP Heptachlor epoxide	UG/L	TCLP OCP							
TCLP Methoxychlor	UG/L	TCLP OCP							
TCLP Technical chlordanes	UG/L	TCLP OCP							
TCLP Toxaphene	UG/L	TCLP OCP							
TCLP Arsenic	UG/L	TCLP M							500 U
TCLP Barium	UG/L	TCLP M							1010
TCLP Cadmium	UG/L	TCLP M							100 U
TCLP Chromium	UG/L	TCLP M							100 U
TCLP Lead	UG/L	TCLP M							100 U
TCLP Mercury	UG/L	TCLP M							2 U
TCLP Selenium	UG/L	TCLP M							500 U
TCLP Silver	UG/L	TCLP M							100 U

Note(s):

(1) - All samples were collected during the 2002 TCRA; the samples pres

U = compound was not detected

J = the reported value is an estimated concentration

UJ = the compound was not detected; the associated reporting limit is app

R = the data was rejected in the data validating process

NJ = compound was "tentatively identified" and the associated numerical

Table A-10A
SEAD-59 TCLP SOIL SAMPLE RESULTS
SEAD-59 and SEAD-71 Phase II RI Report
Seneca Army Depot Activity

Facility	SEAD-59	SEAD-59	SEAD-59	SEAD-59	SEAD-59	SEAD-59	SEAD-59	SEAD-59	
Location ID	WS-59-01-015-12	WS-59-01-015-14	WS-59-01-015-16	WS-59-01-015-19	WS-59-01-016-10	WS-59-01-016-14	WS-59-01-016-18		
Maxtrix	SOIL	SOIL	SOIL	SOIL	SOIL	SOIL	SOIL		
QC Code	SA	SA	SA	SA	SA	SA	SA		
Study ID	ENSR IRM	ENSR IRM	ENSR IRM	ENSR IRM	ENSR IRM	ENSR IRM	ENSR IRM		
Parameter	Units	Chem Class	Value (Q)	Value (Q)	Value (Q)	Value (Q)	Value (Q)	Value (Q)	
1,1-Dichloroethene	UG/KG	VOA		6 U	5.7 U	5.8 U	5.8 U	5.8 U	5.9 U
1,2-Dichloroethane	UG/KG	VOA		6 U	5.7 U	5.8 U	5.8 U	5.8 U	5.9 U
Benzene	UG/KG	VOA		6 U	5.7 U	5.8 U	5.8 U	5.8 U	5.9 U
Carbon tetrachloride	UG/KG	VOA		6 U	5.7 U	5.8 U	5.8 U	5.8 U	5.9 U
Chlorobenzene	UG/KG	VOA		6 U	5.7 U	5.8 U	5.8 U	5.8 U	5.9 U
Chloroform	UG/KG	VOA		6 U	5.7 U	5.8 U	5.8 U	5.8 U	5.9 U
Methyl ethyl ketone	UG/KG	VOA		12 U	11 U	12 U	12 U	12 U	12 U
Tetrachloroethene	UG/KG	VOA		6 U	5.7 U	5.8 U	5.8 U	5.8 U	5.4 J
Trichloroethene	UG/KG	VOA		6 U	5.7 U	5.8 U	5.8 U	5.8 U	5.9 U
Vinyl chloride	UG/KG	VOA		12 U	11 U	12 U	12 U	12 U	12 U
2,4,5-Trichlorophenol	UG/KG	SV		2000 U	1900 U	1900 U	1900 U	1200 U	1900 U
2,4,6-Trichlorophenol	UG/KG	SV		2000 U	1900 U	1900 U	1900 U	1200 U	1900 U
2,4-Dinitrotoluene	UG/KG	SV		2000 U	1900 U	1900 U	1900 U	1200 U	1900 U
2-Methylphenol	UG/KG	SV		2000 U	1900 U	1900 U	1900 U	1200 U	1900 U
Hexachlorobenzene	UG/KG	SV		2000 U	1900 U	1900 U	1900 U	1200 U	1900 U
Hexachlorobutadiene	UG/KG	SV		2000 U	1900 U	1900 U	1900 U	1200 U	1900 U
Hexachloroethane	UG/KG	SV		2000 U	1900 U	1900 U	1900 U	1200 U	1900 U
Nitrobenzene	UG/KG	SV		2000 U	1900 U	1900 U	1900 U	1200 U	1900 U
Pentachlorophenol	UG/KG	SV		10000 U	9700 U	9800 U	9900 U	5900 U	10000 U
Pyridine	UG/KG	SV		10000 U	9700 U	9800 U	9900 U	5900 U	10000 U
Endrin	UG/KG	OC PEST		20 U	19 U	19 U	96 U	96 U	97 U
Gamma-BHC/Lindane	UG/KG	OC PEST		10 U	9.7 U	9.8 U	50 U	50 U	50 U
Heptachlor	UG/KG	OC PEST		10 U	9.7 U	9.8 U	50 U	50 U	50 U
Heptachlor epoxide	UG/KG	OC PEST		10 U	9.7 U	9.8 U	50 U	50 U	50 U
Methoxychlor	UG/KG	OC PEST		100 U	97 U	98 U	500 U	500 U	500 U
Toxaphene	UG/KG	OC PEST		200 U	190 U	190 U	960 U	960 U	970 U
Arsenic	MG/KG	M		4.5 J	4.5	4.7	4	4.6	4.6
Barium	MG/KG	M		135	91.6	96.5	93.1	78.9	85
Cadmium	MG/KG	M		0.89	0.55 J	0.48 J	0.72	0.78	0.97
Chromium	MG/KG	M		19.9 J	27.7	17.9	16.9	29.7	35
Lead	MG/KG	M		195 J	149 J	80.8 J	1440 J	84.6 J	129 J
Mercury	MG/KG	M		0.06	0.04	0.04	0.27	0.04	0.51
Selenium	MG/KG	M		1.2 UJ	0.55 U	0.54 U	0.56 U	0.58 U	0.58 U
Silver	MG/KG	M		0.57 U	0.55 U	0.54 U	0.56 U	0.58 U	4.7
TCLP 1,1-Dichloroethene	UG/L	TCLP VOA							
TCLP 1,2-Dichloroethane	UG/L	TCLP VOA							
TCLP Benzene	UG/L	TCLP VOA							
TCLP Carbon tetrachloride	UG/L	TCLP VOA							
TCLP Chlorobenzene	UG/L	TCLP VOA							
TCLP Chloroform	UG/L	TCLP VOA							
TCLP Methyl ethyl ketone	UG/L	TCLP VOA							
TCLP Tetrachloroethene	UG/L	TCLP VOA							
TCLP Trichloroethene	UG/L	TCLP VOA							
TCLP Vinyl chloride	UG/L	TCLP VOA							
TCLP 2,4,5-Trichlorophenol	UG/L	TCLP SV							
TCLP 2,4,6-Trichlorophenol	UG/L	TCLP SV							

Table A-10A
SEAD-59 TCLP SOIL SAMPLE RESULTS
SEAD-59 and SEAD-71 Phase II RI Report
Seneca Army Depot Activity

	Facility	SEAD-59	SEAD-59	SEAD-59	SEAD-59	SEAD-59	SEAD-59	SEAD-59	SEAD-59
	Location ID	WS-59-01-015-12	WS-59-01-015-14	WS-59-01-015-16	WS-59-01-015-19	WS-59-01-016-10	WS-59-01-016-14	WS-59-01-016-18	
	Maxtrix	SOIL	SOIL	SOIL	SOIL	SOIL	SOIL	SOIL	
	QC Code	SA	SA	SA	SA	SA	SA	SA	
	Study ID	ENSR IRM	ENSR IRM	ENSR IRM	ENSR IRM	ENSR IRM	ENSR IRM	ENSR IRM	
Parameter	Units	Chem Class	Value (Q)	Value (Q)	Value (Q)	Value (Q)	Value (Q)	Value (Q)	Value (Q)
TCLP 2,4-Dinitrotoluene	UG/L	TCLP SV							
TCLP 2-Methylphenol	UG/L	TCLP SV							
TCLP Hexachlorobenzene	UG/L	TCLP SV							
TCLP Hexachlorobutadiene	UG/L	TCLP SV							
TCLP Hexachloroethane	UG/L	TCLP SV							
TCLP Nitrobenzene	UG/L	TCLP SV							
TCLP Pentachlorophenol	UG/L	TCLP SV							
TCLP Pyridine	UG/L	TCLP SV							
TCLP Endrin	UG/L	TCLP OCP							
TCLP Gamma-BHC/Lindane	UG/L	TCLP OCP							
TCLP Heptachlor	UG/L	TCLP OCP							
TCLP Heptachlor epoxide	UG/L	TCLP OCP							
TCLP Methoxychlor	UG/L	TCLP OCP							
TCLP Technical chlordane	UG/L	TCLP OCP							
TCLP Toxaphene	UG/L	TCLP OCP							
TCLP Arsenic	UG/L	TCLP M	500 U	500 U	500 U	500 U	500 U	500 U	500 U
TCLP Barium	UG/L	TCLP M	1000 U	1000 U	1000 U	1000 U	1000 U	1000 U	1000 U
TCLP Cadmium	UG/L	TCLP M	100 U	100 U	100 U	100 U	100 U	100 U	100 U
TCLP Chromium	UG/L	TCLP M	100 U	100 U	100 U	100 U	100 U	100 U	100 U
TCLP Lead	UG/L	TCLP M	100 U	106	100 U	100 U	100 U	100 U	100 U
TCLP Mercury	UG/L	TCLP M	2 U	2 U	2 U	2 U	2 U	2 U	2 U
TCLP Selenium	UG/L	TCLP M	500 U	500 U	500 U	500 U	500 U	500 U	500 U
TCLP Silver	UG/L	TCLP M	100 U	100 U	100 U	100 U	100 U	100 U	100 U

Note(s):

(1) - All samples were collected during the 2002 TCRA; the samples pres

U = compound was not detected

J = the reported value is an estimated concentration

UJ = the compound was not detected; the associated reporting limit is app

R = the data was rejected in the data validating process

NJ = compound was "tentatively identified" and the associated numerical

Table A-10A
SEAD-59 TCLP SOIL SAMPLE RESULTS
SEAD-59 and SEAD-71 Phase II RI Report
Seneca Army Depot Activity

Facility	SEAD-59	SEAD-59	SEAD-59	SEAD-59	SEAD-59	SEAD-59	SEAD-59	SEAD-59
Location ID	WS-59-02-002-1	WS-59-02-002-2	WS-59-02-002-3	WS-59-02-003-1	WS-59-02-003-2	WS-59-02-003-3	WS-59-02-003-4	
Maxtrix	SOIL	SOIL	SOIL	SOIL	SOIL	SOIL	SOIL	
QC Code	SA	SA	SA	SA	SA	SA	SA	
Study ID	ENSR IRM	ENSR IRM	ENSR IRM	ENSR IRM	ENSR IRM	ENSR IRM	ENSR IRM	
Parameter	Units	Chem Class	Value (Q)	Value (Q)	Value (Q)	Value (Q)	Value (Q)	Value (Q)
1,1-Dichloroethene	UG/KG	VOA	5.6 U	5.7 U	5.6 U	5.7 U	5.7 U	5.7 U
1,2-Dichloroethane	UG/KG	VOA	5.6 U	5.7 U	5.6 U	5.7 U	5.7 U	5.7 U
Benzene	UG/KG	VOA	5.6 U	5.7 U	5.6 U	5.7 U	5.7 U	5.7 U
Carbon tetrachloride	UG/KG	VOA	5.6 U	5.7 U	5.6 U	5.7 U	5.7 U	5.7 U
Chlorobenzene	UG/KG	VOA	5.6 U	5.7 U	5.6 U	5.7 U	5.7 U	5.7 U
Chloroform	UG/KG	VOA	5.6 U	5.7 U	5.6 U	5.7 U	5.7 U	5.7 U
Methyl ethyl ketone	UG/KG	VOA	11 U	11 U	11 U	11 U	11 U	11 U
Tetrachloroethene	UG/KG	VOA	5.6 U	5.7 U	5.6 U	5.7 U	5.7 U	5.7 U
Trichloroethene	UG/KG	VOA	5.6 U	5.7 U	5.6 U	5.7 U	5.7 U	5.7 U
Vinyl chloride	UG/KG	VOA	11 U	11 U	11 U	11 U	11 U	11 U
2,4,5-Trichlorophenol	UG/KG	SV	370 U	370 U	370 U	380 U	380 U	380 U
2,4,6-Trichlorophenol	UG/KG	SV	370 U	370 U	370 U	380 U	380 U	380 U
2,4-Dinitrotoluene	UG/KG	SV	370 U	370 U	370 U	380 U	380 U	380 U
2-Methylphenol	UG/KG	SV	370 U	370 U	370 U	380 U	380 U	380 U
Hexachlorobenzene	UG/KG	SV	370 U	370 U	370 U	380 U	380 U	380 U
Hexachlorobutadiene	UG/KG	SV	370 U	370 U	370 U	380 U	380 U	380 U
Hexachloroethane	UG/KG	SV	370 U	370 U	370 U	380 U	380 U	380 U
Nitrobenzene	UG/KG	SV	370 U	370 U	370 U	380 U	380 U	380 U
Pentachlorophenol	UG/KG	SV	1900 U	1900 U	1900 U	1900 U	2000 U	1900 U
Pyridine	UG/KG	SV	1900 U	1900 U	1900 U	1900 U	2000 U	1900 U
Endrin	UG/KG	OC PEST	19 U	19 U	19 U	19 U	19 U	19 U
Gamma-BHC/Lindane	UG/KG	OC PEST	9.6 U	9.6 U	9.5 U	9.7 U	9.7 U	9.7 U
Heptachlor	UG/KG	OC PEST	9.6 U	9.6 U	9.5 U	9.7 U	9.7 U	9.7 U
Heptachlor epoxide	UG/KG	OC PEST	9.6 U	9.6 U	9.5 U	9.7 U	9.7 U	9.7 U
Methoxychlor	UG/KG	OC PEST	96 U	96 U	95 U	97 U	97 U	97 U
Toxaphene	UG/KG	OC PEST	190 U	190 U	190 U	190 U	190 U	190 U
Arsenic	MG/KG	M	5.5	4.6	4.6	5.3	5.5	4.9
Barium	MG/KG	M	94.5	84.2	76.2	63.3	98.6	99.5
Cadmium	MG/KG	M	0.27 U	0.28 U	0.27 U	0.27 U	0.28 U	0.28 U
Chromium	MG/KG	M	16	17.1	15.2	14.5	19	17.3
Lead	MG/KG	M	18.3 J	20.1 J	15 J	21.1 J	29.3 J	24.7 J
Mercury	MG/KG	M	0.06	0.06	0.05	0.09	0.1	0.07
Selenium	MG/KG	M	0.55 U	0.56 U	0.54 U	0.55 U	0.55 U	0.56 U
Silver	MG/KG	M	0.55 U	0.56 U	0.54 U	0.55 U	0.55 U	0.56 U
TCLP 1,1-Dichloroethene	UG/L	TCLP VOA						
TCLP 1,2-Dichloroethane	UG/L	TCLP VOA						
TCLP Benzene	UG/L	TCLP VOA						
TCLP Carbon tetrachloride	UG/L	TCLP VOA						
TCLP Chlorobenzene	UG/L	TCLP VOA						
TCLP Chloroform	UG/L	TCLP VOA						
TCLP Methyl ethyl ketone	UG/L	TCLP VOA						
TCLP Tetrachloroethene	UG/L	TCLP VOA						
TCLP Trichloroethene	UG/L	TCLP VOA						
TCLP Vinyl chloride	UG/L	TCLP VOA						
TCLP 2,4,5-Trichlorophenol	UG/L	TCLP SV						
TCLP 2,4,6-Trichlorophenol	UG/L	TCLP SV						

Table A-10A
SEAD-59 TCLP SOIL SAMPLE RESULTS
SEAD-59 and SEAD-71 Phase II RI Report
Seneca Army Depot Activity

	Facility	SEAD-59	SEAD-59	SEAD-59	SEAD-59	SEAD-59	SEAD-59	SEAD-59	SEAD-59
	Location ID	WS-59-02-002-1	WS-59-02-002-2	WS-59-02-002-3	WS-59-02-003-1	WS-59-02-003-2	WS-59-02-003-3	WS-59-02-003-4	
	Maxtrix	SOIL	SOIL	SOIL	SOIL	SOIL	SOIL	SOIL	SOIL
	QC Code	SA	SA	SA	SA	SA	SA	SA	SA
	Study ID	ENSR IRM	ENSR IRM	ENSR IRM	ENSR IRM	ENSR IRM	ENSR IRM	ENSR IRM	ENSR IRM
Parameter	Units	Chem Class	Value (Q)	Value (Q)	Value (Q)	Value (Q)	Value (Q)	Value (Q)	Value (Q)
TCLP 2,4-Dinitrotoluene	UG/L	TCLP SV							
TCLP 2-Methylphenol	UG/L	TCLP SV							
TCLP Hexachlorobenzene	UG/L	TCLP SV							
TCLP Hexachlorobutadiene	UG/L	TCLP SV							
TCLP Hexachloroethane	UG/L	TCLP SV							
TCLP Nitrobenzene	UG/L	TCLP SV							
TCLP Pentachlorophenol	UG/L	TCLP SV							
TCLP Pyridine	UG/L	TCLP SV							
TCLP Endrin	UG/L	TCLP OCP							
TCLP Gamma-BHC/Lindane	UG/L	TCLP OCP							
TCLP Heptachlor	UG/L	TCLP OCP							
TCLP Heptachlor epoxide	UG/L	TCLP OCP							
TCLP Methoxychlor	UG/L	TCLP OCP							
TCLP Technical chlordane	UG/L	TCLP OCP							
TCLP Toxaphene	UG/L	TCLP OCP							
TCLP Arsenic	UG/L	TCLP M	500 U	500 U	500 U	500 U	500 U	500 U	500 U
TCLP Barium	UG/L	TCLP M	2000 UN	2000 UN	2000 UN	2000 UN	2000 UN	2000 UN	2000 UN
TCLP Cadmium	UG/L	TCLP M	100 U	100 U	100 U	100 U	100 U	100 U	100 U
TCLP Chromium	UG/L	TCLP M	100 U	100 U	100 U	100 U	100 U	100 U	100 U
TCLP Lead	UG/L	TCLP M	100 U	100 U	100 U	100 U	100 U	100 U	100 U
TCLP Mercury	UG/L	TCLP M	2 U	2 U	2 U	2 U	2 U	2 U	2 U
TCLP Selenium	UG/L	TCLP M	500 UN	500 UN	500 UN	500 UN	500 UN	500 UN	500 UN
TCLP Silver	UG/L	TCLP M	100 U	100 U	100 U	100 U	100 U	100 U	100 U

Note(s):

(1) - All samples were collected during the 2002 TCRA; the samples pres

U = compound was not detected

J = the reported value is an estimated concentration

UJ = the compound was not detected; the associated reporting limit is app

R = the data was rejected in the data validating process

NJ = compound was "tentatively identified" and the associated numerical

Table A-10A
SEAD-59 TCLP SOIL SAMPLE RESULTS
SEAD-59 and SEAD-71 Phase II RI Report
Seneca Army Depot Activity

Facility	SEAD-59	SEAD-59	SEAD-59	SEAD-59	SEAD-59	SEAD-59	SEAD-59		
Location ID	WS-59-02-003-5	WS-59-02-004-1	WS-59-03-001-1	WS-59-03-001-2	WS-59-03-001-3	WS-59-03-002-1	WS-59-03-002-2		
Maxtrix	SOIL	SOIL	SOIL	SOIL	SOIL	SOIL	SOIL		
QC Code	SA	SA	SA	SA	SA	SA	SA		
Study ID	ENSR IRM	ENSR IRM	ENSR IRM	ENSR IRM	ENSR IRM	ENSR IRM	ENSR IRM		
Parameter	Units	Chem Class	Value (Q)	Value (Q)	Value (Q)	Value (Q)	Value (Q)	Value (Q)	Value (Q)
1,1-Dichloroethene	UG/KG	VOA	5.6 U	5.8 U	5.6 U	5.7 U	5.8 U	5.7 U	5.7 U
1,2-Dichloroethane	UG/KG	VOA	5.6 U	5.8 U	5.6 U	5.7 U	5.8 U	5.7 U	5.7 U
Benzene	UG/KG	VOA	5.6 U	5.8 U	5.6 U	5.7 U	5.8 U	5.7 U	5.7 U
Carbon tetrachloride	UG/KG	VOA	5.6 U	5.8 U	5.6 U	5.7 U	5.8 U	5.7 U	5.7 U
Chlorobenzene	UG/KG	VOA	5.6 U	5.8 U	5.6 U	5.7 U	5.8 U	5.7 U	5.7 U
Chloroform	UG/KG	VOA	5.6 U	5.8 U	5.6 U	5.7 U	5.8 U	5.7 U	5.7 U
Methyl ethyl ketone	UG/KG	VOA	11 U	12 U	11 U	11 U	12 U	11 U	11 U
Tetrachloroethene	UG/KG	VOA	5.6 U	5.8 U	5.6 U	5.7 U	5.8 U	5.7 U	5.7 U
Trichloroethene	UG/KG	VOA	5.6 U	5.8 U	5.6 U	5.7 U	5.8 U	5.7 U	5.7 U
Vinyl chloride	UG/KG	VOA	11 U	12 U	11 U	11 U	12 U	11 U	11 U
2,4,5-Trichlorophenol	UG/KG	SV	370 U	380 U	370 U	380 U	380 U	380 U	380 U
2,4,6-Trichlorophenol	UG/KG	SV	370 U	380 U	370 U	380 U	380 U	380 U	380 U
2,4-Dinitrotoluene	UG/KG	SV	370 U	380 U	370 UJ	380 U	380 U	380 U	380 U
2-Methylphenol	UG/KG	SV	370 U	380 U	370 U	380 U	380 U	380 U	380 U
Hexachlorobenzene	UG/KG	SV	370 U	380 U	370 UJ	380 U	380 U	380 U	380 U
Hexachlorobutadiene	UG/KG	SV	370 U	380 U	370 UJ	380 U	380 U	380 U	380 U
Hexachloroethane	UG/KG	SV	370 U	380 U	370 UJ	380 U	380 U	380 U	380 U
Nitrobenzene	UG/KG	SV	370 U	380 U	370 UJ	380 U	380 U	380 U	380 U
Pentachlorophenol	UG/KG	SV	1900 U	2000 U	1900 U	1900 U	2000 U	1900 U	1900 U
Pyridine	UG/KG	SV	1900 U	2000 U	1900 UJ	1900 U	2000 U	1900 U	1900 U
Endrin	UG/KG	OC PEST	19 U	19 U	19 U	19 U	19 U	19 U	19 U
Gamma-BHC/Lindane	UG/KG	OC PEST	9.5 U	9.9 U	9.6 U	9.7 U	9.9 U	9.7 U	9.7 U
Heptachlor	UG/KG	OC PEST	9.5 U	9.9 U	9.6 U	9.7 U	9.9 U	9.7 U	9.7 U
Heptachlor epoxide	UG/KG	OC PEST	9.5 U	9.9 U	9.6 U	9.7 U	9.9 U	9.7 U	9.7 U
Methoxychlor	UG/KG	OC PEST	95 U	99 U	96 U	97 U	99 U	97 U	97 U
Toxaphene	UG/KG	OC PEST	190 U	190 U	190 U	190 U	190 U	190 U	190 U
Arsenic	MG/KG	M	5.1	6.9	5.2	4.6	4.9	5.1	5.3
Barium	MG/KG	M	106	54	98.7	90.4	94.7	84	107
Cadmium	MG/KG	M	0.26 U	0.28 U	0.28 U	0.28 U	0.28 U	0.3 J	0.28 U
Chromium	MG/KG	M	17.7	14.1	17.8	16.6	17.6	18	18.1
Lead	MG/KG	M	26.6 J	11.7 J	21 J	20.5 J	19.5 J	20 J	24.4 J
Mercury	MG/KG	M	0.07	0.03 J	0.07	0.06	0.05	0.06	0.09
Selenium	MG/KG	M	0.53 U	0.55 U	0.56 U	0.55 U	0.57 U	0.57 U	0.56 U
Silver	MG/KG	M	0.53 U	0.55 U	0.56 U	0.55 U	0.57 U	0.57 U	0.56 U
TCLP 1,1-Dichloroethene	UG/L	TCLP VOA							
TCLP 1,2-Dichloroethane	UG/L	TCLP VOA							
TCLP Benzene	UG/L	TCLP VOA							
TCLP Carbon tetrachloride	UG/L	TCLP VOA							
TCLP Chlorobenzene	UG/L	TCLP VOA							
TCLP Chloroform	UG/L	TCLP VOA							
TCLP Methyl ethyl ketone	UG/L	TCLP VOA							
TCLP Tetrachloroethene	UG/L	TCLP VOA							
TCLP Trichloroethene	UG/L	TCLP VOA							
TCLP Vinyl chloride	UG/L	TCLP VOA							
TCLP 2,4,5-Trichlorophenol	UG/L	TCLP SV							
TCLP 2,4,6-Trichlorophenol	UG/L	TCLP SV							

Table A-10A
SEAD-59 TCLP SOIL SAMPLE RESULTS
SEAD-59 and SEAD-71 Phase II RI Report
Seneca Army Depot Activity

	Facility	SEAD-59	SEAD-59	SEAD-59	SEAD-59	SEAD-59	SEAD-59	SEAD-59	SEAD-59
	Location ID	WS-59-02-003-5	WS-59-02-004-1	WS-59-03-001-1	WS-59-03-001-2	WS-59-03-001-3	WS-59-03-002-1	WS-59-03-002-2	
	Maxtrix	SOIL	SOIL	SOIL	SOIL	SOIL	SOIL	SOIL	SOIL
	QC Code	SA	SA	SA	SA	SA	SA	SA	SA
	Study ID	ENSR IRM	ENSR IRM	ENSR IRM	ENSR IRM	ENSR IRM	ENSR IRM	ENSR IRM	ENSR IRM
Parameter	Units	Chem Class	Value (Q)	Value (Q)	Value (Q)	Value (Q)	Value (Q)	Value (Q)	Value (Q)
TCLP 2,4-Dinitrotoluene	UG/L	TCLP SV							
TCLP 2-Methylphenol	UG/L	TCLP SV							
TCLP Hexachlorobenzene	UG/L	TCLP SV							
TCLP Hexachlorobutadiene	UG/L	TCLP SV							
TCLP Hexachloroethane	UG/L	TCLP SV							
TCLP Nitrobenzene	UG/L	TCLP SV							
TCLP Pentachlorophenol	UG/L	TCLP SV							
TCLP Pyridine	UG/L	TCLP SV							
TCLP Endrin	UG/L	TCLP OCP							
TCLP Gamma-BHC/Lindane	UG/L	TCLP OCP							
TCLP Heptachlor	UG/L	TCLP OCP							
TCLP Heptachlor epoxide	UG/L	TCLP OCP							
TCLP Methoxychlor	UG/L	TCLP OCP							
TCLP Technical chlordane	UG/L	TCLP OCP							
TCLP Toxaphene	UG/L	TCLP OCP							
TCLP Arsenic	UG/L	TCLP M	500 U	500 U	500 U	500 U	500 U	500 U	500 U
TCLP Barium	UG/L	TCLP M	2000 UN	2000 UN	2000 UN	2000 UN	2000 UN	2000 UN	2000 UN
TCLP Cadmium	UG/L	TCLP M	100 U	100 U	100 U	100 U	100 U	100 U	100 U
TCLP Chromium	UG/L	TCLP M	100 U	100 U	100 U	100 U	100 U	100 U	100 U
TCLP Lead	UG/L	TCLP M	100 U	100 U	100 U	100 U	100 U	100 U	100 U
TCLP Mercury	UG/L	TCLP M	2 U	2 U	2 U	2 U	2 U	2 U	2 U
TCLP Selenium	UG/L	TCLP M	500 UN	500 UN	500 U	500 U	500 U	500 U	500 U
TCLP Silver	UG/L	TCLP M	100 U	100 U	100 U	100 U	100 U	100 U	100 U

Note(s):

(1) - All samples were collected during the 2002 TCRA; the samples pres

U = compound was not detected

J = the reported value is an estimated concentration

UJ = the compound was not detected; the associated reporting limit is app

R = the data was rejected in the data validating process

NJ = compound was "tentatively identified" and the associated numerical

Table A-10A
SEAD-59 TCLP SOIL SAMPLE RESULTS
SEAD-59 and SEAD-71 Phase II RI Report
Seneca Army Depot Activity

Facility	SEAD-59	SEAD-59	SEAD-59
Location ID	WS-59-03-002-3	WS-59-03-002-4	WS-59-OTHERC-001-1
Maxtrix	SOIL	SOIL	SOIL
QC Code	SA	SA	SA
Study ID	ENSR IRM	ENSR IRM	ENSR IRM

Parameter	Units	Chem Class	Value (Q)	Value (Q)	Value (Q)
1,1-Dichloroethene	UG/KG	VOA	5.7 U	5.7 U	5.7 U
1,2-Dichloroethane	UG/KG	VOA	5.7 U	5.7 U	5.7 U
Benzene	UG/KG	VOA	5.7 U	5.7 U	5.7 U
Carbon tetrachloride	UG/KG	VOA	5.7 U	5.7 U	5.7 U
Chlorobenzene	UG/KG	VOA	5.7 U	5.7 U	5.7 U
Chloroform	UG/KG	VOA	5.7 U	5.7 U	5.7 U
Methyl ethyl ketone	UG/KG	VOA	11 U	11 U	11 U
Tetrachloroethene	UG/KG	VOA	5.7 U	5.7 U	5.7 U
Trichloroethene	UG/KG	VOA	5.7 U	5.7 U	5.7 U
Vinyl chloride	UG/KG	VOA	11 U	11 U	11 U
2,4,5-Trichlorophenol	UG/KG	SV	380 U	380 U	380 U
2,4,6-Trichlorophenol	UG/KG	SV	380 U	380 U	380 U
2,4-Dinitrotoluene	UG/KG	SV	380 U	380 U	380 U
2-Methylphenol	UG/KG	SV	380 U	380 U	380 U
Hexachlorobenzene	UG/KG	SV	380 U	380 U	380 U
Hexachlorobutadiene	UG/KG	SV	380 U	380 U	380 U
Hexachloroethane	UG/KG	SV	380 U	380 U	380 U
Nitrobenzene	UG/KG	SV	380 U	380 U	380 U
Pentachlorophenol	UG/KG	SV	1900 U	1900 U	1900 U
Pyridine	UG/KG	SV	1900 U	1900 U	1900 U
Endrin	UG/KG	OC PEST	19 U	19 U	19 U
Gamma-BHC/Lindane	UG/KG	OC PEST	9.7 U	9.7 U	9.7 U
Heptachlor	UG/KG	OC PEST	9.7 U	9.7 U	9.7 U
Heptachlor epoxide	UG/KG	OC PEST	9.7 U	9.7 U	9.7 U
Methoxychlor	UG/KG	OC PEST	97 U	97 U	97 U
Toxaphene	UG/KG	OC PEST	190 U	190 U	190 U
Arsenic	MG/KG	M	4.5	4.6	5.9
Barium	MG/KG	M	93.3	101	130
Cadmium	MG/KG	M	0.28 U	0.31 J	0.46 J
Chromium	MG/KG	M	16.6	17.5	20.2
Lead	MG/KG	M	17.7 J	24.4 J	42.7 J
Mercury	MG/KG	M	0.05	0.06	0.16
Selenium	MG/KG	M	0.56 U	0.56 U	0.56 U
Silver	MG/KG	M	0.56 U	0.56 U	0.56 U
TCLP 1,1-Dichloroethene	UG/L	TCLP VOA			
TCLP 1,2-Dichloroethane	UG/L	TCLP VOA			
TCLP Benzene	UG/L	TCLP VOA			
TCLP Carbon tetrachloride	UG/L	TCLP VOA			
TCLP Chlorobenzene	UG/L	TCLP VOA			
TCLP Chloroform	UG/L	TCLP VOA			
TCLP Methyl ethyl ketone	UG/L	TCLP VOA			
TCLP Tetrachloroethene	UG/L	TCLP VOA			
TCLP Trichloroethene	UG/L	TCLP VOA			
TCLP Vinyl chloride	UG/L	TCLP VOA			
TCLP 2,4,5-Trichlorophenol	UG/L	TCLP SV			
TCLP 2,4,6-Trichlorophenol	UG/L	TCLP SV			

Table A-10A
SEAD-59 TCLP SOIL SAMPLE RESULTS
SEAD-59 and SEAD-71 Phase II RI Report
Seneca Army Depot Activity

Facility	SEAD-59	SEAD-59	SEAD-59
Location ID	WS-59-03-002-3	WS-59-03-002-4	WS-59-OTHERC-001-1
Maxtrix	SOIL	SOIL	SOIL
QC Code	SA	SA	SA
Study ID	ENSR IRM	ENSR IRM	ENSR IRM

Parameter	Units	Chem Class	Value (Q)	Value (Q)	Value (Q)
TCLP 2,4-Dinitrotoluene	UG/L	TCLP SV			
TCLP 2-Methylphenol	UG/L	TCLP SV			
TCLP Hexachlorobenzene	UG/L	TCLP SV			
TCLP Hexachlorobutadiene	UG/L	TCLP SV			
TCLP Hexachloroethane	UG/L	TCLP SV			
TCLP Nitrobenzene	UG/L	TCLP SV			
TCLP Pentachlorophenol	UG/L	TCLP SV			
TCLP Pyridine	UG/L	TCLP SV			
TCLP Endrin	UG/L	TCLP OCP			
TCLP Gamma-BHC/Lindane	UG/L	TCLP OCP			
TCLP Heptachlor	UG/L	TCLP OCP			
TCLP Heptachlor epoxide	UG/L	TCLP OCP			
TCLP Methoxychlor	UG/L	TCLP OCP			
TCLP Technical chlordane	UG/L	TCLP OCP			
TCLP Toxaphene	UG/L	TCLP OCP			
TCLP Arsenic	UG/L	TCLP M	500 U	500 U	500 U
TCLP Barium	UG/L	TCLP M	2000 UN	2000 UN	2000 UN
TCLP Cadmium	UG/L	TCLP M	100 U	100 U	100 U
TCLP Chromium	UG/L	TCLP M	100 U	100 U	100 U
TCLP Lead	UG/L	TCLP M	100 U	100 U	100 U
TCLP Mercury	UG/L	TCLP M	2 U	2 U	2 U
TCLP Selenium	UG/L	TCLP M	500 U	500 U	500 U
TCLP Silver	UG/L	TCLP M	100 U	100 U	100 U

Note(s):

(1) - All samples were collected during the 2002 TCRA; the samples pres

U = compound was not detected

J = the reported value is an estimated concentration

UJ = the compound was not detected; the associated reporting limit is app

R = the data was rejected in the data validating process

NJ = compound was "tentatively identified" and the associated numerical

Table A-10B
SEAD-71 TCLP SOIL SAMPLE RESULTS
SEAD-59 and SEAD-71 Phase II RI Report
Seneca Army Depot Activity

Facility Location ID Maxtrix QC Code Study ID	SEAD-71 FD-71-WS-08 SOIL SA ENSR IRM	SEAD-71 WS-71-B-009-12 SOIL SA ENSR IRM	SEAD-71 WS-71-C-009-4 SOIL SA ENSR IRM	SEAD-71 WS-71-C-009-5 SOIL SA ENSR IRM	SEAD-71 WS-71-D-009-11 SOIL SA ENSR IRM	SEAD-71 WS-71-D-009-13 SOIL SA ENSR IRM	SEAD-71 WS-71-D-009-2 SOIL SA ENSR IRM	SEAD-71 WS-71-E2-009-2 SOIL SA ENSR IRM	
Parameter	Units	Chem Class	Value (Q)	Value (Q)	Value (Q)	Value (Q)	Value (Q)	Value (Q)	Value (Q)
Arsenic	MG/KG	M	5.7 N	5.3 N		6.2 N	5.4	5.6	5.2
Barium	MG/KG	M	68.1	161		66.5	89.2	75.3	82.4
Cadmium	MG/KG	M	0.32 B	0.32 B		0.35 B	0.28 U	0.42 J	0.31 J
Chromium	MG/KG	M	17.1	15.7		17.4	17.5	18.1	18.6
Lead	MG/KG	M	222	1460		352	1010	97.5 J	588 J
Mercury	MG/KG	M	0.09	2.1		0.09	0.08	0.06	0.05 U
Selenium	MG/KG	M	0.56 UN	0.53 UN		0.55 UN	0.58 U	0.54 U	0.54 U
Silver	MG/KG	M	0.56 U	0.53 U		0.55 U	0.56 U	0.54 U	0.54 U
TCLP Arsenic	UG/L	TCLP M	500 U	500 U	500 U	500 U	500 U	500 U	500 U
TCLP Barium	UG/L	TCLP M	1000 U	1920	1270	2080	1000 U	1000 U	1000 U
TCLP Cadmium	UG/L	TCLP M	100 U	100 U	100 U	100 U	100 U	100 U	100 U
TCLP Chromium	UG/L	TCLP M	100 U	100 U	100 U	100 U	100 U	100 U	100 U
TCLP Lead	UG/L	TCLP M	100 U	3870	29500	9800	101	2040	100 U
TCLP Mercury	UG/L	TCLP M	1 U	1 U	2 U	2 U	1 U	2 U	2 U
TCLP Selenium	UG/L	TCLP M	500 U	500 U	500 U	500 U	500 U	500 U	500 U
TCLP Silver	UG/L	TCLP M	100 U	100 U	100 U	100 U	100 U	100 U	100 U

Note(s):

(1) - All samples were collected during the 2002 TCRA; the samples present have not been validated.

U = compound was not detected

J = the reported value is an estimated concentration

UJ = the compound was not detected; the associated reporting limit is approximate

R = the data was rejected in the data validating process

NJ = compound was "tentatively identified" and the associated numerical value is approximate

Table A-11A
SEAD-59 Soil TPH Data
SEAD-59 and SEAD-71 Phase II RI Report
Seneca Army Depot Activity

Site Location	SEAD-59	SEAD-59	SEAD-59	SEAD-59	SEAD-59	SEAD-59	SEAD-59
Location ID	MW59-4	MW59-6	SB59-1	SB59-1	SB59-1	SB59-1	SB59-10
Matrix	SOIL	SOIL	SOIL	SOIL	SOIL	SOIL	SOIL
Sample ID	59055	59129	SB59-1-01	SB59-1-08	SB59-1-04	SB59-1-06	59130
Sample Depth Top	4	1	0	6	6	10	0
Sample Depth Bottom	6	2.6	0.2	8	8	12	0.8
Sample Date	10/20/1997	10/24/1997	2/20/1994	2/20/1994	2/20/1994	2/20/1994	10/24/1997
Sample Type	SA	SA	SA	DU	SA	SA	SA
Investigation	RI PHASE 1 STEP 1	RI PHASE 1 STEP 1	ESI	ESI	ESI	ESI	RI PHASE 1 STEP 1

Parameter	Unit	Chem Class	Value (Q)	Value (Q)	Value (Q)	Value (Q)	Value (Q)	Value (Q)	Value (Q)
Total Petroleum Hydrocarbons	MG/KG	WC	27.7 U	50.2	380	182	220	78	26.8 U

Table A-11A
SEAD-59 Soil TPH Data
SEAD-59 and SEAD-71 Phase II RI Report
Seneca Army Depot Activity

Site Location	SEAD-59	SEAD-59	SEAD-59	SEAD-59	SEAD-59	SEAD-59
Location ID	SB59-11	SB59-13	SB59-14	SB59-15	SB59-16	SB59-17
Matrix	SOIL	SOIL	SOIL	SOIL	SOIL	SOIL
Sample ID	59132	59060	59062	59061	59064	59131
Sample Depth Top	3	6	0	4	0	8
Sample Depth Bottom	5	6.9	1.6	5.3	1.5	9.2
Sample Date	10/24/1997	10/21/1997	10/22/1997	10/21/1997	10/23/1997	10/23/1997
Sample Type	SA	SA	SA	SA	SA	DU
Investigation	RI PHASE 1 STEP 1	RI PHASE 1 STEP 1	RI PHASE 1 STEP 1	RI PHASE 1 STEP 1	RI PHASE 1 STEP 1	RI PHASE 1 STEP 1

Parameter	Unit	Chem Class	Value (Q)	Value (Q)	Value (Q)	Value (Q)	Value (Q)	Value (Q)
Total Petroleum Hydrocarbons	MG/KG	WC	24.2 U	691	197	24.7 U	2390	25.3 U

Table A-11A
SEAD-59 Soil TPH Data
SEAD-59 and SEAD-71 Phase II RI Report
Seneca Army Depot Activity

Site Location	SEAD-59	SEAD-59	SEAD-59	SEAD-59	SEAD-59	SEAD-59	SEAD-59	SEAD-59	SEAD-59	
Location ID	SB59-17	SB59-18	SB59-19	SB59-2	SB59-2	SB59-2	SB59-2	SB59-2	SB59-20	
Matrix	SOIL	SOIL	SOIL	SOIL	SOIL	SOIL	SOIL	SOIL	SOIL	
Sample ID	59068	59127	59065	SB59-2-20	SB59-2-00	SB59-2-02	SB59-2-04	59066		
Sample Depth Top	8	10	2	0	0	2	6	4		
Sample Depth Bottom	9.2	11	2.7	0.2	0.2	4	7	4.5		
Sample Date	10/23/1997	10/24/1997	10/22/1997	5/26/1994	5/26/1994	5/26/1994	5/26/1994	10/22/1997		
Sample Type	SA	SA	SA	DU	SA	SA	SA	SA		
Investigation	RI PHASE 1 STEP 1	RI PHASE 1 STEP 1	RI PHASE 1 STEP 1	ESI	ESI	ESI	ESI	RI PHASE 1 STEP 1		
Parameter	Unit	Chem Class	Value (Q)	Value (Q)	Value (Q)	Value (Q)	Value (Q)	Value (Q)	Value (Q)	Value
Total Petroleum Hydrocarbons	MG/KG	WC	22.7 U	1290	2880	774	951	513	69	24.8

Table A-11A
SEAD-59 Soil TPH Data
SEAD-59 and SEAD-71 Phase II RI Report
Seneca Army Depot Activity

Site Location	SEAD-59	SEAD-59	SEAD-59	SEAD-59	SEAD-59	SEAD-59	SEAD-59	SEAD-59	SEAD-59	SEAD-59	SEAD-59
Location ID	SB59-21	SB59-3	SB59-3	SB59-3	SB59-4	SB59-4	SB59-4	SB59-4	SB59-5	SB59-5	SB59-5
Matrix	SOIL	SOIL	SOIL	SOIL	SOIL	SOIL	SOIL	SOIL	SOIL	SOIL	SOIL
Sample ID	59067	SB59-3-00	SB59-3-02	SB59-3-04	SB59-4-00	SB59-4-05	SB59-4-10	SB59-5-00	SB59-5-03	SB59-5-06	
Sample Depth Top	0	0	2	6	0	8	10	0	4	10	
Sample Depth Bottom	1.1	0.2	4	8	0.2	10	20	0.2	6	12	
Sample Date	10/22/1997	5/25/1994	5/25/1994	5/25/1994	5/25/1994	5/25/1994	5/25/1994	5/25/1994	5/25/1994	5/25/1994	
Sample Type	SA	SA	SA	SA	SA	SA	SA	SA	SA	SA	
Investigation	RI PHASE 1 STEP 1	ESI	ESI	ESI	ESI	ESI	ESI	ESI	ESI	ESI	

Parameter	Unit	Chem Class (Q)	Value (Q)	Value (Q)	Value (Q)	Value (Q)	Value (Q)	Value (Q)	Value (Q)	Value (Q)	Value (Q)	Value (Q)
Total Petroleum Hydrocarbons	MG/KG	WC	26 U	1360	29 U	29 U	594	778	40	527	637	70

Table A-11A
SEAD-59 Soil TPH Data
SEAD-59 and SEAD-71 Phase II RI Report
Seneca Army Depot Activity

Site Location	SEAD-59	SEAD-59	SEAD-59	SEAD-59	SEAD-59	SEAD-59
Location ID	SB59-7	SB59-8	SB59-9	TP59-1	TP59-10-2	TP59-11A-2
Matrix	SOIL	SOIL	SOIL	SOIL	SOIL	SOIL
Sample ID	59056	59057	59059	TP59-1	59004	59026
Sample Depth Top	0	0	2	2	3	4
Sample Depth Bottom	2	2	3.7	2	3.5	4.5
Sample Date	10/20/1997	10/20/1997	10/21/1997	6/8/1994	10/7/1997	10/9/1997
Sample Type	SA	SA	SA	SA	SA	SA
Investigation	RI PHASE 1 STEP 1	RI PHASE 1 STEP 1	RI PHASE 1 STEP 1	ESI	RI PHASE 1 STEP 1	RI PHASE 1 STEP 1

Parameter	Unit	Chem Class (Q)	Value (Q)	Value (Q)	Value (Q)	Value (Q)	Value (Q)	Value (Q)
Total Petroleum Hydrocarbons	MG/KG	WC	133	27.3 U	23.3 U	3820	607	1220

Table A-11A
SEAD-59 Soil TPH Data
SEAD-59 and SEAD-71 Phase II RI Report
Seneca Army Depot Activity

Site Location	SEAD-59	SEAD-59	SEAD-59	SEAD-59	SEAD-59	SEAD-59		
Location ID	TP59-12A-1	TP59-12A-2	TP59-12B-2	TP59-13A-1	TP59-13C-1	TP59-14-3		
Matrix	SOIL	SOIL	SOIL	SOIL	SOIL	SOIL		
Sample ID	59018	59019	59023	59010	59015	59030		
Sample Depth Top	1	1	2.5	3.5	3	1.5		
Sample Depth Bottom	1.5	1.5	3	4	3.5	2		
Sample Date	10/9/1997	10/9/1997	10/9/1997	10/8/1997	10/8/1997	10/10/1997		
Sample Type	SA	DU	SA	SA	SA	SA		
Investigation	RI PHASE 1 STEP 1	RI PHASE 1 STEP 1	RI PHASE 1 STEP 1	RI PHASE 1 STEP 1	RI PHASE 1 STEP 1	RI PHASE 1 STEP 1		
Parameter	Unit	Chem Class	Value (Q)	Value (Q)	Value (Q)	Value (Q)	Value (Q)	
Total Petroleum Hydrocarbons	MG/KG	WC	156	151	25.8 U	5090	25.4 U	430

Table A-11A
SEAD-59 Soil TPH Data
SEAD-59 and SEAD-71 Phase II RI Report
Seneca Army Depot Activity

Site Location	SEAD-59	SEAD-59	SEAD-59	SEAD-59	SEAD-59	SEAD-59	SEAD-59
Location ID	TP59-15-1	TP59-15-5	TP59-16-1	TP59-17-3	TP59-18-1	TP59-2	TP59-3
Matrix	SOIL	SOIL	SOIL	SOIL	SOIL	SOIL	SOIL
Sample ID	59031	59035	59036	59044	59047	TP59-2	TP59-3-1
Sample Depth Top	6	6	3.5	3	2	7	3
Sample Depth Bottom	6	6.5	4	3.5	2.5	7	3
Sample Date	10/10/1997	10/10/1997	10/10/1997	10/13/1997	10/13/1997	2/20/1994	6/8/1994
Sample Type	SA	SA	SA	SA	SA	SA	SA
Investigation	RI PHASE 1 STEP 1	RI PHASE 1 STEP 1	RI PHASE 1 STEP 1	RI PHASE 1 STEP 1	RI PHASE 1 STEP 1	ESI	ESI

Parameter	Unit	Chem Class	Value (Q)	Value (Q)	Value (Q)	Value (Q)	Value (Q)	Value (Q)	Value (Q)
Total Petroleum Hydrocarbons	MG/KG	WC	19700	667	218	23.8 U	25.6 U	1790	440

Table A-11A
SEAD-59 Soil TPH Data
SEAD-59 and SEAD-71 Phase II RI Report
Seneca Army Depot Activity

Parameter	Unit	Chem Class	Value (Q)	Value (Q)	Value (Q)	Value (Q)	Value (Q)
Total Petroleum Hydrocarbons	MG/KG	WC	7870	111	393	55.3	27.6 U

Site Location	SEAD-59	SEAD-59	SEAD-59	SEAD-59	SEAD-59
Location ID	TP59-4	TP59-6-2	TP59-7-2	TP59-8-2	TP59-9-2
Matrix	SOIL	SOIL	SOIL	SOIL	SOIL
Sample ID	TP59-4	59002	59008	59050	59052
Sample Depth Top	2	6	3	1.5	2
Sample Depth Bottom	2	6.5	3.5	2	2.5
Sample Date	6/8/1994	10/7/1997	10/8/1997	10/13/1997	10/13/1997
Sample Type	SA	SA	SA	SA	SA
Investigation	ESI	RI PHASE 1 STEP 1	RI PHASE 1 STEP 1	RI PHASE 1 STEP 1	RI PHASE 1 STEP 1

Table A-11B
SEAD-71 Soil TPH Data
SEAD-59 and SEAD-71 Phase II RI Report
Seneca Army Depot Activity

	SEAD-71	SEAD-71	SEAD-71	SEAD-71	SEAD-71	SEAD-71		
Site Location	SEAD-71	SEAD-71	SEAD-71	SEAD-71	SEAD-71	SEAD-71		
Location ID	SS71-1	SS71-10	SS71-11	SS71-12	SS71-13	SS71-14		
Matrix	SOIL	SOIL	SOIL	SOIL	SOIL	SOIL		
Sample ID	71013	71017	71024	71023	71027	71025		
Sample Depth Top	0	0	0	0	0	0		
Sample Depth Bottom	0.2	0.2	0.2	0.2	0.2	0.2		
Sample Date	11/19/1997	11/19/1997	11/20/1997	11/20/1997	11/21/1997	11/20/1997		
Sample Type	SA	SA	SA	SA	SA	SA		
Investigation	RI PHASE 1 STEP 1	RI PHASE 1 STEP 1	RI PHASE 1 STEP 1	RI PHASE 1 STEP 1	RI PHASE 1 STEP 1	RI PHASE 1 STEP 1		
Parameter	Unit	Chem Class	Value (Q)	Value (Q)	Value (Q)	Value (Q)	Value (Q)	
Total Petroleum Hydrocarbons	MG/KG	WC	243	26 U	29.7 U	182	325	45.3

Table A-11B
SEAD-71 Soil TPH Data
SEAD-59 and SEAD-71 Phase II RI Report
Seneca Army Depot Activity

	SEAD-71	SEAD-71	SEAD-71	SEAD-71	SEAD-71	SEAD-71		
Site Location	SEAD-71	SEAD-71	SEAD-71	SEAD-71	SEAD-71	SEAD-71		
Location ID	SS71-15	SS71-16	SS71-17	SS71-18	SS71-19	SS71-2		
Matrix	SOIL	SOIL	SOIL	SOIL	SOIL	SOIL		
Sample ID	71032	71021	71030	71022	71020	71014		
Sample Depth Top	0	0	0	0	0	0		
Sample Depth Bottom	0.2	0.2	0.2	0.2	0.2	0.2		
Sample Date	11/21/1997	11/20/1997	11/21/1997	11/20/1997	11/20/1997	11/19/1997		
Sample Type	SA	SA	SA	SA	SA	SA		
Investigation	RI PHASE 1 STEP 1	RI PHASE 1 STEP 1	RI PHASE 1 STEP 1	RI PHASE 1 STEP 1	RI PHASE 1 STEP 1	RI PHASE 1 STEP 1		
Parameter	Unit	Chem Class	Value (Q)	Value (Q)	Value (Q)	Value (Q)	Value (Q)	
Total Petroleum Hydrocarbons	MG/KG	WC	5220	1120	411	851	307	90.4

Table A-11B
SEAD-71 Soil TPH Data
SEAD-59 and SEAD-71 Phase II RI Report
Seneca Army Depot Activity

	SEAD-71	SEAD-71	SEAD-71	SEAD-71	SEAD-71	SEAD-71		
Site Location	SEAD-71	SEAD-71	SEAD-71	SEAD-71	SEAD-71	SEAD-71		
Location ID	SS71-20	SS71-3	SS71-4	SS71-5	SS71-6	SS71-7		
Matrix	SOIL	SOIL	SOIL	SOIL	SOIL	SOIL		
Sample ID	71031	71015	71016	71029	71028	71203		
Sample Depth Top	0	0	0	0	0	0		
Sample Depth Bottom	0.2	0.2	0.2	0.2	0.2	0.2		
Sample Date	11/21/1997	11/19/1997	11/19/1997	11/21/1997	11/21/1997	11/20/1997		
Sample Type	SA	SA	SA	SA	SA	DU		
Investigation	RI PHASE 1 STEP 1	RI PHASE 1 STEP 1	RI PHASE 1 STEP 1	RI PHASE 1 STEP 1	RI PHASE 1 STEP 1	RI PHASE 1 STEP 1		
Parameter	Unit	Chem Class	Value (Q)	Value (Q)	Value (Q)	Value (Q)	Value (Q)	
Total Petroleum Hydrocarbons	MG/KG	WC	343	100	53.6	29	174	89

Table A-11B
SEAD-71 Soil TPH Data
SEAD-59 and SEAD-71 Phase II RI Report
Seneca Army Depot Activity

	SEAD-71	SEAD-71	SEAD-71	SEAD-71	SEAD-71	SEAD-71		
Site Location	SEAD-71	SEAD-71	SEAD-71	SEAD-71	SEAD-71	SEAD-71		
Location ID	SS71-7	SS71-8	SS71-9	TP71-3-1	TP71-3-2	TP71-4-2		
Matrix	SOIL	SOIL	SOIL	SOIL	SOIL	SOIL		
Sample ID	71026	71019	71018	71002	71003	71006		
Sample Depth Top	0	0	0	0	10.5	10		
Sample Depth Bottom	0.2	0.2	0.2	8	11	10.5		
Sample Date	11/20/1997	11/19/1997	11/19/1997	10/14/1997	10/14/1997	10/14/1997		
Sample Type	SA	SA	SA	SA	SA	SA		
Investigation	RI PHASE 1 STEP 1	RI PHASE 1 STEP 1	RI PHASE 1 STEP 1	RI PHASE 1 STEP 1	RI PHASE 1 STEP 1	RI PHASE 1 STEP 1		
Parameter	Unit	Chem Class	Value (Q)	Value (Q)	Value (Q)	Value (Q)	Value (Q)	
Total Petroleum Hydrocarbons	MG/KG	WC	78.6	292	148	1800	9060	23.3 U

**Table A-11B
SEAD-71 Soil TPH Data
SEAD-59 and SEAD-71 Phase II RI Report
Seneca Army Depot Activity**

Site Location	SEAD-71	SEAD-71
Location ID	TP71-5-1	TP71-6-1
Matrix	SOIL	SOIL
Sample ID	71007	71010
Sample Depth Top	7	12.5
Sample Depth Bottom	7.5	13
Sample Date	10/14/1997	10/15/1997
Sample Type	SA	SA
Investigation	RI PHASE 1 STEP 1	RI PHASE 1 STEP 1

Parameter	Unit	Chem Class	Value (Q)	Value (Q)
Total Petroleum Hydrocarbons	MG/KG	WC	24.4 U	74 U

Table A-12
 SEAD-59 ESI Groundwater TPH Data
 SEAD-59 and SEAD-71 Phase II RI Report
 Seneca Army Depot Activity

COMPOUND	MATRIX LOCATION	MAXIMUM	FREQUENCY OF DETECTION	NY AWQS CLASS GA (a)	FEDERAL DRINKING WATER	NUMBER ABOVE CRITERIA	WATER	WATER	WATER
	ES ID				MCL (f)		SEAD-59	SEAD-59	SEAD-59
	SDG NUMBER						03/30/94	07/21/94	07/21/94
	UNITS						MW59-1	MW59-2	MW59-3
							216048	227726	227727
							43179	45448	45448
SEMIVOLATILE ORGANICS									
Phenol	ug/L	2	67%	1	NA	1	10 U	2 J	1 J
METALS									
Aluminum	ug/L	2680	100%	NA	NA	NA	1940	299	2680
Arsenic	ug/L	2	33%	25	50	0	2 J	2 U	2 U
Barium	ug/L	103	100%	1000	2000	0	102 J	99.6 J	103 J
Calcium	ug/L	146000	100%	NA	NA	NA	140000	125000	146000
Chromium	ug/L	3.6	100%	50	100	0	3.4 J	0.78 J	3.6 J
Cobalt	ug/L	3.5	100%	NA	NA	NA	3.5 J	1.1 J	2.1 J
Copper	ug/L	4.3	67%	200	1300 (g)	0	4.3 J	0.5 U	3.6 J
Iron	ug/L	3940	100%	300	NA	3	3120	731 J	3940 J
Lead	ug/L	2.4	67%	25	15 (h)	0	2.4 J	0.9 U	1.5 J
Magnesium	ug/L	29200	100%	NA	NA	NA	29000	29200	21200
Manganese	ug/L	780	100%	300	NA	1	780	109	253
Mercury	ug/L	0.06	67%	2	2	0	0.03 U	0.05 J	0.06 J
Nickel	ug/L	7.6	100%	NA	100	0	7.6 J	1.9 J	6.7 J
Potassium	ug/L	4150	100%	NA	NA	NA	2110 J	2640 J	4150 J
Sodium	ug/L	239000	100%	20000	NA	3	66000	32100	239000
Thallium	ug/L	4	67%	NA	2	2	1.6 U	4 J	2.8 J
Vanadium	ug/L	4.7	100%	NA	NA	NA	3.4 J	1.1 J	4.7 J
Zinc	ug/L	26.2	100%	300	NA	0	21.8	4 J	26.2
OTHER ANALYSES									
Total Petroleum Hydrocarbons	mg/L	2.6		NA	NA	NA	2.6 J	1.38	0.34 U
pH	Standard Units						7.2	7.9	7.1
Conductivity	umhos/cm						650	750	1600
Temperature	°C						3.9	14.6	17.6
Turbidity	NTU						146	14	56

NOTES:

- a) NY State Class GA Groundwater Regulations
- b) NA = Not Available
- d) U = The compound was not detected below this concentration.
- e) J = The reported value is an estimated concentration.
- f) Federal Primary Drinking Water Maximum Contaminant Levels.
- g) The value listed is an action level for copper at the tap, and not an M
- h) The value listed is an action level for lead at the tap, and not an MCL.

Appendix B

Background Data

- B-1 Background Soil Data
- B-2 Background Groundwater Data

**TABLE B-1
SOIL BACKGROUND DATA
SEAD-59 AND SEAD-71 PHASE II RI REPORT
SENECA ARMY DEPOT ACTIVITY**

LOC_ID:	B-8-91	B-8-91	B-8-91	B-8-91	B-9-91	B-9-91	B-9-91	BK-1	BK-2
QC CODE:	SA	SA	SA	SA	SA	SA	SA	SA	SA
STUDY ID:	RI PHASE1	RI PHASE1	RI PHASE1	RI PHASE1	RI PHASE1	RI PHASE1	RI PHASE1	RI PHASE1	RI PHASE1
TOP:									
BOTTOM:									
MATRIX:	SOIL	SOIL	SOIL	SOIL	SOIL	SOIL	SOIL	SOIL	SOIL
SAMPLE DATE:	11/05/91	11/05/91	11/05/91	11/05/91	11/05/91	11/05/91	11/05/91	12/16/92	12/16/92
SAMP ID:	S1105-24SOIL1	S1105-25SOIL1	S1105-26(1)SOIL1	S1105-27SOIL1	S1105-28SOIL1	S1105-29SOIL1	S1105-30RESOIL1	BK-1SOIL3	BK-2RESOIL3
METALS	VALUE (Q)	VALUE (Q)	VALUE (Q)	VALUE (Q)	VALUE (Q)	VALUE (Q)	VALUE (Q)	VALUE (Q)	VALUE (Q)
Aluminum	19200	20500	17700	12700	14800	8880	7160	19400	14400
Antimony	10.3 UJ	8.8 UJ	8.2 UJ	8.4 UJ	9.9 UJ	9.9 UJ	7 UJ	7.9 U	7.2 U
Arsenic	5.1 J	6.1 J	6 J	4.2 J	4.3 J	3.8 J	4.4 J	3	2.7
Barium	136 J	98.9 J	86.7 J	56.2 J	101 J	110 J	39.9 J	159	106
Beryllium	1.4	1.2	1	0.78 J	1.1	0.76	0.52 J	1.1	0.81
Cadmium	2.6	2.9	2.4	1.9	2.3	1.7	1.5	0.45 U	0.41 U
Calcium	5390	4870	3560	85900	45600	104000	101000	4590	22500
Chromium	27.4 J	30.1 J	26.9 J	19.8 J	22.5 J	13.8 J	11.2 J	30	22.3
Cobalt	13.8	18.4	14	14.2	13.7	10.7	8.1	14.4	12.3
Copper	22.3	27.6	26	16.2	22.6	21.6	19.3	26.9	18.8
Cyanide	0.6 U	0.63 U	0.67 U	0.58 U	0.7 U	0.63 U	0.62 U	0.57 U	0.61 U
Iron	37200	36100	32500	27400	31000	19600	17300	38600	26600
Lead	14.5	11.4	13.6	10.1	10.8	10.1	7.8	15.8	18.9
Magnesium	5850	7300	6490	6720	8860	17000	12600	5980	7910
Manganese	1130	956	832	926	903	532	514	2380	800
Mercury	0.09	0.06 J	0.06 J	0.05 J	0.08 J	0.04 J	0.05 J	0.13 J	0.11
Nickel	42.3	48.7	44.4	30.4	38.4	23.8	19	47.7	31
Potassium	1910	2110	1760	1430	1320	1080	1050	1720	1210
Selenium	0.17 UJ	0.21 UJ	0.2 UJ	0.61 UJ	0.21 UJ	0.65 UJ	0.21 UJ	0.73 J	0.94
Silver	1.6 U	1.3 U	1.2 U	1.3 U	1.5 U	1.5 U	1.1 U	0.47 U	0.43 U
Sodium	79.2 U	67.5 U	62.6 U	75.3 J	84.2 J	112 J	116 J	49.1 J	61.1 J
Thallium	0.47 U	0.58 U	0.57 U	0.34 U	0.59 U	0.36 U	0.6 U	0.42 U	0.38 U
Vanadium	32.2	25.4	26.4	15.7	19.7	19.5	12.9	28	22.4
Zinc	85.1 J	94.2 J	85 J	75 J	126 J	84.3 J	74.8 J	98.6	63.7
U = compound was not detected									
J = the reported value is an estimated concentration									
UJ = the compound was not detected; the associated reporting limit is approximate									
R = the data was rejected in the data validating process									
NJ = compound was "tentatively identified" and the associated numerical value is approximate									

**TABLE B-1
SOIL BACKGROUND DATA
SEAD-59 AND SEAD-71 PHASE II RI REPORT
SENECA ARMY DEPOT ACTIVITY**

LOC_ID:	GB35	GB35	GB35	GB36	GB36	MW-36	MW-34	SB24-5	SB24-5
QC CODE:	SA	SA	DU	SA	SA	SA	SA	SA	SA
STUDY ID:	RI PHASE1	RI PHASE1	RI PHASE1	RI PHASE1	RI PHASE1	RI Phase 1 Step 1	RI PHASE1	ESI	ESI
TOP:						-1		-1	-1
BOTTOM:						-1		-1	-1
MATRIX:	SOIL	SOIL	SOIL	SOIL	SOIL	SOIL	SOIL	SOIL	SOIL
SAMPLE DATE:	01/20/93	01/20/93	01/20/93	01/20/93	01/20/93	01/11/93	11/20/91	12/02/93	12/02/93
SAMP ID:	GB35-1GRID	GB35-2GRID	GB35-6DUGRID	GB36-1GRID	GB36-2GRID	MW36-3GRID	S2011121MW34GRID	SB24-5-1	SB24-5-3
METALS	VALUE (Q)	VALUE (Q)	VALUE (Q)	VALUE (Q)	VALUE (Q)	VALUE (Q)	VALUE (Q)	VALUE (Q)	VALUE (Q)
Aluminum	18000	17600	16200	18100	16200	12700	16100	16200	10100
Antimony	5.8 UJ	6.8 J	6.3 J	5.9 J	5.8 UJ	5.7 UJ	5.7 J	12.5 UJ	5.8 UJ
Arsenic	6.2	7.7	5.3	4.6	9.7	2.9 J	6.3 U	4.2	3.3
Barium	93.6	61.7	61.7	74.8	50.8	46.9 J	67.5	117	58.3
Beryllium	0.85	0.74	0.77	0.77	0.65	0.59	0.86	0.98 J	0.48 J
Cadmium	0.33 U	0.31 U	0.35 U	0.3 U	0.33 U	0.33 U	2.3	0.78 U	0.36 U
Calcium	1590	17700	1370	1660	22900	4170	28600	4540	74200
Chromium	23.5	29.3	25.1	24.8	27.4	23.3 J	26.6	24.5	16.9
Cobalt	9.4	16.3	10.3	20.4	13.2	18.6	17	16	8.2
Copper	17.5	24.5	17.2	17.7	17.5	19.2 J	32.7	28.4	20.9
Cyanide	0.78 U	0.71 U	0.82 U	0.7 U	0.68 U	0.56 U	0.54 U	0.6 U	0.51 U
Iron	25200	34200	30800	26100	30700	27500	35000	33600	21300
Lead	14.4	5.4	19.1	12.7	6.2	20.2	11.9	45.5 J	8.7 J
Magnesium	3850	7790	4490	4490	7150	5750	6850	5150	12100
Manganese	701	646	775	426	507	540	803	1080	400
Mercury	0.06 J	0.03 U	0.07 J	0.02 J	0.02 J	0.02 J	0.07 R	0.07 JR	0.06 JR
Nickel	26.3	48.7	28.3	28.3	42.8	43.3 J	49.3 J	37.3	26.4
Potassium	1110	1110	975	1400	1100	754	1290	1170 J	993
Selenium	0.23 UJ	0.23 UJ	0.21 UJ	0.2 UJ	0.18 UJ	0.19 UJ	0.18 UJ	0.15 UJ	0.23 UJ
Silver	0.34 U	0.32 U	0.36 U	0.31 U	0.34 U	0.34 U	0.87 J	1.6 U	0.73 U
Sodium	35.6 J	77.5 J	34.6 J	46.6 J	97.6 J	31.6 U	55.2 J	50.9 J	153 J
Thallium	0.55 U	0.54 U	0.5 U	0.46 U	0.43 U	0.45 U	0.51 U	0.16 U	0.25 U
Vanadium	27.1	22.3	26.1	27.8	19.7	16.2 J	22.3	29.9	14.4
Zinc	55	83.4	53.1	59.2	74.1	34.7 J	95.7	85.7	62.8
U = compound was not detected									
J = the reported value is an estimated concentration									
UJ = the compound was not detected; the associated reporting limit is approximate									
R = the data was rejected in the data validating process									
NJ = compound was "tentatively identified" and the associated numerical value is approximate									

**TABLE B-1
SOIL BACKGROUND DATA
SEAD-59 AND SEAD-71 PHASE II RI REPORT
SENECA ARMY DEPOT ACTIVITY**

LOC_ID:	SB24-5	MW25-1	MW25-1	MW25-6	MW25-6	MW25-6	MW25-6	MW25-6	MW64A-1	MW64A-1
QC CODE:	SA	SA	SA	SA	SA	SA	DU	SA	SA	SA
STUDY ID:	ESI	ESI	ESI	RI ROUND1	RI ROUND1	RI ROUND1	RI ROUND1	ESI	ESI	ESI
TOP:	-1	0	2	0	4	6	0	0	2	2
BOTTOM:	-1	2	4	0.17	6	8	0.17	0.2	4	4
MATRIX:	SOIL	SOIL	SOIL	SOIL	SOIL	SOIL	SOIL	SOIL	SOIL	SOIL
SAMPLE DATE:	12/02/93	12/03/93	12/03/93	09/25/95	09/25/95	09/25/95	09/25/95	04/02/94	04/02/94	04/02/94
SAMP ID:	SB24-5-5	SB25-6-01	SB25-6-02	SB25-7-00	SB25-7-03	SB25-7-04	SB25-7-10	MW64A-1-1	MW64A-1-2	MW64A-1-2
METALS	VALUE (Q)	VALUE (Q)	VALUE (Q)	VALUE (Q)	VALUE (Q)	VALUE (Q)	VALUE (Q)	VALUE (Q)	VALUE (Q)	VALUE (Q)
Aluminum	13700	10600	7070	12500	8020	7550	12500	16100	19800	19800
Antimony	11.3 UJ	4.2 U	3 U	0.4	0.42 UJ	0.44 U	0.4 UJ	0.23 J	0.2 UJ	0.2 UJ
Arsenic	5	8.3	4.8	4.3	4.1	3.4	4.3	7.1	8.2	8.2
Barium	67.2	59.1	35	71.3	58	52	71.3	83.7	91.2	91.2
Beryllium	0.62 J	0.48 J	0.35 J	0.56	0.43	0.39	0.56	0.68 J	0.74 J	0.74 J
Cadmium	0.7 U	0.41 U	0.29 U	0.05 U	0.06 U	0.06 U	0.05 U	0.11 J	0.02 U	0.02 U
Calcium	49000	82500	122000	47400 J	120000 J	133000 J	47400 J	7210	4300	4300
Chromium	23.1	16.9	11.3	16.9 J	13.7 J	12.4 J	16.9 J	23	25	25
Cobalt	12	11.2	6.6 J	8	8.2	6.9	8	11.8	11.3	11.3
Copper	22.2	20.2 J	12 J	15.7	17.7	16.4	15.7	25.5	21	21
Cyanide	0.57 U	0.58 U	0.64 U	0.44 U	0.57 U	0.51 U	0.444 U	0.66 U	0.56 U	0.56 U
Iron	26700	21400	15800	20500	18900	15400	20500	28500	28000	28000
Lead	7.9 J	9.5	13.8	11.1	7	6.5	11.1	21.6	13.6	13.6
Magnesium	11400	19600	22800	11700	17400	20700	11700	5480	5010	5010
Manganese	450	722 J	610 J	452	735	402	452	558	604	604
Mercury	0.04 JR	0.03 J	0.04 U	0.03	0.02	0.01	0.03	0.05 J	0.03 J	0.03 J
Nickel	35.2	26.8	18	22.3	26.4	22.4	22.3	32.2	28.6	28.6
Potassium	1660	1480	1060	1110	1280	1430	1110	2590 J	2260 J	2260 J
Selenium	0.22 UJ	0.97 J	0.63 J	0.63 U	0.7 U	0.74 U	0.66 U	0.96	1.7	1.7
Silver	1.4 U	0.82 U	0.59 U	0.89 U	0.98 U	1 U	0.92 U	0.12 U	0.14 U	0.14 U
Sodium	139 J	269 J	186 J	59.9	89.1	110	57.5	27.5 U	31.8 U	31.8 U
Thallium	0.24 U	0.24 UJ	0.21 UJ	1.2	1.1	0.6 U	1.2	0.42 J	0.32 U	0.32 U
Vanadium	19.5	18.5	12	21	13.4	13.7	21	27.6	32.2	32.2
Zinc	63.2	71.6 J	40.6 J	54.1	64.9	65.1	54.1	104	87.1	87.1
U = compound was not detected										
J = the reported value is an estimated concentration										
UJ = the compound was not detected; the associated reporting limit is approximate										
R = the data was rejected in the data validating process										
NJ = compound was "tentatively identified" and the associated numerical value is approximate										

**TABLE B-1
SOIL BACKGROUND DATA
SEAD-59 AND SEAD-71 PHASE II RI REPORT
SENECA ARMY DEPOT ACTIVITY**

LOC_ID:	MW64A-1	MW64B-1	MW64B-1	MW64B-1	MW64B-1	MW64B-1	MW67-2	MW67-2	MW67-2	MW70-1
QC CODE:	SA	SA	SA	SA	SA	SA	SA	SA	SA	SA
STUDY ID:	ESI	ESI	ESI	ESI	ESI	ESI	ESI	ESI	ESI	ESI
TOP:	4	0	4	6	6	0	2	4	0	
BOTTOM:	6	0.2	6	8	8	0.2	4	5	0.2	
MATRIX:	SOIL	SOIL	SOIL	SOIL	SOIL	SOIL	SOIL	SOIL	SOIL	SOIL
SAMPLE DATE:	04/02/94	05/13/94	05/13/94	05/13/94	05/13/94	03/30/94	03/30/94	03/30/94	03/30/94	05/11/94
SAMP ID:	MW64A-1-3	MW64B-1-1	MW64B-1-2	MW64B-1-3	MW64B-1-04	MW67-2-1	MW67-2-2	MW67-2-3	MW70-1-1	
METALS	VALUE (Q)	VALUE (Q)	VALUE (Q)	VALUE (Q)	VALUE (Q)	VALUE (Q)	VALUE (Q)	VALUE (Q)	VALUE (Q)	VALUE (Q)
Aluminum	12600	13400	8870	7620	7620	16700	14900	9460	12200	
Antimony	0.2 UJ	0.3 J	0.15 UJ	0.15 UJ	0.15 UJ	0.27 J	0.22 J	0.2 UJ	0.23 UJ	
Arsenic	5	5.5	4.3	5.5	5.5	4.4	4.5	4.2	5.4	
Barium	62.3	75.5	70.8	76.7	76.7	114	105	80.8	67.5	
Beryllium	0.53 J	0.56 J	0.43 J	0.37 J	0.37 J	0.67 J	0.61 J	0.4 J	0.44 J	
Cadmium	0.12 J	0.63 J	0.64 J	0.54 J	0.54 J	0.2 J	0.11 J	0.12 J	0.57 J	
Calcium	72400	5530	70000	75900	75900	3580	79000	77800	3600	
Chromium	19	17.5	14.1	13.5	13.5	19.5	22.5	14.8	13.7	
Cobalt	9.1 J	7.2 J	10	7.4 J	7.4 J	7.5 J	10.4 J	9.7 J	5.5 J	
Copper	23.7	18.9	20.2	17.6	17.6	16.5	20.3	20.5	12.4	
Cyanide	0.55 U	0.6 U	0.5 U	0.48 U	0.48 U	0.64 U	0.5 U	0.54 U		
Iron	22600	20900	18400	17100	17100	20500	24400	18700	17700	
Lead	15.4	21.4	8.8	8.3	8.3	17.5	9.3	8.5	20.7	
Magnesium	14800	3720	18900	21500	21500				2830	
Manganese	402	207	434	389	389	438	528	411	233	
Mercury	0.02 J	0.05 J	0.02 J	0.01 U	0.01 U	0.04	0.01 J	0.02 J	0.1 J	
Nickel	26.7	19.8	28.2	22.6	22.6	18.7	32.3	25.9	12.3	
Potassium	2700 J	1700	1630	1650	1650	1780 J	3160 J	1970 J	982 J	
Selenium	0.34 U	0.99 J	0.26 U	0.57 J	0.57 J	0.81	0.36 U	0.34 U	1 J	
Silver	0.14 U	0.16 UJ	0.11 UJ	0.11 UJ	0.11 UJ	0.11 U	0.15 U	0.14 U		
Sodium	92.1 J	35.9 U	96.8 J	79.6 J	79.6 J	25.1 U	112 J	107 J	36.4 U	
Thallium	0.32 U	0.41 J	0.24 U	0.24 U	0.24 U	0.48 J	0.34 U	0.32 U		
Vanadium	22.8	23.3	14.8	14.2	14.2	28.2	24.8	16.5	23.3	
Zinc	64.9	72.2	59	45.6	45.600	64.8	62	60.1	55.4	
U = compound was not detected										
J = the reported value is an estimated concentration										
UJ = the compound was not detected; the associated reporting limit is approximate										
R = the data was rejected in the data validating process										
NJ = compound was "tentatively identified" and the associated numerical value is approximate										

**TABLE B-1
SOIL BACKGROUND DATA
SEAD-59 AND SEAD-71 PHASE II RI REPORT
SENECA ARMY DEPOT ACTIVITY**

LOC_ID:	MW70-1	MW70-1	SB11-3	SB11-3	SB11-3	SB13-1	SB13-1	SB13-1	MW13-6
QC CODE:	SA	SA	SA	SA	SA	SA	SA	SA	SA
STUDY ID:	ESI	ESI	ESI	ESI	ESI	ESI	ESI	ESI	ESI
TOP:	2	4	0	2	10	0		6	0
BOTTOM:	4	6	2	4	12	2		8	2
MATRIX:	SOIL	SOIL	SOIL	SOIL	SOIL	SOIL	SOIL	SOIL	SOIL
SAMPLE DATE:	05/11/94	05/11/94	11/02/93	11/02/93	11/03/93	12/08/93		12/08/93	12/15/93
SAMP ID:	MW70-1-2	MW70-1-3	SB11-3-1	SB11-3-2	SB11-3-6	SB13-1-1	SB13-1-2	SB13-1-3	SB13-6-1
METALS	VALUE (Q)	VALUE (Q)	VALUE (Q)	VALUE (Q)	VALUE (Q)	VALUE (Q)	VALUE (Q)	VALUE (Q)	VALUE (Q)
Aluminum	9480	11000	17600	6330	10900	18300	8250	11700	16000
Antimony	0.21 UJ	0.19 UJ	10.8 UJ	8 UJ	7.6 UJ	5.1 J	3.7 UJ	2.8 UJ	3.2 UJ
Arsenic	4.1	5.7	5.6 R	3.4 R	6 R	7	6.2	5.7	4.6
Barium	56.6	79.9	113	57.4	62.7	106	88.1	33.9	103
Beryllium	0.41 J	0.54 J	0.85 J	0.34 J	0.47 J	0.92 J	0.42 J	0.54 J	0.92
Cadmium	0.43 J	0.8 J	0.67 U	0.5 U	0.48 U	0.45 U	0.36 U	0.27 U	0.31 U
Calcium	51600	48600	4950	91300	48600	3570	87700	50300	5140
Chromium	14.7	17.8	24	11.1	18.6	29.4	13.3	19.6	21.5
Cobalt	7.1 J	21	11.3	6.5 J	10.1	12	7.2 J	11.1	10.6
Copper	19.7	33.5	20	12.2	21.7	11.6	18.4	17.6	16
Cyanide			0.57 U	0.47 U	0.53 U	0.61 U	0.5 U	0.53 U	0.6 U
Iron	16000	26400	27200	13200	28300	32500	17400	24700	25300
Lead	9.1	13.6	27.9	11.4	10.1	15 R	9 R	11.7 R	13.8
Magnesium	13600	7980	4160	12900	10100	5890	20800	12600	3750
Manganese	470	1040	674	356	434	451	517	404	934
Mercury	0.03 J	0.02 J	0.05 J	0.04 U	0.03 U	0.03 J	0.07 J	0.02 U	0.03 J
Nickel	17.6	52.4	28.3	16.7	29.5	34.9	24	33.1	22.7
Potassium	1590	1350	2110	1110	1230	2190	1390	1270	1330
Selenium	0.64 J	0.32 U	0.24 J	0.13 UJ	0.21 UJ	0.26 J	0.56 J	0.51 J	1.2
Silver			1.4 UJ	1 UJ	0.97 UJ	0.9 U	0.71 U	0.54 U	0.62 U
Sodium	126 J	165 J	66.3 J	136 J	146 J	80.6 J	155 J	134 J	61.9 J
Thallium			0.19 U	1.5 U	0.23 U	0.43 J	0.43 J	0.64 J	0.18 U
Vanadium	17.2	17.6	31.8	13.3	17	32.7	13.3	16.3	29.9
Zinc	42.4	116	83.2 R	65 R	77.3 R	81.9	56.2	45.8	62.5
U = compound was not detected									
J = the reported value is an estimated concentration									
UJ = the compound was not detected; the associated reporting limit is approximate									
R = the data was rejected in the data validating process									
NJ = compound was "tentatively identified" and the associated numerical value is approximate									

**TABLE B-1
SOIL BACKGROUND DATA
SEAD-59 AND SEAD-71 PHASE II RI REPORT
SENECA ARMY DEPOT ACTIVITY**

LOC_ID:	MW13-6	MW13-6	SB17-1	SB17-1	SB17-1	SB26-1	SB26-1	SB4-1	SB4-1
QC CODE:	SA	SA	SA	SA	SA	SA	SA	SA	DU
STUDY ID:	ESI	ESI	ESI	ESI	ESI	ESI	ESI	ESI	ESI
TOP:	4	6	0	2	4	0	2	0	0
BOTTOM:	6	8	2	4	6	2	4	2	2
MATRIX:	SOIL	SOIL	SOIL	SOIL	SOIL	SOIL	SOIL	SOIL	SOIL
SAMPLE DATE:	12/15/93	12/15/93	12/01/93	12/01/93	12/01/93	11/17/93	11/17/93	12/06/93	12/06/93
SAMP ID:	SB13-6-3	SB13-6-4	SB17-1-1	SB17-1-2	SB17-1-3	SB26-1-1	SB26-1-2	SB4-1-1	SB4-1-10
METALS	VALUE (Q)	VALUE (Q)	VALUE (Q)	VALUE (Q)	VALUE (Q)	VALUE (Q)	VALUE (Q)	VALUE (Q)	VALUE (Q)
Aluminum	13500	10200	13700	18100	8700	5560	9040	14800	21000
Antimony	2.5 UJ	2.9 UJ	11.7 UJ	11.8 UJ	9 UJ	7.3 UJ	6.7 UJ	4.8 UJ	3.8 UJ
Arsenic	2.7	2.3	4.3	5.2	3.4	3.2	5.3	6.2	4.2
Barium	60.4	56.8	107	114	59.4	73.2	43.7	72	97.7
Beryllium	0.71	0.58 J	0.7 J	0.9 J	0.42 J	0.35 J	0.41 J	0.73 J	0.64 J
Cadmium	0.25 U	0.28 U	0.73 U	0.74 U	0.56 U	0.46 U	0.42 U	0.47 U	0.37 U
Calcium	31800	45200	2870	20900	72800	293000	47300	4280	2460
Chromium	23.5	17.8	17.6	25.1	13.9	10.3	15.7	23.2	27.9
Cobalt	15	11.3	9.9 J	13.3	8.8	5.9 J	9.5	11.3	5.9 J
Copper	27.4	14.5	46.4	26.9	20	9.7	14.3	14.1	15.1
Cyanide	0.53 U	0.51 U	0 NA	0 NA	0 NA	0.48 U	0.57 U	0.52 U	0.53 U
Iron	26900	20700	25100	29900	18800	8770	19100	27500	19500
Lead	11.6	11.7	266	11.4 J	7.5 J	6.33	8.5	17.7 J	9.8 J
Magnesium	6640	5220	3330	8490	18100	29100	9160	4270	4460
Manganese	508	556	547	487	391	309	551	615 JR	119 JR
Mercury	0.01 U	0.01 U	0.05 J	0.06 J	0.03 UJ	0.02 U	0.02 U	0.05 J	0.04 J
Nickel	41.9	33	19.1	42	25.2	31.6 R	23.9	27.8	25.1
Potassium	1120	1000	628 J	1560	1090	1710	901	1250	2490
Selenium	0.11 J	0.24 J	0.25 UJ	0.24 UJ	0.14 UJ	0.13 UJ	0.26 J	0.4 J	0.23 J
Silver	0.49 U	0.56 U	1.5 U	1.5 U	1.1 U	0.92 UJ	0.85 UJ	0.93 U	0.74 U
Sodium	116 J	141 J	46.2 J	74.6 J	137 J	192 J	108 J	43.8 U	39.2 J
Thallium	0.14 U	0.23 U	0.28 UJ	0.26 UJ	0.15 UJ	0.73 U	0.17 U	0.23 U	0.23 U
Vanadium	18.5	13.8	23.1	27	13.9	12.7	14.4	28.6	31
Zinc	64.7	39.3	93.4	80.2	57.1	283 R	90.6	79.6	72.1
U = compound was not detected									
J = the reported value is an estimated concentration									
UJ = the compound was not detected; the associated reporting limit is approximate									
R = the data was rejected in the data validating process									
NJ = compound was "tentatively identified" and the associated numerical value is approximate									

**TABLE B-1
SOIL BACKGROUND DATA
SEAD-59 AND SEAD-71 PHASE II RI REPORT
SENECA ARMY DEPOT ACTIVITY**

LOC ID:	SB4-1	SB4-1	TP57-11
QC CODE:	SA	SA	SA
STUDY ID:	ESI	ESI	ESI
TOP:	4	8	3
BOTTOM:	6	10	3
MATRIX:	SOIL	SOIL	SOIL
SAMPLE DATE:	12/06/93	12/06/93	11/08/93
SAMP ID:	SB4-1-2	SB4-1-3	TP57-11
METALS	VALUE (Q)	VALUE (Q)	VALUE (Q)
Aluminum	15300	19200	14600
Antimony	5 UJ	2.8 UJ	11.3 UJ
Arsenic	3.9	21.5	5.9
Barium	40.4 J	81.2	120
Beryllium	0.74 J	1	0.81 J
Cadmium	0.49 U	0.27 U	0.71 U
Calcium	30900	14400	22300
Chromium	27.6	32.7	20.1
Cobalt	16.5	29.1	8.8 J
Copper	62.8	21.6	21.7
Cyanide	0.53 U	0.47 U	0.54 U
Iron	34300	37900	24900
Lead	7.5 J	9.1 J	11.3
Magnesium	7130	8040	5360
Manganese	337 R	795 R	329
Mercury	0.04 J	0.04 J	0.04 J
Nickel	47.6	62.3	25.7
Potassium	1300	2030	1430
Selenium	0.09 U	0.14 U	0.46 J
Silver	0.98 U	0.64 J	1.4 UJ
Sodium	105 J	91.6 J	93 J
Thallium	0.16 U	0.24 U	0.17 U
Vanadium	22.2	29.3	27.8
Zinc	102	115	57.9
U = compound was not detected			
J = the reported value is an estimated concentration			
UJ = the compound was not detected; the associated reporting limit is approximate			
R = the data was rejected in the data validating process			
NJ = compound was "tentatively identified" and the associated numerical value is approximate			

**TABLE B-2
BACKGROUND GROUNDWATER DATA
SEAD-59 AND SEAD-71 PHASE II RI REPORT
SENECA ARMY DEPOT ACTIVITY**

STUDY ID:	RI PHASE1	3Q93	RI PHASE1	ESI	ESI
LOC ID:	MW-21	MW-35	MW-35	MW11-1	MW13-1
QC CODE:	SA	SA	SA	SA	SA
SAMP. DEPTH TOP:	NONE	NONE	NONE	NONE	NONE
SAMP. DEPTH BOT:	NONE	NONE	NONE	NONE	NONE
MATRIX:	GROUNDWATER	GROUNDWATER	GROUNDWATER	GROUNDWATER	GROUNDWATER
SAMP. DATE:	8-Jan-92	NONE	8-Jan-92	18-Jan-94	3-Feb-94
SAMP ID:	MW-21GW	MW35OB3Q93M	MW-35GW	MW11-1-1	MW13-1-1
PARAMETER	UNIT	VALUE Q	VALUE Q	VALUE Q	VALUE Q
METALS					
Aluminum	UG/L	1880 J	207	7550 J	53.7 J
Antimony	UG/L	55.9 U	16.8 U	55.5 U	21.4 U
Arsenic	UG/L	3.5 U	1 B	3.5 U	0.8 U
Barium	UG/L	47.5 J	97.3 B	103 J	25.2 J
Beryllium	UG/L	1.6 R	0.3 U	1.8 R	0.4 U
Cadmium	UG/L	2.9 U	2.4 U	2.9 U	2.1 U
Calcium	UG/L	94100	108000	94700	97500
Chromium	UG/L	6.2 U	3.3 U	15.3 R	2.6 U
Cobalt	UG/L	20 U	2.7 U	19.9 J	4.4 U
Copper	UG/L	14.5 U	2.1 U	14.4 U	3.1 U
Cyanide	UG/L	10 UJ	2.8 B	10 UJ	5 U
Iron	UG/L	2720	321	10500	41.4 J
Lead	UG/L	1.8 J	2.8 B	3.3	1.1 J
Magnesium	UG/L	12200	15600	14600	29700
Manganese	UG/L	232 J	23.4	557 J	278
Mercury	UG/L	0.15 R	0.1 U	0.18 R	0.04 U
Nickel	UG/L	16 U	8.3 U	15.9 U	4 U
Potassium	UG/L	3050 J	1400 B	4180 J	7100
Selenium	UG/L	1 U	1.2 B	1.1 J	0.7 U
Silver	UG/L	9.1 U	2.6 U	9 U	4.2 U
Sodium	UG/L	18400	13400	44100	4860 J
Thallium	UG/L	3.2 U	1.2 U	3.2 U	1.2 U
Vanadium	UG/L	30.6 U	3 U	30.3 U	3.7 U
Zinc	UG/L	15.1 R	72.7	58.2	21.4
U = compound was not detected					
J = the reported value is an estimated concentration					
UJ = the compound was not detected; the associated reporting limit is approximate					
R = the data was rejected in the data validating process					
NJ = compound was "tentatively identified" and the associated numerical value is approximate					

**TABLE B-2
BACKGROUND GROUNDWATER DATA
SEAD-59 AND SEAD-71 PHASE II RI REPORT
SENECA ARMY DEPOT ACTIVITY**

STUDY ID:	ESI	RI ROUND1	RI ROUND2	RI ROUND1	RI ROUND2
LOC ID:	MW13-4	MW16-1	MW16-1	MW17-1	MW17-1
QC CODE:	SA	SA	SA	SA	SA
SAMP. DETH TOP:	NONE	3.3	731.5	3.4	731.1
SAMP. DEPTH BOT:	NONE	5.3	728.4	7.4	727.1
MATRIX:	GROUNDWATER	GROUNDWATER	GROUNDWATER	GROUNDWATER	GROUNDWATER
SAMP. DATE:	4-Feb-94	27-Aug-96	7-Dec-96	29-Aug-96	11-Dec-96
SAMP ID:	MW13-4-1	16101	16152	16108	16171
PARAMETER	UNIT	VALUE Q	VALUE Q	VALUE Q	VALUE Q
METALS					
Aluminum	UG/L	5540	1850	143 U	90.4
Antimony	UG/L	31.5 J	2 U	3 U	2 U
Arsenic	UG/L	1.4 U	2.7 U	4.4 U	2.7 U
Barium	UG/L	71.2 J	74.2	48.2 U	85
Beryllium	UG/L	0.4 U	0.23	0.2 U	0.26
Cadmium	UG/L	2.1 U	0.3 U	0.6 U	0.3 U
Calcium	UG/L	182000	157000	116000	108000
Chromium	UG/L	9.9 J	2.7	1 U	1 U
Cobalt	UG/L	6.7 J	2.1	1.3 U	1.2 U
Copper	UG/L	3.3 J	4.9	1.9 U	3.1
Cyanide	UG/L	5 U	5 U	5 UJ	5 U
Iron	UG/L	8010	2400 J	296	119
Lead	UG/L	3.1	1.7 U	1.5 U	1.7 U
Magnesium	UG/L	44900	23300	17600	22600
Manganese	UG/L	299	210	64.2	21.3
Mercury	UG/L	0.04 U	0.1 U	0.1 U	0.1 U
Nickel	UG/L	17.5 J	4.7	2.5 U	1.8
Potassium	UG/L	4460 J	1670	998 U	472
Selenium	UG/L	1.2 J	2.4 U	4.7 UJ	2.4 U
Silver	UG/L	4.2 U	1.3 U	1.5 U	1.3 U
Sodium	UG/L	9340	8750	3870 U	9290
Thallium	UG/L	1.2 U	4.2 U	5.9 U	4.4
Vanadium	UG/L	8.8 J	3.3	1.6 U	1.2 U
Zinc	UG/L	138	15.6 R	5.8 U	2.5 R
U = compound was not detected					
J = the reported value is an estimated concentration					
UJ = the compound was not detected; the associated reporting limit is approximate					
R = the data was rejected in the data validating process					
NJ = compound was "tentatively identified" and the associated numerical value is approximate					

**TABLE B-2
BACKGROUND GROUNDWATER DATA
SEAD-59 AND SEAD-71 PHASE II RI REPORT
SENECA ARMY DEPOT ACTIVITY**

STUDY ID:	RI ROUND1	RI ROUND2	RI ROUND1	RI ROUND2	ESI	RI ROUND1	
LOC ID:	MW25-1	MW25-1	MW25-6	MW25-6	MW26-1	MW26-1	
QC CODE:	SA	SA	SA	SA	SA	SA	
SAMP. DETH TOP:	NONE	NONE	NONE	NONE	NONE	NONE	
SAMP. DEPTH BOT:	NONE	NONE	NONE	NONE	NONE	NONE	
MATRIX:	GROUNDWATER	GROUNDWATER	GROUNDWATER	GROUNDWATER	GROUNDWATER	GROUNDWATER	
SAMP. DATE:	22-Nov-95	10-Apr-96	21-Nov-95	31-Mar-96	21-Jan-94	13-Nov-95	
SAMP ID:	MW25-1	25001	MW25-6	25008	MW26-1-1	MW26-1	
PARAMETER	UNIT	VALUE	Q	VALUE	Q	VALUE	Q
METALS							
Aluminum	UG/L	18		34.5	U	162	
Antimony	UG/L	2.2	U	1.4		2.2	U
Arsenic	UG/L	2.1	U	4	U	2.1	U
Barium	UG/L	77.1		71.2		85.6	
Beryllium	UG/L	0.27	U	0.1	U	0.27	U
Cadmium	UG/L	0.3	U	0.3	U	0.3	U
Calcium	UG/L	128000		122000		133000	
Chromium	UG/L	0.68		0.7	U	2.2	
Cobalt	UG/L	0.99	U	0.9	U	1.3	
Copper	UG/L	2		1	U	0.99	
Cyanide	UG/L	5	U	5	U	5	UJ
Iron	UG/L	27.3		21.7	U	308	
Lead	UG/L	3.4		1.9	U	4.4	
Magnesium	UG/L	23100		22800		35900	
Manganese	UG/L	31.2		21.8		56	
Mercury	UG/L	0.02	U	0.2	U	0.02	U
Nickel	UG/L	0.99	U	1.6	U	2.6	
Potassium	UG/L	1030		861	J	1840	J
Selenium	UG/L	3.7	U	3.4	U	3.7	U
Silver	UG/L	0.8	U	1.3	U	0.8	U
Sodium	UG/L	64700	J	53100		20400	J
Thallium	UG/L	3	U	4.7	U	3	U
Vanadium	UG/L	1.1	U	1.1	U	1.4	
Zinc	UG/L	6.3		1.7		7.5	
U = compound was not detected							
J = the reported value is an estimated concentration							
UJ = the compound was not detected; the associated reporting limit is approximate							
R = the data was rejected in the data validating process							
NJ = compound was "tentatively identified" and the associated numerical value is approximate							

**TABLE B-2
BACKGROUND GROUNDWATER DATA
SEAD-59 AND SEAD-71 PHASE II RI REPORT
SENECA ARMY DEPOT ACTIVITY**

STUDY ID:	RI ROUND2	ESI	ESI	ESI	ESI	ESI	ESI
LOC ID:	MW26-1	MW4-1	MW44A-1	MW44B-1	MW5-1	MW57-1	
QC CODE:	SA	SA	SA	SA	SA	SA	
SAMP. DETH TOP:	NONE	NONE	NONE	NONE	NONE	NONE	
SAMP. DEPTH BOT:	NONE	NONE	NONE	NONE	NONE	NONE	
MATRIX:	GROUNDWATER	GROUNDWATER	GROUNDWATER	GROUNDWATER	GROUNDWATER	GROUNDWATER	
SAMP. DATE:	11-Apr-96	21-Jan-94	12-Jul-94	12-Jul-94	11-Jul-94	3-Feb-94	
SAMP ID:	26001	MW4-1-1	MW44A-1-1	MW44B-1-1	MW5-1-1	MW57-1-1	
PARAMETER	UNIT	VALUE	Q	VALUE	Q	VALUE	Q
METALS							
Aluminum	UG/L	38.7		41.9	U	69	J
Antimony	UG/L	1.4		21.6	U	1.3	U
Arsenic	UG/L	4	U	2.2	J	2	U
Barium	UG/L	29.9		19.6	J	102	J
Beryllium	UG/L	0.1	U	0.4	U	0.1	U
Cadmium	UG/L	0.3	U	2.1	U	0.2	U
Calcium	UG/L	110000		137000		92200	
Chromium	UG/L	0.73		2.6	U	0.4	U
Cobalt	UG/L	0.9	U	4.6	J	0.5	U
Copper	UG/L	1	U	3.1	U	0.5	U
Cyanide	UG/L	5	U	5	U	5	U
Iron	UG/L	58.4	J	332		114	J
Lead	UG/L	1.9	U	0.5	U	0.9	U
Magnesium	UG/L	15500		57600		19000	
Manganese	UG/L	2.5		346		18.2	
Mercury	UG/L	0.2	U	0.04	U	0.04	U
Nickel	UG/L	1.6	U	4	U	0.7	U
Potassium	UG/L	3860	J	7380		1050	J
Selenium	UG/L	3.4	U	2.1	J	2.7	U
Silver	UG/L	1.3	U	4.2	U	0.5	U
Sodium	UG/L	34800		11700		2310	J
Thallium	UG/L	4.7	U	1.2	U	1.9	U
Vanadium	UG/L	1.1	U	3.7	U	0.5	U
Zinc	UG/L	3.1	J	19.1	J	3.8	J
U = compound was not detected							
J = the reported value is an estimated concentration							
UJ = the compound was not detected; the associated reporting limit is approximate							
R = the data was rejected in the data validating process							
NJ = compound was "tentatively identified" and the associated numerical value is approximate							

**TABLE B-2
BACKGROUND GROUNDWATER DATA
SEAD-59 AND SEAD-71 PHASE II RI REPORT
SENECA ARMY DEPOT ACTIVITY**

STUDY ID:	ESI	ESI	ESI	ESI	ESI	ESI	RI PHASE2						
LOC ID:	MW58-1	MW64A-1	MW64B-1	MW64C-9	MW64D-1	PT-10							
QC CODE:	SA	SA	SA	SA	SA	SA							
SAMP. DETH TOP:	NONE	NONE	NONE	NONE	NONE	NONE							
SAMP. DEPTH BOT:	NONE	NONE	NONE	NONE	NONE	NONE							
MATRIX:	GROUNDWATER	GROUNDWATER	GROUNDWATER	GROUNDWATER	GROUNDWATER	GROUNDWATER							
SAMP. DATE:	11-Jul-94	19-Jul-94	10-Jul-94	10-Jul-94	8-Jul-94	23-Jun-93							
SAMP ID:	MW58-1-1	MW64A-1-1G	MW64B-1-1G	MW64C-9-1	MW64D-1-1	PT10GW1							
PARAMETER	UNIT	VALUE	Q	VALUE	Q	VALUE	Q	VALUE	Q	VALUE	Q		
METALS													
Aluminum	UG/L	440		398		198	J	38.2	J	177	J	72	U
Antimony	UG/L	1.3	U	1.3	U	1.3	U	1.3	U	1.3	U	49.5	UJ
Arsenic	UG/L	2	U	2	U	2	U	2	U	2	U	1.4	UJ
Barium	UG/L	71.9	J	42	J	104	J	20.4	J	88.6	J	193	J
Beryllium	UG/L	0.1	U	0.1	U	0.1	U	0.1	U	0.1	U	0.89	U
Cadmium	UG/L	0.2	U	0.2	U	0.2	U	0.2	U	0.2	U	2.8	U
Calcium	UG/L	113000		109000		138000		121000		142000		79100	
Chromium	UG/L	0.82	J	0.49	J	0.41	J	0.4	U	0.4	U	2.7	UJ
Cobalt	UG/L	0.64	J	0.5	U	1.1	J	0.5	U	0.69	J	5.4	U
Copper	UG/L	1.5	J	0.61	J	1	J	0.55	J	0.5	U	4.7	U
Cyanide	UG/L	5	U	5	U	5	U	5	U	5	U	10	UJ
Iron	UG/L	678		773	J	400		681		440		85.6	J
Lead	UG/L	0.89	U	0.89	U	0.9	U	0.9	U	0.9	U	0.79	U
Magnesium	UG/L	17300		16800		45600		49400		14800		34200	
Manganese	UG/L	84		28.3		98.9		96		223		124	
Mercury	UG/L	0.04	U	0.04	J	0.04	U	0.04	U	0.04	U	0.09	UJ
Nickel	UG/L	1.6	J	1	J	1.4	J	1.2	J	1.4	J	7.4	UJ
Potassium	UG/L	1460	J	1790	J	4780	J	1670	J	3340	J	2870	J
Selenium	UG/L	2.7	U	2.7	U	2.7	U	2.7	U	2.7	U	0.99	UJ
Silver	UG/L	0.5	U	0.5	U	0.5	U	0.5	U	0.5	U	5.4	U
Sodium	UG/L	4180	J	2180	J	8140		6420		12300		41100	
Thallium	UG/L	1.9	U	1.9	U	1.9	U	1.9	U	2.2	J		
Vanadium	UG/L	0.81	J	1.3	J	0.73	J	0.61	J	0.69	J	6.7	UJ
Zinc	UG/L	7.1	J	3.9	J	3.9	J	3.9	J	3.8	J	8.8	J
U = compound was not detected													
J = the reported value is an estimated concentration													
UJ = the compound was not detected; the associated reporting limit is approximate													
R = the data was rejected in the data validating process													
NJ = compound was "tentatively identified" and the associated numerical value is approximate													

Appendix C

SEAD-59 Human Health Risk Assessment Calculation Tables

- C-1 Calculation of Intake and Risk from the Ingestion of Soil – RME
- C-2 Calculation of Intake and Risk from the Ingestion of Soil – CT
- C-3 Calculation of Absorbed Dose and Risk from Dermal Contact to Soil – RME
- C-4 Calculation of Absorbed Dose and Risk from Dermal Contact to Soil – CT
- C-5 Calculation of intake and Risk from Inhalation of Dust in Ambient Air – RME
- C-6 Calculation of intake and Risk from Inhalation of Dust in Ambient Air – CT
- C-7 Calculation of Absorbed Dose and Risk from Dermal Contact to Groundwater – RME
- C-8 Calculation of Absorbed Dose and Risk from Dermal Contact to Groundwater – CT
- C-9 Calculation of Intake and Risk from the Intake of Groundwater – RME
- C-10 Calculation of Intake and Risk from the Intake of Groundwater - CT

**TABLE C-1
CALCULATION OF INTAKE AND RISK FROM THE INGESTION OF SOIL
REASONABLE MAXIMUM EXPOSURE (RME) - SEAD-59 SOIL
SEAD-59 AND SEAD-71 PHASE II RI
Seneca Army Depot Activity**

Equation for Intake (mg/kg-day) =	$\frac{EPC \times IR \times CF \times FI \times EF \times ED \times B}{BW \times AT}$	Equation for Hazard Quotient = Chronic Daily Intake (Nc)/Reference Dose
Variables (Assumptions for Each Receptor are Listed at the Bottom):		Equation for Cancer Risk = Chronic Daily Intake (Car) x Slope Factor
EPC = Exposure Point Concentration in Soil, mg/kg		
IR = Ingestion Rate		EF = Exposure Frequency
CF = Conversion Factor	B = Bioavailability	ED = Exposure Duration
FI = Fraction Ingested		BW = Bodyweight
		AT = Averaging Time

Analyte	Oral RfD (mg/kg-day)	Carc. Slope Oral (mg/kg-day) ⁻¹	Bioavailability (unitless)	EPC Surface Soil (mg/kg)	EPC from Total Soils (mg/kg)	Industrial Worker			Construction Worker			Child Trespasser					
						Intake (mg/kg-day)		Hazard Quotient	Cancer Risk	Intake (mg/kg-day)		Hazard Quotient	Cancer Risk	Intake (mg/kg-day)		Hazard Quotient	Cancer Risk
						(Nc)	(Car)			(Nc)	(Car)			(Nc)	(Car)		
Benzo(a)anthracene	N/A	7.3E-01	0.29	1.4E+00	1.4E+00		1.39E-07		1E-07		1.87E-08		1E-08		1.74E-08		1E-08
Benzo(a)pyrene	N/A	7.3E+00	0.29	1.4E+00	1.4E+00		1.42E-07		1E-06		1.87E-08		1E-07		1.78E-08		1E-07
Benzo(b)fluoranthene	N/A	7.3E-01	0.29	1.3E+00	1.2E+00		1.27E-07		9E-08		1.61E-08		1E-08		1.59E-08		1E-08
Benzo(k)fluoranthene	N/A	7.3E-02	0.29	1.1E+00	1.2E+00		1.11E-07		8E-09		1.61E-08		1E-09		1.40E-08		1E-09
Chrysene	N/A	7.3E-03	0.29	1.4E+00	1.4E+00		1.42E-07		1E-09		1.87E-08		1E-10		1.78E-08		1E-10
Dibenz(a,h)anthracene	N/A	7.3E+00	0.29	3.5E-01	4.0E-01		3.55E-08		3E-07		5.35E-09		4E-08		4.45E-09		3E-08
Indeno(1,2,3-cd)pyrene	N/A	7.3E-01	0.29	8.8E-01	8.7E-01		8.88E-08		6E-08		1.16E-08		8E-09		1.11E-08		8E-09
4,4'-DDE	N/A	3.4E-01	1	1.3E-01	1.2E-01		4.54E-08		2E-08		5.54E-09		2E-09		5.70E-09		2E-09
4,4'-DDT	5.E-04	3.4E-01	1	1.8E-01	1.7E-01	1.76E-07	6.29E-08	4E-04	2E-08	5.49E-07	7.84E-09	1E-03	3E-09	9.21E-08	7.89E-09	2E-04	3E-09
Antimony	4.E-04	N/A	1	1.4E+01	1.3E+01	1.36E-05		3E-02		4.20E-05		1E-01		7.11E-06		2E-02	
Arsenic	3.E-04	1.5E+00	1	5.8E+00	5.7E+00	5.63E-06	2.01E-06	2E-02	3E-06	1.84E-05	2.63E-07	6E-02	4E-07	2.94E-06	2.52E-07	1E-02	4E-07
Iron	3.E-01	N/A	1	2.2E+04	2.2E+04	2.14E-02		7E-02		7.02E-02		2E-01		1.12E-02		4E-02	
Total Hazard Quotient and Cancer Risk:								1E-01	5E-06			4E-01	6E-07			6E-02	6E-07
						Assumptions for Industrial Worker			Assumptions for Construction Worker			Assumptions for Child Trespasser					
						CF =	1E-06 kg/mg			CF =	1E-06 kg/mg			CF =	1E-06 kg/mg		
						EPC=	EPC Surface Only			EPC=	EPC Surface and Subsurface			EPC=	EPC Surface Only		
						BW =	70 kg			BW =	70 kg			BW =	15 kg		
						IR =	100 mg/day			IR =	330 mg/day			IR =	200 mg/day		
						FI =	1 unitless			FI =	1 unitless			FI =	1 unitless		
						EF =	250 days/year			EF =	250 days/year			EF =	14 days/year		
						ED =	25 years			ED =	1 years			ED =	6 years		
						AT (Nc) =	9,125 days			AT (Nc) =	365 days			AT (Nc) =	2,190 days		
						AT (Car) =	25,550 days			AT (Car) =	25,550 days			AT (Car) =	25,550 days		

Note: Cells in this table were intentionally left blank due to a lack of toxicity data.
NA= Information not available.

**TABLE C-2
CALCULATION OF INTAKE AND RISK FROM THE INGESTION OF SOIL
CENTRAL TENDENCY (CT) - SEAD-59 SOIL
SEAD-59 AND SEAD-71 PHASE II RI
Seneca Army Depot Activity**

Equation for Intake (mg/kg-day) =	$\frac{EPC \times IR \times CF \times FI \times EF \times ED \times B}{BW \times AT}$	Equation for Hazard Quotient = Chronic Daily Intake (Nc)/Reference Dose
Variables (Assumptions for Each Receptor are Listed at the Bottom):		Equation for Cancer Risk = Chronic Daily Intake (Car) x Slope Factor
EPC = Exposure Point Concentration in Soil, mg/kg	EF = Exposure Frequency	
IR = Ingestion Rate	ED = Exposure Duration	
CF = Conversion Factor	BW = Bodyweight	
FI = Fraction Ingested	AT = Averaging Time	
	B = Bioavailability	

Analyte	Oral RfD (mg/kg-day)	Carc. Slope Oral (mg/kg-day) ⁻¹	Bioavailability (unitless)	EPC Surface Soil (mg/kg)	EPC from Total Soils (mg/kg)	Industrial Worker			Construction Worker			Child Trespasser					
						Intake (mg/kg-day)		Hazard Quotient	Cancer Risk	Intake (mg/kg-day)		Hazard Quotient	Cancer Risk	Intake (mg/kg-day)		Hazard Quotient	Cancer Risk
						(Nc)	(Car)			(Nc)	(Car)			(Nc)	(Car)		
Benzo(a)anthracene	N/A	7.3E-01	0.29	1.4E+00	1.4E+00		2.19E-08	2E-08		4.97E-09	4E-09		8.71E-09	6E-09			
Benzo(a)pyrene	N/A	7.3E+00	0.29	1.4E+00	1.4E+00		2.24E-08	2E-07		4.97E-09	4E-08		8.90E-09	6E-08			
Benzo(b)fluoranthene	N/A	7.3E-01	0.29	1.3E+00	1.2E+00		2.00E-08	1E-08		4.26E-09	3E-09		7.95E-09	6E-09			
Benzo(k)fluoranthene	N/A	7.3E-02	0.29	1.1E+00	1.2E+00		1.76E-08	1E-09		4.26E-09	3E-10		6.99E-09	5E-10			
Chrysene	N/A	7.3E-03	0.29	1.4E+00	1.4E+00		2.24E-08	2E-10		4.97E-09	4E-11		8.90E-09	6E-11			
Dibenz(a,h)anthracene	N/A	7.3E+00	0.29	3.5E-01	4.0E-01		5.59E-09	4E-08		1.42E-09	1E-08		2.22E-09	2E-08			
Indeno(1,2,3-cd)pyrene	N/A	7.3E-01	0.29	8.8E-01	8.7E-01		1.40E-08	1E-08		3.09E-09	2E-09		5.57E-09	4E-09			
4,4'-DDE	N/A	3.4E-01	1	1.3E-01	1.2E-01		7.16E-09	2E-09		1.47E-09	5E-10		2.85E-09	1E-09			
4,4'-DDT	5E-04	3.4E-01	1	1.8E-01	1.7E-01	7.71E-08	9.92E-09	2E-04	3E-09	1.46E-07	2.08E-09	3E-04	7E-10	4.60E-08	3.95E-09	9E-05	1E-09
Antimony	4E-04	N/A	1	1.4E+01	1.3E+01	5.96E-06		1E-02		1.11E-05		3E-02		3.55E-06		9E-03	
Arsenic	3E-04	1.5E+00	1	5.8E+00	5.7E+00	2.46E-06	3.17E-07	8E-03	5E-07	4.89E-06	6.98E-08	2E-02	1E-07	1.47E-06	1.26E-07	5E-03	2E-07
Iron	3E-01	N/A	1	2.2E+04	2.2E+04	9.36E-03		3E-02		1.86E-02		6E-02		5.59E-03		2E-02	
Total Hazard Quotient and Cancer Risk:								5E-02	7E-07			1E-01	2E-07			3E-02	3E-07
						Assumptions for Industrial Worker			Assumptions for Construction Worker			Assumptions for Child Trespasser					
						CF =	1E-06 kg/mg	CF =	1E-06 kg/mg	CF =	1E-06 kg/mg	CF =	1E-06 kg/mg	CF =	1E-06 kg/mg		
						EPC=	EPC Surface Only	EPC=	EPC Surface and Subsurface	EPC=	EPC Surface Only	EPC=	EPC Surface Only	EPC=	EPC Surface Only		
						BW =	70 kg	BW =	70 kg	BW =	15 kg	BW =	15 kg	BW =	15 kg		
						IR =	50 mg/day	IR =	100 mg/day	IR =	100 mg/day	IR =	100 mg/day	IR =	100 mg/day		
						FI =	1 unitless	FI =	1 unitless	FI =	1 unitless	FI =	1 unitless	FI =	1 unitless		
						EF =	219 days/year	EF =	219 days/year	EF =	14 days/year	EF =	14 days/year	EF =	14 days/year		
						ED =	9 years	ED =	1 years	ED =	6 years	ED =	6 years	ED =	6 years		
						AT (Nc) =	3,285 days	AT (Nc) =	365 days	AT (Nc) =	2,190 days	AT (Nc) =	2,190 days	AT (Nc) =	2,190 days		
						AT (Car) =	25,550 days	AT (Car) =	25,550 days	AT (Car) =	25,550 days	AT (Car) =	25,550 days	AT (Car) =	25,550 days		

Note: Cells in this table were intentionally left blank due to a lack of toxicity data.

NA= Information not available.

**TABLE C-3
CALCULATION OF ABSORBED DOSE AND RISK FROM DERMAL CONTACT TO SOIL
REASONABLE MAXIMUM EXPOSURE (RME) - SEAD-59 SOIL
SEAD-59 AND SEAD-71 PHASE II RI
Seneca Army Depot Activity**

Equation for Intake (mg/kg-day) =	$\frac{EPC \times CF \times SA \times AF \times ABS \times EV \times EF \times ED}{BW \times AT}$	Equation for Hazard Quotient = Chronic Daily Intake (Nc)/Reference Dose Equation for Cancer Risk = Chronic Daily Intake (Car) x Slope Factor
Variables (Assumptions for Each Receptor are Listed at the Bottom):		
EPC = Exposure Point Concentration in Soil, mg/kg	EV = Event Frequency	
CF = Conversion Factor	EF = Exposure Frequency	
SA = Surface Area Contact	ED = Exposure Duration	
AF = Adherence Factor	BW = Bodyweight	
ABS = Absorption Factor	AT = Averaging Time	

Analyte	Dermal RfD (mg/kg-day)	Carc. Slope Dermal (mg/kg-day)-1	Absorption Factor* (unitless)	EPC Surface Soil (mg/kg)	EPC from Total Soils (mg/kg)	Industrial Worker			Construction Worker			Child Trespasser					
						Absorbed Dose (mg/kg-day)		Hazard Quotient	Cancer Risk	Absorbed Dose (mg/kg-day)		Hazard Quotient	Cancer Risk	Absorbed Dose (mg/kg-day)		Hazard Quotient	Cancer Risk
						(Nc)	(Car)			(Nc)	(Car)			(Nc)	(Car)		
Benzo(a)anthracene	N/A	7.3E-01	1.3E-01	1.4E+00	1.4E+00		4.11E-07		3E-07		2.52E-08		2E-08		2.19E-08		1.60E-08
Benzo(a)pyrene	N/A	7.3E+00	1.3E-01	1.4E+00	1.4E+00		4.20E-07		3E-06		2.52E-08		2E-07		2.23E-08		1.63E-07
Benzo(b)fluoranthene	N/A	7.3E-01	1.3E-01	1.3E+00	1.2E+00		3.75E-07		3E-07		2.16E-08		2E-08		1.99E-08		1.46E-08
Benzo(k)fluoranthene	N/A	7.3E-02	1.3E-01	1.1E+00	1.2E+00		3.30E-07		2E-08		2.16E-08		2E-09		1.76E-08		1.28E-09
Chrysene	N/A	7.3E-03	1.3E-01	1.4E+00	1.4E+00		4.20E-07		3E-09		2.52E-08		2E-10		2.23E-08		1.63E-10
Dibenz(a,h)anthracene	N/A	7.3E+00	1.3E-01	3.5E-01	4.0E-01		1.05E-07		8E-07		7.20E-09		5E-08		5.58E-09		4.08E-08
Indeno(1,2,3-cd)pyrene	N/A	7.3E-01	1.3E-01	8.8E-01	8.7E-01		2.63E-07		2E-07		1.57E-08		1E-08		1.40E-08		1.02E-08
4,4'-DDE	N/A	3.4E-01	3E-02	1.3E-01	1.2E-01		8.99E-09		3E-09		4.98E-10		2E-10		4.79E-10		1.63E-10
4,4'-DDT	5.E-04	3.4E-01	3E-02	1.8E-01	1.7E-01	3.49E-08	1.25E-08	7E-05	4E-09	4.94E-08	7.06E-10	1E-04	2E-10	7.73E-09	6.63E-10	1.55E-05	2.25E-10
Antimony	6.E-05	N/A	1E-03	1.4E+01	1.3E+01	8.98E-08		1E-03		1.26E-07		2E-03		1.99E-08		3.32E-04	
Arsenic	3.E-04	1.5E+00	3E-02	5.8E+00	5.7E+00	1.11E-06	3.98E-07	4E-03	6E-07	1.66E-06	2.37E-08	6E-03	4E-08	2.47E-07	2.12E-08	8.23E-04	3.18E-08
Iron	3.E-01	N/A	1E-03	2.2E+04	2.2E+04	1.41E-04		5E-04		2.11E-04		7E-04		3.13E-05		1.04E-04	
Total Hazard Quotient and Cancer Risk:								6E-03	5E-06			8E-03	3E-07			1E-03	3E-07
						Assumptions for Industrial Worker			Assumptions for Construction Worker			Assumptions for Child Trespasser					
						CF =	1E-06 kg/mg			CF =	1E-06 kg/mg			CF =	1E-06 kg/mg		
						CS =	EPC Surface Only			EPC =	EPC Surface and Subsurface			EPC =	EPC Surface Only		
						BW =	70 kg			BW =	70 kg			BW =	15 kg		
						SA =	3,300 cm ²			SA =	3,300 cm ²			SA =	2,800 cm ²		
						AF =	0.2 mg/cm ² -event			AF =	0.3 mg/cm ² -event			AF =	0.2 mg/cm ² -event		
						EV =	1 event/day			EV =	1 event/day			EV =	1 event/day		
						EF =	250 days/year			EF =	250 days/year			EF =	14 days/year		
						ED =	25 years			ED =	1 years			ED =	6 years		
						AT (Nc) =	9,125 days			AT (Nc) =	365 days			AT (Nc) =	2,190 days		
						AT (Car) =	25,550 days			AT (Car) =	25,550 days			AT (Car) =	25,550 days		

Note: Cells in this table were intentionally left blank due to a lack of toxicity data.

N/A= Information not available.

* Absorption factors from Exhibit 3-4 of USEPA (2004) Supplemental Guidance for Dermal Risk Assessment, Part E of Risk Assessment Guidance for Superfund, Human Health Evaluation Manual (Volume I).

Absorption factors for antimony and iron were assumed to be 0.001 in accordance with the USEPA Region 4 (2000)

Supplemental Guidance to RAGS: Region 4 Bulletins, Human Health Risk Assessment Bulletins (<http://www.epa.gov/region4/waste/ots/healthbul.htm>).

**TABLE C-4
CALCULATION OF ABSORBED DOSE AND RISK FROM DERMAL CONTACT TO SOIL
CENTRAL TENDENCY (CT) - SEAD-59 SOIL
SEAD-59 AND SEAD-71 PHASE II RI
Seneca Army Depot Activity**

Equation for Intake (mg/kg-day) =	$\frac{EPC \times CF \times SA \times AF \times ABS \times EV \times EF \times ED}{BW \times AT}$	Equation for Hazard Quotient = Chronic Daily Intake (Nc)/Reference Dose Equation for Cancer Risk = Chronic Daily Intake (Car) x Slope Factor
Variables (Assumptions for Each Receptor are Listed at the Bottom):		
EPC = Exposure Point Concentration in Soil, mg/kg CF = Conversion Factor SA = Surface Area Contact AF = Adherence Factor ABS = Absorption Factor	EV = Event Frequency EF = Exposure Frequency ED = Exposure Duration BW = Bodyweight AT = Averaging Time	

Analyte	Dermal RfD (mg/kg-day)	Carc. Slope Dermal (mg/kg-day) ⁻¹	Absorption Factor* (unitless)	EPC Surface Soil (mg/kg)	EPC from Total Soils (mg/kg)	Industrial Worker			Construction Worker			Child Trespasser					
						Absorbed Dose (mg/kg-day)		Hazard Quotient	Cancer Risk	Absorbed Dose (mg/kg-day)		Hazard Quotient	Cancer Risk	Absorbed Dose (mg/kg-day)		Hazard Quotient	Cancer Risk
						(Nc)	(Car)			(Nc)	(Car)			(Nc)	(Car)		
Benzo(a)anthracene	N/A	7.3E-01	1.3E-01	1.4E+00	1.4E+00		1.30E-08		9E-09		2.21E-08		2E-08		4.37E-09		3.19E-09
Benzo(a)pyrene	N/A	7.3E+00	1.3E-01	1.4E+00	1.4E+00		1.32E-08		1E-07		2.21E-08		2E-07		4.47E-09		3.26E-08
Benzo(b)fluoranthene	N/A	7.3E-01	1.3E-01	1.3E+00	1.2E+00		1.18E-08		9E-09		1.89E-08		1E-08		3.99E-09		2.91E-09
Benzo(k)fluoranthene	N/A	7.3E-02	1.3E-01	1.1E+00	1.2E+00		1.04E-08		8E-10		1.89E-08		1E-09		3.51E-09		2.56E-10
Chrysene	N/A	7.3E-03	1.3E-01	1.4E+00	1.4E+00		1.32E-08		1E-10		2.21E-08		2E-10		4.47E-09		3.26E-11
Dibenz(a,h)anthracene	N/A	7.3E+00	1.3E-01	3.5E-01	4.0E-01		3.31E-09		2E-08		6.30E-09		5E-08		1.12E-09		8.15E-09
Indeno(1,2,3-cd)pyrene	N/A	7.3E-01	1.3E-01	8.8E-01	8.7E-01		8.28E-09		6E-09		1.37E-08		1E-08		2.80E-09		2.04E-09
4,4'-DDE	N/A	3.4E-01	3E-02	1.3E-01	1.2E-01		2.84E-10		1E-10		4.36E-10		1E-10		9.57E-11		3.26E-11
4,4'-DDT	5.E-04	3.4E-01	3E-02	1.8E-01	1.7E-01	3.05E-09	3.93E-10	6E-06	1E-10	4.33E-08	6.18E-10	9E-05	2E-10	1.55E-09	1.33E-10	3.09E-06	4.51E-11
Antimony	6.E-05	N/A	1E-03	1.4E+01	1.3E+01	7.86E-09		1E-04		1.10E-07		2E-03		3.98E-09		6.63E-05	
Arsenic	3.E-04	1.5E+00	3E-02	5.8E+00	5.7E+00	9.76E-08	1.25E-08	3E-04	2E-08	1.45E-06	2.07E-08	5E-03	3E-08	4.94E-08	4.23E-09	1.65E-04	6.35E-09
Iron	3.E-01	N/A	1E-03	2.2E+04	2.2E+04	1.24E-05		4E-05		1.85E-04		6E-04		6.26E-06		2.09E-05	
Total Hazard Quotient and Cancer Risk:								5E-04	2E-07			7E-03	3E-07			3E-04	6E-08
						Assumptions for Industrial Worker			Assumptions for Construction Worker			Assumptions for Child Trespasser					
						CF =	1E-06 kg/mg			CF =	1E-06 kg/mg			CF =	1E-06 kg/mg		
						CS =	EPC Surface Only			EPC =	EPC Surface and Subsurface			EPC =	EPC Surface Only		
						BW =	70 kg			BW =	70 kg			BW =	15 kg		
						SA =	3,300 cm ²			SA =	3,300 cm ²			SA =	2,800 cm ²		
						AF =	0.02 mg/cm ² -event			AF =	0.3 mg/cm ² -event			AF =	0.04 mg/cm ² -event		
						EV =	1 event/day			EV =	1 event/day			EV =	1 event/day		
						EF =	219 days/year			EF =	219 days/year			EF =	14 days/year		
						ED =	9 years			ED =	1 years			ED =	6 years		
						AT (Nc) =	3,285 days			AT (Nc) =	365 days			AT (Nc) =	2,190 days		
						AT (Car) =	25,550 days			AT (Car) =	25,550 days			AT (Car) =	25,550 days		

Note: Cells in this table were intentionally left blank due to a lack of toxicity data.

N/A= Information not available.

* Absorption factors from Exhibit 3-4 of USEPA (2004) Supplemental Guidance for Dermal Risk Assessment, Part E of Risk Assessment Guidance for Superfund, Human Health Evaluation Manual (Volume I).

Absorption factors for antimony and iron were assumed to be 0.001 in accordance with the USEPA Region 4 (2000)

Supplemental Guidance to RAGS: Region 4 Bulletins, Human Health Risk Assessment Bulletins (<http://www.epa.gov/region4/waste/ots/healthul.htm>).

**TABLE C-6
CALCULATION OF INTAKE AND RISK FROM INHALATION OF DUST IN AMBIENT AIR
CENTRAL TENDENCY EXPOSURE (CT) - SEAD-59 SOIL
SEAD-59 AND SEAD-71 PHASE II RI
Seneca Army Depot Activity**

Equation for Intake (mg/kg-day) = $\frac{EPC \times IR \times EF \times ED}{BW \times AT}$	Equation for Hazard Quotient = Chronic Daily Intake (Nc)/Reference Dose
Variables (Assumptions for Each Receptor are Listed at the Bottom): EPC = EPC in Air, mg/m3 IR = Inhalation Rate EF = Exposure Frequency	Equation for Cancer Risk = Chronic Daily Intake (Car) x Slope Factor
ED = Exposure Duration BW = Bodyweight AT = Averaging Time	

Analyte	Inhalation RID (mg/kg-day)	Carc. Slope Inhalation (mg/kg-day)-1	Air EPC from Surface Soil (mg/m3)	Air EPC from Total Soils (mg/m3)	Industrial Worker			Construction Worker			Child Trespasser					
					Intake (mg/kg-day)		Hazard Quotient	Cancer Risk	Intake (mg/kg-day)		Hazard Quotient	Cancer Risk	Intake (mg/kg-day)		Hazard Quotient	Cancer Risk
					(Nc)	(Car)			(Nc)	(Car)			(Nc)	(Car)		
Benzo(a)anthracene	N/A	N/A	2.3E-08	1.3E-06												
Benzo(a)pyrene	N/A	3.1E+00	2.4E-08	1.3E-06		2.73E-10		8E-10		3.27E-09		1E-08		6.26E-11		2E-10
Benzo(b)fluoranthene	N/A	N/A	2.1E-08	1.1E-06												
Benzo(k)fluoranthene	N/A	N/A	1.9E-08	1.1E-06												
Chrysene	N/A	N/A	2.4E-08	1.3E-06												
Dibenz(a,h)anthracene	N/A	N/A	6.0E-09	3.8E-07												
Indeno(1,2,3-cd)pyrene	N/A	N/A	1.5E-08	8.3E-07												
4,4'-DDE	N/A	N/A	2.2E-09	1.1E-07												
4,4'-DDT	N/A	3.4E-01	3.1E-09	1.6E-07		3.51E-11		1E-11		3.97E-10		1E-10		8.05E-12		3E-12
Antimony	N/A	N/A	2.4E-07	1.2E-05												
Arsenic	N/A	1.5E+01	9.8E-08	5.4E-06		1.12E-09		2E-08		1.33E-08		2E-07		2.57E-10		4E-09
Iron	N/A	N/A	3.7E-04	2.1E-02												
Total Hazard Quotient and Cancer Risk:								2E-08				2E-07				4E-09
					Assumptions for Industrial Worker			Assumptions for Construction Worker			Assumptions for Child Trespasser					
					CA =	EPC Surface Only		CA =	EPC Surface and Sub-Surface		CA =	EPC Surface Only				
					BW =	70 kg		BW =	70 kg		BW =	15 kg				
					IR =	10.4 m3/day		IR =	20 m3/day		IR =	12 m3/day				
					EF =	219 days/year		EF =	219 days/year		EF =	14 days/year				
					ED =	9 years		ED =	1 year		ED =	6 years				
					AT (Nc) =	3,285 days		AT (Nc) =	365 days		AT (Nc) =	2,190 days				
					AT (Car) =	25,550 days		AT (Car) =	25,550 days		AT (Car) =	25,550 days				

Note: Cells in this table were intentionally left blank due to a lack of toxicity data.
NA= Information not available.

**TABLE C-7
CALCULATION OF ABSORBED DOSE AND RISK FROM DERMAL CONTACT TO GROUNDWATER
REASONABLE MAXIMUM EXPOSURE (RME) - SEAD-59
SEAD-59 AND SEAD-71 PHASE II RI
Seneca Army Depot Activity**

Equation for Dermal (mg/kg-day) = $\frac{DA \times SA \times EF \times ED \times EV}{BW \times AT}$	Equation for Absorbed Dose per Event (DA): For inorganics: $DA = K_p \times EPC \times t_{event} \times CF$	
Variables (Assumptions for Each Receptor are Listed at the Bottom): DA = Absorbed Dose per Event, mg/cm ² -event SA = Surface Area Contact EF = Exposure Frequency EV = Event Frequency	K_p = Permeability Coefficient, cm/hr EPC = EPC in Groundwater, mg/L CF = Conversion Factor, 10 ⁻³ L/cm ³	Equation for Hazard Quotient = Chronic Daily Intake (Nc)/Reference Dose Equation for Cancer Risk = Chronic Daily Intake (Car) x Slope Factor
ED = Exposure Duration BW = Bodyweight AT = Averaging Time		

Analyte	Dermal RfD (mg/kg-day)	Carc. Slope Dermal (mg/kg-day) ⁻¹	Permeability Coefficient K_p (cm/hr)	t_{event} (hr/event)	EPC Ground Water (mg/L)	Absorbed Dose/Event (mg/cm ² -event)	Industrial Worker			Construction Worker			Child Trespasser					
							Intake (mg/kg-day)		Hazard Quotient	Cancer Risk	Intake (mg/kg-day)		Hazard Quotient	Cancer Risk	Intake (mg/kg-day)		Hazard Quotient	Cancer Risk
							(Nc)	(Car)			(Nc)	(Car)			(Nc)	(Car)		
Metals							Dermal Contact to Ground Water Not Applicable for Industrial Worker						Dermal Contact to Ground Water Not Applicable for Child Trespasser					
Arsenic	3.E-04	1.5E+00	1.E-03	5.E-01	2.E-03	1.00E-09				9.75E-09	1.39E-10	3E-05	2E-10					
Thallium	6.E-04	N/A	1.E-03	5.E-01	4.E-03	2.00E-09				1.95E-08		3E-05						
Total Hazard Quotient and Cancer Risk:												6E-05	2E-10					
							Assumptions for Construction Worker BW = 70 kg SA = 2,490 cm ² EV = 1 event/day EF = 100 days/year ED = 1 years t_{event} = 0.5 hr/event AT (Nc) = 365 days AT (Car) = 25,550 days											

Note: Cells in this table were intentionally left blank due to a lack of toxicity data
NA= Information not available

**TABLE C-8
CALCULATION OF ABSORBED DOSE AND RISK FROM DERMAL CONTACT TO GROUNDWATER
CENTRAL TENDENCY (CT) - SEAD-59
SEAD-59 AND SEAD-71 PHASE II RI
Seneca Army Depot Activity**

Equation for Intake (mg/kg-day) = $\frac{DA \times SA \times EF \times ED \times EV}{BW \times AT}$	Equation for Absorbed Dose per Event (DA): For inorganics: $DA = K_p \times EPC \times t_{event} \times CF$	Equation for Hazard Quotient = Chronic Daily Intake (Nc)/Reference Dose
Variables (Assumptions for Each Receptor are Listed at the Bottom): DA = Absorbed Dose per Event, mg/cm ² -event SA = Surface Area Contact EF = Exposure Frequency EV = Event Frequency	K_p = Permeability Coefficient, cm/hr EPC = EPC in Groundwater, mg/L CF = Conversion Factor, 10 ⁻³ L/cm ³	Equation for Cancer Risk = Chronic Daily Intake (Car) x Slope Factor
ED = Exposure Duration BW = Bodyweight AT = Averaging Time		

Analyte	Dermal RfD (mg/kg-day)	Carc. Slope Dermal (mg/kg-day) ⁻¹	Permeability Coefficient K_p (cm/hr)	t_{event} (hr/event)	EPC Ground Water (mg/L)	Absorbed Dose/Event (mg/cm ² -event)	Industrial Worker			Construction Worker			Child Trespasser					
							Intake (mg/kg-day)		Hazard Quotient	Cancer Risk	Intake (mg/kg-day)		Hazard Quotient	Cancer Risk	Intake (mg/kg-day)		Hazard Quotient	Cancer Risk
							(Nc)	(Car)			(Nc)	(Car)			(Nc)	(Car)		
Metals							Dermal Contact to Ground Water Not Applicable for Industrial Worker						Dermal Contact to Ground Water Not Applicable for Child Trespasser					
Arsenic	3.E-04	1.5E+00	1.E-03	5.E-01	2.E-03	1.00E-09				7.75E-09	1.11E-10	3E-05	2E-10					
Thallium	6.E-04	N/A	1.E-03	5.E-01	4.E-03	2.00E-09				1.55E-08		2E-05						
Total Hazard Quotient and Cancer Risk:												5E-05	2E-10					
							Assumptions for Construction Worker											
							BW = 70 kg SA = 1,980 cm ² EV = 1 event/day EF = 100 days/year ED = 1 years t_{event} = 0.5 hr/event AT (Nc) = 365 days AT (Car) = 25,550 days											

Note: Cells in this table were intentionally left blank due to a lack of toxicity data
NA= Information not available

TABLE C-9
CALCULATION OF INTAKE AND RISK FROM THE INTAKE OF GROUNDWATER
REASONABLE MAXIMUM EXPOSURE (RME) - SEAD-59
SEAD-59 AND SEAD-71 PHASE II RI
Seneca Army Depot Activity

<p>Equation for Intake (mg/kg-day) = $\frac{EPC \times IR \times EF \times ED}{BW \times AT}$</p> <p>Variables (Assumptions for Each Receptor are Listed at the Bottom): EPC = Exposure Point Concentration in Groundwater (mg/L) ED=Exposure Duration IR = Intake Rate BW=Bodyweight EF = Exposure Frequency AT=Averaging Time</p>	<p>Equation for Hazard Quotient = Chronic Daily Intake (Nc)/Reference Dose</p> <p>Equation for Cancer Risk = Chronic Daily Intake (Car) x Slope Factor</p>
--	--

Analyte	Oral RfD (mg/kg-day)	Carc. Slope Oral (mg/kg-day) ⁻¹	EPC Groundwater (mg/liter)	Industrial Worker			Construction Worker			Child Trespasser					
				Intake (mg/kg-day)		Hazard Quotient	Cancer Risk	Intake (mg/kg-day)		Hazard Quotient	Cancer Risk	Intake (mg/kg-day)		Hazard Quotient	Cancer Risk
				(Nc)	(Car)			(Nc)	(Car)			(Nc)	(Car)		
Arsenic	3.E-04	1.5E+00	0.002	2.0E-05	7.0E-06	7E-02	1E-05	2.0E-05	2.8E-07	7E-02	4E-07	7.7E-06	6.6E-07	3E-02	1E-06
Thallium	6.E-04	N/A	0.004	3.9E-05	1.4E-05	6E-02		3.9E-05	5.6E-07	6E-02		1.5E-05	1.3E-06	2E-02	
Total Hazard Quotient and Cancer Risk:						1E-01	1E-05			1E-01	4E-07			5E-02	1E-06
				Assumptions for Industrial Worker			Assumptions for Construction Worker			Assumptions for Child Trespasser					
				BW =	70 kg	BW =	70 kg	BW =	15 kg						
				IR =	1 liters/day	IR =	1 liters/day	IR =	1.5 liters/day						
				EF =	250 days/year	EF =	250 days/year	EF =	14 days/year						
				ED =	25 years	ED =	1 years	ED =	6 years						
				AT (Nc) =	9,125 days	AT (Nc) =	365 days	AT (Nc) =	2,190 days						
				AT (Car) =	25,550 days	AT (Car) =	25,550 days	AT (Car) =	25,550 days						

Note: Cells in this table were intentionally left blank due to a lack of toxicity data.
N/A= Information not available.

TABLE C-10
CALCULATION OF INTAKE AND RISK FROM THE INTAKE OF GROUNDWATER
CENTRAL TENDENCY (CT) - SEAD-59
SEAD-59 AND SEAD-71 PHASE II RI
Seneca Army Depot Activity

Equation for Intake (mg/kg-day) = $\frac{EPC \times IR \times EF \times ED}{BW \times AT}$ Variables (Assumptions for Each Receptor are Listed at the Bottom): EPC = Exposure Point Concentration in Groundwater (mg/L) IR = Ingestion Rate EF = Exposure Frequency	Equation for Hazard Quotient = Chronic Daily Intake (Nc)/Reference Dose Equation for Cancer Risk = Chronic Daily Intake (Car) x Slope Factor ED=Exposure Duration BW=Bodyweight AT=Averaging Time
--	---

Analyte	Oral RfD (mg/kg-day)	Carc. Slope Oral (mg/kg-day)-1	EPC Groundwater (mg/liter)	Industrial Worker			Construction Worker			Child Trespasser					
				Intake (mg/kg-day)		Hazard Quotient	Cancer Risk	Intake (mg/kg-day)		Hazard Quotient	Cancer Risk	Intake (mg/kg-day)		Hazard Quotient	Cancer Risk
				(Nc)	(Car)			(Nc)	(Car)			(Nc)	(Car)		
Arsenic	3.E-04	1.5E+00	0.002	1.2E-05	1.5E-06	4E-02	2E-06	1.2E-05	1.7E-07	4E-02	3E-07	3.8E-06	3.2E-07	1E-02	5E-07
Thallium	6.E-04	N/A	0.004	2.4E-05	3.1E-06	4E-02		2.4E-05	3.4E-07	4E-02		7.6E-06	6.5E-07	1E-02	
Total Hazard Quotient and Cancer Risk:						8E-02	2E-06			8E-02	3E-07			2E-02	5E-07
				Assumptions for Industrial Worker			Assumptions for Construction Worker			Assumptions for Child Trespasser					
				BW =	70 kg	BW =		70 kg	BW =		15 kg				
				IR =	0.7 liters/day	IR =		0.7 liters/day	IR =		0.74 liters/day				
				EF =	219 days/year	EF =		219 days/year	EF =		14 days/year				
				ED =	9 years	ED =		1 years	ED =		6 years				
				AT (Nc) =	3,285 days	AT (Nc) =		365 days	AT (Nc) =		2,190 days				
				AT (Car) =	25,550 days	AT (Car) =		25,550 days	AT (Car) =		25,550 days				

Note: Cells in this table were intentionally left blank due to a lack of toxicity data.

N/A= Information not available.

Appendix D

SEAD-59 Stockpile Human Health Risk Assessment Calculation Tables

- D-1 Calculation of Intake and Risk from the Ingestion of Soil – RME
- D-2 Calculation of Intake and Risk from the Ingestion of Soil – CT
- D-3 Calculation of Absorbed Dose and Risk from Dermal Contact to Soil – RME
- D-4 Calculation of Absorbed Dose and Risk from Dermal Contact to Soil – CT
- D-5 Calculation of intake and Risk from Inhalation of Dust in Ambient Air – RME
- D-6 Calculation of intake and Risk from Inhalation of Dust in Ambient Air – CT
- D-7 Calculation of Blood Lead Concentration – Industrial Worker
- D-8 Calculation of Blood Lead Concentration – Construction Worker
- D-9 Calculation of Blood Lead Concentration – Child Trespasser/Child Visitor

**TABLE D-1
CALCULATION OF INTAKE AND RISK FROM THE INGESTION OF SOIL
REASONABLE MAXIMUM EXPOSURE (RME) - SEAD-59 STOCKPILE SOIL
SEAD-59 AND SEAD-71 PHASE II RI
Seneca Army Depot Activity**

Equation for Intake (mg/kg-day) =	$\frac{EPC \times IR \times CF \times FI \times EF \times ED \times B}{BW \times AT}$	Equation for Hazard Quotient = Chronic Daily Intake (Nc)/Reference Dose
Variables (Assumptions for Each Receptor are Listed at the Bottom):		Equation for Cancer Risk = Chronic Daily Intake (Car) x Slope Factor
EPC = Exposure Point Concentration in Soil, mg/kg	EF = Exposure Frequency	
IR = Ingestion Rate	ED = Exposure Duration	
CF = Conversion Factor	BW = Bodyweight	
FI = Fraction Ingested	B = Bioavailability	
	AT = Averaging Time	

Analyte	Oral RfD (mg/kg-day)	Carc. Slope Oral (mg/kg-day) ⁻¹	Bioavailability (unitless)	EPC Stockpile Soil (mg/kg)	Industrial Worker			Construction Worker			Child Trespasser					
					Intake (mg/kg-day)		Hazard Quotient	Cancer Risk	Intake (mg/kg-day)		Hazard Quotient	Cancer Risk	Intake (mg/kg-day)		Hazard Quotient	Cancer Risk
					(Nc)	(Car)			(Nc)	(Car)			(Nc)	(Car)		
Benzo(a)anthracene	N/A	7.3E-01	0.29	6.8E+00		6.89E-07		5E-07		9.10E-08		7E-08		8.64E-08		6E-08
Benzo(a)pyrene	N/A	7.3E+00	0.29	7.9E+00		8.01E-07		6E-06		1.06E-07		8E-07		1.00E-07		7E-07
Benzo(b)fluoranthene	N/A	7.3E-01	0.29	5.1E+00		5.17E-07		4E-07		6.82E-08		5E-08		6.48E-08		5E-08
Benzo(k)fluoranthene	N/A	7.3E-02	0.29	6.7E+00		6.79E-07		5E-08		8.96E-08		7E-09		8.52E-08		6E-09
Chrysene	N/A	7.3E-03	0.29	6.8E+00		6.89E-07		5E-09		9.10E-08		7E-10		8.64E-08		6E-10
Dibenz(a,h)anthracene	N/A	7.3E+00	0.29	1.2E+00		1.22E-07		9E-07		1.61E-08		1E-07		1.53E-08		1E-07
Indeno(1,2,3-cd)pyrene	N/A	7.3E-01	0.29	3.5E+00		3.55E-07		3E-07		4.68E-08		3E-08		4.45E-08		3E-08
Antimony	4.E-04	N/A	1	6.8E+00	6.65E-06		2E-02		2.20E-05	5E-02		3.48E-06	9E-03			
Arsenic	3.E-04	1.5E+00	1	4.9E+00	4.79E-06	1.71E-06	2E-02	3E-06	1.58E-05	5E-02	3E-07	2.51E-06	8E-03	2.15E-07		3E-07
Iron	3.E-01	N/A	1	2.1E+04	2.07E-02		7E-02		6.83E-02	2E-01		1.08E-02	4E-02			
Total Hazard Quotient and Cancer Risk:							1E-01	1E-05			3E-01	1E-06			5E-02	1E-06
					Assumptions for Industrial Worker			Assumptions for Construction Worker			Assumptions for Child Trespasser					
					CF =	1E-06 kg/mg	CF =	1E-06 kg/mg	CF =	1E-06 kg/mg	EPC =	EPC Surface Only	EPC =	EPC Surface Only		
					EPC =	EPC Surface Only	EPC =	EPC Surface and Subsurface	EPC =	EPC Surface Only	BW =	15 kg	BW =	15 kg		
					BW =	70 kg	BW =	70 kg	BW =	70 kg	IR =	200 mg/day	IR =	200 mg/day		
					IR =	100 mg/day	IR =	330 mg/day	IR =	330 mg/day	FI =	1 unitless	FI =	1 unitless		
					FI =	1 unitless	FI =	1 unitless	FI =	1 unitless	EF =	250 days/year	EF =	250 days/year	EF =	14 days/year
					EF =	250 days/year	EF =	250 days/year	EF =	250 days/year	ED =	6 years	ED =	6 years		
					ED =	25 years	ED =	1 years	ED =	1 years	AT (Nc) =	2,190 days	AT (Nc) =	2,190 days		
					AT (Nc) =	9,125 days	AT (Nc) =	365 days	AT (Nc) =	365 days	AT (Car) =	25,550 days	AT (Car) =	25,550 days		
					AT (Car) =	25,550 days	AT (Car) =	25,550 days	AT (Car) =	25,550 days	AT (Car) =	25,550 days	AT (Car) =	25,550 days		

Note: Cells in this table were intentionally left blank due to a lack of toxicity data.
NA= Information not available.

TABLE D-2
CALCULATION OF INTAKE AND RISK FROM THE INGESTION OF SOIL
CENTRAL TENDENCY (CT) - SEAD-59 STOCKPILE SOIL
SEAD-59 AND SEAD-71 PHASE II RI
Seneca Army Depot Activity

Equation for Intake (mg/kg-day) =	$\frac{EPC \times IR \times CF \times FI \times EF \times ED \times B}{BW \times AT}$	Equation for Hazard Quotient = Chronic Daily Intake (Nc)/Reference Dose
Variables (Assumptions for Each Receptor are Listed at the Bottom):		Equation for Cancer Risk = Chronic Daily Intake (Car) x Slope Factor
EPC = Exposure Point Concentration in Soil, mg/kg	EF = Exposure Frequency	
IR = Ingestion Rate	ED = Exposure Duration	
CF = Conversion Factor	B = Bioavailability	
FI = Fraction Ingested	BW = Bodyweight	
	AT = Averaging Time	

Analyte	Oral RfD (mg/kg-day)	Carc. Slope Oral (mg/kg-day) ⁻¹	Bioavailability (unitless)	EPC Stockpile Soil (mg/kg)	Industrial Worker				Construction Worker				Child Trespasser			
					Intake (mg/kg-day)		Hazard Quotient	Cancer Risk	Intake (mg/kg-day)		Hazard Quotient	Cancer Risk	Intake (mg/kg-day)		Hazard Quotient	Cancer Risk
					(Nc)	(Car)			(Nc)	(Car)			(Nc)	(Car)		
Benzo(a)anthracene	N/A	7.3E-01	0.29	6.8E+00		1.09E-07		8E-08		2.41E-08		2E-08		4.32E-08		3E-08
Benzo(a)pyrene	N/A	7.3E+00	0.29	7.9E+00		1.26E-07		9E-07		2.81E-08		2E-07		5.02E-08		4E-07
Benzo(b)fluoranthene	N/A	7.3E-01	0.29	5.1E+00		8.15E-08		6E-08		1.81E-08		1E-08		3.24E-08		2E-08
Benzo(k)fluoranthene	N/A	7.3E-02	0.29	6.7E+00		1.07E-07		8E-09		2.38E-08		2E-09		4.26E-08		3E-09
Chrysene	N/A	7.3E-03	0.29	6.8E+00		1.09E-07		8E-10		2.41E-08		2E-10		4.32E-08		3E-10
Dibenz(a,h)anthracene	N/A	7.3E+00	0.29	1.2E+00		1.92E-08		1E-07		4.26E-09		3E-08		7.63E-09		6E-08
Indeno(1,2,3-cd)pyrene	N/A	7.3E-01	0.29	3.5E+00		5.59E-08		4E-08		1.24E-08		9E-09		2.22E-08		2E-08
Antimony	4.E-04	N/A	1	6.8E+00	2.91E-06		7E-03		5.83E-06		1E-02		1.74E-06		4E-03	
Arsenic	3.E-04	1.5E+00	1	4.9E+00	2.10E-06	2.70E-07	7E-03	4E-07	4.20E-06	6.00E-08	1E-02	9E-08	1.25E-06	1.07E-07	4E-03	2E-07
Iron	3.E-01	N/A	1	2.1E+04	9.06E-03		3E-02		1.81E-02		6E-02		5.41E-03		2E-02	
Total Hazard Quotient and Cancer Risk:							4E-02	2E-06			9E-02	4E-07			3E-02	7E-07
					Assumptions for Industrial Worker				Assumptions for Construction Worker				Assumptions for Child Trespasser			
					CF =	1E-06 kg/mg			CF =	1E-06 kg/mg			CF =	1E-06 kg/mg		
					EPC =	EPC Surface Only			EPC =	EPC Surface and Subsurface			EPC =	EPC Surface Only		
					BW =	70 kg			BW =	70 kg			BW =	15 kg		
					IR =	50 mg/day			IR =	100 mg/day			IR =	100 mg/day		
					FI =	1 unitless			FI =	1 unitless			FI =	1 unitless		
					EF =	219 days/year			EF =	219 days/year			EF =	14 days/year		
					ED =	9 years			ED =	1 years			ED =	6 years		
					AT (Nc) =	3,285 days			AT (Nc) =	365 days			AT (Nc) =	2,190 days		
					AT (Car) =	25,550 days			AT (Car) =	25,550 days			AT (Car) =	25,550 days		

Note: Cells in this table were intentionally left blank due to a lack of toxicity data.
 NA= Information not available.

**TABLE D-3
CALCULATION OF ABSORBED DOSE AND RISK FROM DERMAL CONTACT TO SOIL
REASONABLE MAXIMUM EXPOSURE (RME) - SEAD-59 STOCKPILE SOIL
SEAD-59 AND SEAD-71 PHASE II RI
Seneca Army Depot Activity**

Equation for Intake (mg/kg-day) =	$\frac{EPC \times CF \times SA \times AF \times ABS \times EV \times EF \times ED}{BW \times AT}$
Variables (Assumptions for Each Receptor are Listed at the Bottom):	Equation for Hazard Quotient = Chronic Daily Intake (Nc)/Reference Dose
EPC = Exposure Point Concentration in Soil, mg/kg	EV = Event Frequency
CF = Conversion Factor	EF = Exposure Frequency
SA = Surface Area Contact	ED = Exposure Duration
AF = Adherence Factor	BW = Bodyweight
ABS = Absorption Factor	AT = Averaging Time
	Equation for Cancer Risk = Chronic Daily Intake (Car) x Slope Factor

Analyte	Dermal RfD (mg/kg-day)	Carc. Slope Dermal (mg/kg-day)-1	Absorption Factor* (unitless)	EPC Stockpile Soil (mg/kg)	Industrial Worker			Construction Worker			Child Trespasser					
					Absorbed Dose (mg/kg-day)		Hazard Quotient	Cancer Risk	Absorbed Dose (mg/kg-day)		Hazard Quotient	Cancer Risk	Absorbed Dose (mg/kg-day)		Hazard Quotient	Cancer Risk
					(Nc)	(Car)			(Nc)	(Car)			(Nc)	(Car)		
Benzo(a)anthracene	N/A	7.3E-01	1.3E-01	6.8E+00		2.04E-06		1E-06		1.22E-07		9E-08		1.09E-07		7.92E-08
Benzo(a)pyrene	N/A	7.3E+00	1.3E-01	7.9E+00		2.37E-06		2E-05		1.42E-07		1E-06		1.26E-07		9.20E-07
Benzo(b)fluoranthene	N/A	7.3E-01	1.3E-01	5.1E+00		1.53E-06		1E-06		9.17E-08		7E-08		8.14E-08		5.94E-08
Benzo(k)fluoranthene	N/A	7.3E-02	1.3E-01	6.7E+00		2.01E-06		1E-07		1.21E-07		9E-09		1.07E-07		7.80E-09
Chrysene	N/A	7.3E-03	1.3E-01	6.8E+00		2.04E-06		1E-08		1.22E-07		9E-10		1.09E-07		7.92E-10
Dibenz(a,h)anthracene	N/A	7.3E+00	1.3E-01	1.2E+00		3.60E-07		3E-06		2.16E-08		2E-07		1.91E-08		1.40E-07
Indeno(1,2,3-cd)pyrene	N/A	7.3E-01	1.3E-01	3.5E+00		1.05E-06		8E-07		6.30E-08		5E-08		5.58E-08		4.08E-08
Antimony	6.E-05	N/A	1E-03	6.8E+00	4.39E-08		7E-04		6.59E-08		1E-03		9.74E-09		1.62E-04	
Arsenic	3.E-04	1.5E+00	3E-02	4.9E+00	9.49E-07	3.39E-07	3E-03	5E-07	1.42E-06	2.03E-08	5E-03	3E-08	2.10E-07	1.80E-08	7.02E-04	2.71E-08
Iron	3.E-01	N/A	1E-03	2.1E+04	1.37E-04		5E-04		2.05E-04		7E-04		3.03E-05		1.01E-04	
Total Hazard Quotient and Cancer Risk:							4E-03	2E-05			7E-03	1E-06			1E-03	1E-06
					Assumptions for Industrial Worker			Assumptions for Construction Worker			Assumptions for Child Trespasser					
					CF =	1E-06 kg/mg	CF =	1E-06 kg/mg	CF =	1E-06 kg/mg						
					CS =	EPC Surface Only	EPC =	EPC Surface and Subsurface	EPC =	EPC Surface Only						
					BW =	70 kg	BW =	70 kg	BW =	15 kg						
					SA =	3,300 cm ²	SA =	3,300 cm ²	SA =	2,800 cm ²						
					AF =	0.2 mg/cm ² -event	AF =	0.3 mg/cm ² -event	AF =	0.2 mg/cm ² -event						
					EV =	1 event/day	EV =	1 event/day	EV =	1 event/day						
					EF =	250 days/year	EF =	250 days/year	EF =	14 days/year						
					ED =	25 years	ED =	1 years	ED =	6 years						
					AT (Nc) =	9,125 days	AT (Nc) =	365 days	AT (Nc) =	2,190 days						
					AT (Car) =	25,550 days	AT (Car) =	25,550 days	AT (Car) =	25,550 days						

Note: Cells in this table were intentionally left blank due to a lack of toxicity data.

N/A= Information not available.

* Absorption factors from Exhibit 3-4 of USEPA (2004) Supplemental Guidance for Dermal Risk Assessment, Part E of Risk Assessment Guidance for Superfund, Human Health Evaluation Manual (Volume I).

Absorption factors for antimony and iron were assumed to be 0.001 in accordance with the USEPA Region 4 (2000)

Supplemental Guidance to RAGS: Region 4 Bulletins, Human Health Risk Assessment Bulletins (<http://www.epa.gov/region4/waste/ots/healthbul.htm>).

**TABLE D-4
CALCULATION OF ABSORBED DOSE AND RISK FROM DERMAL CONTACT TO SOIL
CENTRAL TENDENCY (CT) - SEAD-59 STOCKPILE SOIL
SEAD-59 AND SEAD-71 PHASE II RI
Seneca Army Depot Activity**

Equation for Intake (mg/kg-day) =	$\frac{EPC \times CF \times SA \times AF \times ABS \times EV \times EF \times ED}{BW \times AT}$
Variables (Assumptions for Each Receptor are Listed at the Bottom):	Equation for Hazard Quotient = Chronic Daily Intake (Nc)/Reference Dose
EPC = Exposure Point Concentration in Soil, mg/kg	EV = Event Frequency
CF = Conversion Factor	EF = Exposure Frequency
SA = Surface Area Contact	ED = Exposure Duration
AF = Adherence Factor	BW = Bodyweight
ABS = Absorption Factor	AT = Averaging Time
	Equation for Cancer Risk = Chronic Daily Intake (Car) x Slope Factor

Analyte	Dermal RfD (mg/kg-day)	Carc. Slope Dermal (mg/kg-day)-1	Absorption Factor* (unitless)	EPC Stockpile Soil (mg/kg)	Industrial Worker				Construction Worker				Child Trespasser			
					Absorbed Dose (mg/kg-day)		Hazard Quotient	Cancer Risk	Absorbed Dose (mg/kg-day)		Hazard Quotient	Cancer Risk	Absorbed Dose (mg/kg-day)		Hazard Quotient	Cancer Risk
					(Nc)	(Car)			(Nc)	(Car)			(Nc)	(Car)		
Benzo(a)anthracene	N/A	7.3E-01	1.3E-01	6.8E+00		6.43E-08		5E-08		1.07E-07		8E-08		2.17E-08		1.58E-08
Benzo(a)pyrene	N/A	7.3E+00	1.3E-01	7.9E+00		7.47E-08		5E-07		1.24E-07		9E-07		2.52E-08		1.84E-07
Benzo(b)fluoranthene	N/A	7.3E-01	1.3E-01	5.1E+00		4.82E-08		4E-08		8.04E-08		6E-08		1.63E-08		1.19E-08
Benzo(k)fluoranthene	N/A	7.3E-02	1.3E-01	6.7E+00		6.34E-08		5E-09		1.06E-07		8E-09		2.14E-08		1.56E-09
Chrysene	N/A	7.3E-03	1.3E-01	6.8E+00		6.43E-08		5E-10		1.07E-07		8E-10		2.17E-08		1.58E-10
Dibenz(a,h)anthracene	N/A	7.3E+00	1.3E-01	1.2E+00		1.13E-08		8E-08		1.89E-08		1E-07		3.83E-09		2.80E-08
Indeno(1,2,3-cd)pyrene	N/A	7.3E-01	1.3E-01	3.5E+00		3.31E-08		2E-08		5.52E-08		4E-08		1.12E-08		8.15E-09
Antimony	6.E-05	N/A	1E-03	6.8E+00	3.85E-09		6E-05		5.77E-08	1E-03		3E-08	1.95E-09	3.25E-05		
Arsenic	3.E-04	1.5E+00	3E-02	4.9E+00	8.32E-08	1.07E-08	3E-04	2E-08	1.25E-06	4E-03		3E-08	4.21E-08	1.40E-04		5.41E-09
Iron	3.E-01	N/A	1E-03	2.1E+04	1.56E-05		5E-05		2.33E-04	8E-04			7.87E-06	2.62E-05		
Total Hazard Quotient and Cancer Risk:							4E-04	8E-07			6E-03	1E-06			2E-04	3E-07
					Assumptions for Industrial Worker				Assumptions for Construction Worker				Assumptions for Child Trespasser			
					CF =	1E-06 kg/mg			CF =	1E-06 kg/mg			CF =	1E-06 kg/mg		
					CS =	EPC Surface Only			EPC =	EPC Surface and Subsurface			EPC =	EPC Surface Only		
					BW =	70 kg			BW =	70 kg			BW =	15 kg		
					SA =	3,300 cm ²			SA =	3,300 cm ²			SA =	2,800 cm ²		
					AF =	0.02 mg/cm ² -event			AF =	0.3 mg/cm ² -event			AF =	0.04 mg/cm ² -event		
					EV =	1 event/day			EV =	1 event/day			EV =	1 event/day		
					EF =	219 days/year			EF =	219 days/year			EF =	14 days/year		
					ED =	9 years			ED =	1 years			ED =	6 years		
					AT (Nc) =	3,285 days			AT (Nc) =	365 days			AT (Nc) =	2,190 days		
					AT (Car) =	25,550 days			AT (Car) =	25,550 days			AT (Car) =	25,550 days		

Note: Cells in this table were intentionally left blank due to a lack of toxicity data.

N/A= Information not available.

* Absorption factors from Exhibit 3-4 of USEPA (2004) Supplemental Guidance for Dermal Risk Assessment, Part E of Risk Assessment Guidance for Superfund, Human Health Evaluation Manual (Volume I).

Absorption factors for antimony and iron were assumed to be 0.001 in accordance with the USEPA Region 4 (2000)

Supplemental Guidance to RAGS: Region 4 Bulletins, Human Health Risk Assessment Bulletins (<http://www.epa.gov/region4/waste/ots/healthbul.htm>).

TABLE D-5
CALCULATION OF INTAKE AND RISK FROM INHALATION OF DUST IN AMBIENT AIR
REASONABLE MAXIMUM EXPOSURE (RME) - SEAD-59 STOCKPILE SOIL
SEAD-59 AND SEAD-71 PHASE II RI
Seneca Army Depot Activity

Equation for Intake (mg/kg-day) = $\frac{CA \times IR \times EF \times ED}{BW \times AT}$ Variables (Assumptions for Each Receptor are Listed at the Bottom): CA = Chemical Concentration in Air, Calculated from Air EPC Data ED = Exposure Duration IR = Inhalation Rate BW = Bodyweight EF = Exposure Frequency AT = Averaging Time	Equation for Hazard Quotient = Chronic Daily Intake (Nc)/Reference Dose Equation for Cancer Risk = Chronic Daily Intake (Car) x Slope Factor
---	---

Analyte	Inhalation RfD (mg/kg-day)	Carc. Slope Inhalation (mg/kg-day)-1	Air EPC from Stockpile Soil (mg/m3)	Industrial Worker			Construction Worker			Child Trespasser					
				Intake (mg/kg-day)		Hazard Quotient	Cancer Risk	Intake (mg/kg-day)		Hazard Quotient	Cancer Risk	Intake (mg/kg-day)		Hazard Quotient	Cancer Risk
				(Nc)	(Car)			(Nc)	(Car)			(Nc)	(Car)		
Benzo(a)anthracene	N/A	N/A	1.2E-07												
Benzo(a)pyrene	N/A	3.1E+00	1.3E-07		9.39E-09		3E-08		3.75E-10		1E-09		3.53E-10	1E-09	
Benzo(b)fluoranthene	N/A	N/A	8.7E-08												
Benzo(k)fluoranthene	N/A	N/A	1.1E-07												
Chrysene	N/A	N/A	1.2E-07												
Dibenz(a,h)anthracene	N/A	N/A	2.0E-08												
Indeno(1,2,3-cd)pyrene	N/A	N/A	6.0E-08												
Antimony	N/A	N/A	1.2E-07												
Arsenic	N/A	1.5E+01	8.3E-08		5.82E-09		9E-08		2.33E-10		4E-09		2.19E-10	3E-09	
Iron	N/A	N/A	3.6E-04												
Total Hazard Quotient and Cancer Risk:							1E-07				5E-09			4E-09	
				Assumptions for Industrial Worker			Assumptions for Construction Worker			Assumptions for Child Trespasser					
				CA =	EPC Stockpile	CA =	EPC Stockpile	CA =	EPC Stockpile						
				BW =	70 kg	BW =	70 kg	BW =	15 kg						
				IR =	20 m3/day	IR =	20 m3/day	IR =	12 m3/day						
				EF =	250 days/year	EF =	250 days/year	EF =	14 days/year						
				ED =	25 years	ED =	1 year	ED =	6 years						
				AT (Nc) =	9,125 days	AT (Nc) =	365 days	AT (Nc) =	2,190 days						
				AT (Car) =	25,550 days	AT (Car) =	25,550 days	AT (Car) =	25,550 days						

Note: Cells in this table were intentionally left blank due to a lack of toxicity data.
 NA= Information not available.

TABLE D-6
CALCULATION OF INTAKE AND RISK FROM INHALATION OF DUST IN AMBIENT AIR
CENTRAL TENDENCY (CT) - SEAD-59 STOCKPILE SOIL
SEAD-59 AND SEAD-71 PHASE II RI
Seneca Army Depot Activity

Equation for Intake (mg/kg-day) = $\frac{EPC \times IR \times EF \times ED}{BW \times AT}$	Equation for Hazard Quotient = Chronic Daily Intake (Nc)/Reference Dose
Variables (Assumptions for Each Receptor are Listed at the Bottom): EPC = EPC in Air, mg/m ³ IR = Inhalation Rate EF = Exposure Frequency	Equation for Cancer Risk = Chronic Daily Intake (Car) x Slope Factor
ED = Exposure Duration BW = Bodyweight AT = Averaging Time	

Analyte	Inhalation RID (mg/kg-day)	Carc. Slope Inhalation (mg/kg-day)-1	Air EPC from Stockpile Soil (mg/m ³)	Industrial Worker				Construction Worker				Child Trespasser			
				Intake (mg/kg-day)		Hazard Quotient	Cancer Risk	Intake (mg/kg-day)		Hazard Quotient	Cancer Risk	Intake (mg/kg-day)		Hazard Quotient	Cancer Risk
				(Nc)	(Car)			(Nc)	(Car)			(Nc)	(Car)		
Benzo(a)anthracene	N/A	N/A	1.2E-07												
Benzo(a)pyrene	N/A	3.1E+00	1.3E-07		1.54E-09		5E-09		3.29E-10		1E-09		3.53E-10		1E-09
Benzo(b)fluoranthene	N/A	N/A	8.7E-08												
Benzo(k)fluoranthene	N/A	N/A	1.1E-07												
Chrysene	N/A	N/A	1.2E-07												
Dibenz(a,h)anthracene	N/A	N/A	2.0E-08												
Indeno(1,2,3-cd)pyrene	N/A	N/A	6.0E-08												
Antimony	N/A	N/A	1.2E-07												
Arsenic	N/A	1.5E+01	8.3E-08		9.55E-10		1E-08		2.04E-10		3E-09		2.19E-10		3E-09
Iron	N/A	N/A	3.6E-04												
Total Hazard Quotient and Cancer Risk:							2E-08				4E-09				4E-09
				Assumptions for Industrial Worker				Assumptions for Construction Worker				Assumptions for Child Trespasser			
				CA =	EPC Stockpile	CA =	EPC Stockpile	CA =	EPC Stockpile	CA =	EPC Stockpile	CA =	EPC Stockpile	CA =	EPC Stockpile
				BW =	70 kg	BW =	70 kg	BW =	70 kg	BW =	15 kg	BW =	15 kg	BW =	15 kg
				IR =	10.4 m ³ /day	IR =	20 m ³ /day	IR =	20 m ³ /day	IR =	12 m ³ /day	IR =	12 m ³ /day	IR =	12 m ³ /day
				EF =	219 days/year	EF =	219 days/year	EF =	219 days/year	EF =	14 days/year	EF =	14 days/year	EF =	14 days/year
				ED =	9 years	ED =	1 year	ED =	1 year	ED =	6 years	ED =	6 years	ED =	6 years
				AT (Nc) =	3,285 days	AT (Nc) =	365 days	AT (Nc) =	365 days	AT (Nc) =	2,190 days	AT (Nc) =	2,190 days	AT (Nc) =	2,190 days
				AT (Car) =	25,550 days	AT (Car) =	25,550 days	AT (Car) =	25,550 days	AT (Car) =	25,550 days	AT (Car) =	25,550 days	AT (Car) =	25,550 days

Note: Cells in this table were intentionally left blank due to a lack of toxicity data.

NA= Information not available.

Table D-7
Calculation of Blood Lead Concentration - Industrial Worker Exposed to SEAD-59 Stockpile Soil
SEAD-59 AND SEAD-71 PHASE II RI
Seneca Army Depot Activity

Calculations of Blood Lead Concentrations (PbBs)
 U.S. EPA Technical Review Workgroup for Lead, Adult Lead Committee

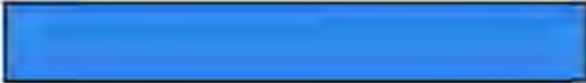

Version date 05/19/03

Exposure Variable	PbB Equation ¹		Description of Exposure Variable	Units	Values for Non-Residential Exposure Scenario			
	1*	2**			Using Equation 1		Using Equation 2	
					GSDi = Hom	GSDi = Het	GSDi = Hom	GSDi = Het
PbS	X	X	Soil lead concentration	ug/g or ppm	79	79	79	79
R _{fetal/maternal}	X	X	Fetal/maternal PbB ratio	--	0.9	0.9	0.9	0.9
BKSF	X	X	Biokinetic Slope Factor	ug/dL per ug/day	0.4	0.4	0.4	0.4
GSD _i	X	X	Geometric standard deviation PbB	--	1.9	2.1	1.9	2.1
PbB ₀	X	X	Baseline PbB	ug/dL	1.7	2.2	1.7	2.2
IR _S	X		Soil ingestion rate (including soil-derived indoor dust)	g/day	0.050	0.050	--	--
IR _{S+D}		X	Total ingestion rate of outdoor soil and indoor dust	g/day	--	--	0.050	0.050
W _S		X	Weighting factor; fraction of IR _{S+D} ingested as outdoor soil	--	--	--	1.0	1.0
K _{SD}		X	Mass fraction of soil in dust	--	--	--	0.7	0.7
AF _{S,D}	X	X	Absorption fraction (same for soil and dust)	--	0.12	0.12	0.12	0.12
EF _{S,D}	X	X	Exposure frequency (same for soil and dust)	days/yr	219	219	219	219
AT _{S,D}	X	X	Averaging time (same for soil and dust)	days/yr	365	365	365	365
PbB_{adult}	PbB of adult worker, geometric mean			ug/dL	1.8	2.3	1.8	2.3
PbB_{fetal, 0.95}	95th percentile PbB among fetuses of adult workers			ug/dL	4.7	7.1	4.7	7.1
PbB_t	Target PbB level of concern (e.g., 10 ug/dL)			ug/dL	10.0	10.0	10.0	10.0
P(PbB_{fetal} > PbB_t)	Probability that fetal PbB > PbB_t, assuming lognormal distribution			%	0.2%	1.7%	0.2%	1.7%

¹ Equation 1 does not apportion exposure between soil and dust ingestion (excludes W_S, K_{SD}).
 When IR_S = IR_{S+D} and W_S = 1.0, the equations yield the same PbB_{fetal,0.95}.

***Equation 1, based on Eq. 1, 2 in USEPA (1996).**

PbB_{adult} =	$(PbS * BKSF * IR_{S+D} * AF_{S,D} * EF_S / AT_{S,D}) + PbB_0$
PbB_{fetal, 0.95} =	$PbB_{adult} * (GSD_i^{1.645} * R)$

****Equation 2, alternate approach based on Eq. 1, 2, and A-19 in USEPA (1996).**

PbB_{adult} =	$PbS * BKSF * ((IR_{S+D} * AF_S * EF_S * W_S) + [K_{SD} * (IR_{S+D}) * (1 - W_S) * AF_D * EF_D]) / 365 + PbB_0$
PbB_{fetal, 0.95} =	$PbB_{adult} * (GSD_i^{1.645} * R)$

Source: U.S. EPA (1996). Recommendations of the Technical Review Workgroup for Lead for an Interim Approach to Assessing Risks Associated with Adult Exposures to Lead in Soil

Table D-8
Calculation of Blood Lead Concentration - Construction Worker Exposed to SEAD-59 Stockpile Soil
SEAD-59 AND SEAD-71 PHASE II RI
Seneca Army Depot Activity

Calculations of Blood Lead Concentrations (PbBs)
 U.S. EPA Technical Review Workgroup for Lead, Adult Lead Committee

Version date 05/19/03

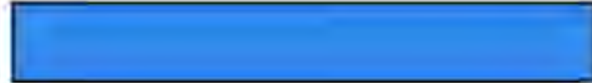

Exposure Variable	PbB Equation ¹		Description of Exposure Variable	Units	Values for Non-Residential Exposure Scenario			
	1*	2**			Using Equation 1		Using Equation 2	
					GSDi = Hom	GSDi = Het	GSDi = Hom	GSDi = Het
PbS	X	X	Soil lead concentration	ug/g or ppm	79	79	79	79
R _{fetal/maternal}	X	X	Fetal/maternal PbB ratio	--	0.9	0.9	0.9	0.9
BKSF	X	X	Biokinetic Slope Factor	ug/dL per ug/day	0.4	0.4	0.4	0.4
GSD _i	X	X	Geometric standard deviation PbB	--	1.9	2.1	1.9	2.1
PbB ₀	X	X	Baseline PbB	ug/dL	1.7	2.2	1.7	2.2
IR _S	X		Soil ingestion rate (including soil-derived indoor dust)	g/day	0.100	0.100	--	--
IR _{S+D}		X	Total ingestion rate of outdoor soil and indoor dust	g/day	--	--	0.100	0.100
W _S		X	Weighting factor; fraction of IR _{S+D} ingested as outdoor soil	--	--	--	1.0	1.0
K _{SD}		X	Mass fraction of soil in dust	--	--	--	0.7	0.7
AF _{S,D}	X	X	Absorption fraction (same for soil and dust)	--	0.12	0.12	0.12	0.12
EF _{S,D}	X	X	Exposure frequency (same for soil and dust)	days/yr	219	219	219	219
AT _{S,D}	X	X	Averaging time (same for soil and dust)	days/yr	365	365	365	365
PbB_{adult}	PbB of adult worker, geometric mean			ug/dL	1.9	2.4	1.9	2.4
PbB_{fetal, 0.95}	95th percentile PbB among fetuses of adult workers			ug/dL	5.0	7.4	5.0	7.4
PbB_t	Target PbB level of concern (e.g., 10 ug/dL)			ug/dL	10.0	10.0	10.0	10.0
P(PbB_{fetal} > PbB_t)	Probability that fetal PbB > PbB_t, assuming lognormal distribution			%	0.3%	2.0%	0.3%	2.0%

¹ Equation 1 does not apportion exposure between soil and dust ingestion (excludes W_S, K_{SD}).
 When IR_S = IR_{S+D} and W_S = 1.0, the equations yield the same PbB_{fetal,0.95}.

***Equation 1, based on Eq. 1, 2 in USEPA (1996).**

PbB_{adult} =	$(PbS * BKSF * IR_{S+D} * AF_{S,D} * EF_S / AT_{S,D}) + PbB_0$
PbB_{fetal, 0.95} =	$PbB_{adult} * (GSD_i^{1.645} * R)$

****Equation 2, alternate approach based on Eq. 1, 2, and A-19 in USEPA (1996).**

PbB_{adult} =	$PbS * BKSF * ((IR_{S+D} * AF_S * EF_S * W_S) + [K_{SD} * (IR_{S+D}) * (1 - W_S) * AF_D * EF_D]) / 365 + PbB_0$
PbB_{fetal, 0.95} =	$PbB_{adult} * (GSD_i^{1.645} * R)$

Source: U.S. EPA (1996). Recommendations of the Technical Review Workgroup for Lead for an Interim Approach to Assessing Risks Associated with Adult Exposures to Lead in Soil

SEAD59stock_lead_I EUBK
 Table D-9
 Calculation of Blood Lead Concentration - Child Exposed to
 SEAD-59 Stockpile Soil
 SEAD-59 and SEAD-71 Phase II RI
 Seneca Army Depot Activity

LEAD MODEL FOR WINDOWS Version 1.0

```
=====
Model Version: 1.0 Build 261
User Name:
Date:
Site Name:
Operable Unit:
Run Mode: Research
=====
```

The time step used in this model run: 1 - Every 4 Hours (6 times a day).

***** Air *****

Indoor Air Pb Concentration: 30.000 percent of outdoor.
 Other Air Parameters:

Age	Time Outdoors (hours)	Ventilation Rate (m ³ /day)	Lung Absorption (%)	Outdoor Air Pb Conc (ug Pb/m ³)
.5-1	1.000	2.000	32.000	0.100
1-2	2.000	3.000	32.000	0.100
2-3	3.000	5.000	32.000	0.100
3-4	4.000	5.000	32.000	0.100
4-5	4.000	5.000	32.000	0.100
5-6	4.000	7.000	32.000	0.100
6-7	4.000	7.000	32.000	0.100

***** Diet *****

Age	Diet Intake(ug/day)
.5-1	5.530
1-2	5.780
2-3	6.490
3-4	6.240
4-5	6.010
5-6	6.340
6-7	7.000

***** Drinking Water *****

Water Consumption:

Age	Water (L/day)
.5-1	0.200
1-2	0.500
2-3	0.520
3-4	0.530
4-5	0.550
5-6	0.580
6-7	0.590

Drinking Water Concentration: 0.000 ug Pb/L

SEAD59stock_Lead_I EUBK

***** Soil & Dust *****

Multiple Source Analysis Used

Average multiple source concentration: 65.300 ug/g

Mass fraction of outdoor soil to indoor dust conversion factor: 0.700

Outdoor airborne lead to indoor household dust lead concentration: 100.000

Use alternate indoor dust Pb sources? No

Age	Soil (ug Pb/g)	House Dust (ug Pb/g)
.5-1	79.000	65.300
1-2	79.000	65.300
2-3	79.000	65.300
3-4	79.000	65.300
4-5	79.000	65.300
5-6	79.000	65.300
6-7	79.000	65.300

***** Alternate Intake *****

Age	Alternate (ug Pb/day)
.5-1	0.000
1-2	0.000
2-3	0.000
3-4	0.000
4-5	0.000
5-6	0.000
6-7	0.000

***** Maternal Contribution: Infant Model *****

Maternal Blood Concentration: 2.500 ug Pb/dL

 CALCULATED BLOOD LEAD AND LEAD UPTAKES:

Year	Air (ug/day)	Diet (ug/day)	Alternate (ug/day)	Water (ug/day)
.5-1	0.021	2.631	0.000	0.000
1-2	0.034	2.754	0.000	0.000
2-3	0.062	3.107	0.000	0.000
3-4	0.067	3.008	0.000	0.000
4-5	0.067	2.924	0.000	0.000
5-6	0.093	3.095	0.000	0.000
6-7	0.093	3.420	0.000	0.000

Year	Soil +Dust (ug/day)	Total (ug/day)	Blood (ug/dL)
.5-1	1.734	4.386	2.4
1-2	2.758	5.547	2.4
2-3	2.771	5.939	2.2
3-4	2.790	5.864	2.1
4-5	2.086	5.077	1.8
5-6	1.884	5.072	1.6
6-7	1.781	5.294	1.5

Appendix E

SEAD-71 Human Health Risk Assessment Calculation Tables

- E-1 Calculation of Intake and Risk from the Ingestion of Soil – RME
- E-2 Calculation of Intake and Risk from the Ingestion of Soil – CT
- E-3 Calculation of Absorbed Dose and Risk from Dermal Contact to Soil – RME
- E-4 Calculation of Absorbed Dose and Risk from Dermal Contact to Soil – CT
- E-5 Calculation of intake and Risk from Inhalation of Dust in Ambient Air – RME
- E-6 Calculation of intake and Risk from Inhalation of Dust in Ambient Air – CT
- E-7 Calculation of Absorbed Dose and Risk from Dermal Contact to Groundwater – RME
- E-8 Calculation of Absorbed Dose and Risk from Dermal Contact to Groundwater – CT
- E-9 Calculation of Intake and Risk from the Intake of Groundwater – RME
- E-10 Calculation of Intake and Risk from the Intake of Groundwater – CT
- E-11 Calculation of Blood Lead Concentration – Industrial Worker
- E-12 Calculation of Blood Lead Concentration – Construction Worker
- E-13 Calculation of Blood Lead Concentration – Child Trespasser/Child Visitor

**TABLE E-1
CALCULATION OF INTAKE AND RISK FROM THE INGESTION OF SOIL
REASONABLE MAXIMUM EXPOSURE (RME) - SEAD-71
SEAD-59 AND SEAD-71 PHASE II RI
Seneca Army Depot Activity**

Equation for Intake (mg/kg-day) =	$\frac{EPC \times IR \times CF \times FI \times EF \times ED \times B}{BW \times AT}$	Equation for Hazard Quotient = Chronic Daily Intake (Nc)/Reference Dose
Variables (Assumptions for Each Receptor are Listed at the Bottom):		Equation for Cancer Risk = Chronic Daily Intake (Car) x Slope Factor
EPC = Exposure Point Concentration in Soil, mg/kg		
IR = Ingestion Rate		EF = Exposure Frequency
CF = Conversion Factor	B = Bioavailability	ED = Exposure Duration
FI = Fraction Ingested		BW = Bodyweight
		AT = Averaging Time

Analyte	Oral RfD (mg/kg-day)	Carc. Slope Oral (mg/kg-day) ⁻¹	Bioavailability (unitless)	EPC Surface Soil (mg/kg)	EPC from Total Soils (mg/kg)	Industrial Worker			Construction Worker			Child Trespasser					
						Intake (mg/kg-day)		Hazard Quotient	Cancer Risk	Intake (mg/kg-day)		Hazard Quotient	Cancer Risk	Intake (mg/kg-day)		Hazard Quotient	Cancer Risk
						(Nc)	(Car)			(Nc)	(Car)			(Nc)	(Car)		
Benzo(a)anthracene	N/A	7.3E-01	0.29	4.3E+01	3.9E+01		4.32E-06		3E-06		5.23E-07		4E-07		5.42E-07		4E-07
Benzo(a)pyrene	N/A	7.3E+00	0.29	3.5E+01	3.2E+01		3.53E-06		3E-05		4.23E-07		3E-06		4.42E-07		3E-06
Benzo(b)fluoranthene	N/A	7.3E-01	0.29	2.8E+01	2.6E+01		2.86E-06		2E-06		3.47E-07		3E-07		3.58E-07		3E-07
Benzo(k)fluoranthene	N/A	7.3E-02	0.29	3.6E+01	3.2E+01		3.62E-06		3E-07		4.32E-07		3E-08		4.54E-07		3E-08
Carbazole	N/A	2.0E-02	1	2.6E+01	2.2E+01		8.91E-06		2E-07		1.02E-06		2E-08		1.12E-06		2E-08
Chrysene	N/A	7.3E-03	0.29	4.2E+01	3.8E+01		4.22E-06		3E-08		5.10E-07		4E-09		5.29E-07		4E-09
Dibenz(a,h)anthracene	N/A	7.3E+00	0.29	5.4E+00	5.1E+00		5.47E-07		4E-06		6.82E-08		5E-07		6.86E-08		5E-07
Indeno(1,2,3-cd)pyrene	N/A	7.3E-01	0.29	1.3E+01	1.2E+01		1.30E-06		9E-07		1.57E-07		1E-07		1.63E-07		1E-07
Heptachlor epoxide	1.E-05	9.1E+00	1	2.4E-02	2.2E-02	2.35E-08	8.39E-09	2E-03	8E-08	7.10E-08	1.01E-09	5E-03	9E-09	1.23E-08	1.05E-09	9E-04	1E-08
Arsenic	3.E-04	1.5E+00	1	6.3E+00	6.2E+00	6.16E-06	2.20E-06	2E-02	3E-06	2.00E-05	2.86E-07	7E-02	4E-07	3.22E-06	2.76E-07	1E-02	4E-07
Iron	3.E-01	N/A	1	2.5E+04	2.4E+04	2.43E-02		8E-02		7.88E-02		3E-01		1.27E-02		4E-02	
Total Hazard Quotient and Cancer Risk:								1E-01	4E-05			3E-01	5E-06			5E-02	5E-06
						Assumptions for Industrial Worker			Assumptions for Construction Worker			Assumptions for Child Trespasser					
						CF =	1E-06 kg/mg			CF =	1E-06 kg/mg			CF =	1E-06 kg/mg		
						EPC=	EPC Surface Only			EPC=	EPC Surface and Subsurface			EPC=	EPC Surface Only		
						BW =	70 kg			BW =	70 kg			BW =	15 kg		
						IR =	100 mg/day			IR =	330 mg/day			IR =	200 mg/day		
						FI =	1 unitless			FI =	1 unitless			FI =	1 unitless		
						EF =	250 days/year			EF =	250 days/year			EF =	14 days/year		
						ED =	25 years			ED =	1 years			ED =	6 years		
						AT (Nc) =	9,125 days			AT (Nc) =	365 days			AT (Nc) =	2,190 days		
						AT (Car) =	25,550 days			AT (Car) =	25,550 days			AT (Car) =	25,550 days		

Note: Cells in this table were intentionally left blank due to a lack of toxicity data.
NA= Information not available.

**TABLE E-2
CALCULATION OF INTAKE AND RISK FROM THE INGESTION OF SOIL
CENTRAL TENDENCY (CT) - SEAD-71
SEAD-59 AND SEAD-71 PHASE II RI
Seneca Army Depot Activity**

Equation for Intake (mg/kg-day) =	$\frac{EPC \times IR \times CF \times FI \times EF \times ED \times B}{BW \times AT}$	
Variables (Assumptions for Each Receptor are Listed at the Bottom):		Equation for Hazard Quotient = Chronic Daily Intake (Nc)/Reference Dose
EPC = Exposure Point Concentration in Soil, mg/kg		Equation for Cancer Risk = Chronic Daily Intake (Car) x Slope Factor
IR = Ingestion Rate		
CF = Conversion Factor	B = Bioavailability	
FI = Fraction Ingested		
	EF = Exposure Frequency	
	ED = Exposure Duration	
	BW = Bodyweight	
	AT = Averaging Time	

Analyte	Oral RfD (mg/kg-day)	Carc. Slope Oral (mg/kg-day) ⁻¹	Bioavailability (unitless)	EPC Surface Soil (mg/kg)	EPC from Total Soils (mg/kg)	Industrial Worker			Construction Worker			Child Trespasser					
						Intake (mg/kg-day)		Hazard Quotient	Cancer Risk	Intake (mg/kg-day)		Hazard Quotient	Cancer Risk	Intake (mg/kg-day)		Hazard Quotient	Cancer Risk
						(Nc)	(Car)			(Nc)	(Car)			(Nc)	(Car)		
Benzo(a)anthracene	N/A	7.3E-01	0.29	4.3E+01	3.9E+01		6.81E-07		5E-07		1.39E-07		1E-07		2.71E-07		2E-07
Benzo(a)pyrene	N/A	7.3E+00	0.29	3.5E+01	3.2E+01		5.56E-07		4E-06		1.12E-07		8E-07		2.21E-07		2E-06
Benzo(b)fluoranthene	N/A	7.3E-01	0.29	2.8E+01	2.6E+01		4.51E-07		3E-07		9.20E-08		7E-08		1.79E-07		1E-07
Benzo(k)fluoranthene	N/A	7.3E-02	0.29	3.6E+01	3.2E+01		5.70E-07		4E-08		1.15E-07		8E-09		2.27E-07		2E-08
Carbazole	N/A	2.0E-02	1	2.6E+01	2.2E+01		1.41E-06		3E-08		2.71E-07		5E-09		5.59E-07		1E-08
Chrysene	N/A	7.3E-03	0.29	4.2E+01	3.8E+01		6.65E-07		5E-09		1.35E-07		1E-09		2.64E-07		2E-09
Dibenz(a,h)anthracene	N/A	7.3E+00	0.29	5.4E+00	5.1E+00		8.63E-08		6E-07		1.81E-08		1E-07		3.43E-08		3E-07
Indeno(1,2,3-cd)pyrene	N/A	7.3E-01	0.29	1.3E+01	1.2E+01		2.05E-07		1E-07		4.15E-08		3E-08		8.14E-08		6E-08
Heptachlor epoxide	1.E-05	9.1E+00	1	2.4E-02	2.2E-02	1.03E-08	1.32E-09	8E-04	1E-08	1.89E-08	2.69E-10	1E-03	2E-09	6.14E-09	5.26E-10	5E-04	5E-09
Arsenic	3.E-04	1.5E+00	1	6.3E+00	6.2E+00	2.70E-06	3.47E-07	9E-03	5E-07	5.31E-06	7.59E-08	2E-02	1E-07	1.61E-06	1.38E-07	5E-03	2E-07
Iron	3.E-01	N/A	1	2.5E+04	2.4E+04	1.06E-02		4E-02		2.09E-02		7E-02		6.34E-03		2E-02	
Total Hazard Quotient and Cancer Risk:								5E-02	6E-06			9E-02	1E-06			3E-02	2E-06
						Assumptions for Industrial Worker			Assumptions for Construction Worker			Assumptions for Child Trespasser					
						CF =	1E-06 kg/mg				CF =	1E-06 kg/mg					
						EPC=	EPC Surface Only				EPC=	EPC Surface and Subsurface					
						BW =	70 kg				BW =	70 kg					
						IR =	50 mg/day				IR =	100 mg/day					
						FI =	1 unitless				FI =	1 unitless					
						EF =	219 days/year				EF =	219 days/year					
						ED =	9 years				ED =	1 years					
						AT (Nc) =	3,285 days				AT (Nc) =	365 days					
						AT (Car) =	25,550 days				AT (Car) =	25,550 days					

Note: Cells in this table were intentionally left blank due to a lack of toxicity data.
NA= Information not available.

**TABLE E-3
CALCULATION OF ABSORBED DOSE AND RISK FROM DERMAL CONTACT TO SOIL
REASONABLE MAXIMUM EXPOSURE (RME) - SEAD-71
SEAD-59 AND SEAD-71 PHASE II RI
Seneca Army Depot Activity**

Equation for Intake (mg/kg-day) =	$\frac{EPC \times CF \times SA \times AF \times ABS \times EV \times EF \times ED}{BW \times AT}$
Variables (Assumptions for Each Receptor are Listed at the Bottom):	Equation for Hazard Quotient = Chronic Daily Intake (Nc)/Reference Dose
EPC = Chemical Concentration in Soil, mg/kg	EV = Event Frequency
CF = Conversion Factor	EF = Exposure Frequency
SA = Surface Area Contact	ED = Exposure Duration
AF = Adherence Factor	BW = Bodyweight
ABS = Absorption Factor	AT = Averaging Time
	Equation for Cancer Risk = Chronic Daily Intake (Car) x Slope Factor

Analyte	Dermal RfD (mg/kg-day)	Carc. Slope Dermal (mg/kg-day)-1	Absorption Factor* (unitless)	EPC Surface Soil (mg/kg)	EPC from Total Soils (mg/kg)	Industrial Worker			Construction Worker			Child Trespasser					
						Absorbed Dose (mg/kg-day)		Hazard Quotient	Cancer Risk	Absorbed Dose (mg/kg-day)		Hazard Quotient	Cancer Risk	Absorbed Dose (mg/kg-day)		Hazard Quotient	Cancer Risk
						(Nc)	(Car)			(Nc)	(Car)			(Nc)	(Car)		
Benzo(a)anthracene	N/A	7.3E-01	1.3E-01	4.3E+01	3.9E+01		1.28E-05		9E-06		7.03E-07		5E-07		6.80E-07		4.96E-07
Benzo(a)pyrene	N/A	7.3E+00	1.3E-01	3.5E+01	3.2E+01		1.04E-05		8E-05		5.68E-07		4E-06		5.55E-07		4.05E-06
Benzo(b)fluoranthene	N/A	7.3E-01	1.3E-01	2.8E+01	2.6E+01		8.46E-06		6E-06		4.66E-07		3E-07		4.50E-07		3.28E-07
Benzo(k)fluoranthene	N/A	7.3E-02	1.3E-01	3.6E+01	3.2E+01		1.07E-05		8E-07		5.81E-07		4E-08		5.70E-07		4.16E-08
Carbazole	N/A	2.0E-02	1.0E-01	2.6E+01	2.2E+01		5.88E-06		1E-07		3.06E-07		6E-09		3.13E-07		6.26E-09
Chrysene	N/A	7.3E-03	1.3E-01	4.2E+01	3.8E+01		1.25E-05		9E-08		6.85E-07		5E-09		6.64E-07		4.85E-09
Dibenz(a,h)anthracene	N/A	7.3E+00	1.3E-01	5.4E+00	5.1E+00		1.62E-06		1E-05		9.17E-08		7E-07		8.62E-08		6.29E-07
Indeno(1,2,3-cd)pyrene	N/A	7.3E-01	1.3E-01	1.3E+01	1.2E+01		3.84E-06		3E-06		2.10E-07		2E-07		2.04E-07		1.49E-07
Heptachlor epoxide	1.E-05	9.1E+00	1.0E-01	2.4E-02	2.2E-02	1.55E-08	5.54E-09	1E-03	5E-08	2.13E-08	3.04E-10	2E-03	3E-09	3.44E-09	2.95E-10	2.64E-04	2.68E-09
Arsenic	3.E-04	1.5E+00	3E-02	6.3E+00	6.2E+00	1.22E-06	4.36E-07	4E-03	7E-07	1.80E-06	2.57E-08	6E-03	4E-08	2.71E-07	2.32E-08	9.02E-04	3.48E-08
Iron	3.E-01	N/A	1E-03	2.5E+04	2.4E+04	1.60E-04		5E-04		2.36E-04		8E-04		3.55E-05		1.18E-04	
Total Hazard Quotient and Cancer Risk:								6E-03	1E-04			8E-03	6E-06			1E-03	6E-06
						Assumptions for Industrial Worker			Assumptions for Construction Worker			Assumptions for Child Trespasser					
						CF =	1E-06 kg/mg			CF =	1E-06 kg/mg			CF =	1E-06 kg/mg		
						CS =	EPC Surface Only			EPC =	EPC Surface and Subsurface			EPC =	EPC Surface Only		
						BW =	70 kg			BW =	70 kg			BW =	15 kg		
						SA =	3,300 cm ²			SA =	3,300 cm ²			SA =	2,800 cm ²		
						AF =	0.2 mg/cm ² -event			AF =	0.3 mg/cm ² -event			AF =	0.2 mg/cm ² -event		
						EV =	1 event/day			EV =	1 event/day			EV =	1 event/day		
						EF =	250 days/year			EF =	250 days/year			EF =	14 days/year		
						ED =	25 years			ED =	1 years			ED =	6 years		
						AT (Nc) =	9,125 days			AT (Nc) =	365 days			AT (Nc) =	2,190 days		
						AT (Car) =	25,550 days			AT (Car) =	25,550 days			AT (Car) =	25,550 days		

Note: Cells in this table were intentionally left blank due to a lack of toxicity data.

NA= Information not available.

* Absorption factors from Exhibit 3-4 of USEPA (2004) Supplemental Guidance for Dermal Risk Assessment, Part E of Risk Assessment Guidance for Superfund, Human Health Evaluation Manual (Volume I).

Absorption factor for iron was assumed to be 0.001 in accordance with the USEPA Region 4 (2000)

Supplemental Guidance to RAGS: Region 4 Bulletins, Human Health Risk Assessment Bulletins (<http://www.epa.gov/region4/waste/ots/healthbul.htm>).

**TABLE E-4
CALCULATION OF ABSORBED DOSE AND RISK FROM DERMAL CONTACT TO SOIL
CENTRAL TENDENCY (CT) - SEAD-71
SEAD-59 AND SEAD-71 PHASE II RI
Seneca Army Depot Activity**

Equation for Intake (mg/kg-day) =	$\frac{EPC \times CF \times SA \times AF \times ABS \times EV \times EF \times ED}{BW \times AT}$	Equation for Hazard Quotient = Chronic Daily Intake (Nc)/Reference Dose
Variables (Assumptions for Each Receptor are Listed at the Bottom):	EV = Event Frequency EF = Exposure Frequency ED = Exposure Duration BW = Bodyweight AT = Averaging Time	Equation for Cancer Risk = Chronic Daily Intake (Car) x Slope Factor
EPC = Chemical Concentration in Soil, mg/kg		
CF = Conversion Factor		
SA = Surface Area Contact		
AF = Adherence Factor		
ABS = Absorption Factor		

Analyte	Dermal RfD (mg/kg-day)	Carc. Slope Dermal (mg/kg-day)-1	Absorption Factor* (unitless)	EPC Surface Soil (mg/kg)	EPC from Total Soils (mg/kg)	Industrial Worker			Construction Worker			Child Trespasser					
						Absorbed Dose (mg/kg-day)		Hazard Quotient	Cancer Risk	Absorbed Dose (mg/kg-day)		Hazard Quotient	Cancer Risk	Absorbed Dose (mg/kg-day)		Hazard Quotient	Cancer Risk
						(Nc)	(Car)			(Nc)	(Car)			(Nc)	(Car)		
Benzo(a)anthracene	N/A	7.3E-01	1.3E-01	4.3E+01	3.9E+01		4.03E-07		3E-07		6.16E-07		4E-07		1.36E-07		9.92E-08
Benzo(a)pyrene	N/A	7.3E+00	1.3E-01	3.5E+01	3.2E+01		3.29E-07		2E-06		4.98E-07		4E-06		1.11E-07		8.11E-07
Benzo(b)fluoranthene	N/A	7.3E-01	1.3E-01	2.8E+01	2.6E+01		2.67E-07		2E-07		4.08E-07		3E-07		9.00E-08		6.57E-08
Benzo(k)fluoranthene	N/A	7.3E-02	1.3E-01	3.6E+01	3.2E+01		3.38E-07		2E-08		5.09E-07		4E-08		1.14E-07		8.32E-09
Carbazole	N/A	2.0E-02	1E-01	2.6E+01	2.2E+01		1.85E-07		4E-09		2.68E-07		5E-09		6.26E-08		1.25E-09
Chrysene	N/A	7.3E-03	1.3E-01	4.2E+01	3.8E+01		3.93E-07		3E-09		6.00E-07		4E-09		1.33E-07		9.69E-10
Dibenz(a,h)anthracene	N/A	7.3E+00	1.3E-01	5.4E+00	5.1E+00		5.11E-08		4E-07		8.04E-08		6E-07		1.72E-08		1.26E-07
Indeno(1,2,3-cd)pyrene	N/A	7.3E-01	1.3E-01	1.3E+01	1.2E+01		1.21E-07		9E-08		1.84E-07		1E-07		4.08E-08		2.98E-08
Heptachlor epoxide	1.E-05	9.1E+00	1E-01	2.4E-02	2.2E-02	1.36E-09	1.75E-10	1E-04	2E-09	1.87E-08	2.67E-10	1E-03	2E-09	6.87E-10	5.89E-11	5.29E-05	5.36E-10
Arsenic	3.E-04	1.5E+00	3.0E-02	6.3E+00	6.2E+00	1.07E-07	1.37E-08	4E-04	2E-08	1.58E-06	2.25E-08	5E-03	3E-08	5.41E-08	4.64E-09	2E-04	7E-09
Iron	3.E-01	N/A	1E-03	2.5E+04	2.4E+04	1.40E-05		5E-05		2.07E-04		7E-04		7.10E-06		2E-05	
Total Hazard Quotient and Cancer Risk:								5E-04	3E-06			7E-03	5E-06			3E-04	1E-06
						Assumptions for Industrial Worker			Assumptions for Construction Worker			Assumptions for Child Trespasser					
						CF =	1E-06 kg/mg			CF =	1E-06 kg/mg			CF =	1E-06 kg/mg		
						CS =	EPC Surface Only			EPC =	EPC Surface and Subsurface			EPC =	EPC Surface Only		
						BW =	70 kg			BW =	70 kg			BW =	15 kg		
						SA =	3,300 cm ²			SA =	3,300 cm ²			SA =	2,800 cm ²		
						AF =	0.02 mg/cm ² -event			AF =	0.3 mg/cm ² -event			AF =	0.04 mg/cm ² -event		
						EV =	1 event/day			EV =	1 event/day			EV =	1 event/day		
						EF =	219 days/year			EF =	219 days/year			EF =	14 days/year		
						ED =	9 years			ED =	1 years			ED =	6 years		
						AT (Nc) =	3,285 days			AT (Nc) =	365 days			AT (Nc) =	2,190 days		
						AT (Car) =	25,550 days			AT (Car) =	25,550 days			AT (Car) =	25,550 days		

Note: Cells in this table were intentionally left blank due to a lack of toxicity data.

NA= Information not available.

* Absorption factors from Exhibit 3-4 of USEPA (2004) Supplemental Guidance for Dermal Risk Assessment, Part E of Risk Assessment Guidance for Superfund, Human Health Evaluation Manual (Volume I).

Absorption factor for iron was assumed to be 0.001 in accordance with the USEPA Region 4 (2000)

Supplemental Guidance to RAGS: Region 4 Bulletins, Human Health Risk Assessment Bulletins (<http://www.epa.gov/region4/waste/ots/healthbul.htm>).

TABLE E-5
CALCULATION OF INTAKE AND RISK FROM INHALATION OF DUST IN AMBIENT AIR
REASONABLE MAXIMUM EXPOSURE (RME) - SEAD-71
SEAD-59 AND SEAD-71 PHASE II RI
Seneca Army Depot Activity

Equation for Intake (mg/kg-day) = $\frac{EPC \times IR \times EF \times ED}{BW \times AT}$ Variables (Assumptions for Each Receptor are Listed at the Bottom): EPC = Exposure Point Concentration in Air, mg/m ³ ED = Exposure Duration IR = Inhalation Rate BW = Bodyweight EF = Exposure Frequency AT = Averaging Time	Equation for Hazard Quotient = Chronic Daily Intake (Nc)/Reference Dose Equation for Cancer Risk = Chronic Daily Intake (Car) x Slope Factor
---	---

Analyte	Inhalation RID (mg/kg-day)	Carc. Slope Inhalation (mg/kg-day)-1	Air EPC from Surface Soil (mg/m ³)	Air EPC from Total Soils (mg/m ³)	Industrial Worker			Construction Worker			Child Trespasser					
					Intake (mg/kg-day)		Hazard Quotient	Cancer Risk	Intake (mg/kg-day)		Hazard Quotient	Cancer Risk	Intake (mg/kg-day)		Hazard Quotient	Cancer Risk
					(Nc)	(Car)			(Nc)	(Car)			(Nc)	(Car)		
Benzo(a)anthracene	N/A	N/A	7.2E-07	3.7E-05												
Benzo(a)pyrene	N/A	3.1E+00	5.9E-07	3.0E-05		4.13E-08			1E-07		8.43E-08			3E-07		5E-09
Benzo(b)fluoranthene	N/A	N/A	4.8E-07	2.5E-05												
Benzo(k)fluoranthene	N/A	N/A	6.1E-07	3.1E-05												
Carbazole	N/A	N/A	4.3E-07	2.1E-05												
Chrysene	N/A	N/A	7.1E-07	3.6E-05												
Dibenz(a,h)anthracene	N/A	N/A	9.2E-08	4.9E-06												
Indeno(1,2,3-cd)pyrene	N/A	N/A	2.2E-07	1.1E-05												
Heptachlor epoxide	N/A	9.1E+00	4.1E-10	2.1E-08		2.85E-11			3E-10		5.87E-11			5E-10		1E-11
Arsenic	N/A	1.5E+01	1.1E-07	5.9E-06		7.49E-09			1E-07		1.65E-08			2E-07		4E-09
Iron	N/A	N/A	4.2E-04	2.3E-02												
Total Hazard Quotient and Cancer Risk:									2E-07					5E-07		9E-09
					Assumptions for Industrial Worker			Assumptions for Construction Worker			Assumptions for Child Trespasser					
					CA =	EPC Surface Only		CA =	EPC Surface and Sub-Surface		CA =	EPC Surface Only				
					BW =	70 kg		BW =	70 kg		BW =	15 kg				
					IR =	20 m ³ /day		IR =	20 m ³ /day		IR =	12 m ³ /day				
					EF =	250 days/year		EF =	250 days/year		EF =	14 days/year				
					ED =	25 years		ED =	1 year		ED =	6 years				
					AT (Nc) =	9,125 days		AT (Nc) =	365 days		AT (Nc) =	2,190 days				
					AT (Car) =	25,550 days		AT (Car) =	25,550 days		AT (Car) =	25,550 days				

Note: Cells in this table were intentionally left blank due to a lack of toxicity data.
 NA= Information not available.

TABLE E-6
CALCULATION OF INTAKE AND RISK FROM INHALATION OF DUST IN AMBIENT AIR
CENTRAL TENDENCY EXPOSURE (CT) - SEAD-71
SEAD-59 AND SEAD-71 PHASE II RI
Seneca Army Depot Activity

Equation for Intake (mg/kg-day) = $\frac{EPC \times IR \times EF \times ED}{BW \times AT}$ Variables (Assumptions for Each Receptor are Listed at the Bottom): EPC = Exposure Point Concentration, mg/m ³ ED = Exposure Duration IR = Inhalation Rate BW = Bodyweight EF = Exposure Frequency AT = Averaging Time	Equation for Hazard Quotient = Chronic Daily Intake (Nc)/Reference Dose Equation for Cancer Risk = Chronic Daily Intake (Car) x Slope Factor
--	---

Analyte	Inhalation RID (mg/kg-day)	Carc. Slope Inhalation (mg/kg-day)-1	Air EPC from Surface Soil (mg/m ³)	Air EPC from Total Soils (mg/m ³)	Industrial Worker			Construction Worker			Child Trespasser					
					Intake (mg/kg-day)		Hazard Quotient	Cancer Risk	Intake (mg/kg-day)		Hazard Quotient	Cancer Risk	Intake (mg/kg-day)		Hazard Quotient	Cancer Risk
					(Nc)	(Car)			(Nc)	(Car)			(Nc)	(Car)		
Benzo(a)anthracene	N/A	N/A	7.24E-07	3.73E-05												
Benzo(a)pyrene	N/A	3.10E+00	5.92E-07	3.01E-05		6.78E-09				7.38E-08		2E-07		1.56E-09	5E-09	
Benzo(b)fluoranthene	N/A	N/A	4.79E-07	2.47E-05												
Benzo(k)fluoranthene	N/A	N/A	6.07E-07	3.08E-05												
Carbazole	N/A	N/A	4.34E-07	2.11E-05												
Chrysene	N/A	N/A	7.07E-07	3.63E-05												
Dibenz(a,h)anthracene	N/A	N/A	9.18E-08	4.87E-06												
Indeno(1,2,3-cd)pyrene	N/A	N/A	2.18E-07	1.12E-05												
Heptachlor epoxide	N/A	9.10E+00	4.08E-10	2.10E-08		4.68E-12		4E-11		5.14E-11		5E-10		1.07E-12	1E-11	
Arsenic	N/A	1.51E+01	1.07E-07	5.91E-06		1.23E-09		2E-08		1.45E-08		2E-07		2.82E-10	4E-09	
Iron	N/A	N/A	4.21E-04	2.33E-02												
Total Hazard Quotient and Cancer Risk:								4E-08				4E-07			9E-09	
					Assumptions for Industrial Worker			Assumptions for Construction Worker			Assumptions for Child Trespasser					
					CA =	EPC Surface Only		CA =	EPC Surface and Sub-Surface		CA =	EPC Surface Only				
					BW =	70 kg		BW =	70 kg		BW =	15 kg				
					IR =	10.4 m ³ /day		IR =	20 m ³ /day		IR =	12 m ³ /day				
					EF =	219 days/year		EF =	219 days/year		EF =	14 days/year				
					ED =	9 years		ED =	1 year		ED =	6 years				
					AT (Nc) =	3,285 days		AT (Nc) =	365 days		AT (Nc) =	2,190 days				
					AT (Car) =	25,550 days		AT (Car) =	25,550 days		AT (Car) =	25,550 days				

Note: Cells in this table were intentionally left blank due to a lack of toxicity data.
 NA= Information not available.

**TABLE E-7
CALCULATION OF ABSORBED DOSE AND RISK FROM DERMAL CONTACT TO GROUNDWATER
REASONABLE MAXIMUM EXPOSURE (RME) - SEAD-71
SEAD-59 AND SEAD-71 PHASE II RI
Seneca Army Depot Activity**

Equation for Dermal (mg/kg-day) = $\frac{DA \times SA \times EF \times ED \times EV}{BW \times AT}$	Equation for Absorbed Dose per Event (DA): For inorganics: $DA = Kp \times EPC \times t_{event} \times CF$ For organics: If $t_{event} < t^*$, then: $DA_{event} = 2 FA \times K_p \times EPC \left(\frac{6 t_{event} \times t_{event}}{\pi} \right)^{1/2}$ If $t_{event} > t^*$, then: $DA_{event} = FA \times K_p \times EPC \left[\frac{t_{event}}{1+B} + 2 t_{event} \left(\frac{1+3B+3B^2}{(1+B)^2} \right) \right]$ B = Dimensionless ratio of the permeability coefficient of a compound through the stratum corneum relative to its permeability coefficient across the viable epidermis (ve) (dimensionless) FA = Fraction absorbed water (dimensionless) $t^* = 2.4 \times B$ $t_{event} = \text{Lag Time per event (hr/event)}$ $t^* = \text{Time to reach steady-state (hr)}$	$Kp = \text{Permeability Coefficient, cm/hr}$ $EPC = \text{EPC in Groundwater, mg/L}$ $CF = \text{Conversion Factor, } 10^3 \text{ L/cm}^3$ If $B \leq 0.6$, then $t^* = 2.4 t_{event}$ If $B > 0.6$, then $t^* = 6 t_{event} (b - \sqrt{b^2 - c^2})$ $b = \frac{2(1+B)^2}{\pi} - c$ $c = \frac{1+3B+3B^2}{3(1+B)}$ $t_{event} = 0.105 \times 10^{(0.0056MW)}$	Equation for Hazard Quotient = Chronic Daily Intake (NC)/Reference Dose Equation for Cancer Risk = Chronic Daily Intake (Car) x Slope Factor
---	---	---	---

Analyte	Dermal RfD (mg/kg-day)	Carc. Slope Dermal (mg/kg-day) ⁻¹	Permeability Coefficient Kp (cm/hr)	τ _{event} (hr/event)	Fraction Absorbed Water	B	t* (hour)	EPC Ground Water (mg/L)	Absorbed Dose/Event (mg-cm ³ /event)	Industrial Worker			Construction Worker			Child Trespasser					
										Intake (mg/kg-day)		Hazard Quotient	Cancer Risk	Intake (mg/kg-day)		Hazard Quotient	Cancer Risk	Intake (mg/kg-day)		Hazard Quotient	Cancer Risk
										(Nc)	(Car)			(Nc)	(Car)			(Nc)	(Car)		
Semivolatile Organic 4-Nitroaniline	3.E-03	2.0E-02	2.7E-03	0.6	1.0	1.2E-02	2.9E-02	8.7E-03	3.6E-08	Dermal Contact to Ground Water Not Applicable for Industrial Worker			3.48E-07	4.97E-09	1E-04	1E-10	Dermal Contact to Ground Water Not Applicable for Child Trespasser				
Metals Arsenic	3.E-04	1.5E+00	1.0E-03					2.7E-03	1.4E-09	Dermal Contact to Ground Water Not Applicable for Industrial Worker			1.32E-08	1.88E-10	4E-05	3E-10	Dermal Contact to Ground Water Not Applicable for Child Trespasser				
Iron	3.E-01	N/A	1.0E-03					3.5E+01	1.8E-05	Dermal Contact to Ground Water Not Applicable for Industrial Worker			1.71E-04		6E-04		Dermal Contact to Ground Water Not Applicable for Child Trespasser				
Manganese	2.E-02	N/A	1.0E-03					2.7E+00	1.3E-06	Dermal Contact to Ground Water Not Applicable for Industrial Worker			1.31E-05		6E-04		Dermal Contact to Ground Water Not Applicable for Child Trespasser				
Thallium	6.E-04	N/A	1.0E-03					2.5E-03	1.3E-09	Dermal Contact to Ground Water Not Applicable for Industrial Worker			1.22E-08		2E-05		Dermal Contact to Ground Water Not Applicable for Child Trespasser				
Total Hazard Quotient and Cancer Risk:															1E-03	4E-10					
										Assumptions for Construction Worker BW = 70 kg SA = 2,490 cm ² EV = 1 event/day EF = 100 days/year ED = 1 years t _{event} = 0.5 hr/event AT (Nc) = 365 days AT (Car) = 25,550 days											

Note: Cells in this table were intentionally left blank due to a lack of toxicity data
NA= Information not available

**TABLE E-8
CALCULATION OF ABSORBED DOSE AND RISK FROM DERMAL CONTACT TO GROUNDWATER
CENTRAL TENDENCY (CT) - SEAD-71
SEAD-59 AND SEAD-71 PHASE II RI
Seneca Army Depot Activity**

Equation for Dermal (mg/kg-day) = $\frac{DA \times SA \times EF \times ED \times EV}{BW \times AT}$	Equation for Absorbed Dose per Event (DA): For inorganics: $DA = Kp \times EPC \times t_{event} \times CF$ For organics: If $t_{event} \leq t^*$, then: $DA_{event} = 2 \times FA \times K_p \times EPC \times ((6 \times t_{event} \times t_{event}) / \pi)^{1/2}$ if $t_{event} > t^*$, then: $DA_{event} = FA \times K_p \times EPC \times [(t_{event} / (1 + B)) + 2 \times t_{event} \times ((1 + 3B + 3B^2) / (1 + B)^2)]$ B = Dimensionless ratio of the permeability coefficient of a compound through the stratum corneum relative to its permeability coefficient across the viable epidermis (ve) (dimensionless) FA = Fraction absorbed water (dimensionless) $t^* = 2.4 \times B$ $t_{event} = \text{Lag Time per event (hr/event)}$ $t^* = \text{Time to reach steady-state (hr)}$	Kp = Permeability Coefficient, cm/hr EPC = EPC in Groundwater, mg/L CF = Conversion Factor, 10^3 L/cm^3 $b = \frac{2(1-B)^2}{\pi} - c$ $c = \frac{1 + 3B + 3B^2}{3(1 + B)}$ $\tau_{event} = 0.105 \times 10^{(0.0056/MW)}$	Equation for Hazard Quotient = Chronic Daily Intake (Nc)/Reference Dose Equation for Cancer Risk = Chronic Daily Intake (Car) x Slope Factor
---	---	---	---

Analyte	Dermal RfD (mg/kg-day)	Carc. Slope Dermal (mg/kg-day)-1	Permeability Coefficient K_p (cm/hr)	τ_{event} (hr/event)	Fraction Absorbed Water	B	t^* (hour)	EPC Ground Water (mg/L)	Absorbed Dose/Event (mg-cm ³ /event)	Industrial Worker			Construction Worker			Child Trespasser					
										Intake (mg/kg-day)		Hazard Quotient	Cancer Risk	Intake (mg/kg-day)		Hazard Quotient	Cancer Risk	Intake (mg/kg-day)		Hazard Quotient	Cancer Risk
										(Nc)	(Car)			(Nc)	(Car)			(Nc)	(Car)		
Semivolatile Organic 4-Nitroaniline	3.E-03	2.0E-02	2.7E-03	0.6	1.0	1.2E-02	2.9E-02	8.7E-03	3.6E-08	Dermal Contact to Ground Water Not Applicable for Industrial Worker			2.76E-07	3.95E-09	9E-05	8E-11	Dermal Contact to Ground Water Not Applicable for Child Trespasser				
Metals Arsenic	3.E-04	1.5E+00	1.0E-03					2.7E-03	1.4E-09	Dermal Contact to Ground Water Not Applicable for Industrial Worker			1.05E-08	1.49E-10	3E-05	2E-10	Dermal Contact to Ground Water Not Applicable for Child Trespasser				
Iron	3.E-01	N/A	1.0E-03					3.5E+01	1.8E-05	Dermal Contact to Ground Water Not Applicable for Industrial Worker			1.36E-04		5E-04		Dermal Contact to Ground Water Not Applicable for Child Trespasser				
Manganese	2.E-02	N/A	1.0E-03					2.7E+00	1.3E-06	Dermal Contact to Ground Water Not Applicable for Industrial Worker			1.04E-05		4E-04		Dermal Contact to Ground Water Not Applicable for Child Trespasser				
Thallium	6.E-04	N/A	1.0E-03					2.5E-03	1.3E-09	Dermal Contact to Ground Water Not Applicable for Industrial Worker			9.69E-09		1E-05		Dermal Contact to Ground Water Not Applicable for Child Trespasser				
Total Hazard Quotient and Cancer Risk:															1E-03	3E-10					
										Assumptions for Construction Worker BW = 70 kg SA = 1,980 cm ² EV = 1 event/day EF = 100 days/year ED = 1 years t _{event} = 0.5 hr/event AT (Nc) = 365 days AT (Car) = 25,550 days											

Note: Cells in this table were intentionally left blank due to a lack of toxicity data
NA= Information not available

TABLE E-9
CALCULATION OF INTAKE AND RISK FROM THE INTAKE OF GROUNDWATER
REASONABLE MAXIMUM EXPOSURE (RME) - SEAD-71
SEAD-59 AND SEAD-71 PHASE II RI
Seneca Army Depot Activity

Equation for Intake (mg/kg-day) = $\frac{EPC \times IR \times EF \times ED}{BW \times AT}$	Equation for Hazard Quotient = Chronic Daily Intake (Nc)/Reference Dose
Variables (Assumptions for Each Receptor are Listed at the Bottom): EPC = Exposure Point Concentration in Groundwater, mg/L IR = Ingestion Rate EF = Exposure Frequency	Equation for Cancer Risk = Chronic Daily Intake (Car) x Slope Factor
ED=Exposure Duration BW=Bodyweight AT=Averaging Time	

Analyte	Oral RfD (mg/kg-day)	Carc. Slope Oral (mg/kg-day) ⁻¹	EPC Groundwater (mg/liter)	Industrial Worker				Construction Worker				Child Trespasser			
				Intake (mg/kg-day)		Hazard Quotient	Cancer Risk	Intake (mg/kg-day)		Hazard Quotient	Cancer Risk	Intake (mg/kg-day)		Hazard Quotient	Cancer Risk
				(Nc)	(Car)			(Nc)	(Car)			(Nc)	(Car)		
4-Nitroaniline	3.E-03	2.0E-02	0.0087	8.51E-05	3.04E-05	3E-02	6E-07	8.51E-05	1.22E-06	3E-02	2E-08	3.34E-05	2.86E-06	1.11E-02	5.72E-08
Arsenic	3.E-04	1.5E+00	0.0027	2.64E-05	9.44E-06	9E-02	1E-05	2.64E-05	3.77E-07	9E-02	6E-07	1.04E-05	8.88E-07	3.45E-02	1.33E-06
Iron	3.E-01	N/A	35.1	3.43E-01	1.23E-01	1E+00		3.43E-01	4.91E-03	1E+00		1.35E-01	1.15E-02	4.49E-01	
Manganese	2.E-02	N/A	2.68	2.62E-02	9.37E-03	1E+00		2.62E-02	3.75E-04	1E+00		1.03E-02	8.81E-04	4.41E-01	
Thallium	6.E-04	N/A	0.0025	2.45E-05	8.74E-06	4E-02		2.45E-05	3.49E-07	4E-02		9.59E-06	8.22E-07	1.48E-02	
Total Hazard Quotient and Cancer Risk:						2E+00	1E-05			2E+00	6E-07			9E-01	1E-06
				Assumptions for Industrial Worker				Assumptions for Construction Worker				Assumptions for Child Trespasser			
				BW =	70 kg	IR =	1 liters/day	BW =	70 kg	IR =	1 liters/day	BW =	15 kg	IR =	1.5 liters/day
				EF =	250 days/year	EF =	250 days/year	EF =	250 days/year	EF =	14 days/year	EF =	14 days/year	ED =	6 years
				ED =	25 years	ED =	1 years	ED =	1 years	ED =	6 years	ED =	6 years	AT (Nc) =	2,190 days
				AT (Nc) =	9,125 days	AT (Nc) =	365 days	AT (Nc) =	365 days	AT (Nc) =	365 days	AT (Nc) =	2,190 days	AT (Car) =	25,550 days
				AT (Car) =	25,550 days	AT (Car) =	25,550 days	AT (Car) =	25,550 days	AT (Car) =	25,550 days	AT (Car) =	25,550 days		

Note: Cells in this table were intentionally left blank due to a lack of toxicity data.
NA= Information not available.

TABLE E-10
CALCULATION OF INTAKE AND RISK FROM THE INTAKE OF GROUNDWATER
CENTRAL TENDENCY (CT) - SEAD-71
SEAD-59 AND SEAD-71 PHASE II RI
Seneca Army Depot Activity

<p>Equation for Intake (mg/kg-day) = $\frac{EPC \times IR \times EF \times ED}{BW \times AT}$</p> <p>Variables (Assumptions for Each Receptor are Listed at the Bottom): EPC = Chemical Concentration in Groundwater (mg/L) IR = Ingestion Rate EF = Exposure Frequency</p>	<p>Equation for Hazard Quotient = Chronic Daily Intake (Nc)/Reference Dose</p> <p>Equation for Cancer Risk = Chronic Daily Intake (Car) x Slope Factor</p> <p>ED=Exposure Duration BW=Bodyweight AT=Averaging Time</p>
---	--

Analyte	Oral RfD (mg/kg-day)	Carc. Slope Oral (mg/kg-day)-1	EPC Groundwater (mg/liter)	Industrial Worker			Construction Worker			Child Trespasser					
				Intake (mg/kg-day)		Hazard Quotient	Cancer Risk	Intake (mg/kg-day)		Hazard Quotient	Cancer Risk	Intake (mg/kg-day)		Hazard Quotient	Cancer Risk
				(Nc)	(Car)			(Nc)	(Car)			(Nc)	(Car)		
4-Nitroaniline	3.E-03	2.0E-02	0.0087	5.22E-05	6.71E-06	2E-02	1E-07	5.22E-05	7.46E-07	2E-02	1E-08	1.65E-05	1.41E-06	5.49E-03	2.82E-08
Arsenic	3.E-04	1.5E+00	0.0027	1.62E-05	2.08E-06	5E-02	3E-06	1.62E-05	2.31E-07	5E-02	3E-07	5.11E-06	4.38E-07	1.70E-02	6.57E-07
Iron	3.E-01	N/A	35.1	2.11E-01	2.71E-02	7E-01		2.11E-01	3.01E-03	7E-01		6.64E-02	5.69E-03	2.21E-01	
Manganese	2.E-02	N/A	2.68	1.61E-02	2.07E-03	7E-01		1.61E-02	2.30E-04	7E-01		5.07E-03	4.35E-04	2.17E-01	
Thallium	6.E-04	N/A	0.0025	1.50E-05	1.93E-06	2E-02		1.50E-05	2.14E-07	2E-02		4.73E-06	4.05E-07	7.32E-03	
Total Hazard Quotient and Cancer Risk:						1E+00	3E-06			1E+00	4E-07			5E-01	7E-07
				Assumptions for Industrial Worker			Assumptions for Construction Worker			Assumptions for Child Trespasser					
				BW =	70 kg	BW =	70 kg	BW =	15 kg						
				IR =	0.7 liters/day	IR =	0.7 liters/day	IR =	0.74 liters/day						
				EF =	219 days/year	EF =	219 days/year	EF =	14 days/year						
				ED =	9 years	ED =	1 years	ED =	6 years						
				AT (Nc) =	3,285 days	AT (Nc) =	365 days	AT (Nc) =	2,190 days						
				AT (Car) =	25,550 days	AT (Car) =	25,550 days	AT (Car) =	25,550 days						

Note: Cells in this table were intentionally left blank due to a lack of toxicity data.
NA= Information not available.

Table E-11
Calculations of Blood Lead Concentration - Industrial Worker Exposed to SEAD-71 Surface Soil
SEAD-59 and SEAD-71 Phase II RI
Seneca Army Depot Activity

Calculations of Blood Lead Concentrations (PbBs)
 U.S. EPA Technical Review Workgroup for Lead, Adult Lead Committee

Version date 05/19/03



Exposure Variable	PbB Equation ¹		Description of Exposure Variable	Units	Values for Non-Residential Exposure Scenario			
	1*	2**			Using Equation 1		Using Equation 2	
					GSDi = Hom	GSDi = Het	GSDi = Hom	GSDi = Het
PbS	X	X	Soil lead concentration	ug/g or ppm	166.3	166.3	166.3	166.3
R _{fetal/maternal}	X	X	Fetal/maternal PbB ratio	--	0.9	0.9	0.9	0.9
BKSF	X	X	Biokinetic Slope Factor	ug/dL per ug/day	0.4	0.4	0.4	0.4
GSD _i	X	X	Geometric standard deviation PbB	--	1.9	2.1	1.9	2.1
PbB ₀	X	X	Baseline PbB	ug/dL	1.7	2.2	1.7	2.2
IR _S	X		Soil ingestion rate (including soil-derived indoor dust)	g/day	0.050	0.050	--	--
IR _{S+D}		X	Total ingestion rate of outdoor soil and indoor dust	g/day	--	--	0.050	0.050
W _S		X	Weighting factor; fraction of IR _{S+D} ingested as outdoor soil	--	--	--	1.0	1.0
K _{SD}		X	Mass fraction of soil in dust	--	--	--	0.7	0.7
AF _{S,D}	X	X	Absorption fraction (same for soil and dust)	--	0.12	0.12	0.12	0.12
EF _{S,D}	X	X	Exposure frequency (same for soil and dust)	days/yr	219	219	219	219
AT _{S,D}	X	X	Averaging time (same for soil and dust)	days/yr	365	365	365	365
PbB_{adult}	PbB of adult worker, geometric mean			ug/dL	1.9	2.4	1.9	2.4
PbB_{fetal, 0.95}	95th percentile PbB among fetuses of adult workers			ug/dL	5.0	7.4	5.0	7.4
PbB_t	Target PbB level of concern (e.g., 10 ug/dL)			ug/dL	10.0	10.0	10.0	10.0
P(PbB_{fetal} > PbB_t)	Probability that fetal PbB > PbB_t, assuming lognormal distribution			%	0.3%	2.1%	0.3%	2.1%

¹ Equation 1 does not apportion exposure between soil and dust ingestion (excludes W_S, K_{SD}).
 When IR_S = IR_{S+D} and W_S = 1.0, the equations yield the same PbB_{fetal,0.95}.

***Equation 1, based on Eq. 1, 2 in USEPA (1996).**

PbB_{adult} =	$(PbS * BKSF * IR_{S+D} * AF_{S,D} * EF_S / AT_{S,D}) + PbB_0$
PbB_{fetal, 0.95} =	$PbB_{adult} * (GSD_i^{1.645} * R)$

****Equation 2, alternate approach based on Eq. 1, 2, and A-19 in USEPA (1996).**

PbB_{adult} =	$PbS * BKSF * ((IR_{S+D}) * AF_S * EF_S * W_S) + [K_{SD} * (IR_{S+D}) * (1 - W_S) * AF_D * EF_D] / 365 + PbB_0$
PbB_{fetal, 0.95} =	$PbB_{adult} * (GSD_i^{1.645} * R)$

Source: U.S. EPA (1996). Recommendations of the Technical Review Workgroup for Lead for an Interim Approach to Assessing Risks Associated with Adult Exposures to Lead in Soil

Table E-12
Calculations of Blood Lead Concentration - Construction Worker Exposed to SEAD-71 Surface and Subsurface Soil
SEAD-59 and SEAD-71 Phase II RI
Seneca Army Depot Activity

Calculations of Blood Lead Concentrations (PbBs)

U.S. EPA Technical Review Workgroup for Lead, Adult Lead Committee

Version date 05/19/03



Exposure Variable	PbB Equation ¹		Description of Exposure Variable	Units	Values for Non-Residential Exposure Scenario			
	1*	2**			Using Equation 1		Using Equation 2	
					GSDi = Hom	GSDi = Het	GSDi = Hom	GSDi = Het
PbS	X	X	Soil lead concentration	ug/g or ppm	152.4	152.4	152.4	152.4
R _{fetal/maternal}	X	X	Fetal/maternal PbB ratio	--	0.9	0.9	0.9	0.9
BKSF	X	X	Biokinetic Slope Factor	ug/dL per ug/day	0.4	0.4	0.4	0.4
GSD _i	X	X	Geometric standard deviation PbB	--	1.9	2.1	1.9	2.1
PbB ₀	X	X	Baseline PbB	ug/dL	1.7	2.2	1.7	2.2
IR _S	X		Soil ingestion rate (including soil-derived indoor dust)	g/day	0.100	0.100	--	--
IR _{S+D}		X	Total ingestion rate of outdoor soil and indoor dust	g/day	--	--	0.100	0.100
W _S		X	Weighting factor; fraction of IR _{S+D} ingested as outdoor soil	--	--	--	1.0	1.0
K _{SD}		X	Mass fraction of soil in dust	--	--	--	0.7	0.7
AF _{S,D}	X	X	Absorption fraction (same for soil and dust)	--	0.12	0.12	0.12	0.12
EF _{S,D}	X	X	Exposure frequency (same for soil and dust)	days/yr	219	219	219	219
AT _{S,D}	X	X	Averaging time (same for soil and dust)	days/yr	365	365	365	365
PbB_{adult}	PbB of adult worker, geometric mean			ug/dL	2.1	2.6	2.1	2.6
PbB_{fetal, 0.95}	95th percentile PbB among fetuses of adult workers			ug/dL	5.5	8.0	5.5	8.0
PbB_t	Target PbB level of concern (e.g., 10 ug/dL)			ug/dL	10.0	10.0	10.0	10.0
P(PbB_{fetal} > PbB_t)	Probability that fetal PbB > PbB_t, assuming lognormal distribution			%	0.5%	2.6%	0.5%	2.6%

Equation 1 does not apportion exposure between soil and dust ingestion (excludes W_S, K_{SD}).
 When IR_S = IR_{S+D} and W_S = 1.0, the equations yield the same PbB_{fetal,0.95}.

***Equation 1, based on Eq. 1, 2 in USEPA (1996).**

PbB_{adult} =	$(PbS * BKSF * IR_{S+D} * AF_{S,D} * EF_{S,D} / AT_{S,D}) + PbB_0$
PbB_{fetal, 0.95} =	$PbB_{adult} * (GSD_i^{1.645} * R)$

****Equation 2, alternate approach based on Eq. 1, 2, and A-19 in USEPA (1996).**

PbB_{adult} =	$PbS * BKSF * [(IR_{S+D}) * AF_S * EF_S * W_S] + [K_{SD} * (IR_{S+D}) * (1 - W_S) * AF_D * EF_D] / 365 + PbB_0$
PbB_{fetal, 0.95} =	$PbB_{adult} * (GSD_i^{1.645} * R)$

Source: U.S. EPA (1996). Recommendations of the Technical Review Workgroup for Lead for an Interim Approach to Assessing Risks Associated with Adult Exposures to Lead in Soil

SEAD71_Lead_I EUBK

Table E-13

Calculation of Blood Lead Concentration - Child Exposed to
SEAD-71 Surface Soil and Groundwater

SEAD-59 and SEAD-71 Phase II RI

Seneca Army Depot Activity

LEAD MODEL FOR WINDOWS Version 1.0

```
=====
Model Version: 1.0 Build 261
User Name:
Date:
Site Name:
Operable Unit:
Run Mode: Research
=====
```

The time step used in this model run: 1 - Every 4 Hours (6 times a day).

***** Air *****

Indoor Air Pb Concentration: 30.000 percent of outdoor.
Other Air Parameters:

Age	Time Outdoors (hours)	Ventilation Rate (m ³ /day)	Lung Absorption (%)	Outdoor Air Pb Conc (ug Pb/m ³)
.5-1	1.000	2.000	32.000	0.100
1-2	2.000	3.000	32.000	0.100
2-3	3.000	5.000	32.000	0.100
3-4	4.000	5.000	32.000	0.100
4-5	4.000	5.000	32.000	0.100
5-6	4.000	7.000	32.000	0.100
6-7	4.000	7.000	32.000	0.100

***** Diet *****

Age	Diet Intake(ug/day)
.5-1	5.530
1-2	5.780
2-3	6.490
3-4	6.240
4-5	6.010
5-6	6.340
6-7	7.000

***** Drinking Water *****

Water Consumption:

Age	Water (L/day)
.5-1	0.200
1-2	0.500
2-3	0.520
3-4	0.530
4-5	0.550
5-6	0.580
6-7	0.590

Drinking Water Concentration: 17.200 ug Pb/L

SEAD71_Lead_I EUBK

***** Soil & Dust *****

Multiple Source Analysis Used

Average multiple source concentration: 126.410 ug/g

Mass fraction of outdoor soil to indoor dust conversion factor: 0.700

Outdoor airborne lead to indoor household dust lead concentration: 100.000

Use alternate indoor dust Pb sources? No

Age	Soil (ug Pb/g)	House Dust (ug Pb/g)
.5-1	166.300	126.410
1-2	166.300	126.410
2-3	166.300	126.410
3-4	166.300	126.410
4-5	166.300	126.410
5-6	166.300	126.410
6-7	166.300	126.410

***** Alternate Intake *****

Age	Alternate (ug Pb/day)
.5-1	0.000
1-2	0.000
2-3	0.000
3-4	0.000
4-5	0.000
5-6	0.000
6-7	0.000

***** Maternal Contribution: Infant Model *****

Maternal Blood Concentration: 2.500 ug Pb/dL

CALCULATED BLOOD LEAD AND LEAD UPTAKES:

Year	Air (ug/day)	Diet (ug/day)	Alternate (ug/day)	Water (ug/day)
.5-1	0.021	2.538	0.000	1.579
1-2	0.034	2.605	0.000	3.876
2-3	0.062	2.958	0.000	4.076
3-4	0.067	2.881	0.000	4.208
4-5	0.067	2.823	0.000	4.444
5-6	0.093	2.999	0.000	4.718
6-7	0.093	3.323	0.000	4.817

Year	Soil +Dust (ug/day)	Total (ug/day)	Blood (ug/dL)
.5-1	3.379	7.516	4.1
1-2	5.270	11.785	4.8
2-3	5.329	12.425	4.6
3-4	5.398	12.554	4.4
4-5	4.069	11.403	3.9
5-6	3.687	11.497	3.6
6-7	3.495	11.728	3.3

Appendix F

SEAD-71 (Fenced Area Excluded) Human Health Risk Assessment Calculation Tables

- F-1 Occurrence, Distribution, and Selection of Chemicals of Potential Concern
- F-2 Surface Soil – Soil Exposure Point Concentration Summary
- F-3 Surface and Subsurface Soil – Soil Exposure Point Concentration Summary
- F-4 Surface Soil – Ambient Air Exposure Point Concentrations
- F-5 Surface and Subsurface Soil – Ambient Air Exposure Point Concentrations
- F-6 Calculation of Intake and Risk from the Ingestion of Soil – RME
- F-7 Calculation of Intake and Risk from the Ingestion of Soil – CT
- F-8 Calculation of Absorbed Dose and Risk from Dermal Contact to Soil – RME
- F-9 Calculation of Absorbed Dose and Risk from Dermal Contact to Soil – CT
- F-10 Calculation of intake and Risk from Inhalation of Dust in Ambient Air – RME
- F-11 Calculation of intake and Risk from Inhalation of Dust in Ambient Air – CT
- F-12 Calculation of Blood Lead Concentration – Industrial Worker
- F-13 Calculation of Blood Lead Concentration – Construction Worker

**TABLE F-1
OCCURRENCE, DISTRIBUTION AND SELECTION OF CHEMICALS OF POTENTIAL CONCERN IN SEAD-71 SOIL (FENCED AREA EXCLUDED)
SEAD-59 AND SEAD-71 PHASE II RI
Seneca Army Depot Activity**

Scenario Timeframe:	Current/Future
Medium:	Soil
Exposure Medium:	Soil
Exposure Point:	SEAD-71

CAS Number	Chemical	Minimum Detected Concentration ¹ (mg/kg)	Q	Maximum Detected Concentration ¹ (mg/kg)	Q	Location of Maximum Concentration	Detection Frequency ¹	Range of Reporting Limits ¹ (mg/kg)		Concentration Used for Screening ² (mg/kg)	Background Value ³ (mg/kg)	Screening Value ⁴ (mg/kg)	Potential ARAR/TBC Value ⁵ (mg/kg)	COPC Flag	Rationale for Contaminant Deletion or Selection ⁶
VOC															
71-55-6	1,1,1-Trichloroethane	0.002	NJ	0.023		TP71-1	6 / 61	0.005	- 0.11	0.023		1,200	0.8	NO	BSL
67-64-1	Acetone	0.004	NJ	0.074		SS71-14	9 / 61	0.005	- 0.11	0.074		14,000	0.2	NO	BSL
71-43-2	Benzene	0.001	J	0.002	J	SS71-1	2 / 61	0.005	- 0.11	0.002		0.64	0.06	NO	BSL
75-15-0	Carbon disulfide	0.002	J	0.005	J	CL-71-B-WN1	3 / 61	0.005	- 0.11	0.005		360	2.7	NO	BSL
110-82-7	Cyclohexane	0.003	J	0.004	J	WS-71-A-009-9	2 / 23	0.005	- 0.006	0.004		140		NO	BSL
108-87-2	Methyl cyclohexane	0.003	J	0.006		WS-71-A-009-9	3 / 23	0.005	- 0.006	0.006		2,600		NO	BSL
75-09-2	Methylene chloride	0.001	J	0.002	J	SS71-1	8 / 61	0.005	- 0.11	0.002		9.1	0.1	NO	BSL
127-18-4	Tetrachloroethene	0.001	J	0.003	J	TP71-1	3 / 61	0.005	- 0.11	0.003		0.48	1.4	NO	BSL
108-88-3	Toluene	0.001	J	0.004	J	SS71-1	4 / 61	0.005	- 0.11	0.004		520	1.5	NO	BSL
	Total BTEX	3.05		11.6		TP71-3-1	4 / 4			11.6				NO	ICE
1330-20-7	Total Xylenes	0.002	J	0.096	J	TP71-3-2	4 / 37	0.005	- 0.015	0.096		270	1.2	NO	BSL
75-69-4	Trichlorofluoromethane	0.001	J	0.001	J	WS-71-B-009-6	1 / 23	0.005	- 0.006	0.001		390		NO	BSL
SVOC															
121-14-2	2,4-Dinitrotoluene	0.88	J	0.88	J	WS-71-D-009-13	1 / 62	0.066	- 19	0.88		120		NO	BSL
91-57-6	2-Methylnaphthalene	0.0086	J	31	J	TP71-3-2	12 / 62	0.078	- 19	31		310	36.4	NO	BSL
100-01-6	4-Nitroaniline	0.075	J	0.075	J	WS-71-B-009-6	1 / 40	0.16	- 45	0.075		23		NO	BSL
83-32-9	Acenaphthene	0.0055	J	13	J	TP71-3-2	23 / 62	0.078	- 5.5	13		3,700	50	NO	BSL
208-96-8	Acenaphthylene	0.02	J	1.8		CL-71-C-WN1	20 / 62	0.066	- 19	1.8			41	NO	NSV
120-12-7	Anthracene	0.012	J	11	J	TP71-1	35 / 62	0.078	- 5.5	11		22,000	50	NO	BSL
56-55-3	Benzo(a)anthracene	0.0039	J	37		TP71-1	46 / 62	0.078	- 1.9	37		0.62	0.224	YES	ASL
50-32-8	Benzo(a)pyrene	0.0039	J	22		TP71-1	46 / 62	0.066	- 1.9	22		0.062	0.061	YES	ASL
205-99-2	Benzo(b)fluoranthene	0.0044	J	26		TP71-1	47 / 62	0.066	- 1.9	26		0.62	1.1	YES	ASL
191-24-2	Benzo(ghi)perylene	0.012	J	10	J	TP71-1	40 / 62	0.066	- 1.9	10			50	NO	NSV
207-08-9	Benzo(k)fluoranthene	0.0046	J	15	J	TP71-1	36 / 62	0.066	- 1.9	15		6.2	1.1	YES	ASL
117-81-7	Bis(2-Ethylhexyl)phthalate	0.0076	J	0.14	J	WS-71-D-009-13	9 / 62	0.066	- 19	0.14		35	50	NO	BSL
86-74-8	Carbazole	0.0042	J	9.5	J	TP71-1	22 / 40	0.078	- 1.1	9.5		24		NO	BSL
218-01-9	Chrysene	0.0046	J	36		TP71-1	49 / 62	0.078	- 1.9	36		62	0.4	NO	BSL
84-74-2	Di-n-butylphthalate	0.0064	J	0.07	J	CL-71-C-WE2	3 / 62	0.066	- 19	0.07		6,100	8.1	NO	BSL
53-70-3	Dibenz(a,h)anthracene	0.0044	J	9.8	J	TP71-1	32 / 62	0.066	- 5.5	9.8		0.062	0.014	YES	ASL
132-64-9	Dibenzofuran	0.013	J	11	J	TP71-3-2	18 / 62	0.078	- 19	11		150	6.2	NO	BSL
206-44-0	Fluoranthene	0.0069	J	88		TP71-1	50 / 62	0.078	- 0.4	88		2,300	50	NO	BSL
86-73-7	Fluorene	0.0047	J	4.1		TP71-3-2	21 / 62	0.078	- 5.5	4.1		2,700	50	NO	BSL
193-39-5	Indeno(1,2,3-cd)pyrene	0.012	J	12	J	TP71-1	40 / 62	0.066	- 1.9	12		0.62	3.2	YES	ASL

**TABLE F-1
OCCURRENCE, DISTRIBUTION AND SELECTION OF CHEMICALS OF POTENTIAL CONCERN IN SEAD-71 SOIL (FENCED AREA EXCLUDED)
SEAD-59 AND SEAD-71 PHASE II RI
Seneca Army Depot Activity**

Scenario Timeframe:	Current/Future
Medium:	Soil
Exposure Medium:	Soil
Exposure Point:	SEAD-71

CAS Number	Chemical	Minimum Detected Concentration ¹ (mg/kg)	Q	Maximum Detected Concentration ¹ (mg/kg)	Q	Location of Maximum Concentration	Detection Frequency ¹	Range of Reporting Limits ¹ (mg/kg)	Concentration Used for Screening ² (mg/kg)	Background Value ³ (mg/kg)	Screening Value ⁴ (mg/kg)	Potential ARAR/TBC Value ⁵ (mg/kg)	COPC Flag	Rationale for Contaminant Deletion or Selection ⁶	
91-20-3	Naphthalene	0.01	J	17	J	TP71-3-2	13 / 62	0.078 - 19	17		56	13	NO	BSL	
85-01-8	Phenanthrene	0.024	J	66		TP71-1	45 / 62	0.078 - 1.9	66			50	NO	NSV	
108-95-2	Phenol	0.0045	J	0.0045	J	TP71-3-1	1 / 62	0.078 - 19	0.0045		18,000	0.03	NO	BSL	
129-00-0	Pyrene	0.006	J	63		TP71-1	48 / 62	0.078 - 1.9	63		2,300	50	NO	BSL	
Pesticide															
72-54-8	4,4'-DDD	0.0028	J	0.017		CL-71-B-WE2	9 / 62	0.0035 - 0.04	0.017		2.4	2.9	NO	BSL	
72-55-9	4,4'-DDE	0.0031	J	0.19		CL-71-B-WS1	22 / 62	0.0034 - 0.038	0.19		1.7	2.1	NO	BSL	
50-29-3	4,4'-DDT	0.0051	J	0.12		CL-71-E2-WW1	28 / 62	0.0034 - 0.038	0.12		1.7	2.1	NO	BSL	
319-84-6	Alpha-BHC	0.0019	J	0.018		TP71-6-1	5 / 62	0.0018 - 0.021	0.018		0.09	0.11	NO	BSL	
5103-71-9	Alpha-Chlordane	0.074	J	0.074	J	TP71-1	1 / 62	0.0018 - 0.021	0.074		1.6		NO	BSL	
319-85-7	Beta-BHC	0.002	J	0.0027		TP71-6-1	2 / 62	0.0018 - 0.021	0.0027		0.32	0.2	NO	BSL	
319-86-8	Delta-BHC	0.0018	J	0.0018	J	TP71-6-1	1 / 62	0.0018 - 0.021	0.0018		0.09	0.3	NO	BSL	
60-57-1	Dieldrin	0.003	J	0.0035	J	TP71-1	3 / 62	0.0034 - 0.04	0.0035		0.03	0.044	NO	BSL	
959-98-8	Endosulfan I	0.0028	J	0.2	J	TP71-1	4 / 62	0.0018 - 0.021	0.2		370	0.9	NO	BSL	
33213-65-9	Endosulfan II	0.0025	J	0.026	J	TP71-1	2 / 62	0.0034 - 0.04	0.026		370	0.9	NO	BSL	
1031-07-8	Endosulfan sulfate	0.0027	J	0.0046		SS71-8	4 / 62	0.0034 - 0.04	0.0046		370	1	NO	BSL	
72-20-8	Endrin	0.0024	J	0.029	J	TP71-1	5 / 62	0.0034 - 0.04	0.029		18	0.1	NO	BSL	
7421-93-4	Endrin aldehyde	0.003	J	0.0091		SS71-10	9 / 62	0.0034 - 0.04	0.0091		18		NO	BSL	
53494-70-5	Endrin ketone	0.0022	J	0.017		SS71-10	7 / 62	0.0034 - 0.04	0.017		18		NO	BSL	
58-89-9	Gamma-BHC/Lindane	0.004		0.004		TP71-6-1	1 / 62	0.0018 - 0.021	0.004		0.44	0.06	NO	BSL	
5103-74-2	Gamma-Chlordane	0.0011	J	0.0012	J	SS71-1	2 / 62	0.0018 - 0.021	0.0012		1.6	0.54	NO	BSL	
76-44-8	Heptachlor	0.0012	J	0.0012	J	TP71-1	1 / 62	0.0018 - 0.021	0.0012		0.11	0.1	NO	BSL	
1024-57-3	Heptachlor epoxide	0.0015	J	0.0064		SS71-2	5 / 62	0.0018 - 0.021	0.0064		0.053	0.02	NO	BSL	
72-43-5	Methoxychlor	0.019	J	0.062		SS71-8	3 / 62	0.018 - 0.21	0.062		310		NO	BSL	
PCB															
11096-82-5	Aroclor-1260	0.08		0.2	J	CL-71-B-WE2	3 / 62	0.035 - 0.37	0.2		0.22	10	NO	BSL	
Metals															
7429-90-5	Aluminum	6,120	J	15,900		SS71-9	62 / 62		15,900	14,315	76,000	19,300	NO	BSL	
7440-36-0	Antimony	0.19	J	11.5	J	CL-71-B-WE2	29 / 62	0.23 - 3.6	11.5	3.3	31	5.9	NO	BSL	
7440-38-2	Arsenic	3.1		14.6		SS71-9	62 / 62		14.6	6.0	0.39	8.2	YES	ASL	
7440-39-3	Barium	47	J	136	J	CL-71-E1-WN1	62 / 62		136	86	5,400	300	NO	BSL	
7440-41-7	Beryllium	0.11		0.85		CL-71-E1-WN1	62 / 62		0.85	0.73	150	1.1	NO	BSL	
7440-43-9	Cadmium	0.17	J	0.71		CL-71-E3-WS1	40 / 62	0.07 - 0.3	0.71	0.74	37	2.3	NO	BSL	
7440-70-2	Calcium	6,040	J	295,000		SS71-14	62 / 62		295,000	60,396	2,500,000	121,000	NO	NUT	

TABLE F-1
OCCURRENCE, DISTRIBUTION AND SELECTION OF CHEMICALS OF POTENTIAL CONCERN IN SEAD-71 SOIL (FENCED AREA EXCLUDED)
SEAD-59 AND SEAD-71 PHASE II RI
Seneca Army Depot Activity

Scenario Timeframe:	Current/Future
Medium:	Soil
Exposure Medium:	Soil
Exposure Point:	SEAD-71

CAS Number	Chemical	Minimum Detected Concentration ¹ (mg/kg)	Q	Maximum Detected Concentration ¹ (mg/kg)	Q	Location of Maximum Concentration	Detection Frequency ¹	Range of Reporting Limits ¹ (mg/kg)	Concentration Used for Screening ² (mg/kg)	Background Value ³ (mg/kg)	Screening Value ⁴ (mg/kg)	Potential ARAR/TBC Value ⁵ (mg/kg)	COPC Flag	Rationale for Contaminant Deletion or Selection ⁶
7440-47-3	Chromium	10	J	37.1		CL-71-C-WN1	62 / 62		37.1	22	210	29.6	NO	BSL
7440-48-4	Cobalt	6.1	J	13.9		CL-71-E3-WS1	62 / 62		13.9	13	900	30	NO	BSL
7440-50-8	Copper	15.2		102		WS-71-E1-009-3	62 / 62		102	23	3,100	33	NO	BSL
7439-89-6	Iron	13,200		38,000		SS71-9	62 / 62		38,000	26,489	23,000	36,500	YES	ASL
7439-92-1	Lead	7.3		1,010		WS-71-D-009-13	62 / 62		1,010	28	400	24.8	YES	ASL
7439-95-4	Magnesium	3,800		59,300		SS71-14	62 / 62		59,300	12,170	400,000	21,500	NO	NUT
7439-96-5	Manganese	296		1,330		CL-71-E3-WS1	62 / 62		1,330	701	1,800	1,060	NO	BSL
7439-97-6	Mercury	0.02	J	1	J	CL-71-B-WS1	52 / 62	0.05 - 0.07	1	0.046	23	0.1	NO	BSL
7440-02-0	Nickel	18	J	110		SS71-10	62 / 62		110	34	1,600	49	NO	BSL
7440-09-7	Potassium	810	J	2,940		TP71-4-2	62 / 62		2,940	1,628	5,000,000	2,380	NO	NUT
7782-49-2	Selenium	0.43	J	1.8	J	SS71-10	8 / 62	0.37 - 1.1	1.8	0.45	390	2	NO	BSL
7440-22-4	Silver	0.32	J	1.8		CL-71-E1-WN1	22 / 62	0.07 - 0.67	1.8	0.45	390	0.75	NO	BSL
7440-23-5	Sodium	33.2	J	636		SS71-10	59 / 62	83.3 - 108	636	103	1,125,000	172	NO	NUT
7440-28-0	Thallium	0.57	J	2.3		SS71-9	18 / 62	0.19 - 1.7	2.3	0.32	5.2	0.7	NO	BSL
7440-62-2	Vanadium	11.3	J	24.9		TP71-4-2	62 / 62		24.9	23	78	150	NO	BSL
7440-66-6	Zinc	45.3		1,740	J	SS71-10	61 / 62	352 - 352	1,740	77	23,000	110	NO	BSL

Notes:

- Field duplicates were averaged and regarded as one sample entry. Lab duplicates were not included in the assessment. Range of reporting limits were presented for nondetects only.
- The maximum detected concentration was used for screening.
- Background value is the 95% upper confidence limit of the arithmetic mean of the Seneca background concentrations.
- EPA Region 9 Preliminary Remediation Goals (PRGs) for residential soil. On-line resources available at <http://www.epa.gov/region09/waste/sfund/prg/files/prgtable2004.xls>. Last updated October 2004. Target Cancer Risk = 1E-6; Target Hazard Quotient = 1. Direct contact exposure (ingestion and dermal contact) is evaluated to derive the PRGs. EPA Region III Risk Based Concentration (RBC) for residential soil was used as screening value for 2-methylnaphthalene as no Region 9 PRG is available. EPA Region III RBC, available on-line at <http://www.epa.gov/reg3hwmd/risk/human/rbc/rbc1004.XLS>, was calculated based on soil ingestion exposure and a target cancer risk of 1E-6 and a target hazard quotient of 1. PRG for Aroclor 1254 was used as screening value for Aroclor 1260. PRG for gamma-chlordane was used as screening value for alpha-chlordane. PRG for alpha-BHC was used as screening value for delta-BHC. PRG for endosulfan was used as screening value for endosulfan I, endosulfan II, and endosulfan sulfate. PRG for endrin was used as screening value for endrin aldehyde and endrin ketone. Screening values for calcium, magnesium, potassium, and sodium were calculated based on an assumption of 200 mg/day soil ingestion and recommended dietary allowances and adequate intakes for 1-3 yr children (500 mg/day and 80 mg/day for calcium and magnesium) and

TABLE F-1
OCCURRENCE, DISTRIBUTION AND SELECTION OF CHEMICALS OF POTENTIAL CONCERN IN SEAD-71 SOIL (FENCED AREA EXCLUDED)
SEAD-59 AND SEAD-71 PHASE II RI
Seneca Army Depot Activity

Scenario Timeframe:	Current/Future
Medium:	Soil
Exposure Medium:	Soil
Exposure Point:	SEAD-71

CAS Number	Chemical	Minimum Detected Concentration ¹ (mg/kg)	Q	Maximum Detected Concentration ¹ (mg/kg)	Q	Location of Maximum Concentration	Detection Frequency ¹	Range of Reporting Limits ¹ (mg/kg)	Concentration Used for Screening ² (mg/kg)	Background Value ³ (mg/kg)	Screening Value ⁴ (mg/kg)	Potential ARAR/TBC Value ⁵ (mg/kg)	COPC Flag	Rationale for Contaminant Deletion or Selection ⁶
------------	----------	--	---	--	---	-----------------------------------	----------------------------------	---	--	--	---	--	-----------	--

minimum requirements for 1 yr children (225 mg/day and 1000 mg/day for sodium and potassium)

from Marilyn Wright (2001) Dietary Reference Intakes.

PRG for total chromium (1:6 ratio Cr VI: Cr III) was used as screening value for chromium.

PRG for nickel (soluble salts) was used as screening value for nickel.

5. Potential ARAR/TBC values are from NYSDEC Technical and Administrative Guidance Memorandum #4046
(on-line resources available at <http://www.dec.state.ny.us/website/der/tagms/prtg4046.html>)

6. Rationale codes
Selection Reason: Above Screening Levels (ASL)
Deletion Reason: Essential Nutrient (NUT)
Below Screening Level (BSL)
Individual Chemicals Evaluated (ICE)
No Screening Value or Toxicity Value (NSV)

Definitions:
COPC = Chemical of Potential Concern
ARAR/TBC = Applicable or Relevant and Appropriate Requirement/To Be Considered
Q = Qualifier
J = Estimated Value
NJ = Presence of the analyte has been "tentatively identified" and the associated numerical value represents its approximate concentration.

TABLE F-2
SOIL EXPOSURE POINT CONCENTRATION SUMMARY - SURFACE SOIL FOR SEAD-71 (FENCED AREA EXCLUDED)
SEAD-59 AND SEAD-71 PHASE II RI
SENECA ARMY DEPOT ACTIVITY

Scenario Timeframe:	Current/Future
Medium:	Soil
Exposure Medium:	Soil
Exposure Point:	SEAD-71

Chemical of Potential Concern	Units	Arithmetic Mean (1)	95% UCL of Normal Data (1)	Maximum Detected Concentration (1)	Q	EPC Units	Reasonable Maximum Exposure (2)			Central Tendency (2)		
							Medium EPC Value	Medium EPC Statistic	Medium EPC Rationale	Medium EPC Value	Medium EPC Statistic	Medium EPC Rationale
Surface Soil												
Benzo(a)anthracene	mg/kg	1.0	1.5	10		mg/kg	2.9	97.5% Chebyshev	Non-parametric, MH	2.9	97.5% Chebyshev	Non-parametric, MH
Benzo(a)pyrene	mg/kg	1.0	1.5	9		mg/kg	2.7	97.5% Chebyshev	Non-parametric, MH	2.7	97.5% Chebyshev	Non-parametric, MH
Benzo(b)fluoranthene	mg/kg	0.9	1.4	7.4		mg/kg	1.6	95% H-UCL	Lognormal, MH	1.6	95% H-UCL	Lognormal, MH
Benzo(k)fluoranthene	mg/kg	0.9	1.3	8		mg/kg	2.4	97.5% Chebyshev	Non-parametric, MH	2.4	97.5% Chebyshev	Non-parametric, MH
Chrysene	mg/kg	1.2	1.7	10		mg/kg	1.9	95% H-UCL	Lognormal, MH	1.9	95% H-UCL	Lognormal, MH
Dibenz(a,h)anthracene	mg/kg	0.35	0.47	2	J	mg/kg	0.7	95% Chebyshev	Non-parametric, MO	0.7	95% Chebyshev	Non-parametric, MO
Indeno(1,2,3-cd)pyrene	mg/kg	0.65	0.93	5.4	J	mg/kg	1.7	97.5% Chebyshev	Non-parametric, MH	1.7	97.5% Chebyshev	Non-parametric, MH
Arsenic	mg/kg	5.9	6.3	14.6		mg/kg	6.3	95% Approximate Gamma	Gamma	6.3	95% Approximate Gamma	Gamma
Iron	mg/kg	23,129	24,133	38,000		mg/kg	24,133	95% Student t	Normal	24,133	95% Student t	Normal
Lead	mg/kg	115	N/A	1,010		mg/kg	115	Mean	Mean	115	Mean	Mean

Notes:

- Field duplicates were averaged and regarded as one sample entry. Lab duplicates were not included in the assessment. Nondetectes were assumed to be half reporting limits.
- The EPCs were calculated using the ProUCL (Version 3.00.02) and the EPCs were selected in accordance with the ProUCL Version 3.0 User Guide (USEPA, 2004) and the Calculating Upper Confidence Limits for Exposure Point Concentrations at Hazardous Waste Sites (USEPA, 2002). The average lead concentration was used as the lead EPC in accordance with the User's Guide for the Integrated Exposure Uptake Biokinetic Model for Lead in Children (IEUBK) Windows® Version – 32 bit Version (USEPA, 2002).
 - HE - highly skewed to extremely highly skewed (standard deviation of log-transformed data in the interval (2.0, 3.0] data set.
 - MH - moderately to highly skewed (standard deviation of log-transformed data in the interval (1.0, 2.0] data set.
 - MO - moderately skewed (standard deviation of log-transformed data in the interval (0.5, 1.0] data set
 - M - mildly skewed (standard deviation of log-transformed data less than or equal to 0.5) data set.
 - Q - qualifier
 - J = Estimated Value

TABLE F-3
 SOIL EXPOSURE POINT CONCENTRATION SUMMARY - SURFACE AND SUBSURFACE SOIL FOR SEAD-71 (FENCED AREA EXCLUDED)
 SEAD-59 AND SEAD-71 PHASE II RI
 SENECA ARMY DEPOT ACTIVITY

Scenario Timeframe:	Current/Future
Medium:	Soil
Exposure Medium:	Soil
Exposure Point:	SEAD-71

Chemical of Potential Concern	Units	Arithmetic Mean (1)	95% UCL of Normal Data (1)	Maximum Detected Concentration (1)	Q	EPC Units	Reasonable Maximum Exposure (2)			Central Tendency (2)		
							Medium EPC Value	Medium EPC Statistic	Medium EPC Rationale	Medium EPC Value	Medium EPC Statistic	Medium EPC Rationale
Surface and Subsurface Soil												
Benzo(a)anthracene	mg/kg	1.6	2.6	37		mg/kg	5.5	97.5% Chebyshev	Non-parametric, MH	5.5	97.5% Chebyshev	Non-parametric, MH
Benzo(a)pyrene	mg/kg	1.3	1.9	22		mg/kg	3.8	97.5% Chebyshev	Non-parametric, MH	3.8	97.5% Chebyshev	Non-parametric, MH
Benzo(b)fluoranthene	mg/kg	1.3	2.1	26		mg/kg	2.2	95% H-UCL	Lognormal, MH	2.2	95% H-UCL	Lognormal, MH
Benzo(k)fluoranthene	mg/kg	1	1.5	15	J	mg/kg	3	97.5% Chebyshev	Non-parametric, MH	3	97.5% Chebyshev	Non-parametric, MH
Chrysene	mg/kg	1.6	2.7	36		mg/kg	2.6	95% H-UCL	Lognormal, MH	2.6	95% H-UCL	Lognormal, MH
Dibenz(a,h)anthracene	mg/kg	0.5	0.8	9.8	J	mg/kg	1.5	97.5% Chebyshev	Non-parametric, MH	1.5	97.5% Chebyshev	Non-parametric, MH
Indeno(1,2,3-cd)pyrene	mg/kg	0.8	1.2	12	J	mg/kg	2.2	97.5% Chebyshev	Non-parametric, MH	2.2	97.5% Chebyshev	Non-parametric, MH
Arsenic	mg/kg	5.8	6.1	14.6		mg/kg	6.1	95% H-UCL	Lognormal	6.1	95% H-UCL	Lognormal
Iron	mg/kg	22,859	23,752	38,000		mg/kg	23,752	95% Student t UCL	Normal	23,752	95% Student t UCL	Normal
Lead	mg/kg	104.5	N/A	1,010		mg/kg	104.5	Mean	Mean	104.5	Mean	Mean

Notes:

- Field duplicates were averaged and regarded as one sample entry. Lab duplicates were not included in the assessment.
 Nondetectes were assumed to be half reporting limits.
- The EPCs were calculated using the ProUCL (Version 3.00.02) and the EPCs were selected in accordance with the ProUCL Version 3.0 User Guide (USEPA, 2004) and the Calculating Upper Confidence Limits for Exposure Point Concentrations at Hazardous Waste Sites (USEPA, 2002). The average lead concentration was used as the lead EPC in accordance with the User's Guide for the Integrated Exposure Uptake Biokinetic Model for Lead in Children (IEUBK) Windows® Version – 32 bit Version (USEPA, 2002).
 HE - highly skewed to extremely highly skewed (standard deviation of log-transformed data in the interval (2.0, 3.0] data set.
 MH - moderately to highly skewed (standard deviation of log-transformed data in the interval (1.0, 2.0] data set.
 MO - moderately skewed (standard deviation of log-transformed data in the interval (0.5, 1.0] data set
 M - mildly skewed (standard deviation of log-transformed data less than or equal to 0.5) data set.
 Q - qualifier
 J = Estimated Value

TABLE F-4
 AMBIENT AIR EXPOSURE POINT CONCENTRATIONS - SURFACE SOIL FOR SEAD-71 (FENCED AREA EXCLUDED
 SEAD-59 AND SEAD-71 PHASE II RI
 Seneca Army Depot Activity

Scenario Timeframe:	Current/Future
Medium:	Soil
Exposure Medium:	Air
Exposure Point:	SEAD-71

Equation for Air EPC from Surface Soil (mg/m³) = CSsurf x PM10 x CF

Variables:
 CSsurf = Chemical Concentration in Surface Soil, from EPC data (mg/kg)
 PM10 = Average Measured PM10 Concentration = 17 ug/m³
 CF = Conversion Factor = 1E-9 kg/ug

Analyte	Reasonable Maximum Exposure		Central Tendency Exposure	
	EPC Data for Surface Soil	Calculated Air EPC Surface Soil	EPC Data for Surface Soil	Calculated Air EPC Surface Soil
	(mg/kg)	(mg/m ³)	(mg/kg)	(mg/m ³)
Benzo(a)anthracene	2.9	4.9E-08	2.9	4.9E-08
Benzo(a)pyrene	2.7	4.6E-08	2.7	4.6E-08
Benzo(b)fluoranthene	1.6	2.7E-08	1.6	2.7E-08
Benzo(k)fluoranthene	2.4	4.1E-08	2.4	4.1E-08
Chrysene	1.9	3.2E-08	1.9	3.2E-08
Dibenz(a,h)anthracene	0.7	1.2E-08	0.7	1.2E-08
Indeno(1,2,3-cd)pyrene	1.7	2.9E-08	1.7	2.9E-08
Arsenic	6.3	1.1E-07	6.3	1.1E-07
Iron	24133	4.1E-04	24133	4.1E-04
Lead	115	2.0E-06	115	2.0E-06

TABLE F-5
AMBIENT AIR EXPOSURE POINT CONCENTRATIONS - SURFACE AND SUBSURFACE SOIL FOR SEAD-71 (FENCED AREA EXCLUDED)
SEAD-59 AND SEAD-71 PHASE II RI
Seneca Army Depot Activity

Scenario Timeframe:	Current/Future
Medium:	Soil
Exposure Medium:	Air
Exposure Point:	SEAD-71

Equation for Air EPC from Total Soils (mg/m³) = CStot x PM10 x CF

Variables:
 CStot = Chemical Concentration in Total Soils, from EPC data (mg/kg)
 PM10 = PM10 Concentration Calculated for Construction Worker= 954 ug/m³
 CF = Conversion Factor = 1E-9 kg/ug

Analyte	Reasonable Maximum Exposure		Central Tendency Exposure	
	EPC Data for Surface and Subsurface Soil (mg/kg)	Calculated Air EPC Surface and Subsurface Soil (mg/m ³)	EPC Data for Surface and Subsurface Soil (mg/kg)	Calculated Air EPC Surface and Subsurface Soil (mg/m ³)
Benzo(a)anthracene	5.5	5.2E-06	5.5	5.2E-06
Benzo(a)pyrene	3.8	3.6E-06	3.8	3.6E-06
Benzo(b)fluoranthene	2.2	2.1E-06	2.2	2.1E-06
Benzo(k)fluoranthene	3	2.9E-06	3	2.9E-06
Chrysene	2.6	2.5E-06	2.6	2.5E-06
Dibenz(a,h)anthracene	1.5	1.4E-06	1.5	1.4E-06
Indeno(1,2,3-cd)pyrene	2.2	2.1E-06	2.2	2.1E-06
Arsenic	6.1	5.8E-06	6.1	5.8E-06
Iron	23752	2.3E-02	23752	2.3E-02
Lead	104.5	1.0E-04	104.5	1.0E-04

**TABLE F-6
CALCULATION OF INTAKE AND RISK FROM THE INGESTION OF SOIL
REASONABLE MAXIMUM EXPOSURE (RME) - SEAD-71 (FENCED AREA EXCLUDED)
SEAD-59 AND SEAD-71 PHASE II RI
Seneca Army Depot Activity**

Equation for Intake (mg/kg-day) =	$\frac{EPC \times IR \times CF \times FI \times EF \times ED \times B}{BW \times AT}$	Equation for Hazard Quotient = Chronic Daily Intake (Nc)/Reference Dose
Variables (Assumptions for Each Receptor are Listed at the Bottom):		Equation for Cancer Risk = Chronic Daily Intake (Car) x Slope Factor
EPC = Exposure Point Concentration in Soil, mg/kg	EF = Exposure Frequency	
IR = Ingestion Rate	ED = Exposure Duration	
CF = Conversion Factor	BW = Bodyweight	
FI = Fraction Ingested	AT = Averaging Time	
	B = Bioavailability	

Analyte	Oral RfD (mg/kg-day)	Carc. Slope Oral (mg/kg-day) ⁻¹	Bioavailability (unitless)	EPC Surface Soil (mg/kg)	EPC from Total Soils (mg/kg)	Industrial Worker			Construction Worker			Child Trespasser					
						Intake (mg/kg-day)		Hazard Quotient	Cancer Risk	Intake (mg/kg-day)		Hazard Quotient	Cancer Risk	Intake (mg/kg-day)		Hazard Quotient	Cancer Risk
						(Nc)	(Car)			(Nc)	(Car)			(Nc)	(Car)		
Benzo(a)anthracene	N/A	7.3E-01	0.29	2.9E+00	5.5E+00		2.94E-07		2E-07		7.36E-08		5E-08		3.69E-08		3E-08
Benzo(a)pyrene	N/A	7.3E+00	0.29	2.7E+00	3.8E+00		2.74E-07		2E-06		5.08E-08		4E-07		3.43E-08		3E-07
Benzo(b)fluoranthene	N/A	7.3E-01	0.29	1.6E+00	2.2E+00		1.62E-07		1E-07		2.94E-08		2E-08		2.03E-08		1E-08
Benzo(k)fluoranthene	N/A	7.3E-02	0.29	2.4E+00	3.0E+00		2.43E-07		2E-08		4.01E-08		3E-09		3.05E-08		2E-09
Chrysene	N/A	7.3E-03	0.29	1.9E+00	2.6E+00		1.93E-07		1E-09		3.48E-08		3E-10		2.42E-08		2E-10
Dibenz(a,h)anthracene	N/A	7.3E+00	0.29	7.0E-01	1.5E+00		7.09E-08		5E-07		2.01E-08		1E-07		8.90E-09		6E-08
Indeno(1,2,3-cd)pyrene	N/A	7.3E-01	0.29	1.7E+00	2.2E+00		1.72E-07		1E-07		2.94E-08		2E-08		2.16E-08		2E-08
Arsenic	3.00E-04	1.5E+00	1	6.3E+00	6.1E+00	6.16E-06	2.20E-06	2E-02	3E-06	1.97E-05	2.81E-07	7E-02	4E-07	3.22E-06	2.76E-07	1E-02	4E-07
Iron	3.00E-01	N/A	1	2.4E+04	2.4E+04	2.36E-02		8E-02		7.67E-02		3E-01		1.23E-02		4E-02	
Total Hazard Quotient and Cancer Risk:								1E-01	6E-06			3E-01	1E-06			5E-02	8E-07
						Assumptions for Industrial Worker			Assumptions for Construction Worker			Assumptions for Child Trespasser					
						CF =	1E-06 kg/mg	CF =	1E-06 kg/mg	CF =	1E-06 kg/mg	EPC =	EPC Surface Only	EPC =	EPC Surface Only		
						EPC =	EPC Surface Only	EPC =	EPC Surface and Subsurface	EPC =	EPC Surface Only	BW =	15 kg	BW =	70 kg		
						BW =	70 kg	BW =	70 kg	BW =	70 kg	IR =	200 mg/day	IR =	330 mg/day		
						IR =	100 mg/day	IR =	330 mg/day	IR =	330 mg/day	FI =	1 unitless	FI =	1 unitless		
						FI =	1 unitless	FI =	1 unitless	FI =	1 unitless	EF =	14 days/year	EF =	250 days/year		
						EF =	250 days/year	EF =	250 days/year	EF =	250 days/year	ED =	6 years	ED =	25 years		
						ED =	25 years	ED =	1 years	ED =	1 years	AT (Nc) =	2,190 days	AT (Nc) =	9,125 days		
						AT (Nc) =	9,125 days	AT (Nc) =	365 days	AT (Nc) =	365 days	AT (Car) =	25,550 days	AT (Car) =	25,550 days		
						AT (Car) =	25,550 days	AT (Car) =	25,550 days	AT (Car) =	25,550 days						

Note: Cells in this table were intentionally left blank due to a lack of toxicity data.
NA= Information not available.

**TABLE F-7
CALCULATION OF INTAKE AND RISK FROM THE INGESTION OF SOIL
CENTRAL TENDENCY (CT) - SEAD-71 (FENCED AREA EXCLUDED)
SEAD-59 AND SEAD-71 PHASE II RI
Seneca Army Depot Activity**

Equation for Intake (mg/kg-day) =	$\frac{EPC \times IR \times CF \times FI \times EF \times ED \times B}{BW \times AT}$	Equation for Hazard Quotient = Chronic Daily Intake (Nc)/Reference Dose
<u>Variables (Assumptions for Each Receptor are Listed at the Bottom):</u>		Equation for Cancer Risk = Chronic Daily Intake (Car) x Slope Factor
EPC = Exposure Point Concentration in Soil, mg/kg		
IR = Ingestion Rate		EF = Exposure Frequency
CF = Conversion Factor	B = Bioavailability	ED = Exposure Duration
FI = Fraction Ingested		BW = Bodyweight
		AT = Averaging Time

Analyte	Oral RfD (mg/kg-day)	Carc. Slope Oral (mg/kg-day) ⁻¹	Bioavailability (unitless)	EPC Surface Soil (mg/kg)	EPC from Total Soils (mg/kg)	Industrial Worker			Construction Worker			Child Trespasser					
						Intake (mg/kg-day)		Hazard Quotient	Cancer Risk	Intake (mg/kg-day)		Hazard Quotient	Cancer Risk	Intake (mg/kg-day)		Hazard Quotient	Cancer Risk
						(Nc)	(Car)			(Nc)	(Car)			(Nc)	(Car)		
Benzo(a)anthracene	N/A	7.3E-01	0.29	2.9E+00	5.5E+00		4.63E-08		3E-08		1.95E-08		1E-08		1.84E-08		1E-08
Benzo(a)pyrene	N/A	7.3E+00	0.29	2.7E+00	3.8E+00		4.31E-08		3E-07		1.35E-08		1E-07		1.72E-08		1E-07
Benzo(b)fluoranthene	N/A	7.3E-01	0.29	1.6E+00	2.2E+00		2.56E-08		2E-08		7.81E-09		6E-09		1.02E-08		7E-09
Benzo(k)fluoranthene	N/A	7.3E-02	0.29	2.4E+00	3.0E+00		3.84E-08		3E-09		1.07E-08		8E-10		1.53E-08		1E-09
Chrysene	N/A	7.3E-03	0.29	1.9E+00	2.6E+00		3.04E-08		2E-10		9.23E-09		7E-11		1.21E-08		9E-11
Dibenz(a,h)anthracene	N/A	7.3E+00	0.29	7.0E-01	1.5E+00		1.12E-08		8E-08		5.33E-09		4E-08		4.45E-09		3E-08
Indeno(1,2,3-cd)pyrene	N/A	7.3E-01	0.29	1.7E+00	2.2E+00		2.72E-08		2E-08		7.81E-09		6E-09		1.08E-08		8E-09
Arsenic	3.00E-04	1.5E+00	1	6.3E+00	6.1E+00	2.70E-06	3.47E-07	9E-03	5E-07	5.23E-06	7.47E-08	2E-02	1E-07	1.61E-06	1.38E-07	5E-03	2E-07
Iron	3.00E-01	N/A	1	2.4E+04	2.4E+04	1.03E-02		3E-02		2.04E-02		7E-02		6.17E-03		2E-02	
Total Hazard Quotient and Cancer Risk:								4E-02	1E-06			9E-02	3E-07			3E-02	4E-07
						Assumptions for Industrial Worker			Assumptions for Construction Worker			Assumptions for Child Trespasser					
						CF =	1E-06 kg/mg				CF =	1E-06 kg/mg				CF =	1E-06 kg/mg
						EPC =	EPC Surface Only				EPC =	EPC Surface and Subsurface				EPC =	EPC Surface Only
						BW =	70 kg				BW =	70 kg				BW =	15 kg
						IR =	50 mg/day				IR =	100 mg/day				IR =	100 mg/day
						FI =	1 unitless				FI =	1 unitless				FI =	1 unitless
						EF =	219 days/year				EF =	219 days/year				EF =	14 days/year
						ED =	9 years				ED =	1 years				ED =	6 years
						AT (Nc) =	3,285 days				AT (Nc) =	365 days				AT (Nc) =	2,190 days
						AT (Car) =	25,550 days				AT (Car) =	25,550 days				AT (Car) =	25,550 days

Note: Cells in this table were intentionally left blank due to a lack of toxicity data.
NA= Information not available.

**TABLE F-8
CALCULATION OF ABSORBED DOSE AND RISK FROM DERMAL CONTACT TO SOIL
REASONABLE MAXIMUM EXPOSURE (RME) - SEAD-71 (FENCED AREA EXCLUDED)
SEAD-59 AND SEAD-71 PHASE II RI
Seneca Army Depot Activity**

Equation for Intake (mg/kg-day) =	$\frac{EPC \times CF \times SA \times AF \times ABS \times EV \times EF \times ED}{BW \times AT}$
Variables (Assumptions for Each Receptor are Listed at the Bottom):	
EPC = Chemical Concentration in Soil, mg/kg	EV = Event Frequency
CF = Conversion Factor	EF = Exposure Frequency
SA = Surface Area Contact	ED = Exposure Duration
AF = Adherence Factor	BW = Bodyweight
ABS = Absorption Factor	AT = Averaging Time

Equation for Hazard Quotient = Chronic Daily Intake (Nc)/Reference Dose

Equation for Cancer Risk = Chronic Daily Intake (Car) x Slope Factor

Analyte	Dermal RfD (mg/kg-day)	Carc. Slope Dermal (mg/kg-day)-1	Absorption Factor* (unitless)	EPC Surface Soil (mg/kg)	EPC from Total Soils (mg/kg)	Industrial Worker			Construction Worker			Child Trespasser					
						Absorbed Dose (mg/kg-day)		Hazard Quotient	Cancer Risk	Absorbed Dose (mg/kg-day)		Hazard Quotient	Cancer Risk	Absorbed Dose (mg/kg-day)		Hazard Quotient	Cancer Risk
						(Nc)	(Car)			(Nc)	(Car)			(Nc)	(Car)		
Benzo(a)anthracene	N/A	7.3E-01	1.3E-01	2.9E+00	5.5E+00		8.70E-07		6E-07		9.89E-08		7E-08		4.63E-08		3.38E-08
Benzo(a)pyrene	N/A	7.3E+00	1.3E-01	2.7E+00	3.8E+00		8.10E-07		6E-06		6.84E-08		5E-07		4.31E-08		3.14E-07
Benzo(b)fluoranthene	N/A	7.3E-01	1.3E-01	1.6E+00	2.2E+00		4.80E-07		4E-07		3.96E-08		3E-08		2.55E-08		1.86E-08
Benzo(k)fluoranthene	N/A	7.3E-02	1.3E-01	2.4E+00	3.0E+00		7.20E-07		5E-08		5.40E-08		4E-09		3.83E-08		2.80E-09
Chrysene	N/A	7.3E-03	1.3E-01	1.9E+00	2.6E+00		5.70E-07		4E-09		4.68E-08		3E-10		3.03E-08		2.21E-10
Dibenz(a,h)anthracene	N/A	7.3E+00	1.3E-01	7.0E-01	1.5E+00		2.10E-07		2E-06		2.70E-08		2E-07		1.12E-08		8.15E-08
Indeno(1,2,3-cd)pyrene	N/A	7.3E-01	1.3E-01	1.7E+00	2.2E+00		5.10E-07		4E-07		3.96E-08		3E-08		2.71E-08		1.98E-08
Arsenic	3.00E-04	1.5E+00	3E-02	6.3E+00	6.1E+00	1.22E-06	4.36E-07	4E-03	7E-07	1.77E-06	2.53E-08	6E-03	4E-08	2.71E-07	2.32E-08	9.02E-04	3.48E-08
Iron	3.00E-01	N/A	1E-03	2.4E+04	2.4E+04	1.56E-04		5E-04		2.30E-04		8E-04		3.46E-05		1.15E-04	
Total Hazard Quotient and Cancer Risk:								5E-03	1E-05			7E-03	9E-07			1E-03	5E-07
						Assumptions for Industrial Worker			Assumptions for Construction Worker			Assumptions for Child Trespasser					
						CF =	1E-06 kg/mg	EPC Surface Only		CF =	1E-06 kg/mg	EPC Surface and Subsurface		CF =	1E-06 kg/mg	EPC Surface Only	
						CS =				EPC =				EPC =			
						BW =	70 kg			BW =	70 kg			BW =	15 kg		
						SA =	3,300 cm ²			SA =	3,300 cm ²			SA =	2,800 cm ²		
						AF =	0.2 mg/cm ² -event			AF =	0.3 mg/cm ² -event			AF =	0.2 mg/cm ² -event		
						EV =	1 event/day			EV =	1 event/day			EV =	1 event/day		
						EF =	250 days/year			EF =	250 days/year			EF =	14 days/year		
						ED =	25 years			ED =	1 years			ED =	6 years		
						AT (Nc) =	9,125 days			AT (Nc) =	365 days			AT (Nc) =	2,190 days		
						AT (Car) =	25,550 days			AT (Car) =	25,550 days			AT (Car) =	25,550 days		

Note: Cells in this table were intentionally left blank due to a lack of toxicity data.

NA= Information not available.

* Absorption factors from Exhibit 3-4 of USEPA (2004) Supplemental Guidance for Dermal Risk Assessment, Part E of Risk Assessment Guidance for Superfund, Human Health Evaluation Manual (Volume I).

Absorption factor for iron was assumed to be 0.001 in accordance with the USEPA Region 4 (2000)

Supplemental Guidance to RAGS: Region 4 Bulletins, Human Health Risk Assessment Bulletins (<http://www.epa.gov/region4/waste/ots/healthbul.htm>).

**TABLE F-9
CALCULATION OF ABSORBED DOSE AND RISK FROM DERMAL CONTACT TO SOIL
CENTRAL TENDENCY (CT) - SEAD-71 (FENCED AREA EXCLUDED)
SEAD-59 AND SEAD-71 PHASE II RI
Seneca Army Depot Activity**

Equation for Intake (mg/kg-day) =	$EPC \times CF \times SA \times AF \times ABS \times EV \times EF \times ED$ BW x AT
Variables (Assumptions for Each Receptor are Listed at the Bottom):	Equation for Hazard Quotient = Chronic Daily Intake (Nc)/Reference Dose
EPC = Chemical Concentration in Soil, mg/kg	EV = Event Frequency
CF = Conversion Factor	EF = Exposure Frequency
SA = Surface Area Contact	ED = Exposure Duration
AF = Adherence Factor	BW = Bodyweight
ABS = Absorption Factor	AT = Averaging Time
	Equation for Cancer Risk = Chronic Daily Intake (Car) x Slope Factor

Analyte	Dermal RfD (mg/kg-day)	Carc. Slope Dermal (mg/kg-day)-1	Absorption Factor* (unitless)	EPC Surface Soil (mg/kg)	EPC from Total Soils (mg/kg)	Industrial Worker			Construction Worker			Child Trespasser					
						Absorbed Dose (mg/kg-day)		Hazard Quotient	Cancer Risk	Absorbed Dose (mg/kg-day)		Hazard Quotient	Cancer Risk	Absorbed Dose (mg/kg-day)		Hazard Quotient	Cancer Risk
						(Nc)	(Car)			(Nc)	(Car)			(Nc)	(Car)		
Benzo(a)anthracene	N/A	7.3E-01	1.3E-01	2.9E+00	5.5E+00		2.74E-08		2E-08		8.67E-08		6E-08		9.25E-09		6.76E-09
Benzo(a)pyrene	N/A	7.3E+00	1.3E-01	2.7E+00	3.8E+00		2.55E-08		2E-07		5.99E-08		4E-07		8.62E-09		6.29E-08
Benzo(b)fluoranthene	N/A	7.3E-01	1.3E-01	1.6E+00	2.2E+00		1.51E-08		1E-08		3.47E-08		3E-08		5.11E-09		3.73E-09
Benzo(k)fluoranthene	N/A	7.3E-02	1.3E-01	2.4E+00	3.0E+00		2.27E-08		2E-09		4.73E-08		3E-09		7.66E-09		5.59E-10
Chrysene	N/A	7.3E-03	1.3E-01	1.9E+00	2.6E+00		1.80E-08		1E-10		4.10E-08		3E-10		6.06E-09		4.43E-11
Dibenz(a,h)anthracene	N/A	7.3E+00	1.3E-01	7.0E-01	1.5E+00		6.62E-09		5E-08		2.36E-08		2E-07		2.23E-09		1.63E-08
Indeno(1,2,3-cd)pyrene	N/A	7.3E-01	1.3E-01	1.7E+00	2.2E+00		1.61E-08		1E-08		3.47E-08		3E-08		5.43E-09		3.96E-09
Arsenic	3.00E-04	1.5E+00	3.0E-02	6.3E+00	6.1E+00	1.07E-07	1.37E-08	4E-04	2E-08	1.55E-06	2.22E-08	5E-03	3E-08	5.41E-08	4.64E-09	2E-04	7E-09
Iron	3.00E-01	N/A	1E-03	2.4E+04	2.4E+04	1.37E-05		5E-05		2.02E-04		7E-04		6.91E-06		2E-05	
Total Hazard Quotient and Cancer Risk:								4E-04	3E-07			6E-03	8E-07			2E-04	1E-07
						Assumptions for Industrial Worker			Assumptions for Construction Worker			Assumptions for Child Trespasser					
						CF =	1E-06 kg/mg	CF =	1E-06 kg/mg	CF =	1E-06 kg/mg						
						CS =	EPC Surface Only	EPC =	EPC Surface and Subsurface	EPC =	EPC Surface Only						
						BW =	70 kg	BW =	70 kg	BW =	15 kg						
						SA =	3,300 cm ²	SA =	3,300 cm ²	SA =	2,800 cm ²						
						AF =	0.02 mg/cm ² -event	AF =	0.3 mg/cm ² -event	AF =	0.04 mg/cm ² -event						
						EV =	1 event/day	EV =	1 event/day	EV =	1 event/day						
						EF =	219 days/year	EF =	219 days/year	EF =	14 days/year						
						ED =	9 years	ED =	1 years	ED =	6 years						
						AT (Nc) =	3,285 days	AT (Nc) =	365 days	AT (Nc) =	2,190 days						
						AT (Car) =	25,550 days	AT (Car) =	25,550 days	AT (Car) =	25,550 days						

Note: Cells in this table were intentionally left blank due to a lack of toxicity data.

NA= Information not available.

* Absorption factors from Exhibit 3-4 of USEPA (2004) Supplemental Guidance for Dermal Risk Assessment, Part E of Risk Assessment Guidance for Superfund, Human Health Evaluation Manual (Volume I).

Absorption factor for iron was assumed to be 0.001 in accordance with the USEPA Region 4 (2000)

Supplemental Guidance to RAGS: Region 4 Bulletins, Human Health Risk Assessment Bulletins (<http://www.epa.gov/region4/waste/ots/healthbul.htm>).

TABLE F-10
CALCULATION OF INTAKE AND RISK FROM INHALATION OF DUST IN AMBIENT AIR
REASONABLE MAXIMUM EXPOSURE (RME) - SEAD-71 (FENCED AREA EXCLUDED)
SEAD-59 AND SEAD-71 PHASE II RI
Seneca Army Depot Activity

Equation for Intake (mg/kg-day) = $\frac{EPC \times IR \times EF \times ED}{BW \times AT}$	Equation for Hazard Quotient = Chronic Daily Intake (Nc)/Reference Dose
Variables (Assumptions for Each Receptor are Listed at the Bottom): EPC = Exposure Point Concentration in Air, mg/m3 IR = Inhalation Rate EF = Exposure Frequency	Equation for Cancer Risk = Chronic Daily Intake (Car) x Slope Factor
ED = Exposure Duration BW = Bodyweight AT = Averaging Time	

Analyte	Inhalation RID (mg/kg-day)	Carc. Slope Inhalation (mg/kg-day)-1	Air EPC from Surface Soil (mg/m3)	Air EPC from Total Soils (mg/m3)	Industrial Worker			Construction Worker			Child Trespasser					
					Intake (mg/kg-day)		Hazard Quotient	Cancer Risk	Intake (mg/kg-day)		Hazard Quotient	Cancer Risk	Intake (mg/kg-day)		Hazard Quotient	Cancer Risk
					(Nc)	(Car)			(Nc)	(Car)			(Nc)	(Car)		
Benzo(a)anthracene	N/A	N/A	4.9E-08	5.2E-06												
Benzo(a)pyrene	N/A	3.10E+00	4.6E-08	3.6E-06		3.21E-09		1E-08		1.01E-08		3E-08		1.21E-10		4E-10
Benzo(b)fluoranthene	N/A	N/A	2.7E-08	2.1E-06												
Benzo(k)fluoranthene	N/A	N/A	4.1E-08	2.9E-06												
Chrysene	N/A	N/A	3.2E-08	2.5E-06												
Dibenz(a,h)anthracene	N/A	N/A	1.2E-08	1.4E-06												
Indeno(1,2,3-cd)pyrene	N/A	N/A	2.9E-08	2.1E-06												
Arsenic	N/A	1.51E+01	1.1E-07	5.8E-06		7.49E-09		1E-07		1.63E-08		2E-07		2.82E-10		4E-09
Iron	N/A	N/A	4.1E-04	2.3E-02												
Total Hazard Quotient and Cancer Risk:								1E-07				3E-07				5E-09
					Assumptions for Industrial Worker			Assumptions for Construction Worker			Assumptions for Child Trespasser					
					CA =	EPC Surface Only		CA =	EPC Surface and Sub-Surface		CA =	EPC Surface Only				
					BW =	70 kg		BW =	70 kg		BW =	15 kg				
					IR =	20 m3/day		IR =	20 m3/day		IR =	12 m3/day				
					EF =	250 days/year		EF =	250 days/year		EF =	14 days/year				
					ED =	25 years		ED =	1 year		ED =	6 years				
					AT (Nc) =	9,125 days		AT (Nc) =	365 days		AT (Nc) =	2,190 days				
					AT (Car) =	25,550 days		AT (Car) =	25,550 days		AT (Car) =	25,550 days				

Note: Cells in this table were intentionally left blank due to a lack of toxicity data.
 NA= Information not available.

TABLE F-11
CALCULATION OF INTAKE AND RISK FROM INHALATION OF DUST IN AMBIENT AIR
CENTRAL TENDENCY EXPOSURE (CT) - SEAD-71 (FENCED AREA EXCLUDED)
SEAD-59 AND SEAD-71 PHASE II RI
Seneca Army Depot Activity

Equation for Intake (mg/kg-day) = $\frac{EPC \times IR \times EF \times ED}{BW \times AT}$	Equation for Hazard Quotient = Chronic Daily Intake (Nc)/Reference Dose
Variables (Assumptions for Each Receptor are Listed at the Bottom): EPC = Exposure Point Concentration, mg/m3 IR = Inhalation Rate EF = Exposure Frequency	Equation for Cancer Risk = Chronic Daily Intake (Car) x Slope Factor
ED = Exposure Duration BW = Bodyweight AT = Averaging Time	

Analyte	Inhalation RID (mg/kg-day)	Carc. Slope Inhalation (mg/kg-day)-1	Air EPC from Surface Soil (mg/m3)	Air EPC from Total Soils (mg/m3)	Industrial Worker			Construction Worker			Child Trespasser					
					Intake (mg/kg-day)		Hazard Quotient	Cancer Risk	Intake (mg/kg-day)		Hazard Quotient	Cancer Risk	Intake (mg/kg-day)		Hazard Quotient	Cancer Risk
					(Nc)	(Car)			(Nc)	(Car)			(Nc)	(Car)		
Benzo(a)anthracene	N/A	N/A	4.9E-08	5.2E-06												
Benzo(a)pyrene	N/A	3.10E+00	4.6E-08	3.6E-06		5.26E-10		2E-09		8.88E-09		3E-08		1.21E-10		4E-10
Benzo(b)fluoranthene	N/A	N/A	2.7E-08	2.1E-06												
Benzo(k)fluoranthene	N/A	N/A	4.1E-08	2.9E-06												
Chrysene	N/A	N/A	3.2E-08	2.5E-06												
Dibenz(a,h)anthracene	N/A	N/A	1.2E-08	1.4E-06												
Indeno(1,2,3-cd)pyrene	N/A	N/A	2.9E-08	2.1E-06												
Arsenic	N/A	1.51E+01	1.1E-07	5.8E-06		1.23E-09		2E-08		1.43E-08		2E-07		2.82E-10		4E-09
Iron	N/A	N/A	4.1E-04	2.3E-02												
Total Hazard Quotient and Cancer Risk:								2E-08				2E-07				5E-09
					Assumptions for Industrial Worker			Assumptions for Construction Worker			Assumptions for Child Trespasser					
					CA =	EPC Surface Only		CA =	EPC Surface and Sub-Surface		CA =	EPC Surface Only				
					BW =	70 kg		BW =	70 kg		BW =	15 kg				
					IR =	10.4 m3/day		IR =	20 m3/day		IR =	12 m3/day				
					EF =	219 days/year		EF =	219 days/year		EF =	14 days/year				
					ED =	9 years		ED =	1 year		ED =	6 years				
					AT (Nc) =	3,285 days		AT (Nc) =	365 days		AT (Nc) =	2,190 days				
					AT (Car) =	25,550 days		AT (Car) =	25,550 days		AT (Car) =	25,550 days				

Note: Cells in this table were intentionally left blank due to a lack of toxicity data.
 NA= Information not available.

Table F-12
Calculations of Blood Lead Concentration - Industrial Worker Exposed to SEAD-71 Surface Soil (Fenced Area Excluded)
SEAD-59 and SEAD-71 Phase II RI
Seneca Army Depot Activity

Calculations of Blood Lead Concentrations (PbBs)

U.S. EPA Technical Review Workgroup for Lead, Adult Lead Committee

Version date 05/19/03

Exposure Variable	PbB Equation ¹		Description of Exposure Variable	Units	Values for Non-Residential Exposure Scenario			
	1*	2**			Using Equation 1		Using Equation 2	
					GSDi = Hom	GSDi = Het	GSDi = Hom	GSDi = Het
PbS	X	X	Soil lead concentration	ug/g or ppm	115	115	115	115
R _{fetal/maternal}	X	X	Fetal/maternal PbB ratio	--	0.9	0.9	0.9	0.9
BKSF	X	X	Biokinetic Slope Factor	ug/dL per ug/day	0.4	0.4	0.4	0.4
GSD _i	X	X	Geometric standard deviation PbB	--	2.1	2.3	2.1	2.3
PbB ₀	X	X	Baseline PbB	ug/dL	1.5	1.7	1.5	1.7
IR _S	X		Soil ingestion rate (including soil-derived indoor dust)	g/day	0.050	0.050	--	--
IR _{S+D}		X	Total ingestion rate of outdoor soil and indoor dust	g/day	--	--	0.050	0.050
W _S		X	Weighting factor; fraction of IR _{S+D} ingested as outdoor soil	--	--	--	1.0	1.0
K _{SD}		X	Mass fraction of soil in dust	--	--	--	0.7	0.7
AF _{S,D}	X	X	Absorption fraction (same for soil and dust)	--	0.12	0.12	0.12	0.12
EF _{S,D}	X	X	Exposure frequency (same for soil and dust)	days/yr	219	219	219	219
AT _{S,D}	X	X	Averaging time (same for soil and dust)	days/yr	365	365	365	365
PbB_{adult}	PbB of adult worker, geometric mean			ug/dL	1.7	1.9	1.7	1.9
PbB_{fetal, 0.95}	95th percentile PbB among fetuses of adult workers			ug/dL	5.1	6.6	5.1	6.6
PbB_t	Target PbB level of concern (e.g., 10 ug/dL)			ug/dL	10.0	10.0	10.0	10.0
P(PbB_{fetal} > PbB_t)	Probability that fetal PbB > PbB_t, assuming lognormal distribution			%	0.5%	1.6%	0.5%	1.6%
Equation 1 does not apportion exposure between soil and dust ingestion (excludes W _S , K _{SD}). When IR _S = IR _{S+D} and W _S = 1.0, the equations yield the same PbB _{fetal,0.95} .								
*Equation 1, based on Eq. 1, 2 in USEPA (1996).								
PbB_{adult} =		$(PbS * BKSF * IR_{S+D} * AF_{S,D} * EF_S / AT_{S,D}) + PbB_0$						
PbB_{fetal, 0.95} =		$PbB_{adult} * (GSD_1^{1.645} * R)$						
**Equation 2, alternate approach based on Eq. 1, 2, and A-19 in USEPA (1996).								
PbB_{adult} =		$PbS * BKSF * [(IR_{S+D}) * AF_S * EF_S * W_S] + [K_{SD} * (IR_{S+D}) * (1 - W_S) * AF_D * EF_D] / 365 + PbB_0$						
PbB_{fetal, 0.95} =		$PbB_{adult} * (GSD_1^{1.645} * R)$						

Table F-13								
Calculations of Blood Lead Concentration - Construction Worker Exposed to SEAD-71 Surface and Subsurface Soil (Fenced Area Excluded)								
SEAD-59 and SEAD-71 Phase II RI								
Seneca Army Depot Activity								
Calculations of Blood Lead Concentrations (PbBs)								
U.S. EPA Technical Review Workgroup for Lead, Adult Lead Committee								
Version date 05/19/03								
Exposure Variable	PbB Equation ¹		Description of Exposure Variable	Units	Values for Non-Residential Exposure Scenario			
	1*	2**			Using Equation 1		Using Equation 2	
					GSDi = Hom	GSDi = Het	GSDi = Hom	GSDi = Het
PbS	X	X	Soil lead concentration	ug/g or ppm	104.5	104.5	104.5	104.5
R _{fetal/maternal}	X	X	Fetal/maternal PbB ratio	--	0.9	0.9	0.9	0.9
BKSF	X	X	Biokinetic Slope Factor	ug/dL per ug/day	0.4	0.4	0.4	0.4
GSD _i	X	X	Geometric standard deviation PbB	--	2.1	2.3	2.1	2.3
PbB ₀	X	X	Baseline PbB	ug/dL	1.5	1.7	1.5	1.7
IR _S	X		Soil ingestion rate (including soil-derived indoor dust)	g/day	0.100	0.100	--	--
IR _{S+D}		X	Total ingestion rate of outdoor soil and indoor dust	g/day	--	--	0.100	0.100
W _S		X	Weighting factor; fraction of IR _{S+D} ingested as outdoor soil	--	--	--	1.0	1.0
K _{SD}		X	Mass fraction of soil in dust	--	--	--	0.7	0.7
AF _{S,D}	X	X	Absorption fraction (same for soil and dust)	--	0.12	0.12	0.12	0.12
EF _{S,D}	X	X	Exposure frequency (same for soil and dust)	days/yr	219	219	219	219
AT _{S,D}	X	X	Averaging time (same for soil and dust)	days/yr	365	365	365	365
PbB_{adult}	PbB of adult worker, geometric mean			ug/dL	1.8	2.0	1.8	2.0
PbB_{fetal, 0.95}	95th percentile PbB among fetuses of adult workers			ug/dL	5.5	7.1	5.5	7.1
PbB_t	Target PbB level of concern (e.g., 10 ug/dL)			ug/dL	10.0	10.0	10.0	10.0
P(PbB_{fetal} > PbB_t)	Probability that fetal PbB > PbB_t, assuming lognormal distribution			%	0.7%	2.0%	0.7%	2.0%
¹ Equation 1 does not apportion exposure between soil and dust ingestion (excludes W _S , K _{SD}). When IR _S = IR _{S+D} and W _S = 1.0, the equations yield the same PbB _{fetal,0.95} .								
*Equation 1, based on Eq. 1, 2 in USEPA (1996).								
PbB_{adult} =		$(PbS * BKSF * IR_{S+D} * AF_{S,D} * EF_S / AT_{S,D}) + PbB_0$						
PbB_{fetal, 0.95} =		$PbB_{adult} * (GSD_i^{1.645} * R)$						
**Equation 2, alternate approach based on Eq. 1, 2, and A-19 in USEPA (1996).								
PbB_{adult} =		$PbS * BKSF * ((IR_{S+D}) * AF_S * EF_S * W_S) + [K_{SD} * (IR_{S+D}) * (1 - W_S) * AF_D * EF_D] / 365 + PbB_0$						
PbB_{fetal, 0.95} =		$PbB_{adult} * (GSD_i^{1.645} * R)$						

Appendix G

Human Health Risk Assessment Uncertainty Analysis Risk Calculation Tables

- G-1A Occurrence, Distribution, and Selection of Chemicals of Potential Concern in SEAD-59 Soil
- G-1B Occurrence, Distribution, and Selection of Chemicals of Potential Concern in SEAD-59 Groundwater
- G-1C Occurrence, Distribution, and Selection of Chemicals of Potential Concern in SEAD-59 Stockpile Soil
- G-1D Occurrence, Distribution, and Selection of Chemicals of Potential Concern in SEAD-71 Soil (Fenced Area Excluded)
- G-1E Occurrence, Distribution, and Selection of Chemicals of Potential Concern in SEAD-71 Groundwater (Fenced Area Excluded)
- G-2A SEAD-59 Surface Soil – Soil Exposure Point Concentration Summary
- G-2B SEAD-59 Surface and Subsurface Soil – Soil Exposure Point Concentration Summary
- G-2C SEAD-59 Surface Soil – Ambient Air Exposure Point Concentrations
- G-2D SEAD-59 Surface and Subsurface Soil – Ambient Air Exposure Point Concentrations
- G-2E SEAD-59 Groundwater Exposure Point Concentration Summary
- G-2F SEAD-59 Stockpile Soil – Soil Exposure Point Concentration Summary
- G-2G SEAD-59 Stockpile Soil – Ambient Air Exposure Point Concentrations
- G-2H SEAD-71 Surface Soil (Fenced Area Excluded) – Soil Exposure Point Concentration Summary
- G-2I SEAD-71 Surface and Subsurface Soil (Fenced Area Excluded) – Soil Exposure Point Concentration Summary
- G-2J SEAD-71 Surface Soil (Fenced Area Excluded) – Ambient Air Exposure Point Concentrations
- G-2K SEAD-71 Surface and Subsurface Soil (Fenced Area Excluded) – Ambient Air Exposure Point Concentrations
- G-2L SEAD-71 Groundwater Exposure Point Concentration Summary
- G-3 Exposure Factor Assumptions for Adolescent Trespasser
- G-4A Non-Cancer Toxicity Data – Oral/Dermal
- G-4B Non-Cancer Toxicity Data – Inhalation

Appendix G (Continued)

Human Health Risk Assessment Uncertainty Analysis Risk Calculation Tables

- G-4C Cancer Toxicity Data – Oral/Dermal
- G-4D Cancer Toxicity Data – Inhalation
- G-5A Calculation of Intake and Risk from the Ingestion of SEAD-59 Soil – RME
- G-5B Calculation of Intake and Risk from the Ingestion of SEAD-59 Stockpile Soil – RME
- G-5C Calculation of Intake and Risk from the Ingestion of SEAD-71 Soil (Fenced Area Excluded) – RME
- G-6A Calculation of Absorbed Dose and Risk from Dermal Contact to SEAD-59 Soil – RME
- G-6B Calculation of Absorbed Dose and Risk from Dermal Contact to SEAD-59 Stockpile Soil – RME
- G-6C Calculation of Absorbed Dose and Risk from Dermal Contact to SEAD-71 Soil (Fenced Area Excluded) – RME
- G-7A Calculation of intake and Risk from Inhalation of SEAD-59 Dust in Ambient Air – RME
- G-7B Calculation of intake and Risk from Inhalation of SEAD-59 Stockpile Dust in Ambient Air – RME
- G-7C Calculation of intake and Risk from Inhalation of SEAD-71 Dust in Ambient Air (Fenced Area Excluded) – RME
- G-8A Calculation of Absorbed Dose and Risk from Dermal Contact to SEAD-59 Groundwater – RME
- G-8B Calculation of Absorbed Dose and Risk from Dermal Contact to SEAD-71 Groundwater – RME
- G-9A Calculation of Intake and Risk from the Intake of SEAD-59 Groundwater – RME
- G-9B Calculation of Intake and Risk from the Intake of SEAD-71 Groundwater – RME

**TABLE G-1A
OCCURRENCE, DISTRIBUTION AND SELECTION OF CHEMICALS OF POTENTIAL CONCERN IN SEAD-59 SITE SOIL
SEAD-59 AND SEAD-71 PHASE II RI
Seneca Army Depot Activity**

Scenario Time frame:	Cuurent/Future
Medium:	Soil
Exposure Medium:	Soil
Exposure Point:	SEAD-59

CAS Number	Chemical	Minimum Detected Concentration ¹ (mg/kg)	Q	Maximum Detected Concentration ¹ (mg/kg)	Q	Location of Maximum Concentration	Detection Frequency ¹	Range of Reporting Limits ¹ (mg/kg)	Concentration Used for Screening ² (mg/kg)	Background Value ³ (mg/kg)	Screening Value ⁴ (mg/kg)	Potential ARAR/TBC Source	ARAR / TBC Value ⁵ (mg/kg)	COPC Flag	Rationale for Contaminant Deletion or Selection ⁶
VOC															
75-35-4	1,1-Dichloroethene	0.001	J	0.008	J	CL-59-01-WS5	3 / 198	0.004 - 0.12	0.008		12	NYSDEC TAGM 4046	0.4	NO	BSL
67-64-1	Acetone	0.004	J	0.55	NJ	CL-59-01-WE4	47 / 198	0.004 - 0.12	0.55		1,400	NYSDEC TAGM 4046	0.2	NO	BSL
71-43-2	Benzene	0.001	J	0.0058	J	SB59-17	8 / 198	0.004 - 0.12	0.0058		0.64	NYSDEC TAGM 4046	0.06	NO	BSL
75-15-0	Carbon disulfide	0.001	J	0.004	J	SB59-4	6 / 198	0.004 - 0.12	0.004		36	NYSDEC TAGM 4046	2.7	NO	BSL
110-82-7	Cyclohexane	0.001	J	0.003	J	WS-59-04-010-5	8 / 98	0.004 - 0.023	0.003		14			NO	BSL
100-41-4	Ethyl benzene	0.0023	J	0.11	J	TP59-13A-1	4 / 198	0.004 - 0.055	0.11		400	NYSDEC TAGM 4046	5.5	NO	BSL
	Meta/Para Xylene	0.0051	J	0.0084	J	WS-59-03-001-2	3 / 70	0.0054 - 0.006	0.0084		27			NO	BSL
79-20-9	Methyl Acetate	0.001	J	0.002	J	CL-59-OTHERB-WE1	3 / 98	0.004 - 0.023	0.002		2,200			NO	BSL
74-87-3	Methyl chloride	0.003	J	0.003	J	TP59-5	1 / 128	0.004 - 0.12	0.003		4.7			NO	BSL
108-87-2	Methyl cyclohexane	0.001	J	0.005	J	WS-59-04-010-5	10 / 98	0.004 - 0.023	0.005		260			NO	BSL
78-93-3	Methyl ethyl ketone	0.002	J	0.19	J	CL-59-01-WE4	25 / 198	0.004 - 0.12	0.19		2,200	NYSDEC TAGM 4046	0.3	NO	BSL
108-10-1	Methyl isobutyl ketone	0.0019	J	0.0019	J	CL-59-OTHERC-WS1	1 / 198	0.004 - 0.12	0.0019		530	NYSDEC TAGM 4046	1	NO	BSL
75-09-2	Methylene chloride	0.001	J	0.0049	J	WS-59-01-018-1	37 / 199	0.004 - 0.12	0.0049		9.1	NYSDEC TAGM 4046	0.1	NO	BSL
95-47-6	Ortho Xylene	0.0011	NJ	0.0036	J	FD-59-WS-01/WS-59-03-001-3	3 / 70	0.0054 - 0.006	0.0036		27			NO	BSL
127-18-4	Tetrachloroethene	0.002	J	0.0064		WS-59-01-017-1	5 / 198	0.004 - 0.12	0.0064		0.48	NYSDEC TAGM 4046	1.4	NO	BSL
108-88-3	Toluene	0.0009	J	0.011	J	SB59-17	17 / 198	0.004 - 0.12	0.011		520	NYSDEC TAGM 4046	1.5	NO	BSL
	Total BTEX	0.0025		0.0095		TP59-13C-1	16 / 18	1.25 - 1.25	0.0095					NO	ICE
133-02-07	Total Xylenes	0.001	J	0.073	J	SB59-17	8 / 123	0.004 - 0.12	0.073		27	NYSDEC TAGM 4046	1.2	NO	BSL
79-01-6	Trichloroethene	0.001	J	0.0045	J	WS-59-01-006-4	8 / 198	0.004 - 0.12	0.0045		0.053	NYSDEC TAGM 4046	0.7	NO	BSL
75-69-4	Trichlorofluoromethane	0.006	J	0.006	J	WS-59-04-010-6	1 / 98	0.004 - 0.023	0.006		39			NO	BSL
SVOC															
92-52-4	1,1'-Biphenyl	0.059	NJ	0.15	J	FD-59-W5-6/WS-59-01-012-1	2 / 99	0.35 - 1.9	0.15		300			NO	BSL
91-57-6	2-Methylnaphthalene	0.01	J	10		TP59-13A-1	46 / 199	0.066 - 4	10		31	NYSDEC TAGM 4046	36.4	NO	BSL
106-47-8	4-Chloroaniline	0.13	J	1.2		CL-59-01-WN2	2 / 199	0.066 - 8	1.2		24	NYSDEC TAGM 4046	0.22	NO	BSL
106-44-5	4-Methylphenol	0.024	NJ	0.15	J	CL-59-01-WN5	7 / 199	0.066 - 8	0.15		31	NYSDEC TAGM 4046	0.9	NO	BSL
83-32-9	Acenaphthene	0.0061	J	2.68	J	FD-59-WS-07/WS-59-01-015-13	54 / 199	0.066 - 4	2.68		370	NYSDEC TAGM 4046	50	NO	BSL
208-96-8	Acenaphthylene	0.0079	J	1.7	J	WS-59-01-006-11	76 / 199	0.066 - 8	1.7			NYSDEC TAGM 4046	41	NO	NSV
120-12-7	Anthracene	0.0084	J	4.395	J	FD-59-WS-07/WS-59-01-015-13	87 / 199	0.066 - 8	4.395		2,200	NYSDEC TAGM 4046	50	NO	BSL
1912-24-9	Atrazine	0.12	J	0.12	J	CL-59-01-WN2	1 / 99	0.35 - 1.9	0.12		0.22			NO	BSL
100-52-7	Benzaldehyde	0.05	J	0.05	J	CL-59-01-WE4	1 / 99	0.35 - 1.9	0.05		610			NO	BSL

**TABLE G-1A
OCCURRENCE, DISTRIBUTION AND SELECTION OF CHEMICALS OF POTENTIAL CONCERN IN SEAD-59 SITE SOIL
SEAD-59 AND SEAD-71 PHASE II RI
Seneca Army Depot Activity**

Scenario Time frame:	Cuurent/Future
Medium:	Soil
Exposure Medium:	Soil
Exposure Point:	SEAD-59

CAS Number	Chemical	Minimum Detected Concentration ¹ (mg/kg)	Q	Maximum Detected Concentration ¹ (mg/kg)	Q	Location of Maximum Concentration	Detection Frequency ¹	Range of Reporting Limits ¹ (mg/kg)	Concentration Used for Screening ² (mg/kg)	Background Value ³ (mg/kg)	Screening Value ⁴ (mg/kg)	Potential ARAR/TBC Source	ARAR / TBC Value ⁵ (mg/kg)	COPC Flag	Rationale for Contaminant Deletion or Selection ⁶
56-55-3	Benzo(a)anthracene	0.0038	J	8.9	J	FD-59-WS-07/WS-59-01-015-13	104 / 199	0.069 - 8	8.9		0.62	NYSDEC TAGM 4046	0.224	YES	ASL
50-32-8	Benzo(a)pyrene	0.0036	J	8.05	J	FD-59-WS-07/WS-59-01-015-13	105 / 199	0.069 - 8	8.05		0.062	NYSDEC TAGM 4046	0.061	YES	ASL
205-99-2	Benzo(b)fluoranthene	0.0038	J	6.8	J	FD-59-WS-07/WS-59-01-015-13	108 / 199	0.078 - 8	6.8		0.62	NYSDEC TAGM 4046	1.1	YES	ASL
191-24-2	Benzo(ghi)perylene	0.0063	J	5.2	J	FD-59-WS-07/WS-59-01-015-13	95 / 199	0.069 - 8	5.2			NYSDEC TAGM 4046	50	NO	NSV
207-08-9	Benzo(k)fluoranthene	0.0037	J	7.35	J	FD-59-WS-07/WS-59-01-015-13	101 / 199	0.069 - 8	7.35		6.2	NYSDEC TAGM 4046	1.1	YES	ASL
117-81-7	Bis(2-Ethylhexyl)phthalate	0.007	J	0.52	J	SB59-1	49 / 199	0.35 - 8	0.52		35	NYSDEC TAGM 4046	50	NO	BSL
85-68-7	Butylbenzylphthalate	0.0042	J	1	J	TP59-15-5	2 / 199	0.066 - 8	1		1,200	NYSDEC TAGM 4046	50	NO	BSL
86-74-8	Carbazole	0.0066	J	1.5	J	TP59-2	31 / 129	0.069 - 8	1.5		24			NO	BSL
218-01-9	Chrysene	0.0048	J	8.9	J	FD-59-WS-07/WS-59-01-015-13	106 / 199	0.069 - 8	8.9		62	NYSDEC TAGM 4046	0.4	YES	CSG
53-70-3	Dibenz(a,h)anthracene	0.0047	J	1.665	J	FD-59-WS-07/WS-59-01-015-13	76 / 199	0.066 - 8	1.665		0.062	NYSDEC TAGM 4046	0.014	YES	ASL
132-64-9	Dibenzofuran	0.0056	J	1.875	J	FD-59-WS-07/WS-59-01-015-13	38 / 199	0.066 - 4	1.875		15	NYSDEC TAGM 4046	6.2	NO	BSL
84-66-2	Diethylphthalate	0.0053	J	0.012	J	SB59-9	9 / 199	0.078 - 8	0.012		4,900	NYSDEC TAGM 4046	7.1	NO	BSL
84-74-2	Di-n-butylphthalate	0.0048	J	0.49	J	SB59-1	13 / 199	0.076 - 8	0.49		610	NYSDEC TAGM 4046	8.1	NO	BSL
117-84-0	Di-n-octylphthalate	0.0056	J	0.011	J	SB59-8	2 / 199	0.066 - 8	0.011		240	NYSDEC TAGM 4046	50	NO	BSL
206-44-0	Fluoranthene	0.0048	J	23.5	J	FD-59-WS-07/WS-59-01-015-13	112 / 199	0.069 - 8	23.5		230	NYSDEC TAGM 4046	50	NO	BSL
86-73-7	Fluorene	0.0086	J	3	J	TP59-13A-1	60 / 199	0.066 - 4	3		270	NYSDEC TAGM 4046	50	NO	BSL
193-39-5	Indeno(1,2,3-cd)pyrene	0.006	J	4.95	J	FD-59-WS-07/WS-59-01-015-13	97 / 199	0.069 - 8	4.95		0.62	NYSDEC TAGM 4046	3.2	YES	ASL
91-20-3	Naphthalene	0.01	J	1.325	J	FD-59-WS-07/WS-59-01-015-13	44 / 199	0.066 - 8	1.325		5.6	NYSDEC TAGM 4046	13	NO	BSL
86-30-6	N-Nitrosodiphenylamine	0.1	J	0.1	J	CL-59-01-WN2	1 / 129	0.066 - 8	0.1		99			NO	BSL
85-01-8	Phenanthrene	0.0046	J	21.3	J	FD-59-WS-07/WS-59-01-015-13	107 / 199	0.069 - 0.46	21.3			NYSDEC TAGM 4046	50	NO	NSV
108-95-2	Phenol	0.017	J	0.017	J	TP59-6-2	1 / 199	0.066 - 8	0.017		1,800	NYSDEC TAGM 4046	0.03	NO	BSL

**TABLE G-1A
OCCURRENCE, DISTRIBUTION AND SELECTION OF CHEMICALS OF POTENTIAL CONCERN IN SEAD-59 SITE SOIL
SEAD-59 AND SEAD-71 PHASE II RI
Seneca Army Depot Activity**

Scenario Time frame:	Cuurent/Future
Medium:	Soil
Exposure Medium:	Soil
Exposure Point:	SEAD-59

CAS Number	Chemical	Minimum Detected Concentration ¹ (mg/kg)	Q	Maximum Detected Concentration ¹ (mg/kg)	Q	Location of Maximum Concentration	Detection Frequency ¹	Range of Reporting Limits ¹ (mg/kg)	Concentration Used for Screening ² (mg/kg)	Background Value ³ (mg/kg)	Screening Value ⁴ (mg/kg)	Potential ARAR/TBC Source	ARAR / TBC Value ⁵ (mg/kg)	COPC Flag	Rationale for Contaminant Deletion or Selection ⁶
129-00-0	Pyrene	0.0051	J	19.2	J	FD-59-WS-07/WS-59-01-015-13	114 / 198	0.069 - 8	19.2		230	NYSDEC TAGM 4046	50	NO	BSL
PCB															
11096-82-5	Aroclor-1260	0.077		0.079	NJ	CL-59-OTHERC-WE2	2 / 199	0.035 - 0.42	0.079		0.22	NYSDEC TAGM 4046	10	NO	BSL
Pesticides															
72-54-8	4,4'-DDD	0.0025	J	0.74	J	CL-59-01-WN2	55 / 199	0.0034 - 0.099	0.74		2.4	NYSDEC TAGM 4046	2.9	NO	BSL
72-55-9	4,4'-DDE	0.0018	J	2.6		CL-59-01-WN2	75 / 199	0.0034 - 0.099	2.6		1.7	NYSDEC TAGM 4046	2.1	YES	ASL
50-29-3	4,4'-DDT	0.0024	J	3.7		CL-59-01-WN2	66 / 199	0.0034 - 0.099	3.7		1.7	NYSDEC TAGM 4046	2.1	YES	ASL
309-00-2	Aldrin	0.0012	J	0.0012	J	SB59-2	1 / 199	0.0018 - 0.22	0.0012		0.029	NYSDEC TAGM 4046	0.041	NO	BSL
319-84-6	Alpha-BHC	0.009		0.0099	J	MW59-4	2 / 199	0.0018 - 0.22	0.0099		0.09	NYSDEC TAGM 4046	0.11	NO	BSL
5103-71-9	Alpha-Chlordane	0.0011	J	0.034	J	WS-59-04-010-10	9 / 199	0.0018 - 0.22	0.034		1.6			NO	BSL
319-85-7	Beta-BHC	0.0024	J	0.0036	J	SB59-8	6 / 199	0.0018 - 0.22	0.0036		0.32	NYSDEC TAGM 4046	0.2	NO	BSL
319-86-8	Delta-BHC	0.00095	J	0.0014	J	SB59-8	4 / 199	0.0018 - 0.22	0.0014		0.09	NYSDEC TAGM 4046	0.3	NO	BSL
60-57-1	Dieldrin	0.0018	J	0.0018	J	TP59-8-2	1 / 199	0.0034 - 0.43	0.0018		0.030	NYSDEC TAGM 4046	0.044	NO	BSL
959-98-8	Endosulfan I	0.0041	J	0.016	J	SB59-2	2 / 199	0.0018 - 0.22	0.016		37	NYSDEC TAGM 4046	0.9	NO	BSL
33213-65-9	Endosulfan II	0.0071	J	0.0071	J	TP59-2	1 / 199	0.0034 - 0.43	0.0071		37	NYSDEC TAGM 4046	0.9	NO	BSL
1031-07-8	Endosulfan sulfate	0.0043	J	0.0062	J	CL-59-OTHERC-WE2	2 / 199	0.0034 - 0.43	0.0062		37	NYSDEC TAGM 4046	1	NO	BSL
72-20-8	Endrin	0.0038	NJ	0.016	NJ	CL-59-04-FO1	4 / 199	0.0034 - 0.43	0.016		1.8	NYSDEC TAGM 4046	0.1	NO	BSL
7421-93-4	Endrin aldehyde	0.0035	J	0.0063	J	TP59-2	5 / 199	0.0034 - 0.43	0.0063		1.8			NO	BSL
53494-70-5	Endrin ketone	0.0033	J	0.038		WS-59-01-011-3	5 / 199	0.0034 - 0.43	0.038		1.8			NO	BSL
5103-74-2	Gamma-Chlordane	0.001	J	0.024	J	WS-59-04-010-10	16 / 199	0.0018 - 0.22	0.024		1.6	NYSDEC TAGM 4046	0.54	NO	BSL
1024-57-3	Heptachlor epoxide	0.001	J	0.0057	J	TP59-6-2	5 / 199	0.0018 - 0.22	0.0057		0.053	NYSDEC TAGM 4046	0.02	NO	BSL
Metals															
7429-90-5	Aluminum	4,200		18,300	J	CL-59-01-F12	199 / 199		18,300	20,500	7,600	NYSDEC TAGM 4046	19,300	YES	ASL
7440-36-0	Antimony	0.24	J	424	J	SB59-4	107 / 199	0.14 - 3.62	424	6.55	3.1	NYSDEC TAGM 4046	5.9	YES	ASL
7440-38-2	Arsenic	2.3	J	32.2		CL-59-01-WN2	199 / 199		32.2	21.5	0.39	NYSDEC TAGM 4046	8.2	YES	ASL
7440-39-3	Barium	21.1	J	304		SB59-4	199 / 199		304	159	540	NYSDEC TAGM 4046	300	NO	BSL
7440-41-7	Beryllium	0.11	J	2.6		CL-59-01-WN2	197 / 199	0.05 - 0.045	2.6	1.4	15	NYSDEC TAGM 4046	1.1	NO	BSL
7440-43-9	Cadmium	0.1	J	3.2		SB59-4	158 / 199	0.07 - 0.15	3.2	2.9	3.7	NYSDEC TAGM 4046	2.3	NO	BSL
7440-70-2	Calcium	1,350	J	214,000		SB59-4	199 / 199		214,000	293,000	2,500,000	NYSDEC TAGM 4046	121,000	NO	NUT
7440-47-3	Chromium	7.4	J	39.3	J	CL-59-01-WN2	199 / 199		39.3	32.7	210	NYSDEC TAGM 4046	29.6	NO	BSL
7440-48-4	Cobalt	3.8	J	47.8		CL-59-01-WN2	199 / 199		47.8	29.1	900	NYSDEC TAGM 4046	30	NO	BSL
7440-50-8	Copper	9.8	J	305		WS-59-01-013-5	199 / 199		305	62.8	310	NYSDEC TAGM 4046	33	NO	BSL
7439-89-6	Iron	6,540		64,000	J	CL-59-01-WN2	199 / 199		64,000	38,600	2,300	NYSDEC TAGM 4046	36,500	YES	ASL
7439-92-1	Lead	4.1	J	164		WS-59-01-006-8	199 / 199		164	266	400	NYSDEC TAGM 4046	24.8	NO	BSL
7439-95-4	Magnesium	2,530		34,400		SB59-5	199 / 199		34,400	29,100	400,000	NYSDEC TAGM 4046	21,500	NO	NUT

**TABLE G-1A
OCCURRENCE, DISTRIBUTION AND SELECTION OF CHEMICALS OF POTENTIAL CONCERN IN SEAD-59 SITE SOIL
SEAD-59 AND SEAD-71 PHASE II RI
Seneca Army Depot Activity**

Scenario Time frame:	Cuurent/Future
Medium:	Soil
Exposure Medium:	Soil
Exposure Point:	SEAD-59

CAS Number	Chemical	Minimum Detected Concentration ¹ (mg/kg)	Q	Maximum Detected Concentration ¹ (mg/kg)	Q	Location of Maximum Concentration	Detection Frequency ¹	Range of Reporting Limits ¹ (mg/kg)	Concentration Used for Screening ² (mg/kg)	Background Value ³ (mg/kg)	Screening Value ⁴ (mg/kg)	Potential ARAR/TBC Source	ARAR / TBC Value ⁵ (mg/kg)	COPC Flag	Rationale for Contaminant Deletion or Selection ⁶
7439-96-5	Manganese	156	J	1,290	J	CL-59-01-WS6	199 / 199		1,290	2,380	180	NYSDEC TAGM 4046	1,060	YES	ASL
7439-97-6	Mercury	0.02	J	0.95	J	WS-59-04-010-6	179 / 198	0.02 - 0.03	0.95	0.13	2.3	NYSDEC TAGM 4046	0.1	NO	BSL
7440-02-0	Nickel	9	J	88.3	J	CL-59-01-WN2	199 / 199		88.3	62.3	160	NYSDEC TAGM 4046	49	NO	BSL
7440-09-7	Potassium	539	J	2,520	J	SB59-1	199 / 199		2,520	3,160	5,000,000	NYSDEC TAGM 4046	2,380	NO	NUT
7782-49-2	Selenium	0.28	J	1.5	J	SB59-21	21 / 199	0.12 - 0.58	1.5	1.7	39	NYSDEC TAGM 4046	2	NO	BSL
7440-22-4	Silver	0.11	J	2.9	J	CL-59-OTHERA-WN1	88 / 199	0.08 - 0.31	2.9	0.87	39	NYSDEC TAGM 4046	0.75	NO	BSL
7440-23-5	Sodium	33.3	J	4,060	J	CL-59-01-WE5	194 / 199	83.1 - 57.5	4,060	269	1,125,000	NYSDEC TAGM 4046	172	NO	NUT
7440-28-0	Thallium	0.11	J	1.8	J	CL-59-03-WS3	51 / 199	0.18 - 0.75	1.8	1.2	0.52	NYSDEC TAGM 4046	0.7	YES	ASL
7440-62-2	Vanadium	8.4	J	28.5	J	CL-59-01-F12	199 / 199		28.5	32.7	7.8	NYSDEC TAGM 4046	150	YES	ASL
7440-66-6	Zinc	19.6	J	341	J	SB59-4	199 / 199		341	126	2,300	NYSDEC TAGM 4046	110	NO	BSL

Notes:

- Field duplicates were treated as discrete samples. Laboratory duplicates were not included in the assessment. Range of reporting limits were presented for nondetects only.
- The maximum detected concentration was used for screening.
- Background value is the maximum Seneca background concentration.
- EPA Region 9 Preliminary Remediation Goals (PRGs) for residential soil. On-line resources available at <http://www.epa.gov/region09/waste/sfund/prg/files/prgtable2004.xls>. Last updated October 2004.
Region 9 PRGs were derived based on Direct contact exposure (ingestion and dermal contact) and a target Cancer Risk of 1E-6 or a Target Hazard Quotient of 1.
EPA Region III Risk Based Concentration (RBC) for residential soil was used as screening value for 2-methylnaphthalene as no Region 9 PRG is available. EPA Region III RBC, available on-line at <http://www.epa.gov/reg3hwmd/risk/human/rbc/rbc1004.XLS>, was calculated based on soil ingestion exposure and a target cancer risk of 1E-6 and a target hazard quotient of 1.
The PRGs or RBCs corresponding to a hazard quotient of 1 were adjusted by multiplying 0.1 before they were used as screening values.
PRG for xylenes was used as screening value for meta/para xylenes and ortho xylene.
PRG for Aroclor 1254 was used as screening value for Aroclor 1260.
PRG for gamma-chlordane was used as screening value for alpha-chlordane.
PRG for alpha-BHC was used as screening value for delta-BHC.
PRG for endosulfan was used as screening value for endosulfan I, endosulfan II, and endosulfan sulfate.
PRG for endrin was used as screening value for endrin aldehyde and endrin ketone.
Screening values for calcium, magnesium, potassium, and sodium were calculated based on an assumption of 200 mg/day soil ingestion and recommended dietary allowances and adequate intakes for 1-3 yr children (500 mg/day and 80 mg/day for calcium and magnesium) and minimum requirements for 1 yr children (225 mg/day and 1000 mg/day for sodium and potassium) from Marilyn Wright (2001) Dietary Reference Intakes.
PRG for total chromium (1:6 ratio Cr VI: Cr III) was used as screening value for chromium.
PRG for nickel (soluble salts) was used as screening value for nickel.
- Potential ARAR/TBC values are from NYSDEC Technical and Administrative Guidance Memorandum #4046 (on-line resources available at <http://www.dec.state.ny.us/website/der/tagms/prtg4046.html>)
- Rationale codes

Selection Reason:	Above Screening Levels (ASL)
	Chemicals in the Same Group were retained as COPC (CSG)
Deletion Reason:	Essential Nutrient (NUT)
	Below Screening Level (BSL)
	No Screening Value or Toxicity Value (NSV)

TABLE G-1A
OCCURRENCE, DISTRIBUTION AND SELECTION OF CHEMICALS OF POTENTIAL CONCERN IN SEAD-59 SITE SOIL
SEAD-59 AND SEAD-71 PHASE II RI
Seneca Army Depot Activity

Scenario Time frame:	Cuurent/Future
Medium:	Soil
Exposure Medium:	Soil
Exposure Point:	SEAD-59

CAS Number	Chemical	Minimum Detected Concentration ¹ (mg/kg)	Q	Maximum Detected Concentration ¹ (mg/kg)	Q	Location of Maximum Concentration	Detection Frequency ¹	Range of Reporting Limits ¹ (mg/kg)	Concentration Used for Screening ² (mg/kg)	Background Value ³ (mg/kg)	Screening Value ⁴ (mg/kg)	Potential ARAR/TBC Source	ARAR / TBC Value ⁵ (mg/kg)	COPC Flag	Rationale for Contaminant Deletion or Selection ⁶
------------	----------	--	---	--	---	-----------------------------------	----------------------------------	---	--	--	---	---------------------------	--	-----------	--

Individual Chemicals Evaluated (ICE)

Definitions:

COPC = Chemical of Potential Concern

ARAR/TBC = Applicable or Relevant and Appropriate Requirement/To Be Considered

Q = Qualifier

J = Estimated Value

NJ = Presence of the analyte has been "tentatively identified" and the associated numerical value represents its approximate concentration.

**TABLE G-1B
OCCURRENCE, DISTRIBUTION AND SELECTION OF CHEMICALS OF POTENTIAL CONCERN IN SEAD-59 SITE GROUNDWATER
SEAD-59 AND SEAD-71 PHASE II RI
SENECA ARMY DEPOT ACTIVITY**

Scenario Timeframe:	Current/Future
Medium:	Groundwater
Exposure Medium:	Groundwater
Exposure Point:	Aquifer -- Tap Water

CAS Number	Chemical	Minimum Detected Concentration ¹ (ug/L)	Q	Maximum Detected Concentration ¹ (ug/L)	Q	Location of Maximum Concentration	Detection Frequency ¹	Range of Reporting Limits ¹ (ug/L)	Concentration Used for Screening ² (ug/L)	Background Value ³ (ug/L)	Screening Value ⁴ (ug/L)	Potential ARAR /TBC Value (ug/L)	Potential ARAR/TBC Source	COPC Flag	Rationale for Contaminant Deletion or Selection ⁵
VOC															
71-55-6	1,1,1-Trichloroethane	0.45	J	0.45	J	MW59-3	1 / 13	0.5 - 10	0.45		320	5	GA	NO	BSL
108-88-3	Toluene	0.27	J	0.27	J	MW59-3	1 / 13	0.5 - 10	0.27		72	5	GA	NO	BSL
SVOC															
84-74-2	Di-n-butylphthalate	2.3	J	2.3	J	MW59-7	1 / 13	9.7 - 11	2.3		360	50	GA	NO	BSL
108-95-2	Phenol	1	J	2	J	MW59-2	2 / 13	9.7 - 10.8	2		1,100	1	GA	NO	BSL
Pesticides															
72-55-9	4,4'-DDE	0.008	J	0.008	J	MW59-1	2 / 10	0.04 - 0.04	0.008		0.20	0.2	GA	NO	BSL
50-29-3	4,4'-DDT	0.042	J	0.042	J	MW59-3	1 / 10	0.04 - 0.04	0.042		0.20	0.2	GA	NO	BSL
Metals															
7429-90-5	Aluminum	26.8	J	3,250		MW59-6	12 / 13	14.7 - 14.7	3,250	2,730	3,600	50	SEC	NO	BSL
7440-36-0	Antimony	5.49	J	8.6	J	MW59-3	4 / 13	0.99 - 10	8.6	8.2	1.5	3	GA	YES	ASL
7440-38-2	Arsenic	2	J	2	J	MW59-1	1 / 13	2 - 22.4	2	1.7	0.045	10	MCL	YES	ASL
7440-39-3	Barium	54.7		132		MW59-2	13 / 13		132	78.2	260	1,000	GA	NO	BSL
7440-43-9	Cadmium	0.335	J	0.9	J	MW59-3	4 / 13	0.1 - 5	0.9	0.5	1.8	5	GA	NO	BSL
7440-70-2	Calcium	102,000		169,000		MW59-3	13 / 13		169,000	116,000	250,000			NO	NUT
7440-47-3	Chromium	0.53	J	3.6	J	MW59-3	8 / 13	0.5 - 5	3.6	4.7	11	50	GA	NO	BSL
7440-48-4	Cobalt	0.68	J	3.5	J	MW59-1	7 / 13	0.54 - 5	3.5	3.7	73			NO	BSL
7440-50-8	Copper	1.42	J	4.65	J	MW59-6	6 / 13	0.5 - 5	4.65	3.3	150	200	GA	NO	BSL
7439-89-6	Iron	60.9	J	3,940	J	MW59-3	13 / 13		3,940	4,480	1,100	300	GA	YES	ASL
7439-92-1	Lead	1.5	J	4.4	J	MW59-7	6 / 13	0.9 - 5	4.4	2.5	15	15	MCL	NO	BSL
7439-95-4	Magnesium	12,800		29,200		MW59-2	13 / 13		29,200	28,600	40,000			NO	NUT
7439-96-5	Manganese	9.11		780		MW59-1	13 / 13		780	224	88	50	SEC	YES	ASL
7439-97-6	Mercury	0.05	J	0.06	J	MW59-3	2 / 13	0.03 - 0.2	0.06	0.04	1.1	0.7	GA	NO	BSL
7440-02-0	Nickel	0.812	J	7.6	J	MW59-1	10 / 13	0.69 - 5	7.6	7.3	73	100	GA	NO	BSL
7440-09-7	Potassium	817	J	4150	J	MW59-3	13 / 13		4,150	3,830	700,000			NO	NUT
7782-49-2	Selenium	4.2	J	4.2	J	MW59-8	1 / 10	1.7 - 5	4.2	1.5	18	10	GA	NO	BSL
7440-23-5	Sodium	22,000		304,000		MW59-3	13 / 13		304,000	14,600	1,200,000	20,000	GA	NO	NUT
7440-28-0	Thallium	2.8	J	4	J	MW59-2	2 / 13	1.6 - 20	4	1.5	0.24	2	MCL	YES	ASL
7440-62-2	Vanadium	1.1	J	5.26		MW59-6	5 / 13	0.61 - 5	5.26	5.2	3.6			YES	ASL
7440-66-6	Zinc	1.5	J	26.2		MW59-3	13 / 13		26.2	23.1	1,100	5,000	SEC	NO	BSL

**TABLE G-1B
OCCURRENCE, DISTRIBUTION AND SELECTION OF CHEMICALS OF POTENTIAL CONCERN IN SEAD-59 SITE GROUNDWATER
SEAD-59 AND SEAD-71 PHASE II RI
SENECA ARMY DEPOT ACTIVITY**

Notes:

1. Field duplicates were averaged and regarded as one sample entry. Laboratory duplicates were not included in the assessment. Range of reporting limits were presented for nondetects only.
2. The maximum detected concentration was used for screening.
3. Background values are average concentrations of background sample results.
4. EPA Region 9 Preliminary Remediation Goals (PRGs) for tap water. On-line resources available at <http://www.epa.gov/region09/waste/sfund/prg/files/prgtable2004.xls>. Last updated October 2004.
Region 9 PRGs were derived based on ingestion and inhalation exposure and a target Cancer Risk of 1E-6 or a Target Hazard Quotient of 1. The PRGs corresponding to a hazard quotient of 1 was adjusted by multiplying 0.1 before they were used as screening values. MCL for lead was used as screening value for lead as no Region 9 PRG is available. PRG for endrin was used as screening value for endrin ketone. Screening values for calcium, magnesium, potassium, and sodium were calculated based on an assumption of 2L/day water intake and recommended dietary allowances and adequate intakes for 1-3 yr children (500 mg/day and 80 mg/day for calcium and magnesium) and minimum requirements for 2-5 yr children (1400 mg/day for potassium) from Marilyn Wright (2001) Dietary Reference Intakes. For sodium, an upper limit intake of 2,400 mg/day (<http://www.mealformation.com/dailyval.html>) was used. PRG for chromium (VI) was used as screening value for chromium.
5. Rationale codes

Selection Reason:	Above Screening Levels (ASL)
Deletion Reason:	Essential Nutrient (NUT)
	Below Screening Level (BSL)

Definitions:

COPC = Chemical of Potential Concern
 ARAR/TBC = Applicable or Relevant and Appropriate Requirement/To Be Considered
 MCL = Federal Maximum Contaminant Level
 GA = New York State Class GA Groundwater Standard (TOGS 1.1.1, June 1998 with updates)
 SEC = USEPA Secondary Drinking Water Regulation, non-enforceable (EPA 822-B-00-001, Summer 2000)
 Q = Qualifier
 J = Estimated Value

**TABLE G-1C
OCCURRENCE, DISTRIBUTION AND SELECTION OF CHEMICALS OF POTENTIAL CONCERN IN SEAD-59 STOCKPILE SOIL
SEAD-59 AND SEAD-71 PHASE II RI
Seneca Army Depot Activity**

Scenario Time frame:	Current/Future
Medium:	Soil
Exposure Medium:	Soil
Exposure Point:	SEAD-59 Stockpile

CAS Number	Chemical	Minimum Detected Concentration ¹ (mg/kg)	Q	Maximum Detected Concentration ¹ (mg/kg)	Q	Location of Maximum Concentration	Detection Frequency ¹	Range of Reporting Limits ¹ (mg/kg)	Concentration Used for Screening ² (mg/kg)	Background Value ³ (mg/kg)	Screening Value ⁴ (mg/kg)	ARAR /TBC Value ⁵ (mg/kg)	Potential ARAR/TBC Source	COPC Flag	Rationale for Contaminant Deletion or Selection ⁶
VOC															
76-13-1	1,1,2-Trichloro-1,2,2-Trifluoroethane	0.0015	J	0.0015	J	WS-59-01-016-13	1 / 53	0.005 - 0.006	0.0015		5,600		NYSDEC TAGM 4046	NO	BSL
75-35-4	1,1-Dichloroethene	0.001	J	0.001	J	WS-59-01-011-1	1 / 53	0.005 - 0.006	0.001		12	0.4	NYSDEC TAGM 4046	NO	BSL
67-64-1	Acetone	0.0048	J	0.069	NJ	WS-59-01-012-2	13 / 53	0.005 - 0.025	0.069		400	0.2	NYSDEC TAGM 4046	NO	BSL
	Meta/Para Xylene	0.0022	J	0.0023	J	WS-59-01-007-13	2 / 48	0.0055 - 0.006	0.0023		27		NYSDEC TAGM 4046	NO	BSL
78-93-3	Methyl ethyl ketone	0.0026	J	0.007	J	WS-59-01-012-2	5 / 53	0.005 - 0.012	0.007		2,200			NO	BSL
75-09-2	Methylene chloride	0.0021	J	0.0021	J	FD-59-WS-03/WS-59-01-006-12	1 / 53	0.005 - 0.006	0.0021		9.1	0.1	NYSDEC TAGM 4046	NO	BSL
95-47-6	Ortho Xylene	0.001	J	0.0019	J	WS-59-01-016-10	5 / 48	0.0055 - 0.006	0.0019		27			NO	BSL
127-18-4	Tetrachloroethene	0.0053	J	0.0067	J	WS-59-01-016-20	3 / 53	0.005 - 0.006	0.0067		0.48	1.4	NYSDEC TAGM 4046	NO	BSL
1330-20-7	Total Xylenes	0.003	J	0.003	J	WS-59-01-011-1	1 / 5	0.005 - 0.006	0.003		27			NO	BSL
79-01-6	Trichloroethene	0.0011	J	0.0028	J	FD-59-WS-03/WS-59-01-006-12	4 / 53	0.005 - 0.006	0.0028		0.053	0.7	NYSDEC TAGM 4046	NO	BSL
SVOC															
92-52-4	1,1'-Biphenyl	0.059	J	0.059	J	WS-59-01-012-2	1 / 5	0.37 - 1.9	0.059		300		NYSDEC TAGM 4046	NO	BSL
91-57-6	2-Methylnaphthalene	0.039	J	1.2	J	WS-59-01-007-1	27 / 53	0.37 - 3.8	1.2		31			NO	BSL
83-32-9	Acenaphthene	0.046	J	2.4		WS-59-01-016-9	46 / 53	0.37 - 1.9	2.4		370	50	NYSDEC TAGM 4046	NO	BSL
208-96-8	Acenaphthylene	0.097	J	3.5	J	WS-59-01-007-14	52 / 53	0.37 - 0.37	3.5			41	NYSDEC TAGM 4046	NO	NSV
120-12-7	Anthracene	0.11	J	6.6		WS-59-01-007-14	53 / 53		6.6		2,200	50	NYSDEC TAGM 4046	NO	BSL
56-55-3	Benzo(a)anthracene	0.086	NJ	14		WS-59-01-011-7	53 / 53		14		0.62	0.224	NYSDEC TAGM 4046	YES	ASL
50-32-8	Benzo(a)pyrene	0.085	J	16		WS-59-01-011-7	53 / 53		16		0.062	0.061	NYSDEC TAGM 4046	YES	ASL
205-99-2	Benzo(b)fluoranthene	0.11	J	11		WS-59-01-011-7	53 / 53		11		0.62	1.1	NYSDEC TAGM 4046	YES	ASL
191-24-2	Benzo(ghi)perylene	0.052	J	8		WS-59-01-011-7	53 / 53		8			50	NYSDEC TAGM 4046	NO	NSV
207-08-9	Benzo(k)fluoranthene	0.048	J	13		WS-59-01-011-7	53 / 53		13		6.2	1.1	NYSDEC TAGM 4046	YES	ASL
117-81-7	Bis(2-Ethylhexyl)phthal	0.097	J	0.13	NJ	WS-59-01-012-2	3 / 53	0.38 - 3.8	0.13		35	50	NYSDEC TAGM 4046	NO	BSL
86-74-8	Carbazole	0.042	J	1.1	J	WS-59-01-011-1	4 / 5	0.37 - 0.37	1.1		24			NO	BSL
218-01-9	Chrysene	0.087	J	13		WS-59-01-007-14	53 / 53		13		62	0.4	NYSDEC TAGM 4046	YES	CSG
53-70-3	Dibenz(a,h)anthracene	0.073	J	2.9	J	WS-59-01-012-3	52 / 53	0.37 - 0.37	2.9		0.062	0.014	NYSDEC TAGM 4046	YES	ASL
132-64-9	Dibenzofuran	0.19	J	1.3	J	WS-59-01-016-9	33 / 53	0.37 - 3.8	1.3		15	6.2	NYSDEC TAGM 4046	NO	BSL
206-44-0	Fluoranthene	0.17	J	29		WS-59-01-007-14	53 / 53		29		230	50	NYSDEC TAGM 4046	NO	BSL
86-73-7	Fluorene	0.051	NJ	3.1		WS-59-01-016-9	47 / 53	0.37 - 1.9	3.1		270	50	NYSDEC TAGM 4046	NO	BSL
193-39-5	Indeno(1,2,3-cd)pyrene	0.055	J	8	J	WS-59-01-011-7	53 / 53		8		0.62	3.2	NYSDEC TAGM 4046	YES	ASL
91-20-3	Naphthalene	0.046	J	1.2	J	WS-59-01-007-13	33 / 53	0.37 - 3.8	1.2		5.6	13	NYSDEC TAGM 4046	NO	BSL

**TABLE G-1C
OCCURRENCE, DISTRIBUTION AND SELECTION OF CHEMICALS OF POTENTIAL CONCERN IN SEAD-59 STOCKPILE SOIL
SEAD-59 AND SEAD-71 PHASE II RI
Seneca Army Depot Activity**

Scenario Time frame:	Current/Future
Medium:	Soil
Exposure Medium:	Soil
Exposure Point:	SEAD-59 Stockpile

CAS Number	Chemical	Minimum Detected Concentration ¹ (mg/kg)	Q	Maximum Detected Concentration ¹ (mg/kg)	Q	Location of Maximum Concentration	Detection Frequency ¹	Range of Reporting Limits ¹ (mg/kg)	Concentration Used for Screening ² (mg/kg)	Background Value ³ (mg/kg)	Screening Value ⁴ (mg/kg)	ARAR /TBC Value ⁵ (mg/kg)	Potential ARAR/TBC Source	COPC Flag	Rationale for Contaminant Deletion or Selection ⁶
87-86-5	Pentachlorophenol	0.66	J	0.66	J	WS-59-01-014-5	1 / 53	0.93 - 20	0.66		3.0	1	NYSDEC TAGM 4046	NO	BSL
85-01-8	Phenanthrene	0.12	J	17		WS-59-01-007-14	53 / 53		17			50	NYSDEC TAGM 4046	NO	NSV
129-00-0	Pyrene	0.16	J	22		WS-59-01-012-3	53 / 53		22		230	50	NYSDEC TAGM 4046	NO	BSL
Pesticide															
72-54-8	4,4'-DDD	0.006		0.45		WS-59-01-015-14	33 / 53	0.019 - 0.098	0.45		2.4	2.9	NYSDEC TAGM 4046	NO	BSL
72-55-9	4,4'-DDE	0.0024	J	0.23		WS-59-01-006-9	33 / 53	0.018 - 0.098	0.23		1.7	2.1	NYSDEC TAGM 4046	NO	BSL
50-29-3	4,4'-DDT	0.0061	J	0.52		WS-59-01-015-14	37 / 53	0.019 - 0.098	0.52		1.7	2.1	NYSDEC TAGM 4046	NO	BSL
319-84-6	Alpha-BHC	0.0044		0.0044		WS-59-01-011-2	1 / 53	0.0019 - 0.051	0.0044		0.09	0.11	NYSDEC TAGM 4046	NO	BSL
5103-71-9	Alpha-Chlordane	0.0034		0.027	J	WS-59-01-011-8	6 / 53	0.002 - 0.051	0.027		1.6			NO	BSL
319-85-7	Beta-BHC	0.013	NJ	0.013	NJ	WS-59-01-014-5	1 / 53	0.0019 - 0.051	0.013		0.32	0.2	NYSDEC TAGM 4046	NO	BSL
53494-70-5	Endrin ketone	0.015	J	0.015	J	WS-59-01-011-2	1 / 53	0.0037 - 0.098	0.015		1.8			NO	BSL
58-89-9	Gamma-Chlordane	0.0079		0.021	J	WS-59-01-005-5	5 / 53	0.0019 - 0.051	0.021		1.6	0.54	NYSDEC TAGM 4046	NO	BSL
Metals															
7429-90-5	Aluminum	6,830	J	13,400		WS-59-01-005-5	53 / 53		13,400	20,500	7,600	19,300	NYSDEC TAGM 4046	YES	ASL
7440-36-0	Antimony	0.96	J	43.9	J	WS-59-01-015-14	11 / 53	1.6 - 1.8	43.9	6.55	3.1	5.9	NYSDEC TAGM 4046	YES	ASL
7440-38-2	Arsenic	3.6	J	7.3	J	WS-59-01-014-5	53 / 53		7.3	21.5	0.39	8.2	NYSDEC TAGM 4046	YES	ASL
7440-39-3	Barium	53.6		135		WS-59-01-015-14	53 / 53		135	159	540	300	NYSDEC TAGM 4046	NO	BSL
7440-41-7	Beryllium	0.14	J	0.69		WS-59-01-005-4	53 / 53		0.69	1.4	15	1.1	NYSDEC TAGM 4046	NO	BSL
7440-43-9	Cadmium	0.29	J	1.2		WS-59-01-016-5	52 / 53	0.14 - 0.14	1.2	2.9	3.7	2.3	NYSDEC TAGM 4046	NO	BSL
7440-70-2	Calcium	17,500		100,000		WS-59-01-016-20	53 / 53		100,000	293,000	2,500,000	121,000	NYSDEC TAGM 4046	NO	NUT
7440-47-3	Chromium	11.4	J	35		WS-59-01-016-18	53 / 53		35	32.7	210	29.6	NYSDEC TAGM 4046	NO	BSL
7440-48-4	Cobalt	6.1	J	13.9		WS-59-01-006-9	53 / 53		13.9	29.1	900	30	NYSDEC TAGM 4046	NO	BSL
7440-50-8	Copper	18.4	J	51.8	J	WS-59-01-016-18	53 / 53		51.8	62.8	310	33	NYSDEC TAGM 4046	NO	BSL
7439-89-6	Iron	14,900		26,500		WS-59-01-008-2	53 / 53		26,500	38,600	2,300	36,500	NYSDEC TAGM 4046	YES	ASL
7439-92-1	Lead	15.4	J	1,440	J	WS-59-01-016-10	53 / 53		1,440	266	400	24.8	NYSDEC TAGM 4046	YES	ASL
7439-95-4	Magnesium	4,890		26,600	J	WS-59-01-008-3	53 / 53		26,600	29,100	400,000	21,500	NYSDEC TAGM 4046	NO	NUT
7439-96-5	Manganese	321	J	1,220		WS-59-01-016-5	53 / 53		1,220	2,380	180	1,060	NYSDEC TAGM 4046	YES	ASL
7439-97-6	Mercury	0.04		0.52	J	WS-59-04-010-8	53 / 53		0.52	0.13	2.3	0.1	NYSDEC TAGM 4046	NO	BSL
7440-02-0	Nickel	19.1	J	56.6		WS-59-01-007-12	53 / 53		56.6	62.3	160	49	NYSDEC TAGM 4046	NO	BSL
7440-09-7	Potassium	781		1,580	J	WS-59-01-011-1	53 / 53		1,580	3,160	5,000,000	2,380	NYSDEC TAGM 4046	NO	NUT
7782-49-2	Selenium	0.69	J	0.72	J	WS-59-01-013-2	2 / 53	0.135 - 0.6	0.72	1.7	39	2	NYSDEC TAGM 4046	NO	BSL
7440-22-4	Silver	0.56		4.7		WS-59-01-016-18	9 / 53	0.055 - 0.305	4.7	0.87	39	0.75	NYSDEC TAGM 4046	NO	BSL
7440-23-5	Sodium	68.5		525		WS-59-01-016-4	53 / 53		525	269	1,125,000	172	NYSDEC TAGM 4046	NO	NUT
7440-28-0	Thallium	0.56	J	0.99	J	WS-59-01-015-16	27 / 53	0.095 - 0.295	0.99	1.2	0.52	0.7	NYSDEC TAGM 4046	YES	ASL

**TABLE G-1C
OCCURRENCE, DISTRIBUTION AND SELECTION OF CHEMICALS OF POTENTIAL CONCERN IN SEAD-59 STOCKPILE SOIL
SEAD-59 AND SEAD-71 PHASE II RI
Seneca Army Depot Activity**

Scenario Time frame:	Current/Future
Medium:	Soil
Exposure Medium:	Soil
Exposure Point:	SEAD-59 Stockpile

CAS Number	Chemical	Minimum Detected Concentration ¹ (mg/kg)	Q	Maximum Detected Concentration ¹ (mg/kg)	Q	Location of Maximum Concentration	Detection Frequency ¹	Range of Reporting Limits ¹ (mg/kg)	Concentration Used for Screening ² (mg/kg)	Background Value ³ (mg/kg)	Screening Value ⁴ (mg/kg)	ARAR /TBC Value ⁵ (mg/kg)	Potential ARAR/TBC Source	COPC Flag	Rationale for Contaminant Deletion or Selection ⁶
7440-62-2	Vanadium	13.4		35.4		WS-59-01-007-10	53 / 53		35.4	32.7	7.8	150	NYSDEC TAGM 4046	YES	ASL
7440-66-6	Zinc	57	J	185	J	WS-59-01-006-9	53 / 53		185	126	2,300	110	NYSDEC TAGM 4046	NO	BSL

Notes:

- Field duplicates were averaged and regarded as one sample entry. Laboratory duplicates were not included in the assessment. Range of reporting limits were presented for nondetects only.
- The maximum detected concentration was used for screening.
- Background value is the maximum Seneca background concentration.
- EPA Region 9 Preliminary Remediation Goals (PRGs) for residential soil. On-line resources available at <http://www.epa.gov/region09/waste/sfund/prg/files/prgtable2004.xls>. Last updated October 2004. Region 9 PRGs were derived based on Direct contact exposure (ingestion and dermal contact) and a target Cancer Risk of 1E-6 or a Target Hazard Quotient of 1. EPA Region III Risk Based Concentration (RBC) for residential soil was used as screening value for 2-methylnaphthalene as no Region 9 PRG is available. EPA Region III RBC, available on-line at <http://www.epa.gov/reg3hwmd/risk/human/rbc/rbc1004.XLS>, was calculated based on soil ingestion exposure and a target cancer risk of 1E-6 and a target hazard quotient of 1. The PRGs or RBCs corresponding to a hazard quotient of 1 were adjusted by multiplying 0.1 before they were used as screening values. PRG for gamma-chlordane was used as screening value for alpha-chlordane. PRG for endrin was used as screening value for endrin ketone. Screening values for calcium, magnesium, potassium, and sodium were calculated based on 200 mg/day soil ingestion and recommended dietary allowances and adequate intakes for 1-3 yr children (500 mg/day and 80 mg/day for calcium and magnesium) and minimum requirements for 1 yr children (225 mg/day and 1000 mg/day for sodium and potassium) from Marilyn Wright (2001) Dietary Reference Intakes. PRG for total chromium (1:6 ratio Cr VI: Cr III) was used as screening value for chromium. PRG for nickel (soluble salts) was used as screening value for nickel.
- Potential ARAR/TBC values are from NYSDEC Technical and Administrative Guidance Memorandum #4046 (on-line resources available at <http://www.dec.state.ny.us/website/der/tagms/prtg4046.html>)
- Rationale codes

Selection Reason:	Above Screening Levels (ASL)
	Chemicals in the Same Group were retained as COPC (CSG)
Deletion Reason:	Essential Nutrient (NUT)
	Below Screening Level (BSL)
	No Screening Value or Toxicity Value (NSV)

Definitions:

- COPC = Chemical of Potential Concern
 ARAR/TBC = Applicable or Relevant and Appropriate Requirement/To Be Considered
 Q = Qualifier
 J = Estimated Value
 NJ = Presence of the analyte has been "tentatively identified" and the associated numerical value represents its approximate concentration.

TABLE G-1D
OCCURRENCE, DISTRIBUTION AND SELECTION OF CHEMICALS OF POTENTIAL CONCERN IN SEAD-71 SOIL (FENCED AREA EXCLUDED)
SEAD-59 AND SEAD-71 PHASE II RI
Seneca Army Depot Activity

Scenario Timeframe:	Current/Future
Medium:	Soil
Exposure Medium:	Soil
Exposure Point:	SEAD-71

CAS Number	Chemical	Minimum Detected Concentration ¹ (mg/kg)	Q	Maximum Detected Concentration ¹ (mg/kg)	Q	Location of Maximum Concentration	Detection Frequency ¹	Range of Reporting Limits ¹ (mg/kg)	Concentration Used for Screening ² (mg/kg)	Background Value ³ (mg/kg)	Screening Value ⁴ (mg/kg)	ARAR/TBC Value ⁵ (mg/kg)	Potential ARAR/TBC Source	COPC Flag	Rationale for Contaminant Deletion or Selection ⁶
VOC															
71-55-6	1,1,1-Trichloroethane	0.002	NJ	0.023		TP71-1	6 / 61	0.005 - 0.11	0.023		1,200	0.8	NYSDEC TAGM 4046	NO	BSL
67-64-1	Acetone	0.004	NJ	0.074		SS71-14	9 / 61	0.005 - 0.11	0.074		1,400	0.2	NYSDEC TAGM 4046	NO	BSL
71-43-2	Benzene	0.001	J	0.002	J	SS71-1	2 / 61	0.005 - 0.11	0.002		0.64	0.06	NYSDEC TAGM 4046	NO	BSL
75-15-0	Carbon disulfide	0.002	J	0.005	J	CL-71-B-WN1	3 / 61	0.005 - 0.11	0.005		36	2.7	NYSDEC TAGM 4046	NO	BSL
110-82-7	Cyclohexane	0.003	J	0.004	J	WS-71-A-009-9	2 / 23	0.005 - 0.006	0.004		14			NO	BSL
108-87-2	Methyl cyclohexane	0.003	J	0.006		WS-71-A-009-9	3 / 23	0.005 - 0.006	0.006		260			NO	BSL
75-09-2	Methylene chloride	0.001	J	0.002	J	SS71-1	8 / 61	0.005 - 0.11	0.002		9.1	0.1	NYSDEC TAGM 4046	NO	BSL
127-18-4	Tetrachloroethene	0.001	J	0.003	J	TP71-1	3 / 61	0.005 - 0.11	0.003		0.48	1.4	NYSDEC TAGM 4046	NO	BSL
108-88-3	Toluene	0.001	J	0.004	J	SS71-1	4 / 61	0.005 - 0.11	0.004		520	1.5	NYSDEC TAGM 4046	NO	BSL
	Total BTEX	3.05		11.6		TP71-3-1	4 / 4		11.6					NO	ICE
1330-20-7	Total Xylenes	0.002	J	0.096	J	TP71-3-2	4 / 37	0.005 - 0.015	0.096		27	1.2	NYSDEC TAGM 4046	NO	BSL
75-69-4	Trichlorofluoromethane	0.001	J	0.001	J	WS-71-B-009-6	1 / 23	0.005 - 0.006	0.001		39			NO	BSL
SVOC															
121-14-2	2,4-Dinitrotoluene	0.88	J	0.88	J	WS-71-D-009-13	1 / 62	0.066 - 19	0.88		12			NO	BSL
91-57-6	2-Methylnaphthalene	0.0086	J	31	J	TP71-3-2	12 / 62	0.078 - 19	31		31	36.4	NYSDEC TAGM 4046	YES	ASL
100-01-6	4-Nitroaniline	0.075	J	0.075	J	WS-71-B-009-6	1 / 40	0.16 - 45	0.075		23			NO	BSL
83-32-9	Acenaphthene	0.0055	J	13	J	TP71-3-2	23 / 62	0.078 - 5.5	13		370	50	NYSDEC TAGM 4046	NO	BSL
208-96-8	Acenaphthylene	0.02	J	1.8		CL-71-C-WN1	20 / 62	0.066 - 19	1.8			41	NYSDEC TAGM 4046	NO	NSV
120-12-7	Anthracene	0.012	J	11	J	TP71-1	35 / 62	0.078 - 5.5	11		2,200	50	NYSDEC TAGM 4046	NO	BSL
56-55-3	Benzo(a)anthracene	0.0039	J	37		TP71-1	46 / 62	0.078 - 1.9	37		0.62	0.224	NYSDEC TAGM 4046	YES	ASL
50-32-8	Benzo(a)pyrene	0.0039	J	22		TP71-1	46 / 62	0.066 - 1.9	22		0.062	0.061	NYSDEC TAGM 4046	YES	ASL
205-99-2	Benzo(b)fluoranthene	0.0044	J	26		TP71-1	47 / 62	0.066 - 1.9	26		0.62	1.1	NYSDEC TAGM 4046	YES	ASL
191-24-2	Benzo(ghi)perylene	0.012	J	10	J	TP71-1	40 / 62	0.066 - 1.9	10			50	NYSDEC TAGM 4046	NO	NSV
207-08-9	Benzo(k)fluoranthene	0.0046	J	15	J	TP71-1	36 / 62	0.066 - 1.9	15		6.2	1.1	NYSDEC TAGM 4046	YES	ASL
117-81-7	Bis(2-Ethylhexyl)phthalate	0.0076	J	0.14	J	WS-71-D-009-13	9 / 62	0.066 - 19	0.14		35	50	NYSDEC TAGM 4046	NO	BSL
86-74-8	Carbazole	0.0042	J	9.5	J	TP71-1	22 / 40	0.078 - 1.1	9.5		24			NO	BSL
218-01-9	Chrysene	0.0046	J	36		TP71-1	49 / 62	0.078 - 1.9	36		62	0.4	NYSDEC TAGM 4046	YES	CSG
84-74-2	Di-n-butylphthalate	0.0064	J	0.07	J	CL-71-C-WE2	3 / 62	0.066 - 19	0.07		610	8.1	NYSDEC TAGM 4046	NO	BSL
53-70-3	Dibenz(a,h)anthracene	0.0044	J	9.8	J	TP71-1	32 / 62	0.066 - 5.5	9.8		0.062	0.014	NYSDEC TAGM 4046	YES	ASL
132-64-9	Dibenzofuran	0.013	J	11	J	TP71-3-2	18 / 62	0.078 - 19	11		15	6.2	NYSDEC TAGM 4046	NO	BSL
206-44-0	Fluoranthene	0.0069	J	88		TP71-1	50 / 62	0.078 - 0.4	88		230	50	NYSDEC TAGM 4046	NO	BSL
86-73-7	Fluorene	0.0047	J	4.1		TP71-3-2	21 / 62	0.078 - 5.5	4.1		270	50	NYSDEC TAGM 4046	NO	BSL
193-39-5	Indeno(1,2,3-cd)pyrene	0.012	J	12	J	TP71-1	40 / 62	0.066 - 1.9	12		0.62	3.2	NYSDEC TAGM 4046	YES	ASL

TABLE G-1D
OCCURRENCE, DISTRIBUTION AND SELECTION OF CHEMICALS OF POTENTIAL CONCERN IN SEAD-71 SOIL (FENCED AREA EXCLUDED)
SEAD-59 AND SEAD-71 PHASE II RI
Seneca Army Depot Activity

Scenario Timeframe:	Current/Future
Medium:	Soil
Exposure Medium:	Soil
Exposure Point:	SEAD-71

CAS Number	Chemical	Minimum Detected Concentration ¹ (mg/kg)	Q	Maximum Detected Concentration ¹ (mg/kg)	Q	Location of Maximum Concentration	Detection Frequency ¹	Range of Reporting Limits ¹ (mg/kg)	Concentration Used for Screening ² (mg/kg)	Background Value ³ (mg/kg)	Screening Value ⁴ (mg/kg)	ARAR/TBC Value ⁵ (mg/kg)	Potential ARAR/TBC Source	COPC Flag	Rationale for Contaminant Deletion or Selection ⁶
91-20-3	Naphthalene	0.01	J	17	J	TP71-3-2	13 / 62	0.078 - 19	17		5.6	13	NYSDEC TAGM 4046	YES	ASL
85-01-8	Phenanthrene	0.024	J	66	J	TP71-1	45 / 62	0.078 - 1.9	66			50	NYSDEC TAGM 4046	NO	NSV
108-95-2	Phenol	0.0045	J	0.0045	J	TP71-3-1	1 / 62	0.078 - 19	0.0045		1,800	0.03	NYSDEC TAGM 4046	NO	BSL
129-00-0	Pyrene	0.006	J	63	J	TP71-1	48 / 62	0.078 - 1.9	63		230	50	NYSDEC TAGM 4046	NO	BSL
Pesticide															
72-54-8	4,4'-DDD	0.0028	J	0.017	J	CL-71-B-WE2	9 / 62	0.0035 - 0.04	0.017		2.4	2.9	NYSDEC TAGM 4046	NO	BSL
72-55-9	4,4'-DDE	0.0031	J	0.19	J	CL-71-B-WS1	22 / 62	0.0034 - 0.038	0.19		1.7	2.1	NYSDEC TAGM 4046	NO	BSL
50-29-3	4,4'-DDT	0.0051	J	0.12	J	CL-71-E2-WW1	28 / 62	0.0034 - 0.038	0.12		1.7	2.1	NYSDEC TAGM 4046	NO	BSL
319-84-6	Alpha-BHC	0.0019	J	0.018	J	TP71-6-1	5 / 62	0.0018 - 0.021	0.018		0.09	0.11	NYSDEC TAGM 4046	NO	BSL
5103-71-9	Alpha-Chlordane	0.074	J	0.074	J	TP71-1	1 / 62	0.0018 - 0.021	0.074		1.6			NO	BSL
319-85-7	Beta-BHC	0.002	J	0.0027	J	TP71-6-1	2 / 62	0.0018 - 0.021	0.0027		0.32	0.2	NYSDEC TAGM 4046	NO	BSL
319-86-8	Delta-BHC	0.0018	J	0.0018	J	TP71-6-1	1 / 62	0.0018 - 0.021	0.0018		0.09	0.3	NYSDEC TAGM 4046	NO	BSL
60-57-1	Dieldrin	0.003	J	0.0035	J	TP71-1	3 / 62	0.0034 - 0.04	0.0035		0.03	0.044	NYSDEC TAGM 4046	NO	BSL
959-98-8	Endosulfan I	0.0028	J	0.2	J	TP71-1	4 / 62	0.0018 - 0.021	0.2		37	0.9	NYSDEC TAGM 4046	NO	BSL
33213-65-9	Endosulfan II	0.0025	J	0.026	J	TP71-1	2 / 62	0.0034 - 0.04	0.026		37	0.9	NYSDEC TAGM 4046	NO	BSL
1031-07-8	Endosulfan sulfate	0.0027	J	0.0046	J	SS71-8	4 / 62	0.0034 - 0.04	0.0046		37	1	NYSDEC TAGM 4046	NO	BSL
72-20-8	Endrin	0.0024	J	0.029	J	TP71-1	5 / 62	0.0034 - 0.04	0.029		1.8	0.1	NYSDEC TAGM 4046	NO	BSL
7421-93-4	Endrin aldehyde	0.003	J	0.0091	J	SS71-10	9 / 62	0.0034 - 0.04	0.0091		1.8			NO	BSL
53494-70-5	Endrin ketone	0.0022	J	0.017	J	SS71-10	7 / 62	0.0034 - 0.04	0.017		1.8			NO	BSL
58-89-9	Gamma-BHC/Lindane	0.004	J	0.004	J	TP71-6-1	1 / 62	0.0018 - 0.021	0.004		0.44	0.06	NYSDEC TAGM 4046	NO	BSL
5103-74-2	Gamma-Chlordane	0.0011	J	0.0012	J	SS71-1	2 / 62	0.0018 - 0.021	0.0012		1.6	0.54	NYSDEC TAGM 4046	NO	BSL
76-44-8	Heptachlor	0.0012	J	0.0012	J	TP71-1	1 / 62	0.0018 - 0.021	0.0012		0.11	0.1	NYSDEC TAGM 4046	NO	BSL
1024-57-3	Heptachlor epoxide	0.0015	J	0.0064	J	SS71-2	5 / 62	0.0018 - 0.021	0.0064		0.053	0.02	NYSDEC TAGM 4046	NO	BSL
72-43-5	Methoxychlor	0.019	J	0.062	J	SS71-8	3 / 62	0.018 - 0.21	0.062		31			NO	BSL
PCB															
11096-82-5	Aroclor-1260	0.08	J	0.2	J	CL-71-B-WE2	3 / 62	0.035 - 0.37	0.2		0.22	10	NYSDEC TAGM 4046	NO	BSL
Metals															
7429-90-5	Aluminum	6,120	J	15,900	J	SS71-9	62 / 62		15,900	20,500	7,600	19,300	NYSDEC TAGM 4046	YES	ASL
7440-36-0	Antimony	0.19	J	11.5	J	CL-71-B-WE2	29 / 62	0.23 - 3.6	11.5	6.55	3.1	5.9	NYSDEC TAGM 4046	YES	ASL
7440-38-2	Arsenic	3.1	J	14.6	J	SS71-9	62 / 62		14.6	21.5	0.39	8.2	NYSDEC TAGM 4046	YES	ASL
7440-39-3	Barium	47	J	136	J	CL-71-E1-WN1	62 / 62		136	159	540	300	NYSDEC TAGM 4046	NO	BSL
7440-41-7	Beryllium	0.11	J	0.85	J	CL-71-E1-WN1	62 / 62		0.85	1.4	15	1.1	NYSDEC TAGM 4046	NO	BSL
7440-43-9	Cadmium	0.17	J	0.71	J	CL-71-E3-WS1	40 / 62	0.07 - 0.3	0.71	2.9	3.7	2.3	NYSDEC TAGM 4046	NO	BSL
7440-70-2	Calcium	6,040	J	295,000	J	SS71-14	62 / 62		295,000	293,000	2,500,000	121,000	NYSDEC TAGM 4046	NO	NUT

**TABLE G-1D
OCCURRENCE, DISTRIBUTION AND SELECTION OF CHEMICALS OF POTENTIAL CONCERN IN SEAD-71 SOIL (FENCED AREA EXCLUDED)
SEAD-59 AND SEAD-71 PHASE II RI
Seneca Army Depot Activity**

Scenario Timeframe:	Current/Future
Medium:	Soil
Exposure Medium:	Soil
Exposure Point:	SEAD-71

CAS Number	Chemical	Minimum Detected Concentration ¹ (mg/kg)	Q	Maximum Detected Concentration ¹ (mg/kg)	Q	Location of Maximum Concentration	Detection Frequency ¹	Range of Reporting Limits ¹ (mg/kg)	Concentration Used for Screening ² (mg/kg)	Background Value ³ (mg/kg)	Screening Value ⁴ (mg/kg)	ARAR/TBC Value ⁵ (mg/kg)	Potential ARAR/TBC Source	COPC Flag	Rationale for Contaminant Deletion or Selection ⁶
7440-47-3	Chromium	10	J	37.1		CL-71-C-WN1	62 / 62		37.1	32.7	210	29.6	NYSDEC TAGM 4046	NO	BSL
7440-48-4	Cobalt	6.1	J	13.9		CL-71-E3-WS1	62 / 62		13.9	29.1	900	30	NYSDEC TAGM 4046	NO	BSL
7440-50-8	Copper	15.2		102		WS-71-E1-009-3	62 / 62		102	62.8	310	33	NYSDEC TAGM 4046	NO	BSL
7439-89-6	Iron	13,200		38,000		SS71-9	62 / 62		38,000	38,600	2,300	36,500	NYSDEC TAGM 4046	YES	ASL
7439-92-1	Lead	7.3		1,010		WS-71-D-009-13	62 / 62		1,010	266	400	24.8	NYSDEC TAGM 4046	YES	ASL
7439-95-4	Magnesium	3,800		59,300		SS71-14	62 / 62		59,300	29,100	400,000	21,500	NYSDEC TAGM 4046	NO	NUT
7439-96-5	Manganese	296		1,330		CL-71-E3-WS1	62 / 62		1,330	2,380	180	1,060	NYSDEC TAGM 4046	YES	ASL
7439-97-6	Mercury	0.02	J	1	J	CL-71-B-WS1	52 / 62	0.05 - 0.07	1	0.13	2.3	0.1	NYSDEC TAGM 4046	NO	BSL
7440-02-0	Nickel	18	J	110		SS71-10	62 / 62		110	62.3	160	49	NYSDEC TAGM 4046	NO	BSL
7440-09-7	Potassium	810	J	2,940		TP71-4-2	62 / 62		2,940	3,160	5,000,000	2,380	NYSDEC TAGM 4046	NO	NUT
7782-49-2	Selenium	0.43	J	1.8	J	SS71-10	8 / 62	0.37 - 1.1	1.8	1.7	39	2	NYSDEC TAGM 4046	NO	BSL
7440-22-4	Silver	0.32	J	1.8		CL-71-E1-WN1	22 / 62	0.07 - 0.67	1.8	0.87	39	0.75	NYSDEC TAGM 4046	NO	BSL
7440-23-5	Sodium	33.2	J	636		SS71-10	59 / 62	83.3 - 108	636	269	1,125,000	172	NYSDEC TAGM 4046	NO	NUT
7440-28-0	Thallium	0.57	J	2.3		SS71-9	18 / 62	0.19 - 1.7	2.3	1.2	0.52	0.7	NYSDEC TAGM 4046	YES	ASL
7440-62-2	Vanadium	11.3	J	24.9		TP71-4-2	62 / 62		24.9	32.7	7.8	150	NYSDEC TAGM 4046	YES	ASL
7440-66-6	Zinc	45.3		1,740	J	SS71-10	61 / 62	352 - 352	1,740	126	2,300	110	NYSDEC TAGM 4046	NO	BSL

Notes:

- Field duplicates were averaged and regarded as one sample entry. Laboratory duplicates were not included in the assessment. Range of reporting limits were presented for nondetects only.
- The maximum detected concentration was used for screening.
- Background value is the maximum Seneca background concentration.
- EPA Region 9 Preliminary Remediation Goals (PRGs) for residential soil. On-line resources available at <http://www.epa.gov/region09/waste/sfund/prg/files/prgtable2004.xls>. Last updated October 2004. Region 9 PRGs were derived based on Direct contact exposure (ingestion and dermal contact) and a target Cancer Risk of 1E-6 or a Target Hazard Quotient of 1. EPA Region III Risk Based Concentration (RBC) for residential soil was used as screening value for 2-methylnaphthalene as no Region 9 PRG is available. EPA Region III RBC, available on-line at <http://www.epa.gov/reg3hwmd/risk/human/rbc/rbc1004.XLS>, was calculated based on soil ingestion exposure and a target cancer risk of 1E-6 and a target hazard quotient of 1. The PRGs or RBCs corresponding to a hazard quotient of 1 were adjusted by multiplying 0.1 before they were used as screening values. PRG for Aroclor 1254 was used as screening value for Aroclor 1260. PRG for gamma-chlordane was used as screening value for alpha-chlordane. PRG for alpha-BHC was used as screening value for delta-BHC. PRG for endosulfan was used as screening value for endosulfan I, endosulfan II, and endosulfan sulfate. PRG for endrin was used as screening value for endrin aldehyde and endrin ketone. Screening values for calcium, magnesium, potassium, and sodium were calculated based on 200 mg/day soil ingestion and recommended dietary allowances and adequate intakes for 1-3 yr children (500 mg/day and 80 mg/day for calcium and magnesium) and minimum requirements for 1 yr children (225 mg/day and 1000 mg/day for sodium and potassium) from Marilyn Wright (2001) Dietary Reference Intakes. PRG for total chromium (1:6 ratio Cr VI: Cr III) was used as screening value for chromium. PRG for nickel (soluble salts) was used as screening value for nickel.

**TABLE G-1D
OCCURRENCE, DISTRIBUTION AND SELECTION OF CHEMICALS OF POTENTIAL CONCERN IN SEAD-71 SOIL (FENCED AREA EXCLUDED)
SEAD-59 AND SEAD-71 PHASE II RI
Seneca Army Depot Activity**

Scenario Timeframe:	Current/Future
Medium:	Soil
Exposure Medium:	Soil
Exposure Point:	SEAD-71

CAS Number	Chemical	Minimum Detected Concentration ¹ (mg/kg)	Q	Maximum Detected Concentration ¹ (mg/kg)	Q	Location of Maximum Concentration	Detection Frequency ¹	Range of Reporting Limits ¹ (mg/kg)	Concentration Used for Screening ² (mg/kg)	Background Value ³ (mg/kg)	Screening Value ⁴ (mg/kg)	ARAR/TBC Value ⁵ (mg/kg)	Potential ARAR/TBC Source	COPC Flag	Rationale for Contaminant Deletion or Selection ⁶
------------	----------	--	---	--	---	-----------------------------------	----------------------------------	---	--	--	---	--	---------------------------	-----------	--

5. Potential ARAR/TBC values are from NYSDEC Technical and Administrative Guidance Memorandum #4046 (on-line resources available at <http://www.dec.state.ny.us/website/der/tagms/prtg4046.html>)

6. Rationale codes
 Selection Reason: Above Screening Levels (ASL)
 Deletion Reason: Essential Nutrient (NUT)
 Below Screening Level (BSL)
 Individual Chemicals Evaluated (ICE)
 No Screening Value or Toxicity Value (NSV)

Definitions:
 COPC = Chemical of Potential Concern
 ARAR/TBC = Applicable or Relevant and Appropriate Requirement/To Be Considered
 Q = Qualifier
 J = Estimated Value
 NJ = Presence of the analyte has been "tentatively identified" and the associated numerical value represents its approximate concentration.

TABLE G-1E
OCCURRENCE, DISTRIBUTION AND SELECTION OF CHEMICALS OF POTENTIAL CONCERN IN SEAD-71 GROUNDWATER (FENCED AREA EXCLUDED)
SEAD-59 AND SEAD-71 PHASE II RI
SENECA ARMY DEPOT ACTIVITY

Scenario Timeframe:	Current/Future
Medium:	Groundwater
Exposure Medium:	Groundwater
Exposure Point:	Aquifer -- Tap Water

CAS #	Chemical	Minimum Detected Concentration ¹ (ug/L)	Q	Maximum Detected Concentration ¹ (ug/L)	Q	Location of Maximum Concentration	Detection Frequency ¹	Range of Reporting Limits ¹ (ug/L)	Concentration Used for Screening ² (ug/L)	Background Value ³ (ug/L)	Screening Value ⁴ (ug/L)	Potential ARAR /TBC Value (ug/L)	ARAR/ TBC Source	COPC Flag	Rationale for COPC Deletion or Selection ⁵
VOC															
71-55-6	1,1,1-Trichloroethane	2.5		3.1		MW71-4	2 / 8	0.5 - 10	3.1		320	5	GA	NO	BSL
SVOC															
100-01-6	4-Nitroaniline	8.7	J	8.7	J	MW71-2	1 / 8	9.6 - 32	8.7		3.2	5	GA	YES	ASL
117-81-7	Bis(2-Ethylhexyl)phthalate	1.6	J	1.6	J	MW71-3	1 / 8	9.6 - 16	1.6		4.8	5	GA	NO	BSL
Pesticides															
72-55-9	4,4'-DDE	0.006	J	0.013	J	MW71-4	2 / 6	0.0388 - 0.0408	0.013		0.20	0.2	GA	NO	BSL
50-29-3	4,4'-DDT	0.030	J	0.0437		MW71-4	3 / 6	0.0388 - 0.04	0.0437		0.20	0.2	GA	NO	BSL
53494-70-5	Endrin ketone	0.008	J	0.008	J	MW71-3	1 / 6	0.0375 - 0.0408	0.008		1.1	5	GA	NO	BSL
Metals															
7429-90-5	Aluminum	51.2	J	19,700		MW71-1	5 / 8	14.7 - 100	19,700	2,730	3,600	50	SEC	YES	ASL
7440-36-0	Antimony	6.28	J	6.52	J	MW71-1	2 / 8	1 - 10	6.52	8.2	1.5	3	GA	YES	ASL
7440-38-2	Arsenic	2.7	J	2.7	J	MW71-1	1 / 8	2 - 22.4	2.7	1.7	0.045	10	MCL	YES	ASL
7440-39-3	Barium	37.1		164	J	MW71-1	8 / 8		164	78.2	260	1,000	GA	NO	BSL
7440-41-7	Beryllium	0.819		0.88	J	MW71-1	2 / 8	0.1 - 5	0.88	0.21	7.3	4	MCL	NO	BSL
7440-43-9	Cadmium	0.33	J	0.33	J	MW71-1	1 / 8	0.2 - 5	0.33	0.5	1.8	5	GA	NO	BSL
7440-70-2	Calcium	97,800		218,000		MW71-1	8 / 8		218,000	116,000	250,000			NO	NUT
7440-47-3	Chromium	0.59	J	33.1		MW71-1	4 / 8	0.503 - 5	33.1	4.7	11	50	GA	YES	ASL
7440-48-4	Cobalt	0.631	J	22.1	J	MW71-1	4 / 8	0.541 - 5	22.1	3.7	73			NO	BSL
7440-50-8	Copper	0.75	J	16.1	J	MW71-1	4 / 8	1.39 - 5	16.1	3.3	150	200	GA	NO	BSL
7439-89-6	Iron	22.9	J	35,100		MW71-1	8 / 8		35,100	4,480	1,100	300	GA	YES	ASL
7439-92-1	Lead	2.1	J	17.2		MW71-1	3 / 8	0.89 - 5	17.2	2.5	15	15	MCL	YES	ASL
7439-95-4	Magnesium	12,500		32,400		MW71-1	8 / 8		32,400	28,600	40,000			NO	NUT
7439-96-5	Manganese	8.1		2,680		MW71-2	7 / 8	0.296 - 0.296	2,680	224	88	50	SEC	YES	ASL
7439-97-6	Mercury	0.05	J	0.069	J	MW71-3	3 / 8	0.047 - 0.2	0.069	0.04	1.1	0.7	GA	NO	BSL
7440-02-0	Nickel	0.74	J	49.4		MW71-1	6 / 8	0.69 - 0.69	49.4	7.3	73	100	GA	NO	BSL
9/7/7440	Potassium	765	J	4,910	J	MW71-3	8 / 8		4,910	3,830	700,000			NO	NUT
7440-23-5	Sodium	4,130	J	62,200		MW71-3	8 / 8		62,200	14,600	1,200,000	20,000	GA	NO	NUT
7440-28-0	Thallium	2.5	J	2.5	J	MW71-3	1 / 8	1.6 - 20	2.5	1.5	0.24	2	MCL	YES	ASL
7440-62-2	Vanadium	0.9	J	25.7	J	MW71-1	3 / 8	0.606 - 5	25.7	5.2	3.6			YES	ASL
7440-66-6	Zinc	1.6	J	97.3		MW71-1	8 / 8		97.3	23.1	1,100	5,000	SEC	NO	BSL

TABLE G-1E
OCCURRENCE, DISTRIBUTION AND SELECTION OF CHEMICALS OF POTENTIAL CONCERN IN SEAD-71 GROUNDWATER (FENCED AREA EXCLUDED)
SEAD-59 AND SEAD-71 PHASE II RI
SENECA ARMY DEPOT ACTIVITY

Scenario Timeframe:	Current/Future
Medium:	Groundwater
Exposure Medium:	Groundwater
Exposure Point:	Aquifer -- Tap Water

CAS #	Chemical	Minimum Detected Concentration ¹ Q (ug/L)	Maximum Detected Concentration ¹ Q (ug/L)	Location of Maximum Concentration	Detection Frequency ¹	Range of Reporting Limits ¹ (ug/L)	Concentration Used for Screening ² (ug/L)	Background Value ³ (ug/L)	Screening Value ⁴ (ug/L)	Potential ARAR /TBC Value (ug/L)	ARAR/TBC Source	COPC Flag	Rationale for COPC Deletion or Selection ⁵
-------	----------	--	--	-----------------------------------	----------------------------------	---	--	--------------------------------------	-------------------------------------	----------------------------------	-----------------	-----------	---

Notes:

- Field duplicates were averaged and regarded as one sample entry. Laboratory duplicates were not included in the assessment. Range of reporting limits were presented for nondetects only.
- The maximum detected concentration was used for screening.
- Background values are average concentrations of background sample results.
- EPA Region 9 Preliminary Remediation Goals (PRGs) for tap water. On-line resources available at <http://www.epa.gov/region09/waste/sfund/prg/files/prgtable2004.xls>. Last updated October 2004.
 Region 9 PRGs were derived based on ingestion and inhalation exposure and a target Cancer Risk of 1E-6 or a Target Hazard Quotient of 1. The PRGs corresponding to a hazard quotient of 1 was adjusted by multiplying 0.1 before they were used as screening values.
 MCL for lead was used as screening value for lead as no Region 9 PRG is available.
 PRG for endrin was used as screening value for endrin ketone.
 Screening values for calcium, magnesium, potassium, and sodium were calculated based on an assumption of 2L/day water intake and recommended dietary allowances and adequate intakes for 1-3 yr children (500 mg/day and 80 mg/day for calcium and magnesium) and minimum requirements for 2-5 yr children (1400 mg/day for potassium) from Marilyn Wright (2001) Dietary Reference Intakes.
 For sodium, an upper limit intake of 2,400 mg/day (<http://www.mealformation.com/dailyval.html>) was used.
 PRG for chromium (VI) was used as screening value for chromium.
- Rationale codes
 Selection Reason: Above Screening Levels (ASL)
 Deletion Reason: Essential Nutrient (NUT)
 Below Screening Level (BSL)

Definitions:

COPC = Chemical of Potential Concern
 ARAR/TBC = Applicable or Relevant and Appropriate Requirement/To Be Considered
 MCL = Federal Maximum Contaminant Level
 GA = New York State Class GA Groundwater Standard (TOGS 1.1.1, June 1998 with updates)
 SEC = USEPA Secondary Drinking Water Regulation, non-enforceable (EPA 822-B-00-001, Summer 2000)
 Q = Qualifier
 J = Estimated Value

TABLE G-2A
SOIL EXPOSURE POINT CONCENTRATION SUMMARY - SURFACE SOIL FOR SEAD-59
SEAD-59 AND SEAD-71 PHASE II RI
SENECA ARMY DEPOT ACTIVITY

Scenario Timeframe:	Current/Future
Medium:	Soil
Exposure Medium:	Soil
Exposure Point:	SEAD-59

Chemical of Potential Concern	Units	Arithmetic Mean (1)	95% UCL of Normal Data (1)	Maximum Detected Concentration (1)	Q	EPC Units	Reasonable Maximum Exposure (2)			Central Tendency (2)		
							Medium EPC Value	Medium EPC Statistic	Medium EPC Rationale	Medium EPC Value	Medium EPC Statistic	Medium EPC Rationale
Surface Soil												
Benzo(a)anthracene	mg/kg	0.8	1.0	8.9	J	mg/kg	1.4	97.5 Chebyshev	Non-parametric, MH	1.4	97.5 Chebyshev	Non-parametric, MH
Benzo(a)pyrene	mg/kg	0.9	1.0	8.1	J	mg/kg	1.4	97.5 Chebyshev	Non-parametric, MH	1.4	97.5 Chebyshev	Non-parametric, MH
Benzo(b)fluoranthene	mg/kg	0.8	0.9	6.8	J	mg/kg	1.3	97.5 Chebyshev	Non-parametric, MH	1.3	97.5 Chebyshev	Non-parametric, MH
Benzo(k)fluoranthene	mg/kg	0.7	0.8	7.4	J	mg/kg	1.1	97.5 Chebyshev	Non-parametric, MH	1.1	97.5 Chebyshev	Non-parametric, MH
Chrysene	mg/kg	0.8	1.0	8.9	J	mg/kg	1.4	97.5 Chebyshev	Non-parametric, MH	1.4	97.5 Chebyshev	Non-parametric, MH
Dibenz(a,h)anthracene	mg/kg	0.3	0.3	1.7	J	mg/kg	0.35	95% Chebyshev	Non-parametric, MO	0.35	95% Chebyshev	Non-parametric, MO
Indeno(1,2,3-cd)pyrene	mg/kg	0.5	0.6	4.95	J	mg/kg	0.88	97.5% Chebyshev	Non-parametric, MH	0.88	97.5% Chebyshev	Non-parametric, MH
4,4'-DDE	mg/kg	0.04	0.06	2.6		mg/kg	0.13	97.5% Chebyshev	Non-parametric, MH	0.13	97.5% Chebyshev	Non-parametric, MH
4,4'-DDT	mg/kg	0.051	0.086	3.7		mg/kg	0.18	97.5% Chebyshev	Non-parametric, MH	0.18	97.5% Chebyshev	Non-parametric, MH
Aluminum	mg/kg	11,011	11,309	18,300		mg/kg	11,100	95% modified t	Non-parametric, M	11,100	95% modified t	Non-parametric, M
Antimony	mg/kg	4.0	7.7	424	J	mg/kg	13.9	95% Chebyshev	Non-parametric, MO	13.9	95% Chebyshev	Non-parametric, MO
Arsenic	mg/kg	5.4	5.7	32.2		mg/kg	5.8	95% modified t	Non-parametric, M	5.8	95% modified t	Non-parametric, M
Iron	mg/kg	21,212	21,830	64,000	J	mg/kg	21,844	95% modified t	Non-parametric, M	21,844	95% modified t	Non-parametric, M
Manganese	mg/kg	507	533	1,290		mg/kg	462	95% H-UCL	Lognormal	462	95% H-UCL	Lognormal
Thallium	mg/kg	0.32	0.41	1.8		mg/kg	0.17	95% Chebyshev	Non-parametric, MO	0.17	95% Chebyshev	Non-parametric, MO
Vanadium	mg/kg	19.3	19.7	28.5		mg/kg	19.5	95% modified t	Non-parametric, M	19.5	95% modified t	Non-parametric, M

Notes:

- Field duplicates were averaged and regarded as one sample entry. Lab duplicates were not included in the assessment. Nondetects were assumed to be half reporting limits.
- The EPCs were calculated using the ProUCL (Version 3.00.02) and the EPCs were selected in accordance with the ProUCL Version 3.0 User Guide (USEPA, 2004) and the Calculating Upper Confidence Limits for Exposure Point Concentrations at Hazardous Waste Sites (USEPA, 2002).
 - HE - highly skewed to extremely highly skewed (standard deviation of log-transformed data in the interval (2.0, 3.0] data set.
 - MH - moderately to highly skewed (standard deviation of log-transformed data in the interval (1.0, 2.0] data set.
 - MO - moderately skewed (standard deviation of log-transformed data in the interval (0.5,1] data set.
 - M - mildly skewed (standard deviation of log-transformed data less than or equal to 0.5) data set.
 - Q - qualifier
 - J = Estimated Value

TABLE G-2B
SOIL EXPOSURE POINT CONCENTRATION SUMMARY - SURFACE AND SUBSURFACE SOIL FOR SEAD-5'
SEAD-59 AND SEAD-71 PHASE II RI
SENECA ARMY DEPOT ACTIVITY

Scenario Timeframe:	Current/Future
Medium:	Soil
Exposure Medium:	Soil
Exposure Point:	SEAD-59

Chemical of Potential Concern	Units	Arithmetic Mean (1)	95% UCL of Normal Data (1)	Maximum Detected Concentration (1)	Q	EPC Units	Reasonable Maximum Exposure (2)			Central Tendency (2)		
							Medium EPC Value	Medium EPC Statistic	Medium EPC Rationale	Medium EPC Value	Medium EPC Statistic	Medium EPC Rationale
Surface and Subsurface Soil												
Benzo(a)anthracene	mg/kg	0.8	0.9	8.9	J	mg/kg	1.4	97.5 Chebyshev	Non-parametric, MH	1.4	97.5 Chebyshev	Non-parametric, MH
Benzo(a)pyrene	mg/kg	0.9	1.0	8.1	J	mg/kg	1.4	97.5 Chebyshev	Non-parametric, MH	1.4	97.5 Chebyshev	Non-parametric, MH
Benzo(b)fluoranthene	mg/kg	0.8	0.9	6.8	J	mg/kg	1.2	97.5 Chebyshev	Non-parametric, MH	1.2	97.5 Chebyshev	Non-parametric, MH
Benzo(k)fluoranthene	mg/kg	0.7	0.8	7.4	J	mg/kg	1.2	97.5 Chebyshev	Non-parametric, MH	1.2	97.5 Chebyshev	Non-parametric, MH
Chrysene	mg/kg	0.8	1.0	8.9	J	mg/kg	1.4	97.5 Chebyshev	Non-parametric, MH	1.4	97.5 Chebyshev	Non-parametric, MH
Dibenz(a,h)anthracene	mg/kg	0.3	0.3	1.7	J	mg/kg	0.40	95% Chebyshev	Non-parametric, MO	0.40	95% Chebyshev	Non-parametric, MO
Indeno(1,2,3-cd)pyrene	mg/kg	0.5	0.6	4.95	J	mg/kg	0.87	97.5% Chebyshev	Non-parametric, MH	0.87	97.5% Chebyshev	Non-parametric, MH
4,4'-DDE	mg/kg	0.04	0.06	2.6		mg/kg	0.12	97.5% Chebyshev	Non-parametric, MH	0.12	97.5% Chebyshev	Non-parametric, MH
4,4'-DDT	mg/kg	0.048	0.081	3.7		mg/kg	0.17	97.5% Chebyshev	Non-parametric, MH	0.17	97.5% Chebyshev	Non-parametric, MH
Aluminum	mg/kg	10,895	11,184	18,300	J	mg/kg	10,900	95% modified t	Non-parametric, M	10,900	95% modified t	Non-parametric, M
Antimony	mg/kg	3.7	7.2	424	J	mg/kg	13.0	95% Chebyshev	Non-parametric, MO	13.0	95% Chebyshev	Non-parametric, MO
Arsenic	mg/kg	5.4	5.6	32.2		mg/kg	5.7	95% modified t	Non-parametric, M	5.7	95% modified t	Non-parametric, M
Iron	mg/kg	21,152	21,741	64,000	J	mg/kg	21,753	95% modified t	Non-parametric, M	21,753	95% modified t	Non-parametric, M
Manganese	mg/kg	503	527	1,290	J	mg/kg	462	95% H-UCL	Lognormal	462	95% H-UCL	Lognormal
Thallium	mg/kg	0.33	0.42	1.8	J	mg/kg	0.26	95% Chebyshev	Non-parametric, MO	0.26	95% Chebyshev	Non-parametric, MO
Vanadium	mg/kg	19.0	19.5	28.5	J	mg/kg	19.4	95% modified t	Non-parametric, M	19.4	95% modified t	Non-parametric, M

Notes:

- Field duplicates were averaged and regarded as one sample entry. Lab duplicates were not included in the assessment. Nondetects were assumed to be half reporting limits.
- The EPCs were calculated using the ProUCL (Version 3.00.02) and the EPCs were selected in accordance with the ProUCL Version 3.0 User Guide (USEPA, 2004) and the Calculating Upper Confidence Limits for Exposure Point Concentrations at Hazardous Waste Sites (USEPA, 2002).
 - HE - highly skewed to extremely highly skewed (standard deviation of log-transformed data in the interval (2.0, 3.0] data set.
 - MH - moderately to highly skewed (standard deviation of log-transformed data in the interval (1.0, 2.0] data set.
 - MO - moderately skewed (standard deviation of log-transformed data in the interval (0.5,1] data set.
 - M - mildly skewed (standard deviation of log-transformed data less than or equal to 0.5) data set.
 - Q - qualifier
 - J = Estimated Value

TABLE G-2C
 AMBIENT AIR EXPOSURE POINT CONCENTRATIONS - SURFACE SOIL FOR SEAD-59
 SEAD-59 AND SEAD-71 PHASE II RI
 Seneca Army Depot Activity

Scenario Timeframe:	Current/Future
Medium:	Soil
Exposure Medium:	Air
Exposure Point:	SEAD-59

Equation for Air EPC from Surface Soil (mg/m³) = CS_{surf} x PM10 x CF

Variables:
 CS_{surf} = Chemical Concentration in Surface Soil, from EPC data (mg/kg)
 PM10 = Average Measured PM10 Concentration = 17 ug/m³
 CF = Conversion Factor = 1E-9 kg/ug

Analyte	Reasonable Maximum Exposure		Central Tendency Exposure	
	EPC Data for Surface Soil	Calculated Air EPC Surface Soil	EPC Data for Surface Soil	Calculated Air EPC Surface Soil
	(mg/kg)	(mg/m ³)	(mg/kg)	(mg/m ³)
Benzo(a)anthracene	1.4	2.3E-08	1.4	2.3E-08
Benzo(a)pyrene	1.4	2.4E-08	1.4	2.4E-08
Benzo(b)fluoranthene	1.3	2.1E-08	1.3	2.1E-08
Benzo(k)fluoranthene	1.1	1.9E-08	1.1	1.9E-08
Chrysene	1.4	2.4E-08	1.4	2.4E-08
Dibenz(a,h)anthracene	0.4	6.0E-09	0.4	6.0E-09
Indeno(1,2,3-cd)pyrene	0.9	1.5E-08	0.9	1.5E-08
4,4'-DDE	0.1	2.2E-09	0.1	2.2E-09
4,4'-DDT	0.2	3.1E-09	0.2	3.1E-09
Aluminum	11100.0	1.9E-04	11100.0	1.9E-04
Antimony	13.9	2.4E-07	13.9	2.4E-07
Arsenic	5.8	9.8E-08	5.8	9.8E-08
Iron	21844.0	3.7E-04	21844.0	3.7E-04
Manganese	462.0	7.9E-06	462.0	7.9E-06
Thallium	0.2	2.9E-09	0.2	2.9E-09
Vanadium	19.5	3.3E-07	19.5	3.3E-07

TABLE G-2D
 AMBIENT AIR EXPOSURE POINT CONCENTRATIONS - SURFACE AND SUBSURFACE SOIL FOR SEAD-59
 SEAD-59 AND SEAD-71 PHASE II RI
 Seneca Army Depot Activity

Scenario Timeframe:	Current/Future
Medium:	Soil
Exposure Medium:	Air
Exposure Point:	SEAD-59

Equation for Air EPC from Total Soils (mg/m³) = CStot x PM10 x CF

Variables:
 CStot = Chemical Concentration in Total Soils, from EPC data (mg/kg)
 PM10 = PM10 Concentration Calculated for Construction Worker= 954 ug/m³
 CF = Conversion Factor = 1E-9 kg/ug

Analyte	Reasonable Maximum Exposure		Central Tendency Exposure	
	EPC Data for Surface and Subsurface Soil (mg/kg)	Calculated Air EPC Surface and Subsurface Soil (mg/m ³)	EPC Data for Surface and Subsurface Soil (mg/kg)	Calculated Air EPC Surface and Subsurface Soil (mg/m ³)
Benzo(a)anthracene	1.4	1.3E-06	1.4	1.3E-06
Benzo(a)pyrene	1.4	1.3E-06	1.4	1.3E-06
Benzo(b)fluoranthene	1.2	1.1E-06	1.2	1.1E-06
Benzo(k)fluoranthene	1.2	1.1E-06	1.2	1.1E-06
Chrysene	1.4	1.3E-06	1.4	1.3E-06
Dibenz(a,h)anthracene	0.4	3.8E-07	0.4	3.8E-07
Indeno(1,2,3-cd)pyrene	0.87	8.3E-07	0.87	8.3E-07
4,4'-DDE	0.12	1.1E-07	0.12	1.1E-07
4,4'-DDT	0.17	1.6E-07	0.17	1.6E-07
Aluminum	10900	1.0E-02	10900	1.0E-02
Antimony	13	1.2E-05	13	1.2E-05
Arsenic	5.7	5.4E-06	5.7	5.4E-06
Iron	21753	2.1E-02	21753	2.1E-02
Manganese	462	4.4E-04	462	4.4E-04
Thallium	0.26	2.5E-07	0.26	2.5E-07
Vanadium	19.4	1.9E-05	19.4	1.9E-05

TABLE G-2E
GROUNDWATER EXPOSURE POINT CONCENTRATION SUMMARY - SEAD-59
SEAD-59 AND SEAD-71 PHASE II RI
SENECA ARMY DEPOT ACTIVITY

Scenario Timeframe:	Current/Future
Medium:	Groundwater
Exposure Medium:	Groundwater
Exposure Point:	Aquifer--Tap Water

Chemical of Potential Concern	Units	Arithmetic Mean	Maximum Detected Concentration mg/L	Maximum Qualifier	Reasonable Maximum Exposure			Central Tendency		
					Medium EPC Value (mg/L)	Medium EPC Statistic	Medium EPC Rationale	Medium EPC Value (mg/L)	Medium EPC Statistic	Medium EPC Rationale
Antimony	mg/L	0.0045	0.0086	J	0.0086	MDC	See note	0.0086	MDC	See note
Arsenic	mg/L	0.0033	0.002	J	0.002	MDC	See note	0.002	MDC	See note
Iron	mg/L	1.08	3.94	J	3.94	MDC	See note	3.94	MDC	See note
Manganese	mg/L	0.19	0.78	J	0.78	MDC	See note	0.78	MDC	See note
Thallium	mg/L	0.0064	0.004	J	0.004	MDC	See note	0.004	MDC	See note
Vanadium	mg/L	0.0021	0.00526	J	0.00526	MDC	See note	0.00526	MDC	See note

Notes:

1. Field duplicates were averaged and regarded as one sample entry. Lab duplicates were not included in the assessment.

Concentrations for nondetects were assumed to be half the detection limits.

2. The maximum detected concentration was used as EPC for the RME scenario.

As residential use of groundwater has been based on the assumption that a single private well can be placed anywhere in the contaminated plume, the MDC across several rounds of monitoring was used as the EPC for groundwater as a conservative step for both the RME and CT scenarios.

3. The maximum detected concentration was used as EPC for the CT scenario.

EPC = Exposure Point Concentration

MDC = Maximum Detected Concentration

RME = Reasonable Maximum Exposure

CT = Central Tendency

TABLE G-2F
SOIL EXPOSURE POINT CONCENTRATION SUMMARY - SEAD-59 STOCKPILE SOII
SEAD-59 AND SEAD-71 PHASE II RI
SENECA ARMY DEPOT ACTIVITY

Scenario Timeframe:	Current/Future
Medium:	Soil
Exposure Medium:	Soil
Exposure Point:	SEAD-59 Stockpile

Chemical of Potential Concern	Units	Arithmetic Mean (1)	95% UCL of Normal Data (1)	Maximum Detected Concentration (1)	Q	EPC Units	Reasonable Maximum Exposure (2)			Central Tendency (2)		
							Medium EPC Value	Medium EPC Statistic	Medium EPC Rationale	Medium EPC Value	Medium EPC Statistic	Medium EPC Rationale
Stockpile Soil												
Benzo(a)anthracene	mg/kg	5.0	5.7	14		mg/kg	6.8	95% Chebyshev	Non-parametric, MO	6.8	95% Chebyshev	Non-parametric, MO
Benzo(a)pyrene	mg/kg	5.7	6.5	16		mg/kg	7.9	95% Chebyshev	Non-parametric, MO	7.9	95% Chebyshev	Non-parametric, MO
Benzo(b)fluoranthene	mg/kg	4.3	4.9	11		mg/kg	5.1	95% Approximate Gamma	Approximate Gamma	5.1	95% Approximate Gamma	Approximate Gamma
Benzo(k)fluoranthene	mg/kg	4.2	4.9	13		mg/kg	6.7	97.5 Chebyshev	Non-parametric, MH	6.7	97.5 Chebyshev	Non-parametric, MH
Chrysene	mg/kg	5.0	5.7	13		mg/kg	6.8	95% Chebyshev	Non-parametric, MO	6.8	95% Chebyshev	Non-parametric, MO
Dibenz(a,h)anthracene	mg/kg	1.1	1.2	2.9	J	mg/kg	1.2	95% Student's t	Normal	1.2	95% Student's t	Normal
Indeno(1,2,3-cd)pyrene	mg/kg	3.0	3.5	8	J	mg/kg	3.5	95% Student's t	Normal	3.5	95% Student's t	Normal
Aluminum	mg/kg	10,701	10,974	13,400		mg/kg	10,800	95% modified t	Non-parametric, M	10,800	95% modified t	Non-parametric, M
Antimony	mg/kg	3.1	4.5	43.9	J	mg/kg	6.8	95% Chebyshev	Non-parametric, MO	6.8	95% Chebyshev	Non-parametric, MO
Arsenic	mg/kg	4.8	4.9	7.3	J	mg/kg	4.9	95% Approximate Gamma, H	Approximate Gamma, Lognormal	4.9	95% Approximate Gamma, H	Approximate Gamma, Lognormal
Iron	mg/kg	20,590	21,147	26,500	J	mg/kg	21,147	95% Student's t	Normal	21,147	95% Student's t	Normal
Lead	mg/kg	79	N/A	1,440	J	mg/kg	79	Mean	See Note	79	Mean	See Note
Manganese	mg/kg	522	557	1,220		mg/kg	489	95% modified t	Non-parametric, M	489	95% modified t	Non-parametric, M
Thallium	mg/kg	0.50	0.66	0.99	J	mg/kg	0.56	95% Chebyshev	Non-parametric, MO	0.56	95% Chebyshev	Non-parametric, MO
Vanadium	mg/kg	19.9	20.6	35.4		mg/kg	19.4	95% Approximate Gamma	Approximate Gamma	19.4	95% Approximate Gamma	Approximate Gamma

Notes:

- Field duplicates were averaged and regarded as one sample entry. Lab duplicates were not included in the assessment. Nondetects were assumed to be half reporting limits.
- The EPCs were calculated using the ProUCL (Version 3.00.02) and the EPCs were selected in accordance with the ProUCL Version 3.0 User Guide (USEPA, 2004) and the Calculating Upper Confidence Limits for Exposure Point Concentrations at Hazardous Waste Sites (USEPA, 2002). The average lead concentration was used as the lead EPC in accordance with the User's Guide for the Integrated Exposure Uptake Biokinetic Model for Lead in Children (IEUBK) Windows® Version – 32 bit Version (USEPA, 2002).
 - HE - highly skewed to extremely highly skewed (standard deviation of log-transformed data in the interval (2.0, 3.0]) data set.
 - MH - moderately to highly skewed (standard deviation of log-transformed data in the interval (1.0, 2.0]) data set.
 - MO - moderately skewed (standard deviation of log-transformed data in the interval (0.5,1] data set.
 - M - mildly skewed (standard deviation of log-transformed data less than or equal to 0.5) data set.
 - Q - qualifier
 - J = Estimated Value

TABLE G-2G
 AMBIENT AIR EXPOSURE POINT CONCENTRATIONS - SEAD-59 STOCKPILE SOIL
 SEAD-59 AND SEAD-71 PHASE II RI
 Seneca Army Depot Activity

Scenario Timeframe:	Current/Future
Medium:	Soil
Exposure Medium:	Air
Exposure Point:	SEAD-59 Stockpile

Equation for Air EPC from Stockpile Soil (mg/m³) = CSsurf x PM10 x CF

Variables:
 CSsurf = Chemical Concentration in Stockpile Soil, from EPC data (mg/kg)
 PM10 = Average Measured PM10 Concentration = 17 ug/m³
 CF = Conversion Factor = 1E-9 kg/ug

Analyte	Reasonable Maximum Exposure		Central Tendency Exposure	
	EPC Data for Stockpile Soil (mg/kg)	Calculated Air EPC Stockpile Soil (mg/m ³)	EPC Data for Stockpile Soil (mg/kg)	Calculated Air EPC Stockpile Soil (mg/m ³)
Benzo(a)anthracene	6.8	1.2E-07	6.8	1.2E-07
Benzo(a)pyrene	7.9	1.3E-07	7.9	1.3E-07
Benzo(b)fluoranthene	5.1	8.7E-08	5.1	8.7E-08
Benzo(k)fluoranthene	6.7	1.1E-07	6.7	1.1E-07
Chrysene	6.8	1.2E-07	6.8	1.2E-07
Dibenz(a,h)anthracene	1.2	2.0E-08	1.2	2.0E-08
Indeno(1,2,3-cd)pyrene	3.5	6.0E-08	3.5	6.0E-08
Aluminum	10800	1.8E-04	10800	1.8E-04
Antimony	6.8	1.2E-07	6.8	1.2E-07
Arsenic	4.9	8.3E-08	4.9	8.3E-08
Iron	21147	3.6E-04	21147	3.6E-04
Lead	79.18	1.3E-06	79.18	1.3E-06
Manganese	489	8.3E-06	489	8.3E-06
Thallium	0.56	9.5E-09	0.56	9.5E-09
Vanadium	19.4	3.3E-07	19.4	3.3E-07

TABLE G-2H
SOIL EXPOSURE POINT CONCENTRATION SUMMARY - SURFACE SOIL FOR SEAD-71 (FENCED AREA EXCLUDED)
SEAD-59 AND SEAD-71 PHASE II RI
SENECA ARMY DEPOT ACTIVITY

Scenario Timeframe:	Current/Future
Medium:	Soil
Exposure Medium:	Soil
Exposure Point:	SEAD-71

Chemical of Potential Concern	Units	Arithmetic Mean (1)	95% UCL of Normal Data (1)	Maximum Detected Concentration (1)	Q	EPC Units	Reasonable Maximum Exposure (2)			Central Tendency (2)		
							Medium EPC Value	Medium EPC Statistic	Medium EPC Rationale	Medium EPC Value	Medium EPC Statistic	Medium EPC Rationale
Surface Soil												
2-Methylnaphthalene	mg/kg	0.32	0.67	0.77	J	mg/kg	0.19	97.5% Chebyshev	Non-parametric, MH	0.19	97.5% Chebyshev	Non-parametric, MH
Benzo(a)anthracene	mg/kg	1.0	1.5	10		mg/kg	2.9	97.5% Chebyshev	Non-parametric, MH	2.9	97.5% Chebyshev	Non-parametric, MH
Benzo(a)pyrene	mg/kg	1.0	1.5	9		mg/kg	2.7	97.5% Chebyshev	Non-parametric, MH	2.7	97.5% Chebyshev	Non-parametric, MH
Benzo(b)fluoranthene	mg/kg	0.9	1.4	7.4		mg/kg	1.6	95% H-UCL	Lognormal, MH	1.6	95% H-UCL	Lognormal, MH
Benzo(k)fluoranthene	mg/kg	0.9	1.3	8		mg/kg	2.4	97.5% Chebyshev	Non-parametric, MH	2.4	97.5% Chebyshev	Non-parametric, MH
Chrysene	mg/kg	1.2	1.7	10		mg/kg	1.9	95% H-UCL	Lognormal, MH	1.9	95% H-UCL	Lognormal, MH
Dibenz(a,h)anthracene	mg/kg	0.35	0.47	2	J	mg/kg	0.7	95% Chebyshev	Non-parametric, MO	0.7	95% Chebyshev	Non-parametric, MO
Indeno(1,2,3-cd)pyrene	mg/kg	0.65	0.93	5.4	J	mg/kg	1.7	97.5% Chebyshev	Non-parametric, MH	1.7	97.5% Chebyshev	Non-parametric, MH
Naphthalene	mg/kg	0.30	0.46	1.1	J	mg/kg	0.19	95% Chebyshev	Non-parametric, MO	0.19	95% Chebyshev	Non-parametric, MO
Aluminum	mg/kg	11,506	12,058	15,900		mg/kg	12,150	95% Student t	Normal	12,150	95% Student t	Normal
Antimony	mg/kg	2.17	3.56	11.5	J	mg/kg	1.6	95% Chebyshev	Non-parametric, MO	1.6	95% Chebyshev	Non-parametric, MO
Arsenic	mg/kg	5.9	6.3	14.6		mg/kg	6.3	95% Approximate Gamma	Gamma	6.3	95% Approximate Gamma	Gamma
Iron	mg/kg	23,129	24,133	38,000		mg/kg	24,133	95% Student t	Normal	24,133	95% Student t	Normal
Lead	mg/kg	115	N/A	1,010		mg/kg	115	Mean	Mean	115	Mean	Mean
Manganese	mg/kg	581	620	1,330		mg/kg	548	95% Approximate Gamma	Gamma	548	95% Approximate Gamma	Gamma
Thallium	mg/kg	0.47	0.71	2.3		mg/kg	0.29	95% Chebyshev	Non-parametric, MO	0.29	95% Chebyshev	Non-parametric, MO
Vanadium	mg/kg	18.6	19.3	24		mg/kg	19.3	95% Student t	Normal	19.3	95% Student t	Normal

Notes:

- Field duplicates were averaged and regarded as one sample entry. Lab duplicates were not included in the assessment.
Nondetects were assumed to be half reporting limits.
- The EPCs were calculated using the ProUCL (Version 3.00.02) and the EPCs were selected in accordance with the ProUCL Version 3.0 User Guide (USEPA, 2004) and the Calculating Upper Confidence Limits for Exposure Point Concentrations at Hazardous Waste Sites (USEPA, 2002). The average lead concentration was used as the lead EPC in accordance with the User's Guide for the Integrated Exposure Uptake Biokinetic Model for Lead in Children (IEUBK) Windows® Version – 32 bit Version (USEPA, 2002).
HE - highly skewed to extremely highly skewed (standard deviation of log-transformed data in the interval (2.0, 3.0] data set.
MH - moderately to highly skewed (standard deviation of log-transformed data in the interval (1.0, 2.0] data set.
MO - moderately skewed (standard deviation of log-transformed data in the interval (0.5, 1.0] data set
M - mildly skewed (standard deviation of log-transformed data less than or equal to 0.5) data set.
Q - qualifier
J = Estimated Value

TABLE G-2I
SOIL EXPOSURE POINT CONCENTRATION SUMMARY - SURFACE AND SUBSURFACE SOIL FOR SEAD-71 (FENCED AREA EXCLUDED)
SEAD-59 AND SEAD-71 PHASE II RI
SENECA ARMY DEPOT ACTIVITY

Scenario Timeframe:	Current/Future
Medium:	Soil
Exposure Medium:	Soil
Exposure Point:	SEAD-71

Chemical of Potential Concern	Units	Arithmetic Mean (1)	95% UCL of Normal Data (1)	Maximum Detected Concentration (1)	Q	EPC Units	Reasonable Maximum Exposure (2)			Central Tendency (2)			
							Medium EPC Value	Medium EPC Statistic	Medium EPC Rationale	Medium EPC Value	Medium EPC Statistic	Medium EPC Rationale	
Surface and Subsurface Soil													
2-Methylnaphthalene	mg/kg	0.94	4.2	31		J	mg/kg	0.19	97.5% Chebyshev	Non-parametric, MH	0.19	97.5% Chebyshev	Non-parametric, MH
Benzo(a)anthracene	mg/kg	1.6	2.6	37			mg/kg	5.5	97.5% Chebyshev	Non-parametric, MH	5.5	97.5% Chebyshev	Non-parametric, MH
Benzo(a)pyrene	mg/kg	1.3	1.9	22			mg/kg	3.8	97.5% Chebyshev	Non-parametric, MH	3.8	97.5% Chebyshev	Non-parametric, MH
Benzo(b)fluoranthene	mg/kg	1.3	2.1	26			mg/kg	2.2	95% H-UCL	Lognormal, MH	2.2	95% H-UCL	Lognormal, MH
Benzo(k)fluoranthene	mg/kg	1	1.5	15		J	mg/kg	3	97.5% Chebyshev	Non-parametric, MH	3	97.5% Chebyshev	Non-parametric, MH
Chrysene	mg/kg	1.6	2.7	36			mg/kg	2.6	95% H-UCL	Lognormal, MH	2.6	95% H-UCL	Lognormal, MH
Dibenz(a,h)anthracene	mg/kg	0.5	0.8	9.8		J	mg/kg	1.5	97.5% Chebyshev	Non-parametric, MH	1.5	97.5% Chebyshev	Non-parametric, MH
Indeno(1,2,3-cd)pyrene	mg/kg	0.8	1.2	12		J	mg/kg	2.2	97.5% Chebyshev	Non-parametric, MH	2.2	97.5% Chebyshev	Non-parametric, MH
Naphthalene	mg/kg	0.69	2.6	17		J	mg/kg	0.19	97.5% Chebyshev	Non-parametric, MH	0.19	97.5% Chebyshev	Non-parametric, MH
Aluminum	mg/kg	11,493	11,997	15,900			mg/kg	12,150	95% Student t UCL	Normal	12,150	95% Student t UCL	Normal
Antimony	mg/kg	1.9	3.2	11.5		J	mg/kg	1.6	95% Chebyshev	Non-parametric, MO	1.6	95% Chebyshev	Non-parametric, MO
Arsenic	mg/kg	5.8	6.1	14.6			mg/kg	6.1	95% H-UCL	Lognormal	6.1	95% H-UCL	Lognormal
Iron	mg/kg	22,859	23,752	38,000			mg/kg	23,752	95% Student t UCL	Normal	23,752	95% Student t UCL	Normal
Lead	mg/kg	104.5	N/A	1,010			mg/kg	104.5	Mean	Mean	104.5	Mean	Mean
Manganese	mg/kg			1,330			mg/kg		95% Approximate Gamma	Gamma		95% Approximate Gamma	Gamma
		570	605					539			539		
Thallium	mg/kg	0.45	0.67	2.3			mg/kg	0.29	95% Chebyshev	Non-parametric, MO	0.29	95% Chebyshev	Non-parametric, MO
Vanadium	mg/kg	18.7	19.3	24.9			mg/kg	19.3	95% Student t UCL	Normal	19.3	95% Student t UCL	Normal

Notes:

- Field duplicates were averaged and regarded as one sample entry. Lab duplicates were not included in the assessment. Nondetects were assumed to be half reporting limits.
- The EPCs were calculated using the ProUCL (Version 3.00.02) and the EPCs were selected in accordance with the ProUCL Version 3.0 User Guide (USEPA, 2004) and the Calculating Upper Confidence Limits for Exposure Point Concentrations at Hazardous Waste Sites (USEPA, 2002). The average lead concentration was used as the lead EPC in accordance with the User's Guide for the Integrated Exposure Uptake Biokinetic Model for Lead in Children (IEUBK) Windows® Version – 32 bit Version (USEPA, 2002).
 - HE - highly skewed to extremely highly skewed (standard deviation of log-transformed data in the interval (2.0, 3.0] data set.
 - MH - moderately to highly skewed (standard deviation of log-transformed data in the interval (1.0, 2.0] data set.
 - MO - moderately skewed (standard deviation of log-transformed data in the interval (0.5, 1.0] data set
 - M - mildly skewed (standard deviation of log-transformed data less than or equal to 0.5) data set.
 - Q - qualifier
 - J = Estimated Value

TABLE G-2J
AMBIENT AIR EXPOSURE POINT CONCENTRATIONS - SURFACE SOIL FOR SEAD-71 (FENCED AREA EXCLUDED)
SEAD-59 AND SEAD-71 PHASE II RI
Seneca Army Depot Activity

Scenario Timeframe:	Current/Future
Medium:	Soil
Exposure Medium:	Air
Exposure Point:	SEAD-71

Equation for Air EPC from Surface Soil (mg/m³) = CS_{surf} x PM10 x CF

Variables:
 CS_{surf} = Chemical Concentration in Surface Soil, from EPC data (mg/kg)
 PM10 = Average Measured PM10 Concentration = 17 ug/m³
 CF = Conversion Factor = 1E-9 kg/ug

Analyte	Reasonable Maximum Exposure		Central Tendency Exposure	
	EPC Data for Surface Soil	Calculated Air EPC Surface Soil	EPC Data for Surface Soil	Calculated Air EPC Surface Soil
	(mg/kg)	(mg/m ³)	(mg/kg)	(mg/m ³)
2-Methylnaphthalene	0.185	3.1E-09	0.185	3.1E-09
Benzo(a)anthracene	2.9	4.9E-08	2.9	4.9E-08
Benzo(a)pyrene	2.7	4.6E-08	2.7	4.6E-08
Benzo(b)fluoranthene	1.6	2.7E-08	1.6	2.7E-08
Benzo(k)fluoranthene	2.4	4.1E-08	2.4	4.1E-08
Chrysene	1.9	3.2E-08	1.9	3.2E-08
Dibenz(a,h)anthracene	0.7	1.2E-08	0.7	1.2E-08
Indeno(1,2,3-cd)pyrene	1.7	2.9E-08	1.7	2.9E-08
Naphthalene	0.185	3.1E-09	0.185	3.1E-09
Aluminum	12150	2.1E-04	12150	2.1E-04
Antimony	1.6	2.7E-08	1.6	2.7E-08
Arsenic	6.3	1.1E-07	6.3	1.1E-07
Iron	24133	4.1E-04	24133	4.1E-04
Lead	115	2.0E-06	115	2.0E-06
Manganese	547.5	9.3E-06	547.5	9.3E-06
Thallium	0.29	4.9E-09	0.29	4.9E-09
Vanadium	19.3	3.3E-07	19.3	3.3E-07

TABLE G-2K
 AMBIENT AIR EXPOSURE POINT CONCENTRATIONS - SURFACE AND SUBSURFACE SOIL FOR SEAD-71 (FENCED AREA EXCLUDED)
 SEAD-59 AND SEAD-71 PHASE II RI
 Seneca Army Depot Activity

Scenario Timeframe:	Current/Future
Medium:	Soil
Exposure Medium:	Air
Exposure Point:	SEAD-71

Equation for Air EPC from Total Soils (mg/m ³) = CStot x PM10 x CF
Variables: CStot = Chemical Concentration in Total Soils, from EPC data (mg/kg) PM10 = PM10 Concentration Calculated for Construction Worker= 954 ug/m ³ CF = Conversion Factor = 1E-9 kg/ug

Analyte	Reasonable Maximum Exposure		Central Tendency Exposure	
	EPC Data for Surface and Subsurface Soil (mg/kg)	Calculated Air EPC Surface and Subsurface Soil (mg/m ³)	EPC Data for Surface and Subsurface Soil (mg/kg)	Calculated Air EPC Surface and Subsurface Soil (mg/m ³)
2-Methylnaphthalene	0.185	1.8E-07	0.185	1.8E-07
Benzo(a)anthracene	5.5	5.2E-06	5.5	5.2E-06
Benzo(a)pyrene	3.8	3.6E-06	3.8	3.6E-06
Benzo(b)fluoranthene	2.2	2.1E-06	2.2	2.1E-06
Benzo(k)fluoranthene	3	2.9E-06	3	2.9E-06
Chrysene	2.6	2.5E-06	2.6	2.5E-06
Dibenz(a,h)anthracene	1.5	1.4E-06	1.5	1.4E-06
Indeno(1,2,3-cd)pyrene	2.2	2.1E-06	2.2	2.1E-06
Naphthalene	0.185	1.8E-07	0.185	1.8E-07
Aluminum	12150	1.2E-02	12150	1.2E-02
Antimony	1.6	1.5E-06	1.6	1.5E-06
Arsenic	6.1	5.8E-06	6.1	5.8E-06
Iron	23752	2.3E-02	23752	2.3E-02
Lead	104.5	1.0E-04	104.5	1.0E-04
Manganese	538.5	5.1E-04	538.5	5.1E-04
Thallium	0.29	2.8E-07	0.29	2.8E-07
Vanadium	19.3	1.8E-05	19.3	1.8E-05

TABLE G-2L
GROUNDWATER EXPOSURE POINT CONCENTRATION SUMMARY - SEAD-71 (FENCED AREA EXCLUDED)
SEAD-59 AND SEAD-71 PHASE II RI
SENECA ARMY DEPOT ACTIVITY

Scenario Timeframe:	Current/Future
Medium:	Groundwater
Exposure Medium:	Groundwater
Exposure Point:	SEAD-71

Chemical of Potential Concern	Units	Arithmetic Mean (1)	Maximum Detected Concentration	Maximum Qualifier	EPC Units	RME (2)			CT (3)		
						Medium EPC Value	Medium EPC Statistic	Medium EPC Rationale	Medium EPC Value	Medium EPC Statistic	Medium EPC Rationale
4-Nitroaniline	ug/L	7.8	8.7	J	ug/L	8.7	MDC	See note	8.7	MDC	See note
Aluminum	ug/L	4,062	19,700		ug/L	19700	MDC	See note	19700	MDC	See note
Antimony	ug/L	3.94	6.52	J	ug/L	6.52	MDC	See note	6.52	MDC	See note
Arsenic	ug/L	3.1	2.7	J	ug/L	2.7	MDC	See note	2.7	MDC	See note
Chromium	ug/L	5.57	33.1		ug/L	33.1	MDC	See note	33.1	MDC	See note
Iron	ug/L	5,063	35,100		ug/L	35,100	MDC	See note	35,100	MDC	See note
Lead	ug/L	4.2	17.2		ug/L	17.2	MDC	See note	17.2	MDC	See note
Manganese	ug/L	633	2,680		ug/L	2,680	MDC	See note	2,680	MDC	See note
Thallium	ug/L	6.0	2.5	J	ug/L	2.5	MDC	See note	2.5	MDC	See note
Vanadium	ug/L	4.71	25.7	J	ug/L	25.7	MDC	See note	25.7	MDC	See note

Notes:

- Field duplicates were averaged and regarded as one sample entry. Lab duplicates were not included in the assessment. Concentrations for nondetects were assumed to be half the detection limits.
 - The maximum detected concentration was used as EPC for the RME scenario.
As residential use of groundwater has been based on the assumption that a single private well can be placed anywhere in the contaminated plume, the MDC across several rounds of monitoring was used as the EPC for groundwater as a conservative step for both the RME and CT scenarios.
 - The maximum detected concentration was used as EPC for the CT scenario.
- EPC = Exposure Point Concentration
MDC = Maximum Detected Concentration
RME = Reasonable Maximum Exposure
CT = Central Tendency

**TABLE G-3
EXPOSURE FACTOR ASSUMPTIONS FOR SEAD-59 AND SEAD-71
SEAD-59 AND SEAD-71 PHASE II RI
Seneca Army Depot Activity**

Scenario Timeframe:	Current/Future
Medium:	Soil
Exposure Medium:	Soil
Exposure Point:	SEAD-59 and SEAD-71
Receptor Population:	Adolescent Trespasser / Adolescent Visitor
Receptor Age:	Adolescent (11-16 yr)

EXPOSURE ROUTE	PARAMETER CODE	PARAMETER DEFINITION	UNITS	RME VALUE	RME RATIONALE	RME REFERENCE
Ingestion of Soil	EPC	Soil EPC	mg/kg		Surface soils.	See Table 6-4A/B/C & 6-5A/B
	BW	Body Weight	kg	50	Average weight for adolescent ages 11-16 (Table 7-3).	USEPA, 2002.
	IR	Ingestion Rate	mg/day	100	Default soil ingestion rate for adult.	USEPA, 2002.
	FI	Fraction Ingested	unitless	1	Assuming 100% ingestion from site	BPJ.
	EF	Exposure Frequency	days/yr	14	Assumption.	BPJ.
	ED	Exposure Duration	year	5	Assumption.	BPJ.
	CF	Conversion Factor	kg/mg	1.E-06		
	AT(Nc)	Averaging Time - Nc	days	1,825	5 years.	
	AT(Car)	Averaging Time - Car	days	25,550	70 years, default value for human life span	USEPA, 2002.
Dermal Contact of Soil	EPC	Soil EPC	mg/kg		Surface soils.	See Table 6-4A/B/C & 6-5A/B
	BW	Body Weight	kg	50	Average weight for adolescent ages 11-16 (Table 7-3).	USEPA, 2002.
	SA	Skin Contact Surface Area	cm ²	5,867	Average surface area for adolescent child (11-16) including head, hands, forearms, lower legs, and feet.	USEPA, 1997.
	AF	Soil/Skin Adherence Factor	mg/cm ² -event	0.07	Default value for adult.	USEPA, 2004.
	ABS	Dermal Absorption Fraction	unitless		Chemical-specific	USEPA, 2004.
	EV	Event Frequency	events/day	1	Default value for residential child.	USEPA, 2004.
	EF	Exposure Frequency	days/yr	14	Assumption.	BPJ.
	ED	Exposure Duration	year	5	Assumption.	BPJ.
	CF	Conversion Factor	kg/mg	1E-06		
	AT(Nc)	Averaging Time - Nc	days	1,825	5 years.	
	AT(Car)	Averaging Time - Car	days	25,550	70 years, default value for human life span.	USEPA, 2002.

Notes:

RME = Reasonable Maximum Exposure

Source References:

- BPJ: Best Professional Judgment.
- USEPA, 1997: Exposure Factors Handbook
- USEPA, 2002: Supplemental Guidance For Developing Soil Screening Levels For Superfund Sites. December.
- USEPA, 2004: Risk Assessment Guidance for Superfund Volume I: Human Health Evaluation Manual (Part E, Supplemental Guidance for Dermal Risk Assessment) Final.

Intake Equations:

Ingestion Daily Intake (DI) (mg/kg-day) = EPC x IR x EF x ED x CF x FI / (BW x AT)
Dermal DI (mg/kg-day) = EPC x SA x AF x ABS x EV x EF x ED x CF/(BW x AT)

**TABLE G-3
EXPOSURE FACTOR ASSUMPTIONS FOR SEAD-59 AND SEAD-71
SEAD-59 AND SEAD-71 PHASE II RI
Seneca Army Depot Activity**

Scenario Timeframe:	Current/Future
Medium:	Soil
Exposure Medium:	Air
Exposure Point:	SEAD-59 and SEAD-71
Receptor Population:	Adolescent Trespasser / Adolescent Visitor
Receptor Age:	Adolescent (11-16 yr)

EXPOSURE ROUTE	PARAMETER CODE	PARAMETER DEFINITION	UNITS	RME VALUE	RME RATIONALE	RME REFERENCE
Inhalation of Dust in Ambient Air	EPC	Air EPC	mg/m ³		Surface soils.	See Table 6-7A/B/C & 6-8A/B
	BW	Body Weight	kg	50	Average weight for adolescent ages 11-16 (Table 7-3).	USEPA, 2002.
	IR	Inhalation Rate	m ³ /day	1.6	Average inhalation rate for moderate activity is 1.6 m ³ /hr. Assuming 1 hr/day exposure.	USEPA, 1997 & BPJ.
	EF	Exposure Frequency	days/yr	14	Assumption.	BPJ.
	ED	Exposure Duration	year	5	Assumption.	BPJ.
	AT(Nc) AT(Car)	Averaging Time - Nc Averaging Time - Car	days days	1,825 25,550	6 years. 70 years, default value for human life span.	USEPA, 2002.

Notes:
RME = Reasonable Maximum Exposure

Source References:
 · BPJ: Best Professional Judgment.
 · USEPA, 1997: Exposure Factors Handbook
 · USEPA, 2002: Supplemental Guidance For Developing Soil Screening Levels For Superfund Sites. December.
 · USEPA, 2004: Risk Assessment Guidance for Superfund Volume I: Human Health Evaluation Manual (Part E, Supplemental Guidance for Dermal Risk Assessment) Final.

Intake Equation:
 Inhalation Daily Intake (DI) (mg/kg-day) = EPC x IR x EF x ED / (BW x AT)

**TABLE G-3
EXPOSURE FACTOR ASSUMPTIONS FOR SEAD-59 AND SEAD-71
SEAD-59 AND SEAD-71 PHASE II RI
Seneca Army Depot Activity**

Scenario Timeframe:	Current/Future
Medium:	Groundwater
Exposure Medium:	Groundwater
Exposure Point:	SEAD-59 and SEAD-71
Receptor Population:	Adolescent Trespasser / Adolescent Visitor
Receptor Age:	Adolescent (11-16 yr)

EXPOSURE ROUTE	PARAMETER CODE	PARAMETER DEFINITION	UNITS	RME VALUE	RME RATIONALE	RME REFERENCE
Intake of Groundwater	EPC	Groundwater EPC	mg/L		See Table 6-6A/B	See Table 6-6A/B
	BW	Body Weight	kg	50	Average weight for adolescent ages 11-16 (Table 7-3).	USEPA, 2002.
	IR	Intake Rate	L/day	2	95th percentile for 11-19 yr old.	USEPA, 1997.
	EF	Exposure Frequency	days/yr	14	Assumption.	BPJ.
	ED	Exposure Duration	year	5	Assumption.	BPJ.
	AT(Nc)	Averaging Time - Nc	days	1,825	5 years.	
	AT(Car)	Averaging Time - Car	days	25,550	70 years, default value for human life span.	USEPA, 2002.

Notes:

RME = Reasonable Maximum Exposure

Source References:

- BPJ: Best Professional Judgment.
- USEPA, 1997: Exposure Factors Handbook
- USEPA, 2002: Supplemental Guidance For Developing Soil Screening Levels For Superfund Sites. December.
- USEPA, 2004: Risk Assessment Guidance for Superfund Volume I: Human Health Evaluation Manual (Part E, Supplemental Guidance for Dermal Risk Assessment) Final.

Intake Equation:

Ingestion Daily Intake (DI) (mg/kg-day) = EPC x IR x EF x ED x CF x FI / (BW x AT)

**TABLE G-4A
NON-CANCER TOXICITY DATA -- ORAL/DERMAL
SEAD-59 AND SEAD-71**

Chemical of Potential Concern	Chronic/ Subchronic	Oral RfD Value	Oral RfD Units	Oral to Dermal Adjustment Factor (1)	Adjusted Dermal RfD (2)	Units	Primary Target Organ	Combined Uncertainty/Modifying Factors	Sources of RfD: Target Organ	Dates of RfD: Target Organ (3) (MM/DD/YY)
2-Methylnaphthalene	Chronic	4E-03	mg/kg-day	1	4.00E-03	mg/kg-day	Respiratory System	1000	IRIS	2/17/2006
4-nitroaniline	Chronic	3.00E-03	mg/kg-day	1	3.00E-03	mg/kg-day	N/A	N/A	PPRTV	10/8/2004
Acenaphthylene	N/A	N/A	N/A	1	N/A	N/A	N/A	N/A	N/A	N/A
Benzo(a)anthracene	N/A	N/A	N/A	1	N/A	N/A	N/A	N/A	N/A	N/A
Benzo(a)pyrene	N/A	N/A	N/A	1	N/A	N/A	N/A	N/A	N/A	N/A
Benzo(b)fluoranthene	N/A	N/A	N/A	1	N/A	N/A	N/A	N/A	N/A	N/A
Benzo(ghi)perylene	N/A	N/A	N/A	1	N/A	N/A	N/A	N/A	N/A	N/A
Benzo(k)fluoranthene	N/A	N/A	N/A	1	N/A	N/A	N/A	N/A	N/A	N/A
Carbazole	N/A	N/A	N/A	1	N/A	N/A	N/A	N/A	N/A	N/A
Chrysene	N/A	N/A	N/A	1	N/A	N/A	N/A	N/A	N/A	N/A
Dibenz(a,h)anthracene	N/A	N/A	N/A	1	N/A	N/A	N/A	N/A	N/A	N/A
Indeno(1,2,3-cd)pyrene	N/A	N/A	N/A	1	N/A	N/A	N/A	N/A	N/A	N/A
Naphthalene	Chronic	2E-02	mg/kg-day	1	2E-02	mg/kg-day	Body Weight	3000	IRIS	2/13/2006
Phenanthrene	N/A	N/A	N/A	1	N/A	N/A	N/A	N/A	N/A	N/A
4,4'-DDE	N/A	N/A	N/A	1	N/A	N/A	N/A	N/A	N/A	N/A
4,4'-DDT	Chronic	5E-04	mg/kg-day	1	5E-04	mg/kg-day	Liver	100	IRIS	12/03/2004
Heptachlor epoxide	Chronic	1.3E-05	mg/kg-day	1	1.3E-05	mg/kg-day	Liver	1000	IRIS	12/03/2004
Aluminum	Chronic	1.0E+00	mg/kg-day	1	1.0E+00	mg/kg-day	N/A	N/A	NCEA	8/26/1996
Antimony	Chronic	4E-04	mg/kg-day	0.15	6E-05	mg/kg-day	Whole Body Blood	1000	IRIS	12/03/2004
Arsenic	Chronic	3E-04	mg/kg-day	1	3E-04	mg/kg-day	Skin	3	IRIS	12/03/2004
Chromium (VI)	Chronic	3E-03	mg/kg-day	0.025	8E-05	mg/kg-day	Weight, Blood, and Other Tissues	900	IRIS	2/13/06
Iron	Chronic	3E-01	mg/kg-day	1	3E-01	mg/kg-day	N/A	1	NCEA	07/23/96
Manganese (4)	Chronic	2.3E-02	mg/kg-day	0.04	9E-04	mg/kg-day	Central Nervous	3	IRIS	12/23/2004

TABLE G-4A
NON-CANCER TOXICITY DATA -- ORAL/DERMAL
SEAD-59 AND SEAD-71

Chemical of Potential Concern	Chronic/Subchronic	Oral RfD Value	Oral RfD Units	Oral to Dermal Adjustment Factor (1)	Adjusted Dermal RfD (2)	Units	Primary Target Organ	Combined Uncertainty/Modifying Factors	Sources of RfD: Target Organ	Dates of RfD: Target Organ (3) (MM/DD/YY)
Thallium (5)	Chronic	6E-04	mg/kg-day	1	6E-04	mg/kg-day	Liver, Blood, Hair	3000	IRIS	12/23/2004
Vanadium	Chronic	1.0E-03	mg/kg-day	0.026	3E-05	mg/kg-day	N/A	N/A	NCEA, quoted in Region 3 and Region 9	2/13/06

N/A = Not Applicable

NCEA = National Center for Environmental Assessment

IRIS = Integrated Risk Information System

PPRTV = EPA's Provisional Peer Reviewed Toxicity Values

(1) Source: Supplemental Guidance for Dermal Risk Assessment. Part E of Risk Assessment Guidance for Superfund, Human Health Evaluation Manual (Volume I). Final. USEPA. 2004.

A default value of 1 was used if no value was available in the USEPA (2004) document.

(2) Dermal RfD = Oral RfD x Adjustment Factor

(3) For IRIS values, the date was the last time IRIS was checked.

For NCEA values, the date was the date of the article provided by NCEA.

For PPRTV values, the date was the date of the Region III RBC table, where the PPRTV was cited from.

(4) The chronic oral RfD for manganese was adjusted by using a modifying factor of 3 in accordance with the IRIS recommendation.

In addition, dietary exposure (assumed 5 mg/day) was subtracted. Thus, the RfD used in this risk assessment is 1/6 of the value listed in the IRIS.

(5) The chronic oral RfD for thallium was based on the chronic oral RfD of thallium sulfate adjusted for molecular weight differences.

**TABLE G-4B
NON-CANCER TOXICITY DATA -- INHALATION
SEAD-59 AND SEAD-71**

Chemical of Potential Concern	Chronic/ Subchronic	Value Inhalation RfC	Units	Adjusted Inhalation RfD (1)	Units	Primary Target Organ	Combined Uncertainty/Modifyin Factors	Sources of RfC:RfD: Target Organ	Dates (2) (MM/DD/YY)
2-Methylnaphthalene	N/A	N/A	N/A	N/A	N/A	N/A	N/A	N/A	N/A
4-nitroaniline	Chronic	N/A	N/A	1.00E-03	mg/kg-day	N/A	N/A	PPRTV	10/8/2004
Acenaphthylene	N/A	N/A	N/A	N/A	N/A	N/A	N/A	N/A	N/A
Benzo(a)anthracene	N/A	N/A	N/A	N/A	N/A	N/A	N/A	N/A	N/A
Benzo(a)pyrene	N/A	N/A	N/A	N/A	N/A	N/A	N/A	N/A	N/A
Benzo(b)fluoranthene	N/A	N/A	N/A	N/A	N/A	N/A	N/A	N/A	N/A
Benzo(ghi)perylene	N/A	N/A	N/A	N/A	N/A	N/A	N/A	N/A	N/A
Benzo(k)fluoranthene	N/A	N/A	N/A	N/A	N/A	N/A	N/A	N/A	N/A
Carbazole	N/A	N/A	N/A	N/A	N/A	N/A	N/A	N/A	N/A
Chrysene	N/A	N/A	N/A	N/A	N/A	N/A	N/A	N/A	N/A
Dibenz(a,h)anthracene	N/A	N/A	N/A	N/A	N/A	N/A	N/A	N/A	N/A
Indeno(1,2,3-cd)pyrene	N/A	N/A	N/A	N/A	N/A	N/A	N/A	N/A	N/A
Naphthalene	Chronic	3E-03	mg/m ³	8.57E-04	mg/kg-day	Nasal and Respiratory System	3000	IRIS	2/13/2006
Phenanthrene	N/A	N/A	N/A	N/A	N/A	N/A	N/A	N/A	N/A
4,4'-DDE	N/A	N/A	N/A	N/A	N/A	N/A	N/A	N/A	N/A
4,4'-DDT	N/A	N/A	N/A	N/A	N/A	N/A	N/A	N/A	N/A
Heptachlor epoxide	N/A	N/A	N/A	N/A	N/A	N/A	N/A	N/A	N/A
Aluminum	Chronic	5E-03	mg/m ³	1.43E-03	mg/kg-day	N/A	N/A	NCEA	6/20/1997
Antimony	N/A	N/A	N/A	N/A	N/A	N/A	N/A	N/A	N/A
Arsenic	N/A	N/A	N/A	N/A	N/A	N/A	N/A	N/A	N/A
Chromium (VI)	Chronic	1E-04	mg/m ³	3E-05	mg/kg-day	Respiratory System	300	IRIS	2/13/2006
Iron	N/A	N/A	N/A	N/A	N/A	N/A	N/A	N/A	N/A
Manganese	Chronic	5E-05	mg/m ³	1E-05	mg/kg-day	Central Nervous System	1000	IRIS	12/23/04
Thallium	N/A	N/A	N/A	N/A	N/A	N/A	N/A	N/A	N/A

TABLE G-4B
NON-CANCER TOXICITY DATA -- INHALATION
SEAD-59 AND SEAD-71

Chemical of Potential Concern	Chronic/ Subchronic	Value Inhalation RfC	Units	Adjusted Inhalation RfD (1)	Units	Primary Target Organ	Combined Uncertainty/Modifyin Factors	Sources of RfC:RfD: Target Organ	Dates (2) (MM/DD/YY)
Vanadium	N/A	N/A	N/A	N/A	N/A	N/A	N/A	N/A	N/A

Notes:

(1) Inhalation RfD was adjusted based on the assumption of 70 kg body weight and 20 m³/day inhalation rate.

(2) For IRIS values, the date was the last time IRIS was checked.

For PPRTV values, the date was the date of the Region III RBC table, where the PPRTV was cited from.

N/A = Not Applicable

IRIS = Integrated Risk Information System

PPRTV = EPA's Provisional Peer Reviewed Toxicity Values

**TABLE G-4C
CANCER TOXICITY DATA -- ORAL/DERMAL
SEAD-59 AND SEAD-71**

Chemical of Potential Concern	Oral Cancer Slope Factor	Oral Cancer Slope Factor Source	Oral to Dermal Adjustment Factor (1)	Adjusted Dermal Cancer Slope Factor (2)	Units	Weight of Evidence/ Cancer Guideline Description	Weight of Evidence Source	Date (3) (MM/DD/YY)
2-Methylnaphthalene	N/A	N/A	N/A	N/A	N/A	inadequate to assess human carcinogenic potential	IRIS	2/17/2006
4-nitroaniline	2.00E-02	PPRTV	1	2.00E-02	(mg/kg-day) ⁻¹	N/A	N/A	10/8/2004
Acenaphthylene	N/A	N/A	1	N/A	N/A	D	IRIS	12/03/2004
Benzo(a)anthracene	0.73	NCEA	1	0.73	(mg/kg-day) ⁻¹	B2	IRIS	10/8/2004
Benzo(a)pyrene	7.3	IRIS	1	7.3	(mg/kg-day) ⁻¹	B2	IRIS	12/03/2004
Benzo(b)fluoranthene	0.73	NCEA	1	0.73	(mg/kg-day) ⁻¹	B2	IRIS	10/8/2004
Benzo(ghi)perylene	N/A	N/A	1	N/A	N/A	D	IRIS	12/03/2004
Benzo(k)fluoranthene	0.073	NCEA	1	0.073	(mg/kg-day) ⁻¹	B2	IRIS	10/8/2004
Carbazole	0.02	HEAST, 1997	1	0.02	(mg/kg-day) ⁻¹	N/A	N/A	N/A
Chrysene	0.0073	NCEA	1	0.0073	(mg/kg-day) ⁻¹	B2	IRIS	10/8/2004
Dibenz(a,h)anthracene	7.3	NCEA	1	7.3	(mg/kg-day) ⁻¹	B2	IRIS	10/8/2004
Indeno(1,2,3-cd)pyrene	0.73	NCEA	1	0.73	(mg/kg-day) ⁻¹	B2	IRIS	10/8/2004
Naphthalene	N/A	N/A	N/A	N/A	N/A	C ⁴	IRIS	2/13/2006
Phenanthrene	N/A	N/A	1	N/A	N/A	D	IRIS	12/03/2004
4,4'-DDE	0.34	IRIS	1	0.34	(mg/kg-day) ⁻¹	B2	IRIS	12/03/2004
4,4'-DDT	0.34	IRIS	1	0.34	(mg/kg-day) ⁻¹	B2	IRIS	12/03/2004
Heptachlor epoxide	9.1	IRIS	1	9.1	(mg/kg-day) ⁻¹	B2	IRIS	12/03/2004
Aluminum	N/A	N/A	N/A	N/A	N/A	D	NCEA	6/20/1997
Antimony	N/A	N/A	0.15	N/A	N/A	N/A	N/A	N/A
Arsenic	1.5	IRIS	1	1.5	(mg/kg-day) ⁻¹	A	IRIS	12/03/2004
Chromium (VI)	N/A	N/A	N/A	N/A	N/A	A	IRIS	2/13/2006
Iron	N/A	N/A	1	N/A	N/A	N/A	N/A	N/A
Manganese	N/A	N/A	0.04	N/A	N/A	D	N/A	N/A

**TABLE G-4C
CANCER TOXICITY DATA -- ORAL/DERMAL
SEAD-59 AND SEAD-71**

Chemical of Potential Concern	Oral Cancer Slope Factor	Oral Cancer Slope Factor Source	Oral to Dermal Adjustment Factor (1)	Adjusted Dermal Cancer Slope Factor (2)	Units	Weight of Evidence/ Cancer Guideline Description	Weight of Evidence Source	Date (3) (MM/DD/YY)
Thallium	N/A	N/A	1	N/A	N/A	D	N/A	N/A
Vanadium	N/A	N/A	N/A	N/A	N/A	N/A	N/A	N/A

IRIS = Integrated Risk Information System

HEAST= Health Effects Assessment Summary Tables

NCEA = National Center for Environmental Assessment

PPRTV = EPA's Provisional Peer Reviewed Toxicity Values

EPA Group:

A - Human carcinogen

B1 - Probable human carcinogen - indicates that limited human data are available

B2 - Probable human carcinogen - indicates sufficient evidence in animals and inadequate or no evidence in humans

C - Possible human carcinogen

D - Not classifiable as a human carcinogen

E - Evidence of noncarcinogenicity

Notes:

(1) Source: USEPA (2004) Supplemental Guidance for Dermal Risk Assessment. Part E of Risk Assessment Guidance for Superfund, Human Health Evaluation Manual (Volume I). Final. A default value of 1 was used if no value was available in the USEPA (2004) document.

(2) Dermal Cancer Slope Factor = Oral Cancer Slope Factor/Adjustment Factor

(3) For IRIS values, the date was the last time IRIS was checked.

For PPRTV and NCEA values, the date was the date of the Region III RBC table, where the PPRTV and NCEA values were cited from.

**TABLE G-4D
CANCER TOXICITY DATA -- INHALATION
SEAD-59 AND SEAD-71**

Chemical of Potential Concern	Unit Risk	Units	Unit Risk Source	Adjustment (1)	Inhalation Cancer Slope Factor	Units	Weight of Evidence/ Cancer Guideline Description	Weight of Evidence Source	Date (2) (MM/DD/YY)
2-Methylnaphthalene	N/A	N/A	N/A	N/A	N/A	N/A	inadequate to assess human carcinogenic potential	IRIS	2/17/2006
4-nitroaniline	N/A	N/A	N/A	N/A	N/A	N/A	N/A	N/A	N/A
Acenaphthylene	N/A	N/A	N/A	N/A	N/A	N/A	D	IRIS	12/03/2004
Benzo(a)anthracene	N/A	N/A	N/A	N/A	N/A	N/A	B2	IRIS	12/03/2004
Benzo(a)pyrene	8.9E-04	(ug/m ³) ⁻¹	NCEA	3500	3.1	(mg/kg-day) ⁻¹	B2	IRIS	10/8/2004
Benzo(b)fluoranthene	N/A	N/A	N/A	N/A	N/A	N/A	B2	IRIS	12/03/2004
Benzo(ghi)perylene	N/A	N/A	N/A	N/A	N/A	N/A	D	IRIS	12/03/2004
Benzo(k)fluoranthene	N/A	N/A	N/A	N/A	N/A	N/A	B2	IRIS	12/03/2004
Carbazole	N/A	N/A	N/A	N/A	N/A	N/A	N/A	N/A	N/A
Chrysene	N/A	N/A	N/A	N/A	N/A	N/A	B2	IRIS	12/03/2004
Dibenz(a,h)anthracene	N/A	N/A	N/A	N/A	N/A	N/A	B2	IRIS	12/03/2004
Indeno(1,2,3-cd)pyrene	N/A	N/A	N/A	N/A	N/A	N/A	B2	IRIS	12/03/2004
Naphthalene	N/A	N/A	N/A	N/A	N/A	N/A	C ⁴	IRIS	2/13/2006
Phenanthrene	N/A	N/A	N/A	N/A	N/A	N/A	D	IRIS	12/03/2004
4,4'-DDE	N/A	N/A	N/A	N/A	N/A	N/A	B2	IRIS	12/03/2004
4,4'-DDT	9.7E-05	(ug/m ³) ⁻¹	IRIS	3500	3.4E-01	(mg/kg-day) ⁻¹	B2	IRIS	12/03/2004
Heptachlor epoxide	2.6E-03	(ug/m ³) ⁻¹	IRIS	3500	9.1E+00	(mg/kg-day) ⁻¹	B2	IRIS	12/03/2004
Aluminum	N/A	N/A	N/A	N/A	N/A	N/A	D	NCEA	6/20/1997
Antimony	N/A	N/A	N/A	N/A	N/A	N/A	N/A	N/A	N/A
Arsenic	4.3E-03	(ug/m ³) ⁻¹	IRIS	3500	1.5E+01	(mg/kg-day) ⁻¹	A	IRIS	12/03/2004
Chromium (VI)	1.2E-02	(ug/m ³) ⁻¹	IRIS	3500	4.2E+01	(mg/kg-day) ⁻¹	A	IRIS	2/13/2006
Iron	N/A	N/A	N/A	N/A	N/A	N/A	N/A	N/A	N/A
Manganese	N/A	N/A	N/A	N/A	N/A	N/A	D	IRIS	12/23/2004
Thallium	N/A	N/A	N/A	N/A	N/A	N/A	D	IRIS	12/23/2004
Vanadium	N/A	N/A	N/A	N/A	N/A	N/A	N/A	N/A	N/A

IRIS = Integrated Risk Information System

HEAST= Health Effects Assessment Summary Tables

NCEA = National Center for Environmental Assessment

Notes:

(1) The adjustment was based on a 70 kg body weight and 20 m³/day inhalation rate.

(2) For IRIS values, the date was the last time IRIS was checked. For NCEA values, the date was the date of the Region III RBC, where the NCEA was cited from.

EPA Group:

A - Human carcinogen

B1 - Probable human carcinogen - indicates that limited human data are available

B2 - Probable human carcinogen - indicates sufficient evidence in animals and inadequate or no evidence in humans

C - Possible human carcinogen

D - Not classifiable as a human carcinogen

E - Evidence of noncarcinogenicity

**TABLE G-5A
CALCULATION OF INTAKE AND RISK FROM THE INGESTION OF SOIL
REASONABLE MAXIMUM EXPOSURE (RME) - SEAD-59 SOIL
SEAD-59 AND SEAD-71 PHASE II RI
Seneca Army Depot Activity**

Equation for Intake (mg/kg-day) =	$\frac{EPC \times IR \times CF \times FI \times EF \times ED \times B}{BW \times AT}$	Equation for Hazard Quotient = Chronic Daily Intake (Nc)/Reference Dose
Variables (Assumptions for Each Receptor are Listed at the Bottom):		Equation for Cancer Risk = Chronic Daily Intake (Car) x Slope Factor
EPC = Exposure Point Concentration in Soil, mg/kg	EF = Exposure Frequency	
IR = Ingestion Rate	ED = Exposure Duration	
CF = Conversion Factor	BW = Bodyweight	
FI = Fraction Ingested	AT = Averaging Time	
	B = Bioavailability	

Analyte	Oral RfD (mg/kg-day)	Carc. Slope Oral (mg/kg-day) ⁻¹	Bioavailability (unitless)	EPC Surface Soil (mg/kg)	EPC from Total Soils (mg/kg)	Industrial Worker			Construction Worker			Adolescent Trespasser					
						Intake (mg/kg-day)		Hazard Quotient	Cancer Risk	Intake (mg/kg-day)		Hazard Quotient	Cancer Risk	Intake (mg/kg-day)		Hazard Quotient	Cancer Risk
						(Nc)	(Car)			(Nc)	(Car)			(Nc)	(Car)		
Benzo(a)anthracene	N/A	7.3E-01	1	1.4E+00	1.4E+00		4.79E-07	3E-07		6.46E-08	5E-08		7.51E-09	5E-09			
Benzo(a)pyrene	N/A	7.3E+00	1	1.4E+00	1.4E+00		4.89E-07	4E-06		6.46E-08	5E-07		7.67E-09	6E-08			
Benzo(b)fluoranthene	N/A	7.3E-01	1	1.3E+00	1.2E+00		4.37E-07	3E-07		5.54E-08	4E-08		6.85E-09	5E-09			
Benzo(k)fluoranthene	N/A	7.3E-02	1	1.1E+00	1.2E+00		3.84E-07	3E-08		5.54E-08	4E-09		6.03E-09	4E-10			
Chrysene	N/A	7.3E-03	1	1.4E+00	1.4E+00		4.89E-07	4E-09		6.46E-08	5E-10		7.67E-09	6E-11			
Dibenz(a,h)anthracene	N/A	7.3E+00	1	3.5E-01	4.0E-01		1.22E-07	9E-07		1.85E-08	1E-07		1.92E-09	1E-08			
Indeno(1,2,3-cd)pyrene	N/A	7.3E-01	1	8.8E-01	8.7E-01		3.06E-07	2E-07		4.01E-08	3E-08		4.80E-09	4E-09			
4,4'-DDE	N/A	3.4E-01	1	1.3E-01	1.2E-01		4.54E-08	2E-08		5.54E-09	2E-09		7.12E-10	2E-10			
4,4'-DDT	5.00E-04	3.4E-01	1	1.8E-01	1.7E-01	1.76E-07	6.29E-08	4E-04	2E-08	5.49E-07	7.84E-09	1E-03	3E-09	1.38E-08	9.86E-10	3E-05	3E-10
Aluminum	1.00E+00	N/A	1	1.1E+04	1.1E+04	1.09E-02		1E-02		3.52E-02	4E-02		8.52E-04	9E-04			
Antimony	4.00E-04	N/A	1	1.4E+01	1.3E+01	1.36E-05		3E-02		4.20E-05	1E-01		1.07E-06	3E-03			
Arsenic	3.00E-04	1.5E+00	1	5.8E+00	5.7E+00	5.63E-06	2.01E-06	2E-02	3E-06	1.84E-05	2.63E-07	6E-02	4E-07	4.41E-07	3.15E-08	1E-03	5E-08
Iron	3.00E-01	N/A	1	2.2E+04	2.2E+04	2.14E-02		7E-02		7.02E-02	2E-01		1.68E-03	6E-03			
Manganese	2.33E-02	N/A	1	4.6E+02	4.6E+02	4.52E-04		2E-02		1.49E-03	6E-02		3.54E-05	2E-03			
Thallium	6.47E-04	N/A	1	1.7E-01	2.6E-01	1.66E-07		3E-04		8.40E-07	1E-03		1.30E-08	2E-05			
Vanadium	1.00E-03	N/A	1	2.0E+01	1.9E+01	1.91E-05		2E-02		6.26E-05	6E-02		1.50E-06	1E-03			
Total Hazard Quotient and Cancer Risk:								2E-01	8E-06		6E-01	1E-06		1E-02	1E-07		

Assumptions for Industrial Worker		Assumptions for Construction Worker		Assumptions for Adolescent Trespasser	
CF =	1E-06 kg/mg	CF =	1E-06 kg/mg	CF =	1E-06 kg/mg
EPC =	EPC Surface Only	EPC =	EPC Surface and Subsurface	EPC =	EPC Surface Only
BW =	70 kg	BW =	70 kg	BW =	50 kg
IR =	100 mg/day	IR =	330 mg/day	IR =	100 mg/day
FI =	1 unitless	FI =	1 unitless	FI =	1 unitless
EF =	250 days/year	EF =	250 days/year	EF =	14 days/year
ED =	25 years	ED =	1 years	ED =	5 years
AT (Nc) =	9,125 days	AT (Nc) =	365 days	AT (Nc) =	1,825 days
AT (Car) =	25,550 days	AT (Car) =	25,550 days	AT (Car) =	25,550 days

Note: Cells in this table were intentionally left blank due to a lack of toxicity data.

NA= Information not available.

TABLE G-5B
CALCULATION OF INTAKE AND RISK FROM THE INGESTION OF SOIL
REASONABLE MAXIMUM EXPOSURE (RME) - SEAD-59 STOCKPILE SOIL
SEAD-59 AND SEAD-71 PHASE II RI
Seneca Army Depot Activity

Equation for Intake (mg/kg-day) =	$\frac{EPC \times IR \times CF \times FI \times EF \times ED \times B}{BW \times AT}$	Equation for Hazard Quotient = Chronic Daily Intake (Nc)/Reference Dose
Variables (Assumptions for Each Receptor are Listed at the Bottom):		Equation for Cancer Risk = Chronic Daily Intake (Car) x Slope Factor
EPC = Exposure Point Concentration in Soil, mg/kg	EF = Exposure Frequency	
IR = Ingestion Rate	ED = Exposure Duration	
CF = Conversion Factor	BW = Bodyweight	
FI = Fraction Ingested	B = Bioavailability	
	AT = Averaging Time	

Analyte	Oral RFD (mg/kg-day)	Carc. Slope Oral (mg/kg-day)-1	Bioavailability (unitless)	EPC Stockpile Soil (mg/kg)	Industrial Worker			Construction Worker			Adolescent Trespasser					
					Intake (mg/kg-day)		Hazard Quotient	Cancer Risk	Intake (mg/kg-day)		Hazard Quotient	Cancer Risk	Intake (mg/kg-day)		Hazard Quotient	Cancer Risk
					(Nc)	(Car)			(Nc)	(Car)			(Nc)	(Car)		
Benzo(a)anthracene	N/A	7.3E-01	1	6.8E+00		2.38E-06		2E-06		3.14E-07		2E-07		3.73E-08		3E-08
Benzo(a)pyrene	N/A	7.3E+00	1	7.9E+00		2.76E-06		2E-05		3.64E-07		3E-06		4.33E-08		3E-07
Benzo(b)fluoranthene	N/A	7.3E-01	1	5.1E+00		1.78E-06		1E-06		2.35E-07		2E-07		2.79E-08		2E-08
Benzo(k)fluoranthene	N/A	7.3E-02	1	6.7E+00		2.34E-06		2E-07		3.09E-07		2E-08		3.67E-08		3E-09
Chrysene	N/A	7.3E-03	1	6.8E+00		2.38E-06		2E-08		3.14E-07		2E-09		3.73E-08		3E-10
Dibenz(a,h)anthracene	N/A	7.3E+00	1	1.2E+00		4.19E-07		3E-06		5.54E-08		4E-07		6.58E-09		5E-08
Indeno(1,2,3-cd)pyrene	N/A	7.3E-01	1	3.5E+00		1.22E-06		9E-07		1.61E-07		1E-07		1.92E-08		1E-08
Aluminum	1.00E+00	N/A	1	1.1E+04	1.06E-02		1E-02		3.49E-02		3E-02		8.28E-04		8E-04	
Antimony	4.00E-04	N/A	1	6.8E+00	6.65E-06		2E-02		2.20E-05		5E-02		5.22E-07		1E-03	
Arsenic	3.00E-04	1.5E+00	1	4.9E+00	4.79E-06	1.71E-06	2E-02	3E-06	1.58E-05	2.26E-07	5E-02	3E-07	3.76E-07	2.68E-08	1E-03	4E-08
Iron	3.00E-01	N/A	1	2.1E+04	2.07E-02		7E-02		6.83E-02		2E-01		1.62E-03		5E-03	
Manganese	2.33E-02	N/A	1	4.9E+02	4.78E-04		2E-02		1.58E-03		7E-02		3.75E-05		2E-03	
Thallium	6.47E-04	N/A	1	5.6E-01	5.48E-07		8E-04		1.81E-06		3E-03		4.30E-08		7E-05	
Vanadium	1.00E-03	N/A	1	1.9E+01	1.90E-05		2E-02		6.26E-05		6E-02		1.49E-06		1E-03	
Total Hazard Quotient and Cancer Risk:							2E-01	3E-05			5E-01	4E-06			1E-02	5E-07
					Assumptions for Industrial Worker			Assumptions for Construction Worker			Assumptions for Adolescent Trespasser					
					CF =	1E-06 kg/mg	CF =	1E-06 kg/mg	CF =	1E-06 kg/mg						
					EPC=	EPC Surface Only	EPC=	EPC Surface and Subsurface	EPC=	EPC Surface Only						
					BW =	70 kg	BW =	70 kg	BW =	50 kg						
					IR =	100 mg/day	IR =	330 mg/day	IR =	100 mg/day						
					FI =	1 unitless	FI =	1 unitless	FI =	1 unitless						
					EF =	250 days/year	EF =	250 days/year	EF =	14 days/year						
					ED =	25 years	ED =	1 years	ED =	5 years						
					AT (Nc) =	9,125 days	AT (Nc) =	365 days	AT (Nc) =	1,825 days						
					AT (Car) =	25,550 days	AT (Car) =	25,550 days	AT (Car) =	25,550 days						

Note: Cells in this table were intentionally left blank due to a lack of toxicity data.

NA= Information not available.

**TABLE G-5C
CALCULATION OF INTAKE AND RISK FROM THE INGESTION OF SOIL
REASONABLE MAXIMUM EXPOSURE (RME) - SEAD-71 (FENCED AREA EXCLUDED)
SEAD-59 AND SEAD-71 PHASE II RI
Seneca Army Depot Activity**

Equation for Intake (mg/kg-day) =	$\frac{EPC \times IR \times CF \times FI \times EF \times ED \times B}{BW \times AT}$	
Variables (Assumptions for Each Receptor are Listed at the Bottom):		Equation for Hazard Quotient = Chronic Daily Intake (Nc)/Reference Dose
EPC = Exposure Point Concentration in Soil, mg/kg	EF = Exposure Frequency	Equation for Cancer Risk = Chronic Daily Intake (Car) x Slope Factor
IR = Ingestion Rate	ED = Exposure Duration	
CF = Conversion Factor	BW = Bodyweight	
FI = Fraction Ingested	B = Bioavailability	
	AT = Averaging Time	

Analyte	Oral RfD (mg/kg-day)	Carc. Slope Oral (mg/kg-day) ⁻¹	Bioavailability (unitless)	EPC Surface Soil (mg/kg)	EPC from Total Soils (mg/kg)	Industrial Worker			Construction Worker			Adolescent Trespasser					
						Intake (mg/kg-day)		Hazard Quotient	Cancer Risk	Intake (mg/kg-day)		Hazard Quotient	Cancer Risk	Intake (mg/kg-day)		Hazard Quotient	Cancer Risk
						(Nc)	(Car)			(Nc)	(Car)			(Nc)	(Car)		
2-Methylnaphthalene	4.00E-03	N/A	1	1.9E-01	1.9E-01	1.81E-07		5E-05		5.97E-07	1E-04		1.42E-08		4E-06		
Benzo(a)anthracene	N/A	7.3E-01	1	2.9E+00	5.5E+00		1.01E-06	7E-07		2.54E-07	2E-06			1.59E-08		1E-08	
Benzo(a)pyrene	N/A	7.3E+00	1	2.7E+00	3.8E+00		9.44E-07	7E-06		1.75E-07	1E-06			1.48E-08		1E-07	
Benzo(b)fluoranthene	N/A	7.3E-01	1	1.6E+00	2.2E+00		5.59E-07	4E-07		1.01E-07	7E-08			8.77E-09		6E-09	
Benzo(k)fluoranthene	N/A	7.3E-02	1	2.4E+00	3.0E+00		8.39E-07	6E-08		1.38E-07	1E-08			1.32E-08		1E-09	
Chrysene	N/A	7.3E-03	1	1.9E+00	2.6E+00		6.64E-07	5E-09		1.20E-07	9E-10			1.04E-08		8E-11	
Dibenz(a,h)anthracene	N/A	7.3E+00	1	7.0E-01	1.5E+00		2.45E-07	2E-06		6.92E-08	5E-07			3.84E-09		3E-08	
Indeno(1,2,3-cd)pyrene	N/A	7.3E-01	1	1.7E+00	2.2E+00		5.94E-07	4E-07		1.01E-07	7E-08			9.32E-09		7E-09	
Naphthalene	2.00E-02	N/A	1	1.9E-01	1.9E-01	1.81E-07		9E-06		5.97E-07	3E-05		1.42E-08		7E-07		
Aluminum	1.00E+00	N/A	1	1.2E+04	1.2E+04	1.19E-02		1E-02		3.92E-02	4E-02		9.32E-04		9E-04		
Antimony	4.00E-04	N/A	1	1.6E+00	1.6E+00	1.57E-06		4E-03		5.17E-06	1E-02		1.23E-07		3E-04		
Arsenic	3.00E-04	1.5E+00	1	6.3E+00	6.1E+00	6.16E-06	2.20E-06	2E-02	3E-06	1.97E-05	2.81E-07	7E-02	4E-07	4.83E-07	3.45E-08	2E-03	5E-08
Iron	3.00E-01	N/A	1	2.4E+04	2.4E+04	2.36E-02		8E-02		7.67E-02	3E-01			1.85E-03		6E-03	
Manganese	2.33E-02	N/A	1	5.5E+02	5.4E+02	5.36E-04		2E-02		1.74E-03	7E-02			4.20E-05		2E-03	
Thallium	6.47E-04	N/A	1	2.9E-01	2.9E-01	2.84E-07		4E-04		9.36E-07	1E-03			2.22E-08		3E-05	
Vanadium	1.00E-03	N/A	1	1.9E+01	1.9E+01	1.89E-05		2E-02		6.23E-05	6E-02			1.48E-06		1E-03	
Total Hazard Quotient and Cancer Risk:								2E-01	1E-05			5E-01	3E-06			1E-02	2E-07
						Assumptions for Industrial Worker			Assumptions for Construction Worker			Assumptions for Adolescent Trespasser					
						CF =	1E-06 kg/mg	CF =	1E-06 kg/mg	CF =	1E-06 kg/mg						
						EPC =	EPC Surface Only	EPC =	EPC Surface and Subsurface	EPC =	EPC Surface Only						
						BW =	70 kg	BW =	70 kg	BW =	50 kg						
						IR =	100 mg/day	IR =	330 mg/day	IR =	100 mg/day						
						FI =	1 unitless	FI =	1 unitless	FI =	1 unitless						
						EF =	250 days/year	EF =	250 days/year	EF =	14 days/year						
						ED =	25 years	ED =	1 years	ED =	5 years						
						AT (Nc) =	9,125 days	AT (Nc) =	365 days	AT (Nc) =	1,825 days						
						AT (Car) =	25,550 days	AT (Car) =	25,550 days	AT (Car) =	25,550 days						

Note: Cells in this table were intentionally left blank due to a lack of toxicity data.
NA= Information not available.

TABLE G-6A
CALCULATION OF ABSORBED DOSE AND RISK FROM DERMAL CONTACT TO SOIL
REASONABLE MAXIMUM EXPOSURE (RME) - SEAD-59 SOIL
SEAD-59 AND SEAD-71 PHASE II RI
Seneca Army Depot Activity

Equation for Intake (mg/kg-day) =	$\frac{EPC \times CF \times SA \times AF \times ABS \times EV \times EF \times ED}{BW \times AT}$	Equation for Hazard Quotient = Chronic Daily Intake (Nc)/Reference Dose
Variables (Assumptions for Each Receptor are Listed at the Bottom):		Equation for Cancer Risk = Chronic Daily Intake (Car) x Slope Factor
EPC = Exposure Point Concentration in Soil, mg/kg	EV = Event Frequency	
CF = Conversion Factor	EF = Exposure Frequency	
SA = Surface Area Contact	ED = Exposure Duration	
AF = Adherence Factor	BW = Bodyweight	
ABS = Absorption Factor	AT = Averaging Time	

Analyte	Dermal RfD (mg/kg-day)	Carc. Slope Dermal (mg/kg-day)-1	Absorption Factor* (unitless)	EPC Surface Soil (mg/kg)	EPC from Total Soils (mg/kg)	Industrial Worker			Construction Worker			Adolescent Trespasser					
						Absorbed Dose (mg/kg-day)		Hazard Quotient	Cancer Risk	Absorbed Dose (mg/kg-day)		Hazard Quotient	Cancer Risk	Absorbed Dose (mg/kg-day)		Hazard Quotient	Cancer Risk
						(Nc)	(Car)			(Nc)	(Car)			(Nc)	(Car)		
Benzo(a)anthracene	N/A	7.3E-01	1.3E-01	1.4E+00	1.4E+00		4.11E-07	3E-07		2.52E-08	2E-08		4.01E-09	2.93E-09			
Benzo(a)pyrene	N/A	7.3E+00	1.3E-01	1.4E+00	1.4E+00		4.20E-07	3E-06		2.52E-08	2E-07		4.10E-09	2.99E-08			
Benzo(b)fluoranthene	N/A	7.3E-01	1.3E-01	1.3E+00	1.2E+00		3.75E-07	3E-07		2.16E-08	2E-08		3.66E-09	2.67E-09			
Benzo(k)fluoranthene	N/A	7.3E-02	1.3E-01	1.1E+00	1.2E+00		3.30E-07	2E-08		2.16E-08	2E-09		3.22E-09	2.35E-10			
Chrysene	N/A	7.3E-03	1.3E-01	1.4E+00	1.4E+00		4.20E-07	3E-09		2.52E-08	2E-10		4.10E-09	2.99E-11			
Dibenz(a,h)anthracene	N/A	7.3E+00	1.3E-01	3.5E-01	4.0E-01		1.05E-07	8E-07		7.20E-09	5E-08		1.02E-09	7.47E-09			
Indeno(1,2,3-cd)pyrene	N/A	7.3E-01	1.3E-01	8.8E-01	8.7E-01		2.63E-07	2E-07		1.57E-08	1E-08		2.56E-09	1.87E-09			
4,4'-DDE	N/A	3.4E-01	3.0E-02	1.3E-01	1.2E-01		8.99E-09	3E-09		4.98E-10	2E-10		8.78E-11	2.98E-11			
4,4'-DDT	5.00E-04	3.4E-01	3.0E-02	1.8E-01	1.7E-01	3.49E-08	1.25E-08	7E-05	4E-09	4.94E-08	7.06E-10	1E-04	2E-10	1.70E-09	1.22E-10	3.40E-06	4.13E-11
Aluminum	1.00E+00	N/A	1.0E-03	1.1E+04	1.1E+04	7.17E-05		7E-05		1.06E-04	1E-04		3.50E-06	3.50E-06			
Antimony	6.00E-05	N/A	1.0E-03	1.4E+01	1.3E+01	8.98E-08		1E-03		1.26E-07	2E-03		4.38E-09	7.30E-05			
Arsenic	3.00E-04	1.5E+00	3E-02	5.8E+00	5.7E+00	1.11E-06	3.98E-07	4E-03	6E-07	1.66E-06	2.37E-08	6E-03	4E-08	5.43E-08	3.88E-09	1.81E-04	5.82E-09
Iron	3.00E-01	N/A	1E-03	2.2E+04	2.2E+04	1.41E-04		5E-04		2.11E-04	7E-04		6.88E-06	2.29E-05			
Manganese	9.33E-04	N/A	1E-03	4.6E+02	4.6E+02	2.98E-06		3E-03		4.48E-06	5E-03		1.46E-07	1.56E-04			
Thallium	6.47E-04	N/A	1E-03	1.7E-01	2.6E-01	1.10E-09		2E-06		2.52E-09	4E-06		5.36E-11	8.28E-08			
Vanadium	2.60E-05	N/A	1E-03	2.0E+01	1.9E+01	1.26E-07		5E-03		1.88E-07	7E-03		6.14E-09	2.36E-04			
Total Hazard Quotient and Cancer Risk:								1E-02	5E-06			2E-02	3E-07			7E-04	5E-08
						Assumptions for Industrial Worker			Assumptions for Construction Worker			Assumptions for Adolescent Trespasser					
						CF =	1E-06 kg/mg	CF =	1E-06 kg/mg	CF =	1E-06 kg/mg						
						CS =	EPC Surface Only	EPC =	EPC Surface and Subsurface	EPC =	EPC Surface Only						
						BW =	70 kg	BW =	70 kg	BW =	50 kg						
						SA =	3,300 cm ²	SA =	3,300 cm ²	SA =	5,867 cm ²						
						AF =	0.2 mg/cm ² -event	AF =	0.3 mg/cm ² -event	AF =	0.07 mg/cm ² -event						
						EV =	1 event/day	EV =	1 event/day	EV =	1 event/day						
						EF =	250 days/year	EF =	250 days/year	EF =	14 days/year						
						ED =	25 years	ED =	1 years	ED =	5 years						
						AT (Nc) =	9,125 days	AT (Nc) =	365 days	AT (Nc) =	1,825 days						
						AT (Car) =	25,550 days	AT (Car) =	25,550 days	AT (Car) =	25,550 days						

Note: Cells in this table were intentionally left blank due to a lack of toxicity data.

N/A= Information not available.

* Absorption factors from Exhibit 3-4 of USEPA (2004) Supplemental Guidance for Dermal Risk Assessment, Part E of Risk Assessment Guidance for Superfund, Human Health Evaluation Manual (Volume I).

Absorption factors for antimony and iron were assumed to be 0.001 in accordance with the USEPA Region 4 (2000)

Supplemental Guidance to RAGS: Region 4 Bulletins, Human Health Risk Assessment Bulletins (<http://www.epa.gov/region4/waste/ots/healthbul.htm>).

TABLE G-6B
CALCULATION OF ABSORBED DOSE AND RISK FROM DERMAL CONTACT TO SOIL
REASONABLE MAXIMUM EXPOSURE (RME) - SEAD-59 STOCKPILE SOIL
SEAD-59 AND SEAD-71 PHASE II RI
Seneca Army Depot Activity

Equation for Intake (mg/kg-day) = $\frac{EPC \times CF \times SA \times AF \times ABS \times EV \times EF \times ED}{BW \times AT}$	Equation for Hazard Quotient = Chronic Daily Intake (Nc)/Reference Dose
Variables (Assumptions for Each Receptor are Listed at the Bottom): EPC = Exposure Point Concentration in Soil, mg/kg CF = Conversion Factor SA = Surface Area Contact AF = Adherence Factor ABS = Absorption Factor	Equation for Cancer Risk = Chronic Daily Intake (Car) x Slope Factor
EV = Event Frequency EF = Exposure Frequency ED = Exposure Duration BW = Bodyweight AT = Averaging Time	

Analyte	Dermal RfD (mg/kg-day)	Carc. Slope Dermal (mg/kg-day)-1	Absorption Factor* (unitless)	EPC Stockpile Soil (mg/kg)	Industrial Worker			Construction Worker			Adolescent Trespasser					
					Absorbed Dose (mg/kg-day)		Hazard Quotient	Cancer Risk	Absorbed Dose (mg/kg-day)		Hazard Quotient	Cancer Risk	Absorbed Dose (mg/kg-day)		Hazard Quotient	Cancer Risk
					(Nc)	(Car)			(Nc)	(Car)			(Nc)	(Car)		
Benzo(a)anthracene	N/A	7.3E-01	1.3E-01	6.8E+00		2.04E-06		1E-06	1.22E-07		9E-08		1.99E-08		1.45E-08	
Benzo(a)pyrene	N/A	7.3E+00	1.3E-01	7.9E+00		2.37E-06		2E-05	1.42E-07		1E-06		2.31E-08		1.69E-07	
Benzo(b)fluoranthene	N/A	7.3E-01	1.3E-01	5.1E+00		1.53E-06		1E-06	9.17E-08		7E-08		1.49E-08		1.09E-08	
Benzo(k)fluoranthene	N/A	7.3E-02	1.3E-01	6.7E+00		2.01E-06		1E-07	1.21E-07		9E-09		1.96E-08		1.43E-09	
Chrysene	N/A	7.3E-03	1.3E-01	6.8E+00		2.04E-06		1E-08	1.22E-07		9E-10		1.99E-08		1.45E-10	
Dibenz(a,h)anthracene	N/A	7.3E+00	1.3E-01	1.2E+00		3.60E-07		3E-06	2.16E-08		2E-07		3.51E-09		2.56E-08	
Indeno(1,2,3-cd)pyrene	N/A	7.3E-01	1.3E-01	3.5E+00		1.05E-06		8E-07	6.30E-08		5E-08		1.02E-08		7.47E-09	
Aluminum	1.00E+00	N/A	1.0E-03	1.1E+04	6.97E-05		7E-05		1.05E-04		1E-04		3.40E-06		3.40E-06	
Antimony	6.00E-05	N/A	1.0E-03	6.8E+00	4.39E-08		7E-04		6.59E-08		1E-03		2.14E-09		3.57E-05	
Arsenic	3.00E-04	1.5E+00	3.0E-02	4.9E+00	9.49E-07	3.39E-07	3E-03	5E-07	1.42E-06	2.03E-08	5E-03	3E-08	4.63E-08	3.31E-09	1.54E-04	
Iron	3.00E-01	N/A	1.0E-03	2.1E+04	1.37E-04		5E-04		2.05E-04		7E-04		6.66E-06		2.22E-05	
Manganese	9.33E-04	N/A	1E-03	4.9E+02	3.16E-06		3E-03		4.74E-06		5E-03		1.54E-07		1.65E-04	
Thallium	6.47E-04	N/A	1E-03	5.6E-01	3.62E-09		6E-06		5.42E-09		8E-06		1.76E-10		2.73E-07	
Vanadium	2.60E-05	N/A	1E-03	1.9E+01	1.25E-07		5E-03		1.88E-07		7E-03		6.11E-09		2.35E-04	
Total Hazard Quotient and Cancer Risk:							1E-02	2E-05			2E-02	1E-06			6E-04	2E-07

Assumptions for Industrial Worker		Assumptions for Construction Worker		Assumptions for Adolescent Trespasser	
CF =	1E-06 kg/mg	CF =	1E-06 kg/mg	CF =	1E-06 kg/mg
CS =	EPC Surface Only	EPC =	EPC Surface and Subsurface	EPC =	EPC Surface Only
BW =	70 kg	BW =	70 kg	BW =	50 kg
SA =	3,300 cm ²	SA =	3,300 cm ²	SA =	5,867 cm ²
AF =	0.2 mg/cm ² -event	AF =	0.3 mg/cm ² -event	AF =	0.07 mg/cm ² -event
EV =	1 event/day	EV =	1 event/day	EV =	1 event/day
EF =	250 days/year	EF =	250 days/year	EF =	14 days/year
ED =	25 years	ED =	1 years	ED =	5 years
AT (Nc) =	9,125 days	AT (Nc) =	365 days	AT (Nc) =	1,825 days
AT (Car) =	25,550 days	AT (Car) =	25,550 days	AT (Car) =	25,550 days

Note: Cells in this table were intentionally left blank due to a lack of toxicity data.

N/A= Information not available.

* Absorption factors from Exhibit 3-4 of USEPA (2004) Supplemental Guidance for Dermal Risk Assessment, Part E of Risk Assessment Guidance for Superfund, Human Health Evaluation Manual (Volume I).

Absorption factors for antimony and iron were assumed to be 0.001 in accordance with the USEPA Region 4 (2000)

Supplemental Guidance to RAGS: Region 4 Bulletins, Human Health Risk Assessment Bulletins (<http://www.epa.gov/region4/waste/ots/healthbul.htm>).

**TABLE G-6C
CALCULATION OF ABSORBED DOSE AND RISK FROM DERMAL CONTACT TO SOIL
REASONABLE MAXIMUM EXPOSURE (RME) - SEAD-71 (FENCED AREA EXCLUDED)
SEAD-59 AND SEAD-71 PHASE II RI
Seneca Army Depot Activity**

Equation for Intake (mg/kg-day) =	$\frac{EPC \times CF \times SA \times AF \times ABS \times EV \times EF \times ED}{BW \times AT}$	Equation for Hazard Quotient = Chronic Daily Intake (Nc)/Reference Dose Equation for Cancer Risk = Chronic Daily Intake (Car) x Slope Factor
Variables (Assumptions for Each Receptor are Listed at the Bottom):		
EPC = Chemical Concentration in Soil, mg/kg	EV = Event Frequency	
CF = Conversion Factor	EF = Exposure Frequency	
SA = Surface Area Contact	ED = Exposure Duration	
AF = Adherence Factor	BW = Bodyweight	
ABS = Absorption Factor	AT = Averaging Time	

Analyte	Dermal RfD (mg/kg-day)	Carc. Slope Dermal (mg/kg-day)-1	Absorption Factor* (unitless)	EPC Surface Soil (mg/kg)	EPC from Total Soils (mg/kg)	Industrial Worker				Construction Worker			Adolescent Trespasser					
						Absorbed Dose (mg/kg-day)		Hazard Quotient	Cancer Risk	Absorbed Dose (mg/kg-day)		Hazard Quotient	Cancer Risk	Absorbed Dose (mg/kg-day)		Hazard Quotient	Cancer Risk	
						(Nc)	(Car)			(Nc)	(Car)			(Nc)	(Car)			
2-Methylnaphthalene	4.00E-03	N/A	1.3E-01	1.9E-01	1.9E-01	1.55E-07		4E-05		2.33E-07		6E-05		7.58E-09		1.89E-06		
Benzo(a)anthracene	N/A	7.3E-01	1.3E-01	2.9E+00	5.5E+00		8.70E-07		6E-07		9.89E-08		7E-08		8.48E-09		6.19E-09	
Benzo(a)pyrene	N/A	7.3E+00	1.3E-01	2.7E+00	3.8E+00		8.10E-07		6E-06		6.84E-08		5E-07		7.90E-09		5.77E-08	
Benzo(b)fluoranthene	N/A	7.3E-01	1.3E-01	1.6E+00	2.2E+00		4.80E-07		4E-07		3.96E-08		3E-08		4.68E-09		3.42E-09	
Benzo(k)fluoranthene	N/A	7.3E-02	1.3E-01	2.4E+00	3.0E+00		7.20E-07		5E-08		5.40E-08		4E-09		7.02E-09		5.13E-10	
Chrysene	N/A	7.3E-03	1.3E-01	1.9E+00	2.6E+00		5.70E-07		4E-09		4.68E-08		3E-10		5.56E-09		4.06E-11	
Dibenz(a,h)anthracene	N/A	7.3E+00	1.3E-01	7.0E-01	1.5E+00		2.10E-07		2E-06		2.70E-08		2E-07		2.05E-09		1.49E-08	
Indeno(1,2,3-cd)pyrene	N/A	7.3E-01	1.3E-01	1.7E+00	2.2E+00		5.10E-07		4E-07		3.96E-08		3E-08		4.97E-09		3.63E-09	
Naphthalene	2.00E-02	N/A	1.3E-01	1.9E-01	1.9E-01	1.55E-07		8E-06		2.33E-07		1E-05		7.58E-09		3.79E-07		
Aluminum	1.00E+00	N/A	1E-03	1.2E+04	1.2E+04	7.85E-05		8E-05		1.18E-04		1E-04		3.83E-06		3.83E-06		
Antimony	6.00E-05	N/A	1E-03	1.6E+00	1.6E+00	1.03E-08		2E-04		1.55E-08		3E-04		5.04E-10		8.40E-06		
Arsenic	3.00E-04	1.5E+00	3E-02	6.3E+00	6.1E+00	1.22E-06	4.36E-07	4E-03	7E-07	1.77E-06	2.53E-08	6E-03	4E-08	5.95E-08	4.25E-09	1.98E-04	6.38E-09	
Iron	3.00E-01	N/A	1E-03	2.4E+04	2.4E+04	1.56E-04		5E-04		2.30E-04		8E-04		7.60E-06		2.53E-05		
Manganese	9.33E-04	N/A	1E-03	5.5E+02	5.4E+02	3.54E-06		4E-03		5.22E-06		6E-03		1.72E-07		1.85E-04		
Thallium	6.47E-04	N/A	1E-03	2.9E-01	2.9E-01	1.87E-09		3E-06		2.81E-09		4E-06		9.14E-11		1.41E-07		
Vanadium	2.60E-05	N/A	1E-03	1.9E+01	1.9E+01	1.25E-07		5E-03		1.87E-07		7E-03		6.08E-09		2.34E-04		
Total Hazard Quotient and Cancer Risk:								1E-02	1E-05			2E-02	9E-07			7E-04	9E-08	
						Assumptions for Industrial Worker			Assumptions for Construction Worker			Assumptions for Adolescent Trespasser						
						CF =	1E-06 kg/mg	CF =	1E-06 kg/mg	CF =	1E-06 kg/mg							
						CS =	EPC Surface Only	EPC =	EPC Surface and Subsurface	EPC =	EPC Surface Only							
						BW =	70 kg	BW =	70 kg	BW =	50 kg							
						SA =	3,300 cm ²	SA =	3,300 cm ²	SA =	5,867 cm ²							
						AF =	0.2 mg/cm ² -event	AF =	0.3 mg/cm ² -event	AF =	0.07 mg/cm ² -event							
						EV =	1 event/day	EV =	1 event/day	EV =	1 event/day							
						EF =	250 days/year	EF =	250 days/year	EF =	14 days/year							
						ED =	25 years	ED =	1 years	ED =	5 years							
						AT (Nc) =	9,125 days	AT (Nc) =	365 days	AT (Nc) =	1,825 days							
						AT (Car) =	25,550 days	AT (Car) =	25,550 days	AT (Car) =	25,550 days							

Note: Cells in this table were intentionally left blank due to a lack of toxicity data.

NA= Information not available.

* Absorption factors from Exhibit 3-4 of USEPA (2004) Supplemental Guidance for Dermal Risk Assessment, Part E of Risk Assessment Guidance for Superfund, Human Health Evaluation Manual (Volume I).

Absorption factor for iron was assumed to be 0.001 in accordance with the USEPA Region 4 (2000)

Supplemental Guidance to RAGS: Region 4 Bulletins, Human Health Risk Assessment Bulletins (<http://www.epa.gov/region4/waste/ots/healthbul.htm>).

**TABLE G-7A
CALCULATION OF INTAKE AND RISK FROM INHALATION OF DUST IN AMBIENT AIR
REASONABLE MAXIMUM EXPOSURE (RME) - SEAD-59 SOIL
SEAD-59 AND SEAD-71 PHASE II RI
Seneca Army Depot Activity**

Equation for Intake (mg/kg-day) = $\frac{EPC \times IR \times EF \times ED}{BW \times AT}$	Equation for Hazard Quotient = Chronic Daily Intake (Nc)/Reference Dose
Variables (Assumptions for Each Receptor are Listed at the Bottom): EPC = EPC in Air, mg/m3 IR = Inhalation Rate EF = Exposure Frequency	Equation for Cancer Risk = Chronic Daily Intake (Car) x Slope Factor
ED = Exposure Duration BW = Bodyweight AT = Averaging Time	

Analyte	Inhalation RID (mg/kg-day)	Carc. Slope Inhalation (mg/kg-day)-1	Air EPC from Surface Soil (mg/m3)	Air EPC from Total Soils (mg/m3)	Industrial Worker			Construction Worker			Adolescent Trespasser					
					Intake (mg/kg-day)		Hazard Quotient	Cancer Risk	Intake (mg/kg-day)		Hazard Quotient	Cancer Risk	Intake (mg/kg-day)		Hazard Quotient	Cancer Risk
					(Nc)	(Car)			(Nc)	(Car)			(Nc)	(Car)		
Benzo(a)anthracene	N/A	N/A	2.3E-08	1.3E-06												
Benzo(a)pyrene	N/A	3.10E+00	2.4E-08	1.3E-06		1.66E-09		5E-09		3.73E-09		1E-08		2.09E-12		6E-12
Benzo(b)fluoranthene	N/A	N/A	2.1E-08	1.1E-06												
Benzo(k)fluoranthene	N/A	N/A	1.9E-08	1.1E-06												
Chrysene	N/A	N/A	2.4E-08	1.3E-06												
Dibenz(a,h)anthracene	N/A	N/A	6.0E-09	3.8E-07												
Indeno(1,2,3-cd)pyrene	N/A	N/A	1.5E-08	8.3E-07												
4,4'-DDE	N/A	N/A	2.2E-09	1.1E-07												
4,4'-DDT	N/A	3.40E-01	3.1E-09	1.6E-07		2.14E-10		7E-11		4.53E-10		2E-10		2.68E-13		9E-14
Aluminum	1.43E-03	N/A	1.9E-04	1.0E-02	3.69E-05		3E-02		2.03E-03		1E+00		2.32E-07		2E-04	
Antimony	N/A	N/A	2.4E-07	1.2E-05												
Arsenic	N/A	1.51E+01	9.8E-08	5.4E-06		6.83E-09		1E-07		1.52E-08		2E-07		8.57E-12		1E-10
Iron	N/A	N/A	3.7E-04	2.1E-02												
Manganese	1.43E-05	N/A	7.9E-06	4.4E-04	1.54E-06		1E-01		8.62E-05		6E+00		9.64E-09		7E-04	
Thallium	N/A	N/A	2.9E-09	2.5E-07												
Vanadium	N/A	N/A	3.3E-07	1.9E-05												
Total Hazard Quotient and Cancer Risk:							1E-01	1E-07			7E+00	2E-07		8E-04	1E-10	
					Assumptions for Industrial Worker			Assumptions for Construction Worker			Assumptions for Adolescent Trespasser					
					CA =	EPC Surface Only	CA =	EPC Surface and Sub-Surface	CA =	EPC Surface Only						
					BW =	70 kg	BW =	70 kg	BW =	50 kg						
					IR =	20 m3/day	IR =	20 m3/day	IR =	1.6 m3/day						
					EF =	250 days/year	EF =	250 days/year	EF =	14 days/year						
					ED =	25 years	ED =	1 year	ED =	5 years						
					AT (Nc) =	9,125 days	AT (Nc) =	365 days	AT (Nc) =	1,825 days						
					AT (Car) =	25,550 days	AT (Car) =	25,550 days	AT (Car) =	25,550 days						

Note: Cells in this table were intentionally left blank due to a lack of toxicity data.
NA= Information not available.

**TABLE G-7B
CALCULATION OF INTAKE AND RISK FROM INHALATION OF DUST IN AMBIENT AIR
REASONABLE MAXIMUM EXPOSURE (RME) - SEAD-59 STOCKPILE SOIL
SEAD-59 AND SEAD-71 PHASE II RI
Seneca Army Depot Activity**

Equation for Intake (mg/kg-day) = $\frac{CA \times IR \times EF \times ED}{BW \times AT}$	Equation for Hazard Quotient = Chronic Daily Intake (Nc)/Reference Dose
Variables (Assumptions for Each Receptor are Listed at the Bottom): CA = Chemical Concentration in Air, Calculated from Air EPC Data IR = Inhalation Rate EF = Exposure Frequency	Equation for Cancer Risk = Chronic Daily Intake (Car) x Slope Factor
ED = Exposure Duration BW = Bodyweight AT = Averaging Time	

Analyte	Inhalation RfD (mg/kg-day)	Carc. Slope Inhalation (mg/kg-day) ⁻¹	Air EPC from Stockpile Soil (mg/m3)	Industrial Worker			Construction Worker			Adolescent Trespasser					
				Intake (mg/kg-day)		Hazard Quotient	Cancer Risk	Intake (mg/kg-day)		Hazard Quotient	Cancer Risk	Intake (mg/kg-day)		Hazard Quotient	Cancer Risk
				(Nc)	(Car)			(Nc)	(Car)			(Nc)	(Car)		
Benzo(a)anthracene	N/A	N/A	1.2E-07												
Benzo(a)pyrene	N/A	3.10E+00	1.3E-07		9.39E-09			3.75E-10		1E-09			1.18E-11		4E-11
Benzo(b)fluoranthene	N/A	N/A	8.7E-08												
Benzo(k)fluoranthene	N/A	N/A	1.1E-07												
Chrysene	N/A	N/A	1.2E-07												
Dibenz(a,h)anthracene	N/A	N/A	2.0E-08												
Indeno(1,2,3-cd)pyrene	N/A	N/A	6.0E-08												
Aluminum	1.43E-03	N/A	1.8E-04	3.59E-05		3E-02		3.59E-05		3E-02		2.25E-07		2E-04	
Antimony	N/A	N/A	1.2E-07												
Arsenic	N/A	1.51E+01	8.3E-08		5.82E-09			2.33E-10		4E-09			7.30E-12		1E-10
Iron	N/A	N/A	3.6E-04												
Manganese	1.43E-05	N/A	8.3E-06	1.63E-06		1E-01		1.63E-06		1E-01		1.02E-08		7E-04	
Thallium	N/A	N/A	9.5E-09												
Vanadium	N/A	N/A	3.3E-07												
Total Hazard Quotient and Cancer Risk:						1E-01	1E-07			1E-01	5E-09			9E-04	1E-10
				Assumptions for Industrial Worker			Assumptions for Construction Worker			Assumptions for Adolescent Trespasser					
				CA =	EPC Stockpile	CA =	EPC Stockpile	CA =	EPC Stockpile	CA =	EPC Stockpile	CA =	EPC Stockpile	CA =	EPC Stockpile
				BW =	70 kg	BW =	70 kg	BW =	50 kg	BW =	50 kg	BW =	50 kg	BW =	50 kg
				IR =	20 m3/day	IR =	20 m3/day	IR =	1.6 m3/day	IR =	1.6 m3/day	IR =	1.6 m3/day	IR =	1.6 m3/day
				EF =	250 days/year	EF =	250 days/year	EF =	14 days/year	EF =	14 days/year	EF =	14 days/year	EF =	14 days/year
				ED =	25 years	ED =	1 year	ED =	5 years	ED =	5 years	ED =	5 years	ED =	5 years
				AT (Nc) =	9,125 days	AT (Nc) =	365 days	AT (Nc) =	1,825 days	AT (Nc) =	1,825 days	AT (Nc) =	1,825 days	AT (Nc) =	1,825 days
				AT (Car) =	25,550 days	AT (Car) =	25,550 days	AT (Car) =	25,550 days	AT (Car) =	25,550 days	AT (Car) =	25,550 days	AT (Car) =	25,550 days

Note: Cells in this table were intentionally left blank due to a lack of toxicity data.
NA= Information not available.

**TABLE G-7C
CALCULATION OF INTAKE AND RISK FROM INHALATION OF DUST IN AMBIENT AIR
REASONABLE MAXIMUM EXPOSURE (RME) - SEAD-71 (FENCED AREA EXCLUDED)
SEAD-59 AND SEAD-71 PHASE II RI
Seneca Army Depot Activity**

Equation for Intake (mg/kg-day) = $\frac{EPC \times IR \times EF \times ED}{BW \times AT}$	Equation for Hazard Quotient = Chronic Daily Intake (Nc)/Reference Dose
Variables (Assumptions for Each Receptor are Listed at the Bottom): EPC = Exposure Point Concentration in Air, mg/m ³ IR = Inhalation Rate EF = Exposure Frequency	Equation for Cancer Risk = Chronic Daily Intake (Car) x Slope Factor
ED = Exposure Duration BW = Bodyweight AT = Averaging Time	

Analyte	Inhalation RID (mg/kg-day)	Carc. Slope Inhalation (mg/kg-day)-1	Air EPC from Surface Soil (mg/m ³)	Air EPC from Total Soils (mg/m ³)	Industrial Worker			Construction Worker			Adolescent Trespasser					
					Intake (mg/kg-day)		Hazard Quotient	Cancer Risk	Intake (mg/kg-day)		Hazard Quotient	Cancer Risk	Intake (mg/kg-day)		Hazard Quotient	Cancer Risk
					(Nc)	(Car)			(Nc)	(Car)			(Nc)	(Car)		
2-Methylnaphthalene	N/A	N/A	#N/A	1.8E-07												
Benzo(a)anthracene	N/A	N/A	4.9E-08	5.2E-06												
Benzo(a)pyrene	N/A	3.10E+00	4.6E-08	3.6E-06		3.21E-09		1E-08		1.01E-08		3E-08		4.02E-12	1E-11	
Benzo(b)fluoranthene	N/A	N/A	2.7E-08	2.1E-06												
Benzo(k)fluoranthene	N/A	N/A	4.1E-08	2.9E-06												
Chrysene	N/A	N/A	3.2E-08	2.5E-06												
Dibenz(a,h)anthracene	N/A	N/A	1.2E-08	1.4E-06												
Indeno(1,2,3-cd)pyrene	N/A	N/A	2.9E-08	2.1E-06												
Naphthalene	8.57E-04	N/A	3.1E-09	1.8E-07	6.15E-10		7E-07		3.45E-08		4E-05		3.86E-12		5E-09	
Aluminum	1.43E-03	N/A	2.1E-04	1.2E-02	4.04E-05		3E-02		2.27E-03		2E+00		2.54E-07		2E-04	
Antimony	N/A	N/A	2.7E-08	1.5E-06												
Arsenic	N/A	1.51E+01	1.1E-07	5.8E-06		7.49E-09		1E-07		1.63E-08		2E-07		9.39E-12	1E-10	
Iron	N/A	N/A	4.1E-04	2.3E-02												
Manganese	1.43E-05	N/A	9.3E-06	5.1E-04	1.82E-06		1E-01		1.01E-04		7E+00		1.14E-08		8E-04	
Thallium	N/A	N/A	4.9E-09	2.8E-07												
Vanadium	N/A	N/A	3.3E-07	1.8E-05												
Total Hazard Quotient and Cancer Risk:							2E-01	1E-07			9E+00	3E-07		1E-03	2E-10	
					Assumptions for Industrial Worker			Assumptions for Construction Worker			Assumptions for Adolescent Trespasser					
					CA =	EPC Surface Only		CA =	EPC Surface and Sub-Surface		CA =	EPC Surface Only				
					BW =	70 kg		BW =	70 kg		BW =	50 kg				
					IR =	20 m ³ /day		IR =	20 m ³ /day		IR =	1.6 m ³ /day				
					EF =	250 days/year		EF =	250 days/year		EF =	14 days/year				
					ED =	25 years		ED =	1 year		ED =	5 years				
					AT (Nc) =	9,125 days		AT (Nc) =	365 days		AT (Nc) =	1,825 days				
					AT (Car) =	25,550 days		AT (Car) =	25,550 days		AT (Car) =	25,550 days				

Note: Cells in this table were intentionally left blank due to a lack of toxicity data.
NA= Information not available.

**TABLE G-8A
CALCULATION OF ABSORBED DOSE AND RISK FROM DERMAL CONTACT TO GROUNDWATER
REASONABLE MAXIMUM EXPOSURE (RME) - SEAD-59
SEAD-59 AND SEAD-71 PHASE II RI
Seneca Army Depot Activity**

Equation for Dermal (mg/kg-day) = $\frac{DA \times SA \times EF \times ED \times EV}{BW \times AT}$	Equation for Absorbed Dose per Event (DA): For inorganics: $DA = K_p \times EPC \times t_{event} \times CF$	
Variables (Assumptions for Each Receptor are Listed at the Bottom): DA = Absorbed Dose per Event, mg/cm ² -event SA = Surface Area Contact EF = Exposure Frequency EV = Event Frequency	K_p = Permeability Coefficient, cm/hr EPC = EPC in Groundwater, mg/L CF = Conversion Factor, 10 ⁻³ L/cm ³	Equation for Hazard Quotient = Chronic Daily Intake (Nc)/Reference Dose Equation for Cancer Risk = Chronic Daily Intake (Car) x Slope Factor
ED = Exposure Duration BW = Bodyweight AT = Averaging Time		

Analyte	Dermal RfD (mg/kg-day)	Carc. Slope Dermal (mg/kg-day) ⁻¹	Permeability Coefficient K_p (cm/hr)	t_{event} (hr/event)	EPC Ground Water (mg/L)	Absorbed Dose/Event (mg/cm ² -event)	Industrial Worker			Construction Worker			Adolescent Trespasser						
							Intake (mg/kg-day)		Hazard Quotient	Cancer Risk	Intake (mg/kg-day)		Hazard Quotient	Cancer Risk	Intake (mg/kg-day)		Hazard Quotient	Cancer Risk	
							(Nc)	(Car)			(Nc)	(Car)			(Nc)	(Car)			
Metals							Dermal Contact to Ground Water Not Applicable for Industrial Worker						Dermal Contact to Ground Water Not Applicable for Adolescent Trespasser						
Antimony	4.E-04	N/A	1.E-03	5.E-01	9.E-03	4.30E-09				4.19E-08						1E-04			
Arsenic	3.E-04	1.5E+00	1.E-03	5.E-01	2.E-03	1.00E-09				9.75E-09	1.39E-10					3E-05	2E-10		
Iron	3.E-01	N/A	1.E-03	5.E-01	4.E+00	1.97E-06				1.92E-05						6E-05			
Manganese	2.E-02	N/A	1.E-03	5.E-01	8.E-01	3.90E-07				3.80E-06						2E-04			
Thallium	6.E-04	N/A	1.E-03	5.E-01	4.E-03	2.00E-09				1.95E-08						3E-05			
Vanadium	1.E-03	N/A	1.E-03	5.E-01	5.E-03	2.63E-09				2.56E-08						3E-05			
Total Hazard Quotient and Cancer Risk:										4E-04	2E-10								
							Assumptions for Construction Worker BW = 70 kg SA = 2,490 cm ² EV = 1 event/day EF = 100 days/year ED = 1 years t_{event} = 0.5 hr/event AT (Nc) = 365 days AT (Car) = 25,550 days												

Note: Cells in this table were intentionally left blank due to a lack of toxicity data
NA= Information not available

**TABLE G-8B
CALCULATION OF ABSORBED DOSE AND RISK FROM DERMAL CONTACT TO GROUNDWATER
REASONABLE MAXIMUM EXPOSURE (RME) - SEAD-71 EXCLUDE FENCED AREA
SEAD-59 AND SEAD-71 PHASE II RI
Seneca Army Depot Activity**

Equation for Dermal (mg/kg-day) = $\frac{DA \times SA \times EF \times ED \times EV}{BW \times AT}$	Equation for Absorbed Dose per Event (DA): For inorganics: $DA = K_p \times EPC \times t_{event} \times C$ For organics: If $t_{event} \leq t^*$, then: $DA_{event} = 2 FA \times K_p \times C_w \left(\frac{6 \tau_{event} \times t_{event}}{\pi} \right)^{1/2}$ If $t_{event} > t^*$, then: $DA_{event} = FA \times K_p \times C_w \left[\left(\frac{t_{event}}{1+B} \right) + 2 \tau_{event} \left(\frac{1+3B+3B^2}{(1+B)^2} \right) \right]$	Equation for Hazard Quotient = Chronic Daily Intake (Nc)/Reference Dose Equation for Cancer Risk = Chronic Daily Intake (Car) x Slope Factor
Variables (Assumptions for Each Receptor are Listed at the Bottom): DA = Absorbed Dose per Event SA = Surface Area Contact EF = Exposure Frequency EV = Event Frequency ED = Exposure Duration BW = Bodyweight AT = Averaging Time	K_p = Permeability Coefficient, cm/hr EPC = EPC in Groundwater, mg/L C = Conversion Factor, 10^3 L/cm ³ t^* = Dimensionless ratio of the permeability coefficient of a compound through the stratum corneum relative to its permeability coefficient across the viable epidermis (ve) (dimensionless) FA = Fraction absorbed water (dimensionless)	

Analyte	Dermal RfD (mg/kg-day)	Carc. Slope Dermal (mg/kg-day) ⁻¹	Permeability Coefficient K_p (cm/hr)	τ_{event} (hr/event)	Fraction Absorbed Water	B	t^* (hour)	EPC Ground Water (mg/L)	Absorbed Dose/Event (mg-cm ³ /event)	Industrial Worker			Construction Worker			Adolescent Trespasser							
										Intake (mg/kg-day)		Hazard Quotient	Cancer Risk	Intake (mg/kg-day)		Hazard Quotient	Cancer Risk	Intake (mg/kg-day)		Hazard Quotient	Cancer Risk		
										(Nc)	(Car)			(Nc)	(Car)			(Nc)	(Car)				
Semivolatile Organic 4-nitroaniline	3.E-03	2.0E-02	2.7E-03	0.6	1.0	1.3E-02	3.0E-02	2.0E+01	8.1E-05	Dermal Contact to Ground Water Not Applicable for Industrial Worker			7.87E-04	1.12E-05	3E-01	2E-07	Dermal Contact to Ground Water Not Applicable for Adolescent Trespasser						
Metals Aluminum	1.E+00	N/A	1.0E-03					2.7E-03	1.4E-09				1.32E-08			1E-08							
Antimony	6.E-05	N/A	1.0E-03					2.7E-03	1.4E-09				1.32E-08			2E-04							
Arsenic	3.E-04	1.5E+00	1.0E-03					6.5E-03	3.3E-09				3.18E-08	4.54E-10						1E-04	7E-10		
Chromium	8.E-05	N/A	1.0E-03					2.7E-03	1.4E-09				1.32E-08			2E-04							
Iron	3.E-01	N/A	1.0E-03					2.7E-03	1.4E-09				1.32E-08			4E-08							
Manganese	9.E-04	N/A	1.0E-03					3.5E+01	1.8E-05				1.71E-04			2E-01							
Thallium	6.E-04	N/A	1.0E-03					1.7E-02	8.6E-09				8.38E-08			1E-04							
Vanadium	3.E-05	N/A	1.0E-03					1.7E-02	8.6E-09				8.38E-08			3E-03							
Total Hazard Quotient and Cancer Risk:															4E-01	7E-10							
															Assumptions for Construction Worker								
												BW =	70 kg										
												SA =	2,490 cm ²										
												EV =	1 event/day										
												EF =	100 days/year										
												ED =	1 years										
												t_{event} =	0.5 hr/event										
												AT (Nc) =	365 days										
												AT (Car) =	25,550 days										

Note: Cells in this table were intentionally left blank due to a lack of toxicity data
NA= Information not available.

TABLE G-9A
CALCULATION OF INTAKE AND RISK FROM THE INTAKE OF GROUNDWATER
REASONABLE MAXIMUM EXPOSURE (RME) - SEAD-59
SEAD-59 AND SEAD-71 PHASE II RI
Seneca Army Depot Activity

Equation for Intake (mg/kg-day) = $\frac{EPC \times IR \times EF \times ED}{BW \times AT}$	Equation for Hazard Quotient = Chronic Daily Intake (Nc)/Reference Dose
Variables (Assumptions for Each Receptor are Listed at the Bottom): EPC = Exposure Point Concentration in Groundwater (mg/L) ED=Exposure Duration IR = Intake Rate BW=Bodyweight EF = Exposure Frequency AT=Averaging Time	Equation for Cancer Risk = Chronic Daily Intake (Car) x Slope Factor

Analyte	Oral RfD (mg/kg-day)	Carc. Slope Oral (mg/kg-day)-1	EPC Groundwater (mg/liter)	Industrial Worker				Construction Worker				Adolescent Trespasser			
				Intake (mg/kg-day)		Hazard Quotient	Cancer Risk	Intake (mg/kg-day)		Hazard Quotient	Cancer Risk	Intake (mg/kg-day)		Hazard Quotient	Cancer Risk
				(Nc)	(Car)			(Nc)	(Car)			(Nc)	(Car)		
Antimony	4.E-04	N/A	0.0086	8.4E-05	3.0E-05	2E-01		8.4E-05	1.2E-06	2E-01		1.3E-05	9.4E-07	3E-02	
Arsenic	3.E-04	1.5E+00	0.002	2.0E-05	7.0E-06	7E-02	1E-05	2.0E-05	2.8E-07	7E-02	4E-07	3.1E-06	2.2E-07	1E-02	3E-07
Iron	3.E-01	N/A	3.94	3.9E-02	1.4E-02	1E-01		3.9E-02	5.5E-04	1E-01		6.0E-03	4.3E-04	2E-02	
Manganese	2.E-02	N/A	0.78	7.6E-03	2.7E-03	3E-01		7.6E-03	1.1E-04	3E-01		1.2E-03	8.5E-05	5E-02	
Thallium	6.E-04	N/A	0.004	3.9E-05	1.4E-05	6E-02		3.9E-05	5.6E-07	6E-02		6.1E-06	4.4E-07	9E-03	
Vanadium	1.E-03	N/A	0.00526	5.1E-05	1.8E-05	5E-02		5.1E-05	7.4E-07	5E-02		8.1E-06	5.8E-07	8E-03	
Total Hazard Quotient and Cancer Risk:						8E-01	1E-05			8E-01	4E-07			1E-01	3E-07
				Assumptions for Industrial Worker				Assumptions for Construction Worker				Assumptions for Adolescent Trespasser			
				BW = 70 kg				BW = 70 kg				BW = 50 kg			
				IR = 1 liters/day				IR = 1 liters/day				IR = 2.0 liters/day			
				EF = 250 days/year				EF = 250 days/year				EF = 14 days/year			
				ED = 25 years				ED = 1 years				ED = 5 years			
				AT (Nc) = 9,125 days				AT (Nc) = 365 days				AT (Nc) = 1,825 days			
				AT (Car) = 25,550 days				AT (Car) = 25,550 days				AT (Car) = 25,550 days			

Note: Cells in this table were intentionally left blank due to a lack of toxicity data.

N/A= Information not available.

TABLE G-9B
CALCULATION OF INTAKE AND RISK FROM THE INTAKE OF GROUNDWATER
REASONABLE MAXIMUM EXPOSURE (RME) - SEAD-71 (FENCED AREA EXCLUDED)
SEAD-59 AND SEAD-71 PHASE II RI
Seneca Army Depot Activity

Equation for Intake (mg/kg-day) = $\frac{EPC \times IR \times EF \times ED}{BW \times AT}$	Equation for Hazard Quotient = Chronic Daily Intake (Nc)/Reference Dose
Variables (Assumptions for Each Receptor are Listed at the Bottom): EPC = Exposure Point Concentration in Groundwater, mg/L IR = Ingestion Rate EF = Exposure Frequency	Equation for Cancer Risk = Chronic Daily Intake (Car) x Slope Factor
ED=Exposure Duration BW=Bodyweight AT=Averaging Time	

Analyte	Oral RfD (mg/kg-day)	Carc. Slope Oral (mg/kg-day) ⁻¹	EPC Groundwater (mg/liter)	Industrial Worker				Construction Worker				Adolescent Trespasser			
				Intake (mg/kg-day)		Hazard Quotient	Cancer Risk	Intake (mg/kg-day)		Hazard Quotient	Cancer Risk	Intake (mg/kg-day)		Hazard Quotient	Cancer Risk
				(Nc)	(Car)			(Nc)	(Car)			(Nc)	(Car)		
4-Nitroaniline	3.E-03	2.0E-02	0.0087	8.51E-05	3.04E-05	3E-02	6E-07	8.51E-05	1.22E-06	3E-02	2E-08	1.33E-05	9.53E-07	4.45E-03	1.91E-08
Aluminum	1.E+00	N/A	19.7	1.93E-01	6.88E-02	2E-01		1.93E-01	2.75E-03	2E-01		3.02E-02	2.16E-03	3.02E-02	
Antimony	4.E-04	N/A	0.00652	6.38E-05	2.28E-05	2E-01		6.38E-05	9.11E-07	2E-01		1.00E-05	7.15E-07	2.50E-02	
Arsenic	3.E-04	1.5E+00	0.0027	2.64E-05	9.44E-06	9E-02	1E-05	2.64E-05	3.77E-07	9E-02	6E-07	4.14E-06	2.96E-07	1.38E-02	4.44E-07
Chromium	3.E-03	N/A	0.0331	3.24E-04	1.16E-04	1E-01		3.24E-04	4.63E-06	1E-01		5.08E-05	3.63E-06	1.69E-02	
Iron	3.E-01	N/A	35.1	3.43E-01	1.23E-01	1E+00		3.43E-01	4.91E-03	1E+00		5.39E-02	3.85E-03	1.80E-01	
Manganese	2.E-02	N/A	2.68	2.62E-02	9.37E-03	1E+00		2.62E-02	3.75E-04	1E+00		4.11E-03	2.94E-04	1.76E-01	
Thallium	6.E-04	N/A	0.0025	2.45E-05	8.74E-06	4E-02		2.45E-05	3.49E-07	4E-02		3.84E-06	2.74E-07	5.93E-03	
Vanadium	1.E-03	N/A	0.0257	2.51E-04	8.98E-05	3E-01		2.51E-04	3.59E-06	3E-01		3.94E-05	2.82E-06	3.94E-02	
Total Hazard Quotient and Cancer Risk:						3E+00	1E-05			3E+00	6E-07			5E-01	5E-07
				Assumptions for Industrial Worker				Assumptions for Construction Worker				Assumptions for Adolescent Trespasser			
				BW = 70 kg				BW = 70 kg				BW = 50 kg			
				IR = 1 liters/day				IR = 1 liters/day				IR = 2 liters/day			
				EF = 250 days/year				EF = 250 days/year				EF = 14 days/year			
				ED = 25 years				ED = 1 years				ED = 5 years			
				AT (Nc) = 9,125 days				AT (Nc) = 365 days				AT (Nc) = 1,825 days			
				AT (Car) = 25,550 days				AT (Car) = 25,550 days				AT (Car) = 25,550 days			

Note: Cells in this table were intentionally left blank due to a lack of toxicity data.
NA= Information not available.

Appendix H

Human Health Risk Assessment Uncertainty Analysis Background Comparison Analysis

- H-1A Comparison Between Aluminum Concentrations in SEAD-59 Soil and Seneca Background – Student’s T Test
- H-1B Comparison Between Aluminum Concentrations in SEAD-59 Soil and Seneca Background – Mann-Whitney Test
- H-2A Comparison Between Manganese Concentrations in SEAD-59 Soil and Seneca Background – Student’s T Test
- H-2B Comparison Between Manganese Concentrations in SEAD-59 Soil and Seneca Background – Mann-Whitney Test
- H-3A Comparison Between Aluminum Concentrations in SEAD-71 Soil Outside Fenced Area and Seneca Background – Student’s T Test
- H-3B Comparison Between Aluminum Concentrations in SEAD-71 Soil Outside Fenced Area and Seneca Background – Mann-Whitney Test
- H-4A Comparison Between Manganese Concentrations in SEAD-71 Soil Outside Fenced Area and Seneca Background – Student’s T Test
- H-4B Comparison Between Manganese Concentrations in SEAD-71 Soil Outside Fenced Area and Seneca Background – Mann-Whitney Test

**Table H-1A
Comparison Between Aluminum Concentrations in SEAD-59 Soil and Seneca Background - Student's T Test**

XLSTAT 2006 - Two-sample t-test and z-test - on 2/22/2006 at 2:19:22 PM

Sample 1: Workbook = AIMndata.xls / Sheet = Data / Range = Data!\$A\$3:\$A\$201 / 199 rows and 1 column (SEAD-59 Soil)

Sample 2: Workbook = AIMndata.xls / Sheet = Data / Range = Data!\$C\$3:\$C\$56 / 54 rows and 1 column (Seneca Background)

Hypothesized difference (D): 0

Significance level (%): 5

Fisher's F-test / Two-tailed test

Summary statistics:

Variable	Observations	Obs. with missing data	Obs. without missing data	Minimum	Maximum	Mean	Std. deviation
Var1	199	0	199	4200.000	18300.000	10895.452	2462.019
Var1(2)	54	0	54	5560.000	20500.000	13205.741	4158.638

Fisher's F-test / Two-tailed test:

95% confidence interval on the ratio of variances:

] 0.347, 0.347 [

Ratio	0.350
F (Observed value)	7.010
F (Critical value)	1.009
DF1	198
DF2	53
p-value (one-tailed)	< 0.0001
alpha	0.05

Test interpretation:

H0: The difference between the means is not significantly different from 0.

Ha: The difference between the means is significantly lower than 0.

As the computed p-value is lower than the significance level $\alpha=0.05$, one should reject the null hypothesis H0, and accept the alternative hypothesis Ha.

The risk to reject the null hypothesis H0 while it is true is lower than 0.01%.

t-test for two independent samples / Lower-tailed test (assumed different variances for two samples):

95% confidence interval on the difference between the means:

] -Inf , -1321.730 [

Difference	-2310.288
t (Observed value)	-3.901
t (Critical value)	1.669
DF	63
p-value (one-tailed)	0.000
alpha	0.05

The number of degrees of freedom is approximated by the Welch-Satterthwaite formula

The critical t is estimated using the Cochran-Cox approximation

Test interpretation:

H0: The difference between the means is not significantly different from 0.

Ha: The difference between the means is significantly lower than 0.

As the computed p-value is lower than the significance level $\alpha=0.05$, one should reject the null hypothesis H0, and accept the alternative hypothesis Ha.

The risk to reject the null hypothesis H0 while it is true is lower than 0.01%.

**Table H-1B
Comparison Between Aluminum Concentrations in SEAD-59 Soil and Seneca Background - Mann-Whitney Test**

XLSTAT 2006 - Comparison of two samples (Wilcoxon, Mann-Whitney, ...) - on 2/22/2006 at 2:44:53 PM
 Sample 1: Workbook = AIMndata.xls / Sheet = Data / Range = Data!\$A\$3:\$A\$201 / 199 rows and 1 column (SEAD-59 Soil)
 Sample 2: Workbook = AIMndata.xls / Sheet = Data / Range = Data!\$C\$3:\$C\$56 / 54 rows and 1 column (Seneca Background)
 Hypothesized difference (D): 0
 Significance level (%): 5

Summary statistics 

Summary statistics:

Variable	Observations	Obs. with missing data	Obs. without missing data	Minimum	Maximum	Mean	Std. deviation
Var1	199	0	199	4200.000	18300.000	10895.452	2462.019
Var1(2)	54	0	54	5560.000	20500.000	13205.741	4158.638

Mann-Whitney test / Lower-tailed test:

U	3644.500
Expected value	5373.000
Variance (U)	227437.280
p-value (one-tailed)	0.000
alpha	0.05

The exact p-value could not be computed. An approximation has been used to compute the p-value.

Test interpretation:

H0: The location difference between the samples is not significantly different from 0.

Ha: The location difference between the samples is significantly lower than 0.

As the computed p-value is lower than the significance level $\alpha=0.05$, one should reject the null hypothesis H0, and accept the alternative hypothesis Ha.

The risk to reject the null hypothesis H0 while it is true is lower than 0.01%.

Ties have been detected in the data and the appropriate corrections have been applied.

Table H-2A
Comparison Between Manganese Concentrations in SEAD-59 Soil and Seneca Background - Student's T Test

XLSTAT 2006 - Two-sample t-test and z-test - on 2/22/2006 at 3:16:58 PM

Sample 1: Workbook = AIMndata.xls / Sheet = Data / Range = Data!\$E\$3:\$E\$201 / 199 rows and 1 column (SEAD-59 Soil)

Sample 2: Workbook = AIMndata.xls / Sheet = Data / Range = Data!\$G\$3:\$G\$53 / 51 rows and 1 column (Seneca Background)

Hypothesized difference (D): 0

Significance level (%): 5

Summary statistics

Summary statistics:

Variable	Observations	Obs. with missing data	Obs. without missing data	Minimum	Maximum	Mean	Std. deviation
Var1	199	0	199	156.000	1290.000	503.405	200.614
Var1(2)	51	0	51	207.000	2380.000	609.069	334.524

Fisher's F-test / Two-tailed test:

95% confidence interval on the ratio of variances:

] 0.356, 0.356 [

Ratio	0.360
F (Observed value)	7.193
F (Critical value)	1.010
DF1	198
DF2	50
p-value (one-tailed)	< 0.0001
alpha	0.05

Test interpretation:

H0: The difference between the means is not significantly different from 0.

Ha: The difference between the means is significantly lower than 0.

As the computed p-value is lower than the significance level alpha=0.05, one should reject the null hypothesis H0, and accept the alternative hypothesis Ha.

The risk to reject the null hypothesis H0 while it is true is lower than 0.01%.

t-test for two independent samples / Lower-tailed test (assumed different variance for two samples):

95% confidence interval on the difference between the means:

] -Inf , -23.869 [

Difference	-105.664
t (Observed value)	-2.158
t (Critical value)	1.671
DF	60
p-value (one-tailed)	0.017
alpha	0.05

The number of degrees of freedom is approximated by the Welch-Satterthwaite formula

The critical t is estimated using the Cochran-Cox approximation

Test interpretation:

H0: The difference between the means is not significantly different from 0.

Ha: The difference between the means is significantly lower than 0.

As the computed p-value is lower than the significance level alpha=0.05, one should reject the null hypothesis H0, and accept the alternative hypothesis Ha.

The risk to reject the null hypothesis H0 while it is true is lower than 1.75%.

Table H-2B

Comparison Between Manganese Concentrations in SEAD-59 Soil and Seneca Background - Mann-Whitney

XLSTAT 2006 - Comparison of two samples (Wilcoxon, Mann-Whitney, ...) - on 4/13/2006 at 1:26:41 PM

Sample 1: Workbook = AlMndata.xls / Sheet = Data / Range = Data!\$E\$3:\$E\$201 / 199 rows and 1 column (SEAD-59 Soil)

Sample 2: Workbook = AlMndata.xls / Sheet = Data / Range = Data!\$G\$3:\$G\$53 / 51 rows and 1 column (Seneca Background)

Hypothesized difference (D): 0

Significance level (%): 5

Continuity correction: Yes

Summary statistics

Summary statistics:

Variable	Observations	Obs. with missing data	Obs. without missing data	Minimum	Maximum	Mean	Std. deviation
Var1	199	0	199	156.000	1290.000	503.405	200.614
Var1(2)	51	0	51	207.000	2380.000	609.069	334.524

Mann-Whitney test / Lower-tailed test:

U	4016.500
Expected value	5074.500
Variance (U)	212278.522
p-value (one-tailed)	0.011
alpha	0.05

The exact p-value could not be computed. An approximation has been used to compute the p-value.

Test interpretation:

H0: The location difference between the samples is not significantly different from 0.

Ha: The location difference between the samples is significantly lower than 0.

As the computed p-value is lower than the significance level $\alpha=0.05$, one should reject the null hypothesis H0, and accept the alternative hypothesis Ha.

The risk to reject the null hypothesis H0 while it is true is lower than 1.09%.

Ties have been detected in the data and the appropriate corrections have been applied.

Table H-3A

Comparison Between Aluminum Concentrations in SEAD-71 Soil Outside Fenced Area and Seneca Background - Student's T Test

XLSTAT 2006 - Two-sample t-test and z-test - on 2/22/2006 at 2:55:01 PM

Sample 1: Workbook = AIMndata.xls / Sheet = Data / Range = Data!\$B\$3:\$B\$64 / 62 rows and 1 column (SEAD-71 Soil Outside Fenced Area)

Sample 2: Workbook = AIMndata.xls / Sheet = Data / Range = Data!\$C\$3:\$C\$56 / 54 rows and 1 column (Seneca Background)

Hypothesized difference (D): 0

Significance level (%): 5

Summary statistics

Summary statistics:

Variable	Observations	Obs. with missing data	Obs. without missing data	Minimum	Maximum	Mean	Std. deviation
Var1	62	0	62	6120.000	15900.000	11492.903	2374.855
Var1(2)	54	0	54	5560.000	20500.000	13205.741	4158.638

Fisher's F-test / Two-tailed test:

95% confidence interval on the ratio of variances:
] 0.326, 0.326 [

Ratio	0.326
F (Observed value)	6.522
F (Critical value)	1.002
DF1	61
DF2	53
p-value (one-tailed)	< 0.0001
alpha	0.05

Test interpretation:

H0: The difference between the means is not significantly different from 0.

Ha: The difference between the means is significantly lower than 0.

As the computed p-value is lower than the significance level alpha=0.05, one should reject the null hypothesis H0, and accept the alternative hypothesis Ha.

The risk to reject the null hypothesis H0 while it is true is lower than 0.01%.

t-test for two independent samples / Lower-tailed test (assumed different variance for two samples):

95% confidence interval on the difference between the means:
] -Inf, -645.934 [

Difference	-1712.838
t (Observed value)	-2.671
t (Critical value)	1.664
DF	82
p-value (one-tailed)	0.005
alpha	0.05

The number of degrees of freedom is approximated by the Welch-Satterthwaite formula

The critical t is estimated using the Cochran-Cox approximation

Test interpretation:

H0: The difference between the means is not significantly different from 0.

Ha: The difference between the means is significantly lower than 0.

As the computed p-value is lower than the significance level alpha=0.05, one should reject the null hypothesis H0, and accept the alternative hypothesis Ha.

The risk to reject the null hypothesis H0 while it is true is lower than 0.46%.

H-3B

Comparison Between Aluminum Concentrations in SEAD-71 Soil Outside Fenced Area and Seneca Background - Mann-Whitney Test

XLSTAT 2006 - Comparison of two samples (Wilcoxon, Mann-Whitney, ...) - on 2/22/2006 at 3:33:50 PM

Sample 1: Workbook = AIMndata.xls / Sheet = Data / Range = Data!\$B\$3:\$B\$64 / 62 rows and 1 column (SEAD-71 Soil Outside Fenced Area)

Sample 2: Workbook = AIMndata.xls / Sheet = Data / Range = Data!\$C\$3:\$C\$56 / 54 rows and 1 column (SEAD-71 Soil Outside Fenced Area)

Hypothesized difference (D): 0

Significance level (%): 5

Summary statistics ▼

Summary statistics:

Variable	Observations	Obs. with missing data	Obs. without missing data	Minimum	Maximum	Mean	Std. deviation
Var1	62	0	62	6120.000	15900.000	11492.903	2374.855
Var1(2)	54	0	54	5560.000	20500.000	13205.741	4158.638

Mann-Whitney test / Two-tailed test:

U	1258.500
Expected value	1674.000
Variance (U)	32640.867
p-value (Two-tailed)	0.022
alpha	0.05

The exact p-value could not be computed. An approximation has been used to compute the p-value.

Test interpretation:

H0: The location difference between the samples is not significantly different from 0.

Ha: The location difference between the samples is significantly different from 0.

As the computed p-value is lower than the significance level $\alpha=0.05$, one should reject the null hypothesis H0, and accept the alternative hypothesis Ha.

The risk to reject the null hypothesis H0 while it is true is lower than 2.16%.

Ties have been detected in the data and the appropriate corrections have been applied.

Table H-4A

Comparison Between Manganese Concentrations in SEAD-71 Soil Outside Fenced Area and Seneca Background - Student's T Test

XLSTAT 2006 - Two-sample t-test and z-test - on 2/22/2006 at 3:22:53 PM

Sample 1: Workbook = AIMndata.xls / Sheet = Data / Range = Data!\$F\$3:\$F\$64 / 62 rows and 1 column (SEAD-71 Soil Outside Fenced Area)

Sample 2: Workbook = AIMndata.xls / Sheet = Data / Range = Data!\$G\$3:\$G\$53 / 51 rows and 1 column (Seneca Background)

Hypothesized difference (D): 0

Significance level (%): 5

Summary statistics

Summary statistics:

Variable	Observations	Obs. with missing data	Obs. without missing data	Minimum	Maximum	Mean	Std. deviation
Var1	62	0	62	296.000	1330.000	569.548	172.625
Var1(2)	51	0	51	207.000	2380.000	609.069	334.524

Fisher's F-test / Two-tailed test:

95% confidence interval on the ratio of variances:

] 0.266, 0.266 [

Ratio	0.266
F (Observed value)	5.326
F (Critical value)	1.002
DF1	61
DF2	50
p-value (one-tailed)	< 0.0001
alpha	0.05

Test interpretation:

H0: The difference between the means is not significantly different from 0.

Ha: The difference between the means is significantly lower than 0.

As the computed p-value is lower than the significance level alpha=0.05, one should reject the null hypothesis H0, and accept the alternative hypothesis Ha.

The risk to reject the null hypothesis H0 while it is true is lower than 0.01%.

t-test for two independent samples / Lower-tailed test (assumed different variances for two samples):

95% confidence interval on the difference between the means:

] -Inf, 46.667 [

Difference	-39.520
t (Observed value)	-0.764
t (Critical value)	1.666
DF	71
p-value (one-tailed)	0.224
alpha	0.05

The number of degrees of freedom is approximated by the Welch-Satterthwaite formula

The critical t is estimated using the Cochran-Cox approximation

Test interpretation:

H0: The difference between the means is not significantly different from 0.

Ha: The difference between the means is significantly lower than 0.

As the computed p-value is greater than the significance level alpha=0.05, one should accept the null hypothesis H0.

The risk to reject the null hypothesis H0 while it is true is 22.37%.

Table H-4B

Comparison Between Manganese Concentrations in SEAD-71 Soil Outside Fenced Area and Seneca Background - Mann-Whitney Test

XLSTAT 2006 - Comparison of two samples (Wilcoxon, Mann-Whitney, ...) - on 2/22/2006 at 3:28:14 PM

Sample 1: Workbook = AIMndata.xls / Sheet = Data / Range = Data!\$F\$3:\$F\$64 / 62 rows and 1 column (SEAD-71 Soil Outside Fenced Area)

Sample 2: Workbook = AIMndata.xls / Sheet = Data / Range = Data!\$G\$3:\$G\$53 / 51 rows and 1 column (Seneca Background)

Hypothesized difference (D): 0

Significance level (%): 5

Summary statistics

Summary statistics:

Variable	Observations	Obs. with missing data	Obs. without missing data	Minimum	Maximum	Mean	Std. deviation
Var1	62	0	62	296.000	1330.000	569.548	172.625
Var1(2)	51	0	51	207.000	2380.000	609.069	334.524

Mann-Whitney test / Two-tailed test:

U	1666.500
Expected value	1581.000
Variance (U)	30039.000
p-value (Two-tailed)	0.624
alpha	0.05

The exact p-value could not be computed. An approximation has been used to compute the p-value.

Test interpretation:

H0: The location difference between the samples is not significantly different from 0.

Ha: The location difference between the samples is significantly different from 0.

As the computed p-value is greater than the significance level alpha=0.05, one should accept the null hypothesis H0.

The risk to reject the null hypothesis H0 while it is true is 62.38%.

Ties have been detected in the data and the appropriate corrections have been applied.

Appendix I

Human Health Risk Calculation Tables for SEAD-59 Stockpile Soil Exposure Under Residential Scenario

- I-1A Exposure Factor Assumptions for Residential Child
- I-1B Exposure Factor Assumptions for Residential Adult
- I-2A Calculation of Intake and Risk from the Ingestion of SEAD-59 Stockpile Soil for Residential Receptors – RME
- I-2B Calculation of Intake and Risk from the Ingestion of SEAD-59 Stockpile Soil for Residential Receptors – CT
- I-3A Calculation of Absorbed Dose and Risk from Dermal Contact to SEAD-59 Stockpile Soil for Residential Receptors – RME
- I-3B Calculation of Absorbed Dose and Risk from Dermal Contact to SEAD-59 Stockpile Soil for Residential Receptors – CT
- I-4A Calculation of Intake and Risk from Inhalation of Dust in Ambient Air from SEAD-59 Stockpile Soil for Residential Receptors – RME
- I-4B Calculation of Intake and Risk from Inhalation of Dust in Ambient Air from SEAD-59 Stockpile Soil for Residential Receptors – CT
- I-5A Calculation of Intake and Risk from Dermal Contact to SEAD-59 Groundwater (While Showering) for Residential Receptors – RME
- I-5B Calculation of Intake and Risk from Dermal Contact to SEAD-59 Groundwater (While Showering) for Residential Receptors – CT
- I-6A Calculation of Intake and Risk from Intake of SEAD-59 Groundwater for Residential Receptors – RME
- I-6B Calculation of Intake and Risk from Intake of SEAD-59 Groundwater for Residential Receptors – CT

TABLE I-1A
EXPOSURE FACTOR ASSUMPTIONS FOR RESIDENTIAL CHILD
SEAD-59/71 PHASE II RI
Seneca Army Depot Activity

Scenario Timeframe:	Future
Medium:	Soil
Exposure Medium:	Soil
Exposure Point:	SEAD-59 Stockpile
Receptor Population:	Residential Child
Receptor Age:	Child (0-6 yr)

EXPOSURE ROUTE	PARAMETER CODE	PARAMETER DEFINITION	UNITS	RME VALUE	RME RATIONALE	RME REFERENCE	CT VALUE	CT RATIONALE	CT REFERENCE
Ingestion of Soil	EPC	Soil EPC	mg/kg	Table G-2F	See Table G-2F	See Table G-2F.	Table G-2F	See Table G-2F	Table G-2F.
	BW	Body Weight	kg	15	Default value for child (ages 0-6yr).	USEPA, 2002.	15	Default value for child.	USEPA, 2002.
	IR	Ingestion Rate	mg/day	200	Default soil ingestion rate for child.	USEPA, 2002.	100	Mean soil ingestion rate for child.	USEPA, 1997.
	FI	Fraction Ingested	unitless	1	Assuming 100% ingestion from site.	BPJ.	1	Assuming 100% ingestion from site.	BPJ.
	EF	Exposure Frequency	days/yr	350	Default exposure frequency for residential receptor.	USEPA, 2004, 2002. USEPA, 2002.	350	Default exposure frequency for residential receptor.	USEPA, 2002, 2004.
	ED	Exposure Duration	year	6	Default exposure duration.		6	Default exposure duration.	USEPA, 2002.
	CF	Conversion Factor	kg/mg	1E-6			1E-6		
	AT(Nc) AT(Cair)	Averaging Time - Nc Averaging Time - Car	days days	2,190 25,550	6 years. 70 years, default value for human life span.	USEPA, 2002.	2,190 25,550	6 years. 70 years, default value for human life span.	USEPA, 2002.
Dermal Contact of Soil	EPC	Soil EPC	mg/kg	Table G-2F	See Table G-2F	See Table G-2F.	Table G-2F	See Table G-2F	Table G-2F.
	BW	Body Weight	kg	15	Default value for child.	USEPA, 2002.	15	Default value for child.	USEPA, 2002.
	SA	Skin Contact Surface Area	cm ²	2,800	Default value for child.	USEPA, 2002, 2004.	2,800	Default value for child.	USEPA, 2004.
	AF	Soil/Skin Adherence Factor	mg/cm ² -event	0.2	Default RME value for child.	USEPA, 2002, 2004.	0.04	Default CT value for child.	USEPA, 2004.
	ABS	Dermal Absorption Fraction	unitless		Chemical-specific	USEPA, 2004.		Chemical-specific	USEPA, 2004.
	EV	Event Frequency	events/day	1	Default value for residential child.	USEPA, 2004, 2002.	1	Default value for residential child.	USEPA, 2004
	EF	Exposure Frequency	days/yr	350	Default exposure frequency for residential receptor.	USEPA, 2004, 2002.	350	Default exposure frequency for residential receptor.	USEPA, 2002, 2004.
	ED CF AT(Nc) AT(Cair)	Exposure Duration Conversion Factor Averaging Time - Nc Averaging Time - Car	year kg/mg days days	6 1E-6 2,190 25,550	Default exposure duration. 6 year. 70 years, default value for human life span.	USEPA, 2002. USEPA, 2002.	6 1E-6 2,190 25,550	Default exposure duration. 6 years. 70 years, default value for human life span.	USEPA, 2002. USEPA, 2002.

Source References:

- Notes:
- BPJ: Best Professional Judgment.
 - USEPA, 1997: Exposure Factors Handbook
 - USEPA, 2002: Supplemental Guidance For Developing Soil Screening Levels For Superfund Sites. December.
 - USEPA, 2004: Risk Assessment Guidance for Superfund Volume I: Human Health Evaluation Manual (Part E, Supplemental Guidance for Dermal Risk Assessment) Final.

Intake Equations:

Ingestion Daily Intake (DI) (mg/kg-day) = EPC x IR x EF x ED x CF x FI / (BW x AT)
Dermal DI (mg/kg-day) = EPC x SA x AF x ABS x EV x EF x ED x CF/(BW x AT)

**TABLE I-1A
EXPOSURE FACTOR ASSUMPTIONS FOR RESIDENTIAL CHILD
SEAD-59/71 PHASE II RI
Seneca Army Depot Activity**

Scenario Timeframe:	Future
Medium:	Groundwater
Exposure Medium:	Groundwater
Exposure Point:	SEAD-59
Receptor Population:	Residential Child
Receptor Age:	Child (0-6 yr)

EXPOSURE ROUTE	PARAMETER CODE	PARAMETER DEFINITION	UNITS	RME VALUE	RME RATIONALE	RME REFERENCE	CT VALUE	CT RATIONALE	CT REFERENCE
Intake of Groundwater	EPC	Groundwater EPC	mg/L	Table G-2E	See Table G-2E.	See Table G-2E	Table G-2E	See Table G-2E.	Table G-2E.
	BW	Body Weight	kg	15	Default value for child (ages 0-6r).	USEPA, 2002.	15	Default value for child ages (0-6yr).	USEPA, 2002.
	IR	Intake Rate	L/day	1.5	95th percentile for children ages 1-10 yr.	USEPA, 1997.	0.74	Average for children ages 1-10 yr.	USEPA, 1997.
	EF	Exposure Frequency	days/yr	350	Default exposure frequency for residential receptor.	USEPA, 2004, 2002.	350	Default exposure frequency for residential receptor.	USEPA, 2002.
	ED	Exposure Duration	year	6	Default exposure duration.	USEPA, 2002.	6	Default exposure duration.	USEPA, 2002.
	AT(Nc) AT(Cair)	Averaging Time - Nc Averaging Time - Car	days days	2,190 25,550	6 years. 70 years, default value for human life span.	USEPA, 2002.	2,190 25,550	6 years. 70 years, default value for human life span.	USEPA, 2002.
Dermal Contact of Groundwater	EPC	Groundwater EPC	mg/L	Table G-2E	See Table ?.	See Table G-2E	Table G-2E	See Table G-2E.	Table G-2E.
	Kp	Permeability Constant	cm/hr		Chemical-specific.	USEPA, 2004.		Chemical-specific.	USEPA, 2004.
	BW	Body Weight	kg	15	Default value for child (ages 0-6r).	USEPA, 2002.	15	Default value for child ages (0-6yr).	USEPA, 2002.
	SA	Skin Contact Surface Area	cm ²	6,600	Default RME for child showering/bathing.	USEPA, 2004.	6,600	Default CT for child showering/bathing.	USEPA, 2004.
	EV	Event Frequency	events/day	1	Default RME for child showering/bathing.	USEPA, 2004.	1	Default CT for child showering/bathing.	USEPA, 2004.
	t _{event}	Event Duration	hr/event	1.0	Default RME for child showering/bathing.	USEPA, 2004.	0.33	Default CT for child showering/bathing.	USEPA, 2004.
	EF	Exposure Frequency	days/yr	350	Default exposure frequency for residential receptor.	USEPA, 2004, 2002.	350	Default exposure frequency for residential receptor.	USEPA, 2002, 2004.
	ED	Exposure Duration	year	6	Default exposure duration.	USEPA, 2002.	6	Default exposure duration.	USEPA, 2002.
	AT(Nc) AT(Cair)	Averaging Time - Nc Averaging Time - Car	days days	2,190 25,550	6 years. 70 years, default value for human life span.	USEPA, 2002.	2,190 25,550	6 years. 70 years, default value for human life span.	USEPA, 2002.

Source References:

- USEPA, 1997: Exposure Factors Handbook
- USEPA, 2002: Supplemental Guidance For Developing Soil Screening Levels For Superfund Sites. December.
- USEPA, 2004: Risk Assessment Guidance for Superfund Volume I: Human Health Evaluation Manual (Part E, Supplemental Guidance for Dermal Risk Assessment) Final.

Notes:

RME = Reasonable Maximum Exposure
CT = Central Tendency Exposure

Intake Equations:

Intake Daily Intake (DI) (mg/kg-day) = EPC x IR x EF x ED/(BW x AT)

Dermal DI (mg/kg-day) = DA_{event} x EV x EF x ED x SA/(BW x AT)

Equation for Absorbed Dose per Event (DA_{event}):

For inorganics: DA_{event} = Kp x EPC x t_{event} x C

Where:
Kp = Permeability Coefficient, cm/hr
EPC = EPC in Groundwater, mg/L
C = Conversion Factor, 10⁻³ L/cm³

For organics:

If t_{event} <= t*, then: DA_{event} = 2 FA x K_p x C_w ((6 t_{event} x t_{event}) / π)^{1/2}

if t_{event} > t*, then: DA_{event} = FA x K_p x C_w [(t_{event} / 1 + B) + 2 t_{event} ((1 + 3 B + 3 B²) / (1 + B)²)]

Where:
B = Dimensionless ratio of the permeability coefficient of a compound through the stratum corneum relative to its permeability coefficient across the viable epidermis (ve) (dimensionless)
FA = Fraction absorbed water (dimensionless)

**TABLE I-1A
EXPOSURE FACTOR ASSUMPTIONS FOR RESIDENTIAL CHILD
SEAD-59/71 PHASE II RI
Seneca Army Depot Activity**

Scenario Timeframe:	Future
Medium:	Soil
Exposure Medium:	Air
Exposure Point:	SEAD-59 Stockpile
Receptor Population:	Residential Child
Receptor Age:	Child (0-6 yr)

EXPOSURE ROUTE	PARAMETER CODE	PARAMETER DEFINITION	UNITS	RME VALUE	RME RATIONALE	RME REFERENCE	CT VALUE	CT RATIONALE	CT REFERENCE
Inhalation of Dust in Ambient Air	EPC	Air EPC	mg/m ³	Table G-2G	See Table G-2G	Table G-2G.	Table G-2G	See Table G-2G	See Table G-2G.
	BW	Body Weight	kg	15	Default value for child (ages 0-6yr).	USEPA, 2002.	15	Default value for child ages 0-6yr.	USEPA, 2002.
	IR	Inhalation Rate	m ³ /day	7.1	Average long term inhalation rate for child ages 0-6 yr.	USEPA, 1997.	7.1	Average long term inhalation rate for child ages 0-6.	USEPA, 1997.
	EF	Exposure Frequency	days/yr	350	Default exposure frequency for residential child.	USEPA, 2004, 2002.	350	Default value for residential child.	USEPA, 2002, 2004.
AT(Nc) AT(Cair)	ED	Exposure Duration	year	6	Default value for exposure duration.	USEPA, 2002.	6	Default value for exposure duration.	USEPA, 2002.
		Averaging Time - Nc	days	2,190	6 years.		2,190	6 years.	
		Averaging Time - Car	days	25,550	70 years, default value for human life span.	USEPA, 2002.	25,550	70 years, default value for human life span.	USEPA, 2002.

Source References:

- USEPA, 1997: Exposure Factors Handbook
- USEPA, 2002: Supplemental Guidance For Developing Soil Screening Levels For Superfund Sites. December.
- USEPA, 2004: Risk Assessment Guidance for Superfund Volume I: Human Health Evaluation Manual (Part E, Supplemental Guidance for Dermal Risk Assessment) Final.

Notes:

RME = Reasonable Maximum Exposure
CT = Central Tendency Exposure

Intake Equation:

Inhalation Daily Intake (DI) (mg/kg-day) = EPC x IR x EF x ED / (BW x AT)

**TABLE I-1B
EXPOSURE FACTOR ASSUMPTIONS FOR RESIDENTIAL ADULT
SEAD-59/71 PHASE II RI
Seneca Army Depot Activity**

Scenario Timeframe:	Future
Medium:	Soil
Exposure Medium:	Soil
Exposure Point:	SEAD-59 Stockpile
Receptor Population:	Residential Adult
Receptor Age:	Adult

EXPOSURE ROUTE	PARAMETER CODE	PARAMETER DEFINITION	UNITS	RME VALUE	RME RATIONALE	RME REFERENCE	CT VALUE	CT RATIONALE	CT REFERENCE
Ingestion of Soil	EPC	Soil EPC	mg/kg	Table G-2F	See Table G-2F	See Table G-2F.	Table G-2F	See Table G-2F	See Table G-2F.
	BW	Body Weight	kg	70	Default value for adult.	USEPA, 2002.	70	Default value for adult.	USEPA, 2002.
	IR	Ingestion Rate	mg/day	100	Default soil ingestion rate for residential adult.	USEPA, 2002.	50	Central estimate of adult soil ingestion.	USEPA, 1997.
	FI	Fraction Ingested	unitless	1	Assuming 100% ingestion from site.	BPJ.	1	Assuming 100% ingestion from site.	BPJ.
	EF	Exposure Frequency	days/yr	350	Default exposure frequency for residential receptor.	USEPA, 2004, 2002.	350	Default exposure frequency for residential receptor.	USEPA, 2002, 2004.
	ED	Exposure Duration	year	24	Default RME exposure duration.	USEPA, 2002.	9	Default CT exposure duration.	USEPA, 2004.
	CF	Conversion Factor	kg/mg	1E-6			1E-6		
AT(Nc)	Averaging Time - Nc	days	8,760	24 years.		3,285	9 years.		
	AT(Cair)	Averaging Time - Car	days	25,550	70 years, default value for human life span.	USEPA, 2002.	25,550	70 years, default value for human life span.	USEPA, 2002.
Dermal Contact of Soil	EPC	Soil EPC	mg/kg	Table G-2F	See Table G-2F.	See Table G-2F.	Table G-2F	See Table G-2F	See Table G-2F.
	BW	Body Weight	kg	70	Default value for adult.	USEPA, 2002.	70	Default value for adult.	USEPA, 2002.
	SA	Skin Contact Surface Area	cm ²	5,700	Default value for adult.	USEPA, 2004.	5,700	Default value for adult.	USEPA, 2004.
	AF	Soil/Skin Adherence Factor	mg/cm ² -event	0.07	Default RME for adult.	USEPA, 2004.	0.01	Default CT value for adult.	USEPA, 2004.
	ABS	Dermal Absorption Fraction	unitless		Chemical-specific	USEPA, 2004.		Chemical-specific	USEPA, 2004.
	EV	Event Frequency	events/day	1	Default value for residential receptor.	USEPA, 2004.	1	Default value for residential receptor.	USEPA, 2004.
	EF	Exposure Frequency	days/yr	350	Default exposure frequency for residential receptor.	USEPA, 2004, 2002.	350	Default exposure frequency for residential receptor.	USEPA, 2004, 2002.
	ED	Exposure Duration	year	24	Default RME exposure duration.	USEPA, 2004.	9	Default CT exposure duration.	USEPA, 2004.
	CF	Conversion Factor	kg/mg	1E-6			1E-6		
	AT(Nc)	Averaging Time - Nc	days	8,760	24 years.		3,285	9 years.	
AT(Cair)		Averaging Time - Car	days	25,550	70 years, default value for human life span.	USEPA, 2002.	25,550	70 years, default value for human life span.	USEPA, 2002.

Source References:

- BPJ: Best Professional Judgment.
- USEPA, 1997: Exposure Factors Handbook
- USEPA, 2002: Supplemental Guidance For Developing Soil Screening Levels For Superfund Sites. December.
- USEPA, 2004: Risk Assessment Guidance for Superfund Volume I: Human Health Evaluation Manual (Part E, Supplemental Guidance for Dermal Risk Assessment) Final.

Intake Equations:

Ingestion Daily Intake (DI) (mg/kg-day) = EPC x IR x EF x ED x CF x FI / (BW x AT)
Dermal DI (mg/kg-day) = EPC x SA x AF x ABS x EV x EF x ED x CF/(BW x AT)

**TABLE I-1B
EXPOSURE FACTOR ASSUMPTIONS FOR RESIDENTIAL ADULT
SEAD-59/71 PHASE II RI
Seneca Army Depot Activity**

Scenario Timeframe:	Future
Medium:	Groundwater
Exposure Medium:	Groundwater
Exposure Point:	SEAD-59
Receptor Population:	Residential Adult
Receptor Age:	Adult

EXPOSURE ROUTE	PARAMETER CODE	PARAMETER DEFINITION	UNITS	RME VALUE	RME RATIONALE	RME REFERENCE	CT VALUE	CT RATIONALE	CT REFERENCE
Intake of Groundwater	EPC	Groundwater EPC	mg/L	Table G-2E	See Table G-2E.	See Table G-2E	Table G-2E	See Table G-2E.	Table G-2E.
	BW	Body Weight	kg	70	Default value for adult.	USEPA, 2002.	70	Default value for adult.	USEPA, 2002.
	IR	Intake Rate	L/day	2	Default value for adult.	USEPA, 2002.	1.41	Recommended average tapwater intake.	USEPA, 1997.
	EF	Exposure Frequency	days/yr	350	Default exposure frequency for residential receptor.	USEPA, 2004, 2002.	350	Default exposure frequency for residential receptor.	USEPA, 2004, 2002.
	ED	Exposure Duration	year	24	Default RME exposure duration.	USEPA, 2002.	9	Default CT exposure duration.	USEPA, 2002.
	AT(Nc) AT(Cair)	Averaging Time - Nc Averaging Time - Car	days days	8,760 25,550	24 years. 70 years, default value for human life span.	USEPA, 2002.	3,285 25,550	9 years. 70 years, default value for human life span.	USEPA, 2002.
Dermal Contact of Groundwater	EPC	Groundwater EPC	mg/L	Table G-2E	See Table G-2E.	See Table G-2E	Table G-2E	See Table G-2E.	Table G-2E.
	Kp	Permeability Constant	cm/hr		Chemical-specific.	USEPA, 2004.		Chemical-specific.	USEPA, 2004.
	BW	Body Weight	kg	70	Default value for adult.	USEPA, 2002.	70	Default value for adult.	USEPA, 2002.
	SA	Skin Contact Surface Area	cm ²	18,000	Default RME for adult showering/bathing.	USEPA, 2004.	18,000	Default CT for adult showering/bathing.	USEPA, 2004.
	EV	Event Frequency	events/day	1	Default RME for adult showering/bathing.	USEPA, 2004.	1	Default CT for adult showering/bathing.	USEPA, 2004.
	t _{event}	Event Duration	hr/event	0.58	Default RME for adult showering/bathing.	USEPA, 2004.	0.25	Default CT for adult showering/bathing.	USEPA, 2004.
	EF	Exposure Frequency	days/yr	350	Default exposure frequency for residential receptor.	USEPA, 2004, 2002.	350	Default exposure frequency for residential receptor.	USEPA, 2004, 2002.
	ED	Exposure Duration	year	24	Default RME exposure duration.	USEPA, 2002.	9	Default CT exposure duration.	USEPA, 2002.
	AT(Nc) AT(Cair)	Averaging Time - Nc Averaging Time - Car	days days	8,760 25,550	24 years. 70 years, default value for human life span.	USEPA, 2002.	3,285 25,550	9 years. 70 years, default value for human life span.	USEPA, 2002.

Source References:

- USEPA, 1997: Exposure Factors Handbook
- USEPA, 2002: Supplemental Guidance For Developing Soil Screening Levels For Superfund Sites. December.
- USEPA, 2004: Risk Assessment Guidance for Superfund Volume I: Human Health Evaluation Manual (Part E, Supplemental Guidance for Dermal Risk Assessment) Final.

Notes:

RME = Reasonable Maximum Exposure
CT = Central Tendency Exposure

Intake Equations:

Intake Daily Intake (DI) (mg/kg-day) = EPC x IR x EF x ED/(BW x AT)

Dermal DI (mg/kg-day) = DA_{event} x EV x EF x ED x SA/(BW x AT)

Equation for Absorbed Dose per Event (DA_{event}):

For inorganics: DA_{event} = Kp x EPC x t_{event} x C

Where:
Kp = Permeability Coefficient, cm/hr
EPC = EPC in Groundwater, mg/L
C = Conversion Factor, 10⁻³ L/cm³

For organics:

If t_{event} <= t*, then: DA_{event} = 2 FA x K_p x C_w ((6 t_{event} x t_{event}) / π)^{1/2}

if t_{event} > t*, then: DA_{event} = FA x K_p x C_w [(t_{event} / 1 + B) + 2 t_{event} ((1 + 3 B + 3 B²) / (1 + B)²)]

B = Dimensionless ratio of the permeability coefficient of a compound through the stratum corneum relative to its permeability coefficient across the viable epidermis (ve) (dimensionless)
FA = Fraction absorbed water (dimensionless)

**TABLE I-1B
EXPOSURE FACTOR ASSUMPTIONS FOR RESIDENTIAL ADULT
SEAD-59/71 PHASE II RI
Seneca Army Depot Activity**

Scenario Timeframe:	Future
Medium:	Soil
Exposure Medium:	Air
Exposure Point:	SEAD-59 Stockpile
Receptor Population:	Residential Adult
Receptor Age:	Adult

EXPOSURE ROUTE	PARAMETER CODE	PARAMETER DEFINITION	UNITS	RME VALUE	RME RATIONALE	RME REFERENCE	CT VALUE	CT RATIONALE	CT REFERENCE
Inhalation of Dust in Ambient Air	EPC	Air EPC	mg/m ³	Table G-2G	See Table G-2G	See Table G-2G.	Table G-2G	See Table G-2G	See Table G-2G.
	BW	Body Weight	kg	70	Default value for adult.	USEPA, 2002.	70	Default value for adult.	USEPA, 2002.
	IR	Inhalation Rate	m ³ /day	20	Default value for adult.	USEPA, 1997.	13.25	Average long term exposure for men and women.	USEPA, 1997.
	EF	Exposure Frequency	days/yr	350	Default exposure frequency for residential receptor.	USEPA, 2004, 2002.	350	Default value for residential receptor.	USEPA, 2002, 2004.
	ED	Exposure Duration	year	24	Default RME exposure duration.	USEPA, 2002.	9	Default CT exposure duration.	USEPA, 2004.
	AT(Nc)	Averaging Time - Nc	days	8,760	24 years.		3,285	9 years.	
	AT(Cair)	Averaging Time - Car	days	25,550	70 years, default value for human life span.	USEPA, 2002.	25,550	70 years, default value for human life span.	USEPA, 2002.

Source References:

- USEPA, 1997: Exposure Factors Handbook
- USEPA, 2002: Supplemental Guidance For Developing Soil Screening Levels For Superfund Sites. December.
- USEPA, 2004: Risk Assessment Guidance for Superfund Volume I: Human Health Evaluation Manual (Part E, Supplemental Guidance for Dermal Risk Assessment) Final.

Notes:

RME = Reasonable Maximum Exposure
CT = Central Tendency Exposure

Intake Equation

Inhalation Daily Intake (DI) (mg/kg-day) = EPC x IR x EF x ED / (BW x AT)

TABLE I-2A
CALCULATION OF INTAKE AND RISK FROM THE INGESTION OF SOIL FOR RESIDENTIAL RECEPTORS
REASONABLE MAXIMUM EXPOSURE (RME) - SEAD-59 STOCKPILE SOIL
SEAD-59/71 Phase II RI
Seneca Army Depot Activity

<p>Equation for Intake (mg/kg-day) = $\frac{EPC \times IR \times CF \times FI \times EF \times ED}{BW \times AT}$</p> <p>Variables (Assumptions for Each Receptor are Listed at the Bottom):</p> <p>EPC = Exposure Point Concentration in Soil, mg/kg EF = Exposure Frequency, day/year IR = Ingestion Rate, mg/day ED = Exposure Duration, year CF = Conversion Factor, kg/mg BW = Bodyweight, kg FI = Fraction Ingested, unitless AT = Averaging Time, day</p>	<p style="text-align: center;">Equation for Hazard Quotient = Chronic Daily Intake (Nc)/Reference Dose</p> <p style="text-align: center;">Equation for Cancer Risk = Chronic Daily Intake (Car) x Slope Factor</p> <p style="text-align: center;">Equation for Total Lifetime Cancer Risk = Adult Contribution + Child Contribution</p>
--	---

Analyte	Oral RfD (mg/kg-day)	Carc. Slope Oral (mg/kg-day) ⁻¹	EPC Stockpile Soil (mg/kg)	Resident (Adult)			Resident (Child)			Resident Total Lifetime Cancer Risk		
				Intake (mg/kg-day)		Hazard Quotient	Contribution to Lifetime Cancer Risk	Intake (mg/kg-day)			Hazard Quotient	Contribution to Lifetime Cancer Risk
				(Nc)	(Car)			(Nc)	(Car)			
Benzo(a)anthracene	N/A	7.3E-01	6.8E+00		3.19E-06		2E-06		7.45E-06		5E-06	8E-06
Benzo(a)pyrene	N/A	7.3E+00	7.9E+00		3.71E-06		3E-05		8.66E-06		6E-05	9E-05
Benzo(b)fluoranthene	N/A	7.3E-01	5.1E+00		2.40E-06		2E-06		5.59E-06		4E-06	6E-06
Benzo(k)fluoranthene	N/A	7.3E-02	6.7E+00		3.15E-06		2E-07		7.34E-06		5E-07	8E-07
Chrysene	N/A	7.3E-03	6.8E+00		3.19E-06		2E-08		7.45E-06		5E-08	8E-08
Dibenz(a,h)anthracene	N/A	7.3E+00	1.2E+00		5.64E-07		4E-06		1.32E-06		1E-05	1E-05
Indeno(1,2,3-cd)pyrene	N/A	7.3E-01	3.5E+00		1.64E-06		1E-06		3.84E-06		3E-06	4E-06
Aluminum	1.0E+00	N/A	1.08E+04	1.48E-02		1E-02		1.38E-01		1E-01		
Antimony	4E-04	N/A	6.8E+00	9.32E-06		2E-02		8.69E-05		2E-01		
Arsenic	3E-04	1.5E+00	4.9E+00	6.71E-06	2.30E-06	2E-02	3E-06	6.26E-05	5.37E-06	2E-01	8E-06	1E-05
Iron	3E-01	N/A	2.11E+04	2.90E-02		1E-01		2.70E-01		9E-01		
Manganese	2.3E-02	N/A	4.89E+02	6.70E-04		3E-02		6.25E-03		3E-01		
Thallium	6E-04	N/A	5.6E-01	7.67E-07		1E-03		7.16E-06		1E-02		
Vanadium	1.0E-03	N/A	1.94E+01	2.66E-05		3E-02		2.48E-04		2E-01		
Total Hazard Quotient and Cancer Risk:						2E-01	4E-05			2E+00	9E-05	1E-04
				Assumptions for Resident (Adult)				Assumptions for Resident (Child)				
				CF =	1E-06 kg/mg	CF =	1E-06 kg/mg					
				EPC =	EPC Surface Only	EPC =	EPC Surface Only					
				BW =	70 kg	BW =	15 kg					
				IR =	100 mg/day	IR =	200 mg/day					
				FI =	1 unitless	FI =	1 unitless					
				EF =	350 days/year	EF =	350 days/year					
				ED =	24 years	ED =	6 years					
				AT (Nc) =	8,760 days	AT (Nc) =	2,190 days					
				AT (Car) =	25,550 days	AT (Car) =	25,550 days					

Note: Cells in this table were intentionally left blank due to a lack of toxicity data.
 N/A= Information not available.

TABLE I-2B
CALCULATION OF INTAKE AND RISK FROM THE INGESTION OF SOIL FOR RESIDENTIAL RECEPTORS
CENTRAL TENDENCY (CT) - SEAD-59 STOCKPILE SOIL
SEAD-59/71 Phase II RI
Seneca Army Depot Activity

Equation for Intake (mg/kg-day) =	$\frac{EPC \times IR \times CF \times FI \times EF \times ED}{BW \times AT}$	Equation for Hazard Quotient = Chronic Daily Intake (Nc)/Reference Dose Equation for Cancer Risk = Chronic Daily Intake (Car) x Slope Factor Equation for Total Lifetime Cancer Risk = Adult Contribution + Child Contribution
Variables (Assumptions for Each Receptor are Listed at the Bottom):		
EPC = Exposure Point Concentration in Soil, mg/kg	EF = Exposure Frequency, day/year	
IR = Ingestion Rate, mg/day	ED = Exposure Duration, year	
CF = Conversion Factor, kg/mg	BW = Bodyweight, kg	
FI = Fraction Ingested, unitless	AT = Averaging Time, day	

Analyte	Oral RfD (mg/kg-day)	Carc. Slope Oral (mg/kg-day) ⁻¹	EPC Stockpile Soil (mg/kg)	Resident (Adult)				Resident (Child)			Resident Total Lifetime Cancer Risk	
				Intake (mg/kg-day)		Hazard Quotient	Contribution to Lifetime Cancer Risk	Intake (mg/kg-day)		Hazard Quotient		Contribution to Lifetime Cancer Risk
				(Nc)	(Car)			(Nc)	(Car)			
Benzo(a)anthracene	N/A	7.3E-01	6.8E+00		5.99E-07		4E-07		3.73E-06		3E-06	3E-06
Benzo(a)pyrene	N/A	7.3E+00	7.9E+00		6.96E-07		5E-06		4.33E-06		3E-05	4E-05
Benzo(b)fluoranthene	N/A	7.3E-01	5.1E+00		4.49E-07		3E-07		2.79E-06		2E-06	2E-06
Benzo(k)fluoranthene	N/A	7.3E-02	6.7E+00		5.90E-07		4E-08		3.67E-06		3E-07	3E-07
Chrysene	N/A	7.3E-03	6.8E+00		5.99E-07		4E-09		3.73E-06		3E-08	3E-08
Dibenz(a,h)anthracene	N/A	7.3E+00	1.2E+00		1.06E-07		8E-07		6.58E-07		5E-06	6E-06
Indeno(1,2,3-cd)pyrene	N/A	7.3E-01	3.5E+00		3.08E-07		2E-07		1.92E-06		1E-06	2E-06
Aluminum	1.0E+00	N/A	1.08E+04	7.40E-03		7E-03		6.90E-02		7E-02		
Antimony	4E-04	N/A	6.8E+00	4.66E-06		1E-02		4.35E-05		1E-01		
Arsenic	3E-04	1.5E+00	4.9E+00	3.36E-06	4.32E-07	1E-02	6E-07	3.13E-05	2.68E-06	1E-01	4E-06	5E-06
Iron	3E-01	N/A	2.11E+04	1.45E-02		5E-02		1.35E-01		5E-01		
Manganese	2.3E-02	N/A	4.89E+02	3.35E-04		1E-02		3.13E-03		1E-01		
Thallium	6E-04	N/A	5.6E-01	3.84E-07		6E-04		3.58E-06		6E-03		
Vanadium	1.0E-03	N/A	1.94E+01	1.33E-05		1E-02		1.24E-04		1E-01		
Total Hazard Quotient and Cancer Risk:						1E-01	8E-06			1E+00	5E-05	5E-05
				Assumptions for Resident (Adult)				Assumptions for Resident (Child)				
				CF =	1E-06 kg/mg	CF =	1E-06 kg/mg	EPC =	EPC Surface Only	EPC =	EPC Surface Only	
				BW =	70 kg	BW =	15 kg	BW =	15 kg			
				IR =	50 mg/day	IR =	100 mg/day	IR =	100 mg/day			
				FI =	1 unitless	FI =	1 unitless	FI =	1 unitless			
				EF =	350 days/year	EF =	350 days/year	EF =	350 days/year			
				ED =	9 years	ED =	6 years	ED =	6 years			
				AT (Nc) =	3,285 days	AT (Nc) =	2,190 days	AT (Nc) =	2,190 days			
				AT (Car) =	25,550 days	AT (Car) =	25,550 days	AT (Car) =	25,550 days			

Note: Cells in this table were intentionally left blank due to a lack of toxicity data.
N/A= Information not available.

**TABLE I-3A
CALCULATION OF ABSORBED DOSE AND RISK FROM DERMAL CONTACT TO SOIL FOR RESIDENTIAL RECEPTORS
REASONABLE MAXIMUM EXPOSURE (RME) - SEAD-59 STOCKPILE SOIL**

**SEAD-59/71 Phase II RI
Seneca Army Depot Activity**

Equation for Intake (mg/kg-day) = $\frac{EPC \times CF \times SA \times AF \times ABS \times EV \times EF \times ED}{BW \times AT}$	Equation for Hazard Quotient = Chronic Daily Intake (Nc)/Reference Dose
Variables (Assumptions for Each Receptor are Listed at the Bottom):	Equation for Contribution to Lifetime Cancer Risk = Chronic Daily Intake (Car) x Slope Factor
EPC = Exposure Point Concentration in Soil, mg/kg	Equation for Total Lifetime Cancer Risk = Adult Contribution + Child Contribution
CF = Conversion Factor, kg/mg	
SA = Surface Contact Area, cm ²	
AF = Adherence Factor, mg/cm ² -event	
ABS = Absorption Factor, unitless	
EV = Event Frequency, event/day	
EF = Exposure Frequency, day/year	
ED = Exposure Duration, year	
BW = Bodyweight, kg	
AT = Averaging Time, day	

Analyte	Dermal RfD (mg/kg-day)	Carc. Slope Dermal (mg/kg-day)-1	Absorption Factor* (unitless)	EPC Stockpile Soil (mg/kg)	Resident (Adult)			Resident (Child)			Resident Total Lifetime Cancer Risk		
					Intake (mg/kg-day)		Hazard Quotient	Contribution to Lifetime Cancer Risk	Intake (mg/kg-day)			Hazard Quotient	Contribution to Lifetime Cancer Risk
					(Nc)	(Car)			(Nc)	(Car)			
Benzo(a)anthracene	N/A	7.3E-01	1.3E-01	6.8E+00		1.66E-06		1E-06		2.71E-06		2E-06	3E-06
Benzo(a)pyrene	N/A	7.3E+00	1.3E-01	7.9E+00		1.92E-06		1E-05		3.15E-06		2E-05	4E-05
Benzo(b)fluoranthene	N/A	7.3E-01	1.3E-01	5.1E+00		1.24E-06		9E-07		2.03E-06		1E-06	2E-06
Benzo(k)fluoranthene	N/A	7.3E-02	1.3E-01	6.7E+00		1.63E-06		1E-07		2.67E-06		2E-07	3E-07
Chrysene	N/A	7.3E-03	1.3E-01	6.8E+00		1.66E-06		1E-08		2.71E-06		2E-08	3E-08
Dibenz(a,h)anthracene	N/A	7.3E+00	1.3E-01	1.2E+00		2.92E-07		2E-06		4.79E-07		3E-06	6E-06
Indeno(1,2,3-cd)pyrene	N/A	7.3E-01	1.3E-01	3.5E+00		8.53E-07		6E-07		1.40E-06		1E-06	2E-06
Aluminum	1.0E+00	N/A	1E-03	1.08E+04	5.90E-05		6E-05		3.87E-04	4E-04			
Antimony	6E-05	N/A	1E-03	6.8E+00	3.72E-08		6E-04		2.43E-07	4E-03			
Arsenic	3E-04	1.5E+00	3E-02	4.9E+00	8.03E-07	2.75E-07	3E-03	4E-07	5.26E-06	4.51E-07	2E-02	7E-07	1E-06
Iron	3E-01	N/A	1E-03	2.11E+04	1.16E-04		4E-04		7.57E-04	3E-03			
Manganese	9E-04	N/A	1E-03	4.89E+02	2.67E-06		3E-03		1.75E-05	2E-02			
Thallium	6E-04	N/A	1E-03	5.6E-01	3.06E-09		5E-06		2.00E-08	3E-05			
Vanadium	3E-05	N/A	1E-03	1.94E+01	1.06E-07		4E-03		6.95E-07	3E-02			
Total Hazard Quotient and Cancer Risk:							1E-02	2E-05		7E-02	3E-05	5E-05	
					Assumptions for Resident (Adult)			Assumptions for Resident (Child)					
					CF =	1E-06 kg/mg	CF =	1E-06 kg/mg					
					BW =	70 kg	BW =	15 kg					
					SA =	5,700 cm ²	SA =	2,800 cm ²					
					AF =	0.07 mg/cm ² -event	AF =	0.2 mg/cm ² -event					
					EV =	1 event/day	EV =	1 event/day					
					EF =	350 days/year	EF =	350 days/year					
					ED =	24 years	ED =	6 years					
					AT (Nc) =	8,760 days	AT (Nc) =	2,190 days					
					AT (Car) =	25,550 days	AT (Car) =	25,550 days					

Note: Cells in this table were intentionally left blank due to a lack of toxicity data.

N/A= Information not available.

Absorption factors from Exhibit 3-4 of USEPA (2004) Supplemental Guidance for Dermal Risk Assessment, Part E of Risk Assessment Guidance for Superfund, Human Health Evaluation Manual (Volume I).

Absorption factors for metals other than arsenic were assumed to be 0.001 in accordance with the USEPA Region 4 (2000)

Supplemental Guidance to RAGS: Region 4 Bulletins, Human Health Risk Assessment Bulletins (<http://www.epa.gov/region4/waste/ots/healthbul.htm>).

TABLE I-3B
CALCULATION OF ABSORBED DOSE AND RISK FROM DERMAL CONTACT TO SOIL FOR RESIDENTIAL RECEPTORS
CENTRAL TENDENCY (CT) - SEAD-59 STOCKPILE SOIL
SEAD-59/71 Phase II RI
Seneca Army Depot Activity

Equation for Intake (mg/kg-day) = $\frac{EPC \times CF \times SA \times AF \times ABS \times EV \times EF \times ED}{BW \times AT}$	Equation for Hazard Quotient = Chronic Daily Intake (Nc)/Reference Dose
Variables (Assumptions for Each Receptor are Listed at the Bottom):	Equation for Contribution to Lifetime Cancer Risk = Chronic Daily Intake (Car) x Slope Factor
EPC = Exposure Point Concentration in Soil, mg/kg	Equation for Total Lifetime Cancer Risk = Adult Contribution + Child Contribution
CF = Conversion Factor, kg/mg	
SA = Surface Contact Area, cm ²	
AF = Adherence Factor, mg/cm ² -event	
ABS = Absorption Factor, unitless	
EV = Event Frequency, event/day	
EF = Exposure Frequency, day/year	
ED = Exposure Duration, year	
BW = Bodyweight, kg	
AT = Averaging Time, day	

Analyte	Dermal RfD (mg/kg-day)	Carc. Slope Dermal (mg/kg-day)-1	Absorption Factor* (unitless)	EPC Stockpile Soil (mg/kg)	Resident (Adult)			Resident (Child)			Resident Total Lifetime Cancer Risk		
					Intake (mg/kg-day)		Hazard Quotient	Contribution to Lifetime Cancer Risk	Intake (mg/kg-day)			Hazard Quotient	Contribution to Lifetime Cancer Risk
					(Nc)	(Car)			(Nc)	(Car)			
Benzo(a)anthracene	N/A	7.3E-01	1.3E-01	6.8E+00		8.87E-08		6E-08		5.43E-07		4E-07	5E-07
Benzo(a)pyrene	N/A	7.3E+00	1.3E-01	7.9E+00		1.03E-07		8E-07		6.30E-07		5E-06	5E-06
Benzo(b)fluoranthene	N/A	7.3E-01	1.3E-01	5.1E+00		6.66E-08		5E-08		4.07E-07		3E-07	3E-07
Benzo(k)fluoranthene	N/A	7.3E-02	1.3E-01	6.7E+00		8.74E-08		6E-09		5.35E-07		4E-08	5E-08
Chrysene	N/A	7.3E-03	1.3E-01	6.8E+00		8.87E-08		6E-10		5.43E-07		4E-09	5E-09
Dibenz(a,h)anthracene	N/A	7.3E+00	1.3E-01	1.2E+00		1.57E-08		1E-07		9.57E-08		7E-07	8E-07
Indeno(1,2,3-cd)pyrene	N/A	7.3E-01	1.3E-01	3.5E+00		4.57E-08		3E-08		2.79E-07		2E-07	2E-07
Aluminum	1.0E+00	N/A	1E-03	1.08E+04	8.43E-06		8E-06		7.73E-05		8E-05		
Antimony	6E-05	N/A	1E-03	6.8E+00	5.31E-09		9E-05		4.87E-08		8E-04		
Arsenic	3E-04	1.5E+00	3E-02	4.9E+00	1.15E-07	1.48E-08	4E-04	2E-08	1.05E-06	9.02E-08	4E-03	1E-07	2E-07
Iron	3E-01	N/A	1E-03	2.11E+04	1.65E-05		6E-05		1.51E-04		5E-04		
Manganese	9E-04	N/A	1E-03	4.89E+02	3.82E-07		4E-04		3.50E-06		4E-03		
Thallium	6E-04	N/A	1E-03	5.6E-01	4.37E-10		7E-07		4.01E-09		6E-06		
Vanadium	3E-05	N/A	1E-03	1.94E+01	1.51E-08		6E-04		1.39E-07		5E-03		
Total Hazard Quotient and Cancer Risk:							2E-03	1E-06			1E-02	6E-06	7E-06
					Assumptions for Resident (Adult)			Assumptions for Resident (Child)					
					CF =	1E-06 kg/mg	CF =	1E-06 kg/mg					
					BW =	70 kg	BW =	15 kg					
					SA =	5,700 cm ²	SA =	2,800 cm ²					
					AF =	0.01 mg/cm ² -event	AF =	0.04 mg/cm ² -event					
					EV =	1 event/day	EV =	1 event/day					
					EF =	350 days/year	EF =	350 days/year					
					ED =	9 years	ED =	6 years					
					AT (Nc) =	3,285 days	AT (Nc) =	2,190 days					
					AT (Car) =	25,550 days	AT (Car) =	25,550 days					

Note: Cells in this table were intentionally left blank due to a lack of toxicity data.

N/A= Information not available.

Absorption factors from Exhibit 3-4 of USEPA (2004) Supplemental Guidance for Dermal Risk Assessment, Part E of Risk Assessment Guidance for Superfund, Human Health Evaluation Manual (Volume I).

Absorption factors for metals other than arsenic were assumed to be 0.001 in accordance with the USEPA Region 4 (2000)

Supplemental Guidance to RAGS: Region 4 Bulletins, Human Health Risk Assessment Bulletins (<http://www.epa.gov/region4/waste/ots/healthbul.htm>).

TABLE I-4A
CALCULATION OF INTAKE AND RISK FROM INHALATION OF DUST IN AMBIENT AIR FOR RESIDENTIAL RECEPTORS
REASONABLE MAXIMUM EXPOSURE (RME) - SEAD-59 STOCKPILE SOIL
SEAD-59/71 Phase II RI
Seneca Army Depot Activity

Equation for Intake (mg/kg-day) = $\frac{CA \times IR \times EF \times ED}{BW \times AT}$	Equation for Hazard Quotient = Chronic Daily Intake (Nc)/Reference Dose
Variables (Assumptions for Each Receptor are Listed at the Bottom): CA = Chemical Concentration in Air from Stockpile Soil, mg/m ³ ED = Exposure Duration, year IR = Inhalation Rate, m ³ /day BW = Bodyweight, kg EF = Exposure Frequency, day/year AT = Averaging Time, day	Equation for Cancer Risk = Chronic Daily Intake (Car) x Slope Factor

Analyte	Inhalation RfD (mg/kg-day)	Carc. Slope Inhalation (mg/kg-day) ⁻¹	Air EPC from Stockpile Soil (mg/m ³)	Resident (Adult)			Resident (Child)			Resident Total Lifetime Cancer Risk		
				Intake (mg/kg-day)		Hazard Quotient	Contribution to Lifetime Cancer Risk	Intake (mg/kg-day)			Hazard Quotient	Contribution to Lifetime Cancer Risk
				(Nc)	(Car)			(Nc)	(Car)			
Benzo(a)anthracene	N/A	N/A	1.2E-07									
Benzo(a)pyrene	N/A	3.1E+00	1.3E-07		1.26E-08		4E-08	5.22E-09		2E-08	6E-08	
Benzo(b)fluoranthene	N/A	N/A	8.7E-08									
Benzo(k)fluoranthene	N/A	N/A	1.1E-07									
Chrysene	N/A	N/A	1.2E-07									
Dibenz(a,h)anthracene	N/A	N/A	2.0E-08									
Indeno(1,2,3-cd)pyrene	N/A	N/A	6.0E-08									
Aluminum	1.43E-03	N/A	1.8E-04	5.03E-05		4E-02		8.33E-05	6E-02			
Antimony	N/A	N/A	1.2E-07									
Arsenic	N/A	1.5E+01	8.3E-08		7.82E-09		1E-07	3.24E-09		5E-08	2E-07	
Iron	N/A	N/A	3.6E-04									
Manganese	1E-05	N/A	8.3E-06	2.28E-06		2E-01		3.77E-06	3E-01			
Thallium	N/A	N/A	9.5E-09									
Vanadium	N/A	N/A	3.3E-07									
Total Hazard Quotient and Cancer Risk:						2E-01	2E-07		3E-01	6E-08	2E-07	
				Assumptions for Resident (Adult)			Assumptions for Resident (Child)					
				CA =	Air EPC from Stockpile Soil		CA =	Air EPC from Stockpile Soil				
				BW =	70 kg		BW =	15 kg				
				IR =	20 m ³ /day		IR =	7.1 m ³ /day				
				EF =	350 days/year		EF =	350 days/year				
				ED =	24 years		ED =	6 years				
				AT (Nc) =	8,760 days		AT (Nc) =	2,190 days				
				AT (Car) =	25,550 days		AT (Car) =	25,550 days				

Note: Cells in this table were intentionally left blank due to a lack of toxicity data.
 N/A= Information not available.

TABLE I-4B
CALCULATION OF INTAKE AND RISK FROM INHALATION OF DUST IN AMBIENT AIR FOR RESIDENTIAL RECEPTORS
CENTRAL TENDENCY (CT) - SEAD-59 STOCKPILE SOIL
SEAD-59/71 Phase II RI
Seneca Army Depot Activity

Equation for Intake (mg/kg-day) = $\frac{CA \times IR \times EF \times ED}{BW \times AT}$	Equation for Hazard Quotient = Chronic Daily Intake (Nc)/Reference Dose
Variables (Assumptions for Each Receptor are Listed at the Bottom): CA = Chemical Concentration in Air from Stockpile Soil, mg/m ³ ED = Exposure Duration, year IR = Inhalation Rate, m ³ /day BW = Bodyweight, kg EF = Exposure Frequency, day/year AT = Averaging Time, day	Equation for Cancer Risk = Chronic Daily Intake (Car) x Slope Factor

Analyte	Inhalation RfD (mg/kg-day)	Carc. Slope Inhalation (mg/kg-day) ¹	Air EPC from Stockpile Soil (mg/m3)	Resident (Adult)			Resident (Child)			Resident Total Lifetime Cancer Risk		
				Intake (mg/kg-day)		Hazard Quotient	Contribution to Lifetime Cancer Risk	Intake (mg/kg-day)			Hazard Quotient	Contribution to Lifetime Cancer Risk
				(Nc)	(Car)			(Nc)	(Car)			
Benzo(a)anthracene	N/A	N/A	1.2E-07									
Benzo(a)pyrene	N/A	3.1E+00	1.3E-07		3.13E-09		1E-08		5.22E-09	2E-08	3E-08	
Benzo(b)fluoranthene	N/A	N/A	8.7E-08									
Benzo(k)fluoranthene	N/A	N/A	1.1E-07									
Chrysene	N/A	N/A	1.2E-07									
Dibenz(a,h)anthracene	N/A	N/A	2.0E-08									
Indeno(1,2,3-cd)pyrene	N/A	N/A	6.0E-08									
Aluminum	1.43E-03	N/A	1.8E-04	3.33E-05		2E-02		8.33E-05		6E-02		
Antimony	N/A	N/A	1.2E-07									
Arsenic	N/A	1.5E+01	8.3E-08		1.94E-09		3E-08		3.24E-09		5E-08	
Iron	N/A	N/A	3.6E-04									
Manganese	1E-05	N/A	8.3E-06	1.51E-06		1E-01		3.77E-06		3E-01		
Thallium	N/A	N/A	9.5E-09									
Vanadium	N/A	N/A	3.3E-07									
Total Hazard Quotient and Cancer Risk:						1E-01	4E-08			3E-01	6E-08	1E-07
				Assumptions for Resident (Adult)			Assumptions for Resident (Child)					
				CA =	Air EPC from Stockpile Soil			CA =	Air EPC from Stockpile Soil			
				BW =	70 kg			BW =	15 kg			
				IR =	13.25 m3/day			IR =	7.1 m3/day			
				EF =	350 days/year			EF =	350 days/year			
				ED =	9 years			ED =	6 years			
				AT (Nc) =	3,285 days			AT (Nc) =	2,190 days			
				AT (Car) =	25,550 days			AT (Car) =	25,550 days			

Note: Cells in this table were intentionally left blank due to a lack of toxicity data.

N/A= Information not available.

TABLE I-5A
CALCULATION OF INTAKE AND RISK FROM DERMAL CONTACT TO GROUNDWATER (WHILE SHOWERING) FOR RESIDENTIAL RECEPTORS
REASONABLE MAXIMUM EXPOSURE (RME)
SEAD-59/71 Phase II RI
Seneca Army Depot Activity

<p>Equation for Intake (mg/kg-day) = $\frac{DA_{event} \times SA \times EF \times ED \times EV}{BW \times AT}$</p> <p><u>Variables (Assumptions for Each Receptor are Listed at the Bottom):</u></p> <p>DA_{event} = Absorbed Dose per Event (mg/event-cm²)</p> <p>SA = Surface Area Contact (cm²)</p> <p>EF = Exposure Frequency (day/year)</p> <p>ED = Exposure Duration (year)</p> <p>EV = Event Frequency (event/day)</p> <p>BW = Body Weight (kg)</p> <p>AT = Averaging Time (day)</p>	<p>Equation for Absorbed Dose per Event (DA):</p> <p>For inorganics: $DA_{event} = Kp \times EPC \times t_{event} \times CF$</p> <p>EPC = Exposure Point Concentration (mg/L)</p> <p>t_{event} = Event Duration (hr/event)</p> <p>CF = Conversion Factor, 0.001 L/cm³</p> <p>Kp = Permeability Coefficient (cm/hr)</p>
--	--

Analyte	Dermal RfD (mg/kg-day)	Carc. Slope Dermal (mg/kg-day)-1	Permeability Coefficient Kp (cm/hr)	EPC Groundwater (mg/liter)	Resident (Adult)					Resident (Child)				Resident Total Lifetime Cancer Risk	
					Absorbed Dose/Event DA _{event} (mg/cm ² -event)	Intake (mg/kg-day)		Hazard Quotient	Contribution to Lifetime Cancer Risk	Absorbed Dose/Event DA _{event} (mg/cm ² -event)	Intake (mg/kg-day)		Hazard Quotient		Contribution to Lifetime Cancer Risk
						(Nc)	(Car)				(Nc)	(Car)			
Antimony	6E-05	N/A	1E-03	8.6E-03	5E-09	1.2E-06	9.8E-08	2E-02	1E-07	9E-09	3.6E-06	7.2E-08	6E-02	1E-07	3E-07
Arsenic	3E-04	1.5E+00	1E-03	2E-03	1E-09	2.9E-07	9.8E-08	1E-03	1E-07	2E-09	8.4E-07	7.2E-08	3E-03	1E-07	
Iron	3E-01	N/A	1E-03	3.94E+00	2E-06	5.6E-04		2E-03		4E-06	1.7E-03		6E-03		
Manganese	9E-04	N/A	1E-03	7.8E-01	5E-07	1.1E-04		1E-01		8E-07	3.3E-04		4E-01		
Thallium	6E-04	N/A	1E-03	4E-03	2E-09	5.7E-07		9E-04		4E-09	1.7E-06		3E-03		
Vanadium	3E-05	N/A	1E-03	5.26E-03	3E-09	7.5E-07		3E-02		5E-09	2.2E-06		9E-02		
Total Hazard Quotient and Cancer Risk:								2E-01	1E-07				5E-01	1E-07	3E-07
					Assumptions for Resident (Adult)					Assumptions for Resident (Child)					
					BW = 70 kg					BW = 15 kg					
					SA = 18,000 cm ²					SA = 6,600 cm ²					
					t _{event} = 0.58 hours/event					t _{event} = 1.0 hours/event					
					EF = 350 days/year					EF = 350 days/year					
					ED = 24 years					ED = 6 years					
					EV = 1 event/day					EV = 1 event/day					
					AT (Nc) 8,760 days					AT (Nc) 2,190 days					
					AT (Car) 25,550 days					AT (Car) 25,550 days					

N/A= Information not available.

Kp values from Exhibit 3-1 of USEPA (2004) Supplemental Guidance for Dermal Risk Assessment, Part E of Risk Assessment Guidance for Superfund, Human Health Evaluation Manual (Volume I).

**TABLE I-5B
CALCULATION OF INTAKE AND RISK FROM DERMAL CONTACT TO GROUNDWATER (WHILE SHOWERING) FOR RESIDENTIAL RECEPTORS
CENTRAL TENDENCY (CT)
SEAD-59/71 Phase II RI
Seneca Army Depot Activity**

<p>Equation for Intake (mg/kg-day) = $\frac{DA_{event} \times SA \times EF \times ED \times EV}{BW \times AT}$</p> <p><u>Variables (Assumptions for Each Receptor are Listed at the Bottom):</u></p> <p>DA_{event} = Absorbed Dose per Event (mg/event-cm²)</p> <p>SA = Surface Area Contact (cm²)</p> <p>EF = Exposure Frequency (day/year)</p> <p>ED = Exposure Duration (year)</p> <p>EV = Event Frequency (event/day)</p> <p>BW = Body Weight (kg)</p> <p>AT = Averaging Time (day)</p>	<p>Equation for Absorbed Dose per Event (DA):</p> <p>For inorganics: $DA_{event} = Kp \times EPC \times t_{event} \times CF$</p> <p>EPC = Exposure Point Concentration (mg/L)</p> <p>t_{event} = Event Duration (hr/event)</p> <p>CF = Conversion Factor, 0.001 L/cm³</p> <p>Kp = Permeability Coefficient (cm/hr)</p>
--	--

Analyte	Dermal	Carc. Slope	Permeability	EPC	Resident (Adult)					Resident (Child)				Resident		
	RfD	Dermal	Coefficient	Groundwater	Absorbed Dose/Event	Intake (mg/kg-day)		Hazard Quotient	Contribution to Lifetime Cancer Risk	Absorbed Dose/Event	Intake (mg/kg-day)		Hazard Quotient	Contribution to Lifetime Cancer Risk	Total Lifetime Cancer Risk	
	(mg/kg-day)	(mg/kg-day) ⁻¹	(cm/hr)	(mg/liter)	(mg/cm ² -event)	(Nc)	(Car)			(mg/cm ² -event)	(Nc)	(Car)				
Antimony	6E-05	N/A	1E-03	8.6E-03	2E-09	5.3E-07	1.6E-08	9E-03		3E-09	1.2E-06	2.4E-08	2E-02			
Arsenic	3E-04	1.5E+00	1E-03	2E-03	5E-10	1.2E-07	1.6E-08	4E-04	2E-08	7E-10	2.8E-07	2.4E-08	9E-04	4E-08	6E-08	
Iron	3E-01	N/A	1E-03	3.94E+00	1E-06	2.4E-04		8E-04		1E-06	5.5E-04		2E-03			
Manganese	9E-04	N/A	1E-03	7.8E-01	2E-07	4.8E-05		5E-02		3E-07	1.1E-04		1E-01			
Thallium	6E-04	N/A	1E-03	4E-03	1E-09	2.5E-07		4E-04		1E-09	5.6E-07		9E-04			
Vanadium	3E-05	N/A	1E-03	5.26E-03	1E-09	3.2E-07		1E-02		2E-09	7.3E-07		3E-02			
Total Hazard Quotient and Cancer Risk:								7E-02	2E-08				2E-01	4E-08	6E-08	
					Assumptions for Resident (Adult)					Assumptions for Resident (Child)						
						BW = 70 kg				BW = 15 kg						
						SA = 18,000 cm ²				SA = 6,600 cm ²						
						t _{event} = 0.25 hours/event				t _{event} = 0.33 hours/event						
						EF = 350 days/year				EF = 350 days/year						
						ED = 9 years				ED = 6 years						
						EV = 1 event/day				EV = 1 event/day						
						AT (Nc) = 3,285 days				AT (Nc) = 2,190 days						
						AT (Car) = 25,550 days				AT (Car) = 25,550 days						

N/A= Information not available.

Kp values from Exhibit 3-1 of USEPA (2004) Supplemental Guidance for Dermal Risk Assessment, Part E of Risk Assessment Guidance for Superfund, Human Health Evaluation Manual (Volume I).

TABLE I-6A
CALCULATION OF INTAKE AND RISK FROM THE INTAKE OF GROUNDWATER FOR RESIDENTIAL RECEPTORS
REASONABLE MAXIMUM EXPOSURE (RME) - SEAD-59
SEAD-59/71 Phase II RI
Seneca Army Depot Activity

<p>Equation for Intake (mg/kg-day) = $\frac{EPC \times IR \times EF \times ED}{BW \times AT}$</p> <p>Variables (Assumptions for Each Receptor are Listed at the Bottom): EPC = Exposure Point Concentration in Groundwater (mg/L) ED=Exposure Duration, year IR = Intake Rate, L/day BW=Bodyweight, kg EF = Exposure Frequency, day/year AT=Averaging Time, day</p>	<p>Equation for Hazard Quotient = Chronic Daily Intake (Nc)/Reference Dose</p> <p>Equation for Cancer Risk = Chronic Daily Intake (Car) x Slope Factor</p>
--	--

Analyte	Oral RfD (mg/kg-day)	Carc. Slope Oral (mg/kg-day) ⁻¹	EPC Groundwater (mg/liter)	Residential Adult				Residential Child			Resident Total Lifetime Cancer Risk	
				Intake (mg/kg-day)		Hazard Quotient	Contribution to Lifetime Cancer Risk	Intake (mg/kg-day)		Hazard Quotient		Contribution to Lifetime Cancer Risk
				(Nc)	(Car)			(Nc)	(Car)			
Antimony	4E-04	N/A	0.0086	2.4E-04	8.1E-05	6E-01		8.2E-04	7.1E-05	2E+00		
Arsenic	3E-04	1.5E+00	0.002	5.5E-05	1.9E-05	2E-01	3E-05	1.9E-04	1.6E-05	6E-01	2E-05	5E-05
Iron	3E-01	N/A	3.94	1.1E-01	3.7E-02	4E-01		3.8E-01	3.2E-02	1E+00		
Manganese	2.3E-02	N/A	0.78	2.1E-02	7.3E-03	9E-01		7.5E-02	6.4E-03	3E+00		
Thallium	6E-04	N/A	0.004	1.1E-04	3.8E-05	2E-01		3.8E-04	3.3E-05	6E-01		
Vanadium	1.0E-03	N/A	0.00526	1.4E-04	4.9E-05	1E-01		5.0E-04	4.3E-05	5E-01		
Total Hazard Quotient and Cancer Risk:						2E+00	3E-05			6E+00	2E-05	5E-05
				Assumptions for Residential Adult				Assumptions for Residential Child				
				BW =	70 kg			BW =	15 kg			
				IR =	2 liters/day			IR =	1.5 liters/day			
				EF =	350 days/year			EF =	350 days/year			
				ED =	24 years			ED =	6 years			
				AT (Nc) =	8,760 days			AT (Nc) =	2,190 days			
				AT (Car) =	25,550 days			AT (Car) =	25,550 days			

Note: Cells in this table were intentionally left blank due to a lack of toxicity data.
N/A= Information not available.

TABLE I-6B
CALCULATION OF INTAKE AND RISK FROM THE INTAKE OF GROUNDWATER FOR RESIDENTIAL RECEPTORS
CENTRAL TENDENCY (CT) - SEAD-59
SEAD-59/71 Phase II RI
Seneca Army Depot Activity

Equation for Intake (mg/kg-day) = $\frac{EPC \times IR \times EF \times ED}{BW \times AT}$ Variables (Assumptions for Each Receptor are Listed at the Bottom): EPC = Exposure Point Concentration in Groundwater (mg/L) IR = Intake Rate, L/day EF = Exposure Frequency, day/year ED=Exposure Duration, year BW=Bodyweight, kg AT=Averaging Time, day	Equation for Hazard Quotient = Chronic Daily Intake (Nc)/Reference Dose Equation for Cancer Risk = Chronic Daily Intake (Car) x Slope Factor
---	---

Analyte	Oral RfD (mg/kg-day)	Carc. Slope Oral (mg/kg-day) ⁻¹	EPC Groundwater (mg/liter)	Residential Adult				Residential Child				Resident
				Intake (mg/kg-day)		Hazard Quotient	Contribution to Lifetime Cancer Risk	Intake (mg/kg-day)		Hazard Quotient	Contribution to Lifetime Cancer Risk	Total Lifetime Cancer Risk
				(Nc)	(Car)			(Nc)	(Car)			
Antimony	4E-04	N/A	0.0086	1.7E-04	2.1E-05	4E-01	7E-06	4.1E-04	3.5E-05	1E+00	1E-05	2E-05
Arsenic	3E-04	1.5E+00	0.002	3.9E-05	5.0E-06	1E-01		9.5E-05	8.1E-06	3E-01		
Iron	3E-01	N/A	3.94	7.6E-02	9.8E-03	3E-01		1.9E-01	1.6E-02	6E-01		
Manganese	2.3E-02	N/A	0.78	1.5E-02	1.9E-03	6E-01		3.7E-02	3.2E-03	2E+00		
Thallium	6E-04	N/A	0.004	7.7E-05	9.9E-06	1E-01		1.9E-04	1.6E-05	3E-01		
Vanadium	1.0E-03	N/A	0.00526	1.0E-04	1.3E-05	1E-01		2.5E-04	2.1E-05	2E-01		
Total Hazard Quotient and Cancer Risk:						1E+00	7E-06			3E+00	1E-05	2E-05
				Assumptions for Residential Adult				Assumptions for Residential Child				
				BW =	70 kg			BW =	15 kg			
				IR =	1.41 liters/day			IR =	0.74 liters/day			
				EF =	350 days/year			EF =	350 days/year			
				ED =	9 years			ED =	6 years			
				AT (Nc) =	3,285 days			AT (Nc) =	2,190 days			
				AT (Car) =	25,550 days			AT (Car) =	25,550 days			

Note: Cells in this table were intentionally left blank due to a lack of toxicity data.
 N/A= Information not available.

Appendix J

Ecological Risk Assessment Calculation Tables

- J-1A SEAD-59 Soil (0-2 ft bgs) - Occurrence, Distribution, and Selection of Chemicals of Potential Concern
- J-1B SEAD-59 Soil (0-4 ft bgs) - Occurrence, Distribution, and Selection of Chemicals of Potential Concern
- J-2 SEAD-59 Stockpile Soil - Occurrence, Distribution, and Selection of Chemicals of Potential Concern
- J-3A SEAD-71 Soil (0-2 ft bgs) - Occurrence, Distribution, and Selection of Chemicals of Potential Concern
- J-3B SEAD-71 Soil (0-4 ft bgs) - Occurrence, Distribution, and Selection of Chemicals of Potential Concern
- J-4 Conversion Factors
- J-5 NOAEL Screening Ecotoxicity Values – Deer Mouse, American Robin, Short-Tailed Shrew, and Red Fox
- J-6 LOAEL Screening Ecotoxicity Values – Deer Mouse, American Robin, Short-Tailed Shrew, and Red Fox
- J-7 Receptor Intake Rates and Dietary Fractions
- J-8 Chemical-Specific Uptake Factors
- J-9A SEAD-59 Soil - Exposure Point Concentrations
- J-9B SEAD-59 Stockpile Soil - Exposure Point Concentrations
- J-9C SEAD-71 Soil - Exposure Point Concentrations
- J-9D SEAD-71 (Fenced Area Excluded) Soil - Exposure Point Concentrations
- J-10A SEAD-59 Soil - Deer Mouse (*Peromyscus maniculatus*) Exposure
- J-10B SEAD-59 Stockpile Soil - Deer Mouse (*Peromyscus maniculatus*) Exposure
- J-10C SEAD-71 Soil - Deer Mouse (*Peromyscus maniculatus*) Exposure
- J-10D SEAD-71 (Fenced Area Excluded) Soil - Deer Mouse (*Peromyscus maniculatus*) Exposure
- J-11A SEAD-59 Soil – American Robin (*Turdus migratorius*) Exposure
- J-11B SEAD-59 Stockpile Soil - American Robin (*Turdus migratorius*) Exposure

Appendix J (Continued)

Ecological Risk Assessment Calculation Tables

- J-11C SEAD-71 Soil - American Robin (*Turdus migratorius*) Exposure
- J-11D SEAD-71 (Fenced Area Excluded) Soil - American Robin (*Turdus migratorius*) Exposure
- J-12A SEAD-59 Soil – Short-Tailed Shrew (*Blarina brevicauda*) Exposure
- J-12B SEAD-59 Stockpile Soil - Short-Tailed Shrew (*Blarina brevicauda*) Exposure
- J-12C SEAD-71 Soil - Short-Tailed Shrew (*Blarina brevicauda*) Exposure
- J-12D SEAD-71 (Fenced Area Excluded) Soil - Short-Tailed Shrew (*Blarina brevicauda*) Exposure
- J-13A SEAD-59 Soil – Red Fox (*Vulpes vulpes*) Exposure
- J-13B SEAD-59 Stockpile Soil - Red Fox (*Vulpes vulpes*) Exposure
- J-13C SEAD-71 Soil - Red Fox (*Vulpes vulpes*) Exposure
- J-13D SEAD-71 (Fenced Area Excluded) Soil - Red Fox (*Vulpes vulpes*) Exposure
- J-14A SEAD-59 – Receptor NOAEL Hazard Quotients
- J-14B SEAD-59 Stockpile Soil - Receptor NOAEL Hazard Quotients
- J-14C SEAD-71 – Receptor NOAEL Hazard Quotients
- J-14D SEAD-71 (Fenced Area Excluded) – Receptor NOAEL Hazard Quotients
- J-15A SEAD-59 Soil – Receptor LOAEL Hazard Quotients Based on Maximum Concentration
- J-15B SEAD-59 Stockpile Soil – Receptor LOAEL Hazard Quotients Based on Maximum Concentration
- J-15C SEAD-71 (Fenced Area Excluded) Soil – Receptor LOAEL Hazard Quotients Based on Maximum Concentration
- J-16A Average Concentration for Preliminary COCs SEAD-59 Soil
- J-16B Average Concentration for Preliminary COCs SEAD-59 Stockpile Soil
- J-16C Average Concentration for Preliminary COCs SEAD-71 (Fenced Area Excluded) Soil
- J-17A SEAD-59 Soil – Receptor NOAEL Hazard Quotients Based on Average Concentration
- J-17B SEAD-59 Stockpile Soil – Receptor Hazard Quotients Based on Average Concentration

Appendix J (Continued)

Ecological Risk Assessment Calculation Tables

- J-17C SEAD-71 (Fenced Area Excluded) Soil – Receptor NOAEL Hazard Quotients Based on Average Concentration
- J-18A SEAD-59 Soil – Receptor LOAEL Hazard Quotients Based on Average Concentration
- J-18C SEAD-71 (Fenced Area Excluded) Soil – Receptor LOAEL Hazard Quotients Based on Average Concentration
- J-19A SEAD-59 Soil – Comparison of Site Concentrations with Background
- J-19B SEAD-59 Stockpile Soil – Comparison of Site Concentrations with Background
- J-19C SEAD-71 Soil – Comparison of Site Concentrations with Background

Table J-1A
OCCURRENCE, DISTRIBUTION AND SELECTION OF CHEMICALS OF POTENTIAL CONCERN IN SEAD-59 SURFACE SOIL (0-2 FT BGS.)
SEAD-59 AND SEAD-71 PHASE II RI
Seneca Army Depot Activity

CAS Number	Chemical	Minimum Detected Concentration ¹ (mg/kg)	Q	Maximum Detected Concentration ¹ (mg/kg)	Q	Location of Maximum Concentration	Detection Frequency ¹	Range of Reporting Limits ¹ (mg/kg)	Screening Value (mg/kg)	Source of Screening Value ²	COPC Flag	Rationale for Contaminant Deletion or Selection ³
VOC												
75-35-4	1,1-Dichloroethene	0.001	J	0.008	J	CL-59-01-WS5	3 / 184	0.004 - 0.023	0.1	CCME, Dutch target value	NO	BSL
67-64-1	Acetone	0.004	J	0.55	NJ	CL-59-01-WE4	46 / 184	0.004 - 0.047	2.5	Region 5 - Ecological Screening Value	NO	BSL
71-43-2	Benzene	0.001	J	0.0058	J	FD-71-CL-04/CL-59-01-F01	7 / 184	0.004 - 0.023	0.1	Region III BTAG - soil fauna	NO	BSL
75-15-0	Carbon disulfide	0.001	J	0.004	J	SB59-4	6 / 184	0.004 - 0.023	0.094	Region 5 - Ecological Screening Value	NO	IDL
110-82-7	Cyclohexane	0.001	J	0.003	J	WS-59-04-010-5	8 / 98	0.004 - 0.023	NA		NO	IDL
100-41-4	Ethyl benzene	0.0023	J	0.00315	J	FD-59-WS-01/WS-59-03-001-3	2 / 184	0.004 - 0.023	0.1	Region III BTAG - soil fauna	NO	BSL
	Meta/Para Xylene	0.0051	J	0.0084		WS-59-03-001-2	3 / 70	0.0054 - 0.006	0.1	Region III BTAG - soil fauna for Xylene	NO	BSL
79-20-9	Methyl Acetate	0.001	J	0.002	J	CL-59-OTHERB-WE1	3 / 98	0.004 - 0.023	NA		NO	IDL
108-87-2	Methyl cyclohexane	0.001	J	0.005	J	WS-59-04-010-5	10 / 98	0.004 - 0.023	NA		NO	IDL
78-93-3	Methyl ethyl ketone	0.002	J	0.19	J	CL-59-01-WE4	22 / 184	0.004 - 0.018	35	Dutch - Indicative Level	NO	BSL
108-10-1	Methyl isobutyl ketone	0.0019	J	0.0019	J	CL-59-OTHERC-WS1	1 / 184	0.004 - 0.023	100	Region III BTAG - soil fauna	NO	BSL
75-09-2	Methylene chloride	0.001	J	0.0049	J	WS-59-01-018-1	36 / 185	0.004 - 0.023	0.3	Region III BTAG - soil fauna	NO	BSL
95-47-6	Ortho Xylene	0.0011	NJ	0.0036	J	FD-59-WS-01/WS-59-03-001-3	3 / 70	0.0054 - 0.006	0.1	Region III BTAG - soil fauna for Xylene	NO	BSL
127-18-4	Tetrachloroethene	0.002	J	0.0064		WS-59-01-017-1	5 / 184	0.004 - 0.023	0.3	Region III BTAG - soil fauna	NO	BSL
108-88-3	Toluene	0.0009	J	0.011		WS-59-04-010-5	15 / 184	0.004 - 0.023	0.1	Region III BTAG - soil fauna	NO	BSL
	Total BTEX	0.0025		0.0065		SB59-21	9 / 10	0 - 1.25	NA		NO	ICE
133-02-07	Total Xylenes	0.001	J	0.073	J	CL-59-02-WW1	7 / 109	0.004 - 0.023	0.1	Region III BTAG - soil fauna for Xylene	NO	BSL
79-01-6	Trichloroethene	0.001	J	0.0045	J	WS-59-01-006-4	8 / 184	0.004 - 0.023	0.3	Region III BTAG - soil fauna	NO	BSL
75-69-4	Trichlorofluoromethane	0.006	J	0.006	J	WS-59-04-010-6	1 / 98	0.004 - 0.023	16.4	Region 5 - Ecological Screening Value	NO	BSL
SVOC												
92-52-4	1,1'-Biphenyl	0.059	NJ	0.15	J	FD-59-W5-6/WS-59-01-012-1	2 / 99	0.35 - 1.9	60	Oak Ridge - Effects on Terrestrial Plants 1997 Rev, Table 1	NO	BSL
91-57-6	2-Methylnaphthalene	0.01	J	0.97		TP59-17-3	38 / 185	0.066 - 4	3.24	Region 5 - Ecological Screening Value	NO	BSL
106-47-8	4-Chloroaniline	0.13	J	1.2		CL-59-01-WN2	2 / 185	0.066 - 4	1.1	Region 5 - Ecological Screening Value	NO	IDL
106-44-5	4-Methylphenol	0.024	NJ	0.15	J	CL-59-01-WN5	5 / 185	0.066 - 4	0.1	Region III BTAG - soil fauna	NO	IDL
83-32-9	Acenaphthene	0.0061	J	2.68	J	FD-59-WS-07/WS-59-01-015-13	46 / 185	0.066 - 4	20	Oak Ridge - Effects on Terrestrial Plants 1997 Rev, Table 1	YES	IBC
208-96-8	Acenaphthylene	0.0079	J	1.7	J	WS-59-01-006-11	70 / 185	0.066 - 2	0.1	Region III BTAG - soil fauna	YES	ASL
120-12-7	Anthracene	0.0084	J	4.395	J	FD-59-WS-07/WS-59-01-015-13	81 / 185	0.066 - 2	0.1	Region III BTAG - soil fauna	YES	ASL
1912-24-9	Atrazine	0.12	J	0.12	J	CL-59-01-WN2	1 / 99	0.35 - 1.9	NA		NO	IDL
100-52-7	Benzaldehyde	0.05	J	0.05	J	CL-59-01-WE4	1 / 99	0.35 - 1.9	NA		NO	IDL
56-55-3	Benzo(a)anthracene	0.0066	J	8.9	J	FD-59-WS-07/WS-59-01-015-13	96 / 185	0.069 - 0.46	0.1	Region III BTAG - soil fauna	YES	ASL
50-32-8	Benzo(a)pyrene	0.007	J	8.05	J	FD-59-WS-07/WS-59-01-015-13	97 / 185	0.069 - 0.46	0.1	Region III BTAG - soil fauna	YES	ASL

Table J-1A
OCCURRENCE, DISTRIBUTION AND SELECTION OF CHEMICALS OF POTENTIAL CONCERN IN SEAD-59 SURFACE SOIL (0-2 FT BGS.)
SEAD-59 AND SEAD-71 PHASE II RI
Seneca Army Depot Activity

CAS Number	Chemical	Minimum Detected Concentration ¹ (mg/kg)	Q	Maximum Detected Concentration ¹ (mg/kg)	Q	Location of Maximum Concentration	Detection Frequency ¹	Range of Reporting Limits ¹ (mg/kg)	Screening Value (mg/kg)	Source of Screening Value ²	COPC Flag	Rationale for Contaminant Deletion or Selection ³
205-99-2	Benzo(b)fluoranthene	0.0048	J	6.8	J	FD-59-WS-07/WS-59-01-015-13	99 / 185	0.35 - 0.46	0.1	Region III BTAG - soil fauna	YES	ASL
191-24-2	Benzo(ghi)perylene	0.0063	J	5.2	J	FD-59-WS-07/WS-59-01-015-13	88 / 185	0.069 - 0.46	0.1	Region III BTAG - soil fauna	YES	ASL
207-08-9	Benzo(k)fluoranthene	0.0084	J	7.35	J	FD-59-WS-07/WS-59-01-015-13	93 / 185	0.069 - 0.82	0.1	Region III BTAG - soil fauna	YES	ASL
117-81-7	Bis(2-Ethylhexyl)phthalate	0.016	J	0.52	J	SB59-1	38 / 185	0.35 - 4	0.925	Region 5 - Ecological Screening Value	NO	BSL
85-68-7	Butylbenzylphthalate	1	J	1	J	TP59-15-5	1 / 185	0.066 - 4	0.239	Region 5 - Ecological Screening Value	NO	IDL
86-74-8	Carbazole	0.0066	J	0.755	J	SB59-1	25 / 115	0.069 - 1.9	NA		YES	NSV
218-01-9	Chrysene	0.0078	J	8.9	J	FD-59-WS-07/WS-59-01-015-13	97 / 185	0.069 - 0.46	0.1	Region III BTAG - soil fauna	YES	ASL
53-70-3	Dibenz(a,h)anthracene	0.0047	J	1.665	J	FD-59-WS-07/WS-59-01-015-13	72 / 185	0.066 - 2	0.1	Region III BTAG - soil fauna	YES	ASL
132-64-9	Dibenzofuran	0.0056	J	1.875	J	FD-59-WS-07/WS-59-01-015-13	32 / 185	0.066 - 4	NA		YES	NSV
84-66-2	Diethylphthalate	0.0081	J	0.012	J	SB59-9	4 / 185	0.15 - 4	100	Oak Ridge - Effects on Terrestrial Plants 1997 Rev, Table 1	NO	BSL
84-74-2	Di-n-butylphthalate	0.0048	J	0.49	J	SB59-1	8 / 185	0.35 - 4	200	Oak Ridge - Effects on Terrestrial Plants 1997 Rev, Table 1	NO	BSL
117-84-0	Di-n-octylphthalate	0.011	J	0.011	J	SB59-8	1 / 185	0.066 - 4	NA		NO	IDL
206-44-0	Fluoranthene	0.011	J	23.5	J	FD-59-WS-07/WS-59-01-015-13	103 / 185	0.069 - 0.46	0.1	Region III BTAG - soil fauna	YES	ASL
86-73-7	Fluorene	0.0086	J	2.64	J	FD-59-WS-07/WS-59-01-015-13	53 / 185	0.066 - 4	30	Oak Ridge - Benchmark concentrations for earthworms, Table 1	YES	IBC
193-39-5	Indeno(1,2,3-cd)pyrene	0.006	J	4.95	J	FD-59-WS-07/WS-59-01-015-13	90 / 185	0.069 - 0.46	0.1	Region III BTAG - soil fauna	YES	ASL
91-20-3	Naphthalene	0.011	J	1.325	J	FD-59-WS-07/WS-59-01-015-13	37 / 185	0.066 - 4	0.1	Region III BTAG - soil fauna	YES	ASL
86-30-6	N-Nitrosodiphenylamine	0.1	J	0.1	J	CL-59-01-WN2	1 / 115	0.066 - 1.9	20	Oak Ridge - Benchmark concentrations for earthworms, Table 1	NO	BSL
85-01-8	Phenanthrene	0.006	J	21.3	J	FD-59-WS-07/WS-59-01-015-13	96 / 185	0.069 - 0.46	0.1	Region III BTAG - soil fauna	YES	ASL
129-00-0	Pyrene	0.013	J	19.2	J	FD-59-WS-07/WS-59-01-015-13	104 / 185	0.069 - 0.46	0.1	Region III BTAG - soil fauna	YES	ASL
PCB												
11096-82-5	Aroclor-1260	0.077		0.079	NJ	CL-59-OTHERC-WE2	2 / 185	0.035 - 0.42	0.1	Region III BTAG - soil flora	NO	IDL
Pesticides												
72-54-8	4,4'-DDD	0.0025	J	0.74	J	CL-59-01-WN2	50 / 185	0.0034 - 0.099	0.1	Region III BTAG - soil fauna	YES	ASL
72-55-9	4,4'-DDE	0.0025	J	2.6	J	CL-59-01-WN2	68 / 185	0.0034 - 0.099	0.1	Region III BTAG - soil fauna	YES	ASL
50-29-3	4,4'-DDT	0.0024	J	3.7	J	CL-59-01-WN2	62 / 185	0.0034 - 0.099	0.1	Region III BTAG - soil fauna	YES	ASL
309-00-2	Aldrin	0.0012	J	0.0012	J	SB59-2	1 / 185	0.0018 - 0.22	0.1	Region III BTAG - soil fauna	NO	BSL
319-84-6	Alpha-BHC	0.009		0.009		SB59-8	1 / 185	0.0018 - 0.22	0.0994	Region 5 - Ecological Screening Value	NO	BSL
5103-71-9	Alpha-Chlordane	0.0011	J	0.034	J	WS-59-04-010-10	8 / 185	0.0018 - 0.22	0.1	Region III BTAG for chlordane	NO	BSL
319-85-7	Beta-BHC	0.0024	J	0.0036	J	SB59-8	3 / 185	0.0018 - 0.22	0.00398	Region 5 - Ecological Screening Value	NO	BSL

**Table J-1A
 OCCURRENCE, DISTRIBUTION AND SELECTION OF CHEMICALS OF POTENTIAL CONCERN IN SEAD-59 SURFACE SOIL (0-2 FT BGS.)
 SEAD-59 AND SEAD-71 PHASE II RI
 Seneca Army Depot Activity**

CAS Number	Chemical	Minimum Detected Concentration ¹ (mg/kg)	Q	Maximum Detected Concentration ¹ (mg/kg)	Q	Location of Maximum Concentration	Detection Frequency ¹	Range of Reporting Limits ¹ (mg/kg)	Screening Value (mg/kg)	Source of Screening Value ²	COPC Flag	Rationale for Contaminant Deletion or Selection ³
319-86-8	Delta-BHC	0.0011	J	0.0014	J	SB59-8	2 / 185	0.0018 - 0.22	9.94	Region 5 - Ecological Screening Value	NO	BSL
60-57-1	Dieldrin	0.0018	J	0.0018	J	TP59-8-2	1 / 185	0.0034 - 0.43	0.00003	USEPA 2005 mammalian	NO	IDL
959-98-8	Endosulfan I	0.016	J	0.016	J	SB59-2	1 / 185	0.0018 - 0.22	0.119	Region 5 - Ecological Screening Value	NO	BSL
1031-07-8	Endosulfan sulfate	0.0062	J	0.0062	J	CL-59-OTHERC-WE2	1 / 185	0.0034 - 0.43	0.0358	Region 5 - Ecological Screening Value	NO	BSL
72-20-8	Endrin	0.0038	NJ	0.016	NJ	CL-59-04-FO1	4 / 185	0.0034 - 0.43	0.1	Region III BTAG - soil fauna	NO	BSL
7421-93-4	Endrin aldehyde	0.0035	J	0.003825	NJ	FD-59-W5-6/WS-59-01-012-1	3 / 185	0.0034 - 0.43	0.0105	Region 5 - Ecological Screening Value	NO	IDL
53494-70-5	Endrin ketone	0.0033	J	0.038		WS-59-01-011-3	5 / 185	0.0034 - 0.43	NA		NO	IDL
5103-74-2	Gamma-Chlordane	0.001	J	0.024	J	WS-59-04-010-10	15 / 185	0.0018 - 0.22	0.1	Region III BTAG for chlordane	NO	BSL
1024-57-3	Heptachlor epoxide	0.001	J	0.003	J	TP59-9-2	3 / 185	0.0018 - 0.22	0.1	Region III BTAG - soil fauna	NO	BSL
Metals												
7429-90-5	Aluminum	4,200		18,300	J	CL-59-01-F12	185 / 185		NA		NO	NPH
7440-36-0	Antimony	0.65	J	424	J	SB59-4	104 / 185	0.14 - 3.62	0.27	USEPA, 2005, mammalian	YES	ASL
7440-38-2	Arsenic	2.3	J	32.2		CL-59-01-WN2	185 / 185		18	USEPA, 2005, plants	YES	IBC
7440-39-3	Barium	21.1	J	304		SB59-4	185 / 185		330	USEPA, 2005, soil invertebrates	NO	BSL
7440-41-7	Beryllium	0.11	J	2.6		CL-59-01-WN2	183 / 185	0.05 - 0.045	21	USEPA, 2005, mammalian	NO	BSL
7440-43-9	Cadmium	0.13	J	3.2		SB59-4	153 / 185	0.08 - 0.15	0.36	USEPA, 2005, mammalian	YES	ASL
7440-70-2	Calcium	1,350	J	214,000		SB59-4	185 / 185		NA		NO	NUT
7440-47-3	Chromium	7.4	J	39.3	J	CL-59-01-WN2	185 / 185		26	USEPA, 2005, avain, Cr (IV)	YES	ASL
7440-48-4	Cobalt	3.8	J	47.8		CL-59-01-WN2	185 / 185		13	USEPA, 2005, plants	YES	ASL
7440-50-8	Copper	9.8	J	305		WS-59-01-013-5	185 / 185		61	USEPA, 2005, soil invertebrates	YES	ASL
7439-89-6	Iron	6,540		64,000	J	CL-59-01-WN2	185 / 185		NA		NO	NPH
7439-92-1	Lead	4.1	J	164		WS-59-01-006-8	185 / 185		11	USEPA, 2005, avian	YES	ASL
7439-95-4	Magnesium	2,530		30,200	J	CL-59-01-WS3	185 / 185		4,400	Region III BTAG, 1995	NO	NUT
7439-96-5	Manganese	156	J	1290	J	CL-59-01-WS6	185 / 185		100	Oak Ridge - microorganisms and microbial process	YES	ASL
7439-97-6	Mercury	0.02	J	0.95	J	WS-59-04-010-6	174 / 185	0.02 - 0.03	0.1	Oak Ridge - Benchmark concentrations for earthworms, Table 1	YES	ASL
7440-02-0	Nickel	9	J	88.3	J	CL-59-01-WN2	185 / 185		30	Oak Ridge - Effects on Terrestrial Plants 1997 Rev, Table 1	YES	ASL
7440-09-7	Potassium	539	J	2,290	J	SB59-1	185 / 185		NA		NO	NUT
7782-49-2	Selenium	0.28	J	1.5		SB59-21	19 / 185	0.26 - 0.58	1	Oak Ridge - Effects on Terrestrial Plants 1997 Rev, Table 1	YES	ASL
7440-22-4	Silver	0.11	J	2.9		CL-59-OTHERA-WN1	88 / 185	0.1 - 0.31	2	Oak Ridge - Effects on Terrestrial Plants 1997 Rev, Table 1	YES	ASL
7440-23-5	Sodium	33.3	J	4,060	J	CL-59-01-WE5	180 / 185	83.1 - 57.5	NA		NO	NUT
7440-28-0	Thallium	0.11		1.8	J	CL-59-03-WS3	51 / 185	0.18 - 0.75	1	Oak Ridge - Effects on Terrestrial Plants 1997 Rev, Table 1	YES	ASL

**Table J-1A
 OCCURRENCE, DISTRIBUTION AND SELECTION OF CHEMICALS OF POTENTIAL CONCERN IN SEAD-59 SURFACE SOIL (0-2 FT BGS.)
 SEAD-59 AND SEAD-71 PHASE II RI
 Seneca Army Depot Activity**

CAS Number	Chemical	Minimum Detected Concentration ¹ (mg/kg)	Q	Maximum Detected Concentration ¹ (mg/kg)	Q	Location of Maximum Concentration	Detection Frequency ¹	Range of Reporting Limits ¹ (mg/kg)	Screening Value (mg/kg)	Source of Screening Value ²	COPC Flag	Rationale for Contaminant Deletion or Selection ³
7440-62-2	Vanadium	8.4	J	28.5	J	CL-59-01-F12	185 / 185		2	Oak Ridge - Effects on Terrestrial Plants 1997 Rev, Table 1	YES	ASL
7440-66-6	Zinc	19.6	J	341		SB59-4	185 / 185		120	USEPA, 2000, soil invertebrates	YES	ASL

Notes:

- Field duplicates were treated as discrete samples. Lab duplicates were not included in the assessment.
 Range of reporting limits were presented for nondetects only. The maximum detected concentration was used for screening.
 - Source of Screening Values:
 - USEPA Ecological Soil Screen Levels, 2000, 2003, 2005
 - USEPA Region III BTAG Screen levels
 - USEPA Region 5 Ecological Soil Screening Levels, December 2003
 - Oak Ridge, R.A. Efroymson, G.W. Suter II, B.E. Sample, and D.S. Jones, *Preliminary Remediation Goals for Ecological Endpoints* , August 1997
 - Toxicological Benchmarks for Contaminants of Potential Concern for Effects on Soil and Litter Invertebrates and Heterotrophic Process* , 1997 Revision
 - Toxicological Benchmarks for Screening Contaminants of Potential Concern for Effects on terrestrial Plants* , 1997 Revisions
 - CCME - Canadian Environmental Quality Guidelines, December 2003
 - Dutch, *Annexes Circular on target values and intervention values for soil remediation* , February 2000
 - Rationale codes
 - Selection Reason:
 - Above Screening Levels (ASL)
 - No Screening Value (NSV)
 - Important Bioaccumulative Compounds (IBC)
 - Deletion Reason:
 - Essential Nutrient (NUT)
 - Below Screening Level (BSL)
 - Infrequent Detection with Low Concentrations (IDL)
 - Individual Chemicals Evaluated (ICE)
 - Neutral pH Value Expected for Soil (NPH)
- Definitions:
 COPC = Chemical of Potential Concern
 Q = Qualifier
 J = Estimated Value
 NJ = Presence of the analyte has been "tentatively identified" and the associated numerical value represents its approximate concentration.

Table J-1B
OCCURRENCE, DISTRIBUTION AND SELECTION OF CHEMICALS OF POTENTIAL CONCERN IN SEAD-59 SOIL (0-4 FT BGS.)
SEAD-59 AND SEAD-71 PHASE II RI
Seneca Army Depot Activity

CAS Number	Chemical	Minimum Detected Concentration ¹ (mg/kg)	Q	Maximum Detected Concentration ¹ (mg/kg)	Q	Location of Maximum Concentration	Detection Frequency ¹	Range of Reporting Limits ¹ (mg/kg)	Screening Value (mg/kg)	Source of Screening Value ²	COPC Flag	Rationale for Contaminant Deletion or Selection ³
VOC												
75-35-4	1,1-Dichloroethene	0.001	J	0.008	J	CL-59-01-WS5	3 / 195	0.004 - 0.12	0.1	CCME, Dutch target value	NO	BSL
67-64-1	Acetone	0.004	J	0.55	NJ	CL-59-01-WE4	47 / 195	0.004 - 0.12	2.5	Region 5 - Ecological Screening Value	NO	BSL
71-43-2	Benzene	0.001	J	0.0058	J	SB59-17	8 / 195	0.004 - 0.12	0.1	Region III BTAG - soil fauna	NO	BSL
75-15-0	Carbon disulfide	0.001	J	0.004	J	SB59-4	6 / 195	0.004 - 0.12	0.094	Region 5 - Ecological Screening Value	NO	BSL
110-82-7	Cyclohexane	0.001	J	0.003	J	WS-59-04-010-5	8 / 98	0.004 - 0.023	NA		NO	IDL
100-41-4	Ethyl benzene	0.0023	J	0.11	J	TP59-13A-1	4 / 195	0.004 - 0.023	0.1	Region III BTAG - soil fauna	NO	IDL
	Meta/Para Xylene	0.0051	J	0.0084		WS-59-03-001-2	3 / 70	0.0054 - 0.006	0.1	Region III BTAG - soil fauna for Xylene	NO	BSL
79-20-9	Methyl Acetate	0.001	J	0.002	J	CL-59-OTHERB-WE1	3 / 98	0.004 - 0.023	NA		NO	IDL
74-87-3	Methyl chloride	0.003	J	0.003	J	TP59-5	1 / 125	0.004 - 0.12	10.4	Region 5 - Ecological Screening Value	NO	BSL
108-87-2	Methyl cyclohexane	0.001	J	0.005	J	WS-59-04-010-5	10 / 98	0.004 - 0.023	NA		NO	IDL
78-93-3	Methyl ethyl ketone	0.002	J	0.19	J	CL-59-01-WE4	24 / 195	0.004 - 0.12	35	Dutch - Indicative Level	NO	BSL
108-10-1	Methyl isobutyl ketone	0.0019	J	0.0019	J	CL-59-OTHERC-WS1	1 / 195	0.004 - 0.12	100	Region III BTAG - soil fauna	NO	BSL
75-09-2	Methylene chloride	0.001	J	0.0049	J	WS-59-01-018-1	37 / 196	0.004 - 0.12	0.3	Region III BTAG - soil fauna	NO	BSL
95-47-6	Ortho Xylene	0.0011	NJ	0.0036	J	FD-59-WS-01/WS-59-03-001-3	3 / 70	0.0054 - 0.006	0.1	Region III BTAG - soil fauna for Xylene	NO	BSL
127-18-4	Tetrachloroethene	0.002	J	0.0064		WS-59-01-017-1	5 / 195	0.004 - 0.12	0.3	Region III BTAG - soil fauna	NO	BSL
108-88-3	Toluene	0.0009	J	0.011	J	SB59-17	17 / 195	0.004 - 0.12	0.1	Region III BTAG - soil fauna	NO	BSL
	Total BTEX	0.0025		0.0095		TP59-13C-1	14 / 16	0 - 1.25	NA		NO	ICE
133-02-07	Total Xylenes	0.001	J	0.073	J	SB59-17	8 / 120	0.004 - 0.12	0.1	Region III BTAG - soil fauna for Xylene	NO	BSL
79-01-6	Trichloroethene	0.001	J	0.0045	J	WS-59-01-006-4	8 / 195	0.004 - 0.12	0.3	Region III BTAG - soil fauna	NO	BSL
75-69-4	Trichlorofluoromethane	0.006	J	0.006	J	WS-59-04-010-6	1 / 98	0.004 - 0.023	16.4	Region 5 - Ecological Screening Value	NO	BSL
SVOC												
92-52-4	1,1'-Biphenyl	0.059	NJ	0.15	J	FD-59-W5-6/WS-59-01-012-1	2 / 99	0.35 - 1.9	60	Oak Ridge - Effects on Terrestrial Plants 1997 Rev, Table 1	NO	BSL
91-57-6	2-Methylnaphthalene	0.01	J	10		TP59-13A-1	43 / 196	0.066 - 4	3.24	Region 5 - Ecological Screening Value	YES	ASL
106-47-8	4-Chloroaniline	0.13	J	1.2		CL-59-01-WN2	2 / 196	0.066 - 8	1.1	Region 5 - Ecological Screening Value	NO	IDL
106-44-5	4-Methylphenol	0.024	NJ	0.15	J	CL-59-01-WN5	6 / 196	0.066 - 8	0.1	Region III BTAG - soil fauna	NO	IDL
83-32-9	Acenaphthene	0.0061	J	2.68	J	FD-59-WS-07/WS-59-01-015-13	51 / 196	0.066 - 4	20	Oak Ridge - Effects on Terrestrial Plants 1997 Rev, Table 1	YES	IBC
208-96-8	Acenaphthylene	0.0079	J	1.7	J	WS-59-01-006-11	74 / 196	0.066 - 8	0.1	Region III BTAG - soil fauna	YES	ASL
120-12-7	Anthracene	0.0084	J	4.395	J	FD-59-WS-07/WS-59-01-015-13	85 / 196	0.066 - 8	0.1	Region III BTAG - soil fauna	YES	ASL
1912-24-9	Atrazine	0.12	J	0.12	J	CL-59-01-WN2	1 / 99	0.35 - 1.9	NA		NO	IDL
100-52-7	Benzaldehyde	0.05	J	0.05	J	CL-59-01-WE4	1 / 99	0.35 - 1.9	NA		NO	IDL
56-55-3	Benzo(a)anthracene	0.0038	J	8.9	J	FD-59-WS-07/WS-59-01-015-13	102 / 196	0.069 - 8	0.1	Region III BTAG - soil fauna	YES	ASL

Table J-1B
OCCURRENCE, DISTRIBUTION AND SELECTION OF CHEMICALS OF POTENTIAL CONCERN IN SEAD-59 SOIL (0-4 FT BGS.)
SEAD-59 AND SEAD-71 PHASE II RI
Seneca Army Depot Activity

CAS Number	Chemical	Minimum Detected Concentration ¹ (mg/kg)	Q	Maximum Detected Concentration ¹ (mg/kg)	Q	Location of Maximum Concentration	Detection Frequency ¹	Range of Reporting Limits ¹ (mg/kg)	Screening Value (mg/kg)	Source of Screening Value ²	COPC Flag	Rationale for Contaminant Deletion or Selection ³
50-32-8	Benzo(a)pyrene	0.0036	J	8.05	J	FD-59-WS-07/WS-59-01-015-13	103 / 196	0.069 - 8	0.1	Region III BTAG - soil fauna	YES	ASL
205-99-2	Benzo(b)fluoranthene	0.0038	J	6.8	J	FD-59-WS-07/WS-59-01-015-13	106 / 196	0.078 - 8	0.1	Region III BTAG - soil fauna	YES	ASL
191-24-2	Benzo(ghi)perylene	0.0063	J	5.2	J	FD-59-WS-07/WS-59-01-015-13	93 / 196	0.069 - 8	0.1	Region III BTAG - soil fauna	YES	ASL
207-08-9	Benzo(k)fluoranthene	0.0037	J	7.35	J	FD-59-WS-07/WS-59-01-015-13	99 / 196	0.069 - 8	0.1	Region III BTAG - soil fauna	YES	ASL
117-81-7	Bis(2-Ethylhexyl)phthalate	0.007	J	0.52	J	SB59-1	47 / 196	0.35 - 8	0.925	Region 5 - Ecological Screening Value	NO	BSL
85-68-7	Butylbenzylphthalate	0.0042	J	1	J	TP59-15-5	2 / 196	0.066 - 8	0.239	Region 5 - Ecological Screening Value	NO	IDL
86-74-8	Carbazole	0.0066	J	0.755	J	SB59-1	29 / 126	0.069 - 8	NA		YES	NSV
218-01-9	Chrysene	0.0048	J	8.9	J	FD-59-WS-07/WS-59-01-015-13	104 / 196	0.069 - 8	0.1	Region III BTAG - soil fauna	YES	ASL
53-70-3	Dibenz(a,h)anthracene	0.0047	J	1.665	J	FD-59-WS-07/WS-59-01-015-13	75 / 196	0.066 - 8	0.1	Region III BTAG - soil fauna	YES	ASL
132-64-9	Dibenzofuran	0.0056	J	1.875	J	FD-59-WS-07/WS-59-01-015-13	36 / 196	0.066 - 4	NA		YES	NSV
84-66-2	Diethylphthalate	0.0053	J	0.012	J	SB59-9	9 / 196	0.078 - 8	100	Oak Ridge - Effects on Terrestrial Plants 1997 Rev, Table 1	NO	BSL
84-74-2	Di-n-butylphthalate	0.0048	J	0.49	J	SB59-1	12 / 196	0.076 - 8	200	Oak Ridge - Effects on Terrestrial Plants 1997 Rev, Table 1	NO	BSL
117-84-0	Di-n-octylphthalate	0.0056	J	0.011	J	SB59-8	2 / 196	0.066 - 8	NA		NO	IDL
206-44-0	Fluoranthene	0.0048	J	23.5	J	FD-59-WS-07/WS-59-01-015-13	110 / 196	0.069 - 8	0.1	Region III BTAG - soil fauna	YES	ASL
86-73-7	Fluorene	0.0086	J	3	J	TP59-13A-1	57 / 196	0.066 - 4	30	Oak Ridge - Benchmark concentrations for earthworms, Table 1	YES	IBC
193-39-5	Indeno(1,2,3-cd)pyrene	0.006	J	4.95	J	FD-59-WS-07/WS-59-01-015-13	95 / 196	0.069 - 8	0.1	Region III BTAG - soil fauna	YES	ASL
91-20-3	Naphthalene	0.01	J	1.325	J	FD-59-WS-07/WS-59-01-015-13	41 / 196	0.066 - 8	0.1	Region III BTAG - soil fauna	YES	ASL
86-30-6	N-Nitrosodiphenylamine	0.1	J	0.1	J	CL-59-01-WN2	1 / 126	0.066 - 8	20	Oak Ridge - Benchmark concentrations for earthworms, Table 1	NO	BSL
85-01-8	Phenanthrene	0.0046	J	21.3	J	FD-59-WS-07/WS-59-01-015-13	104 / 196	0.069 - 0.46	0.1	Region III BTAG - soil fauna	YES	ASL
129-00-0	Pyrene	0.0051	J	19.2	J	FD-59-WS-07/WS-59-01-015-13	111 / 195	0.069 - 8	0.1	Region III BTAG - soil fauna	YES	ASL
PCB												
11096-82-5	Aroclor-1260	0.077		0.079	NJ	CL-59-OTHERC-WE2	2 / 196	0.035 - 0.42	0.1	Region III BTAG - soil flora	NO	IDL
Pesticides												
72-54-8	4,4'-DDD	0.0025	J	0.74	J	CL-59-01-WN2	53 / 196	0.0034 - 0.099	0.1	Region III BTAG - soil fauna	YES	ASL
72-55-9	4,4'-DDE	0.0018	J	2.6	J	CL-59-01-WN2	73 / 196	0.0034 - 0.099	0.1	Region III BTAG - soil fauna	YES	ASL
50-29-3	4,4'-DDT	0.0024	J	3.7	J	CL-59-01-WN2	64 / 196	0.0034 - 0.099	0.1	Region III BTAG - soil fauna	YES	ASL
309-00-2	Aldrin	0.0012	J	0.0012	J	SB59-2	1 / 196	0.0018 - 0.22	0.1	Region III BTAG - soil fauna	NO	BSL
319-84-6	Alpha-BHC	0.009		0.0099	J	MW59-4	2 / 196	0.0018 - 0.22	0.0994	Region 5 - Ecological Screening Value	NO	BSL
5103-71-9	Alpha-Chlordane	0.0011	J	0.034	J	WS-59-04-010-10	9 / 196	0.0018 - 0.22	0.1	Region III BTAG for chlordane	NO	BSL
319-85-7	Beta-BHC	0.0024	J	0.0036	J	SB59-8	5 / 196	0.0018 - 0.22	0.00398	Region 5 - Ecological Screening Value	NO	BSL
319-86-8	Delta-BHC	0.0011	J	0.0014	J	SB59-8	3 / 196	0.0018 - 0.22	9.94	Region 5 - Ecological Screening Value	NO	BSL
60-57-1	Dieldrin	0.0018	J	0.0018	J	TP59-8-2	1 / 196	0.0034 - 0.43	0.00003	USEPA 2005 mammalian	NO	IDL

**Table J-1B
 OCCURRENCE, DISTRIBUTION AND SELECTION OF CHEMICALS OF POTENTIAL CONCERN IN SEAD-59 SOIL (0-4 FT BGS.)
 SEAD-59 AND SEAD-71 PHASE II RI
 Seneca Army Depot Activity**

CAS Number	Chemical	Minimum Detected Concentration ¹ (mg/kg)	Q	Maximum Detected Concentration ¹ (mg/kg)	Q	Location of Maximum Concentration	Detection Frequency ¹	Range of Reporting Limits ¹ (mg/kg)	Screening Value (mg/kg)	Source of Screening Value ²	COPC Flag	Rationale for Contaminant Deletion or Selection ³
959-98-8	Endosulfan I	0.0041	J	0.016	J	SB59-2	2 / 196	0.0018 - 0.22	0.119	Region 5 - Ecological Screening Value	NO	BSL
1031-07-8	Endosulfan sulfate	0.0062	J	0.0062	J	CL-59-OTHERC-WE2	1 / 196	0.0034 - 0.43	0.0358	Region 5 - Ecological Screening Value	NO	BSL
72-20-8	Endrin	0.0038	NJ	0.016	NJ	CL-59-04-FO1	4 / 196	0.0034 - 0.43	0.1	Region III BTAG - soil fauna	NO	BSL
7421-93-4	Endrin aldehyde	0.0035	J	0.0039	J	SB59-1	4 / 196	0.0034 - 0.43	0.0105	Region 5 - Ecological Screening Value	NO	IDL
53494-70-5	Endrin ketone	0.0033	J	0.038		WS-59-01-011-3	5 / 196	0.0034 - 0.43	NA		NO	IDL
5103-74-2	Gamma-Chlordane	0.001	J	0.024	J	WS-59-04-010-10	16 / 196	0.0018 - 0.22	0.1	Region III BTAG for chlordane	NO	BSL
1024-57-3	Heptachlor epoxide	0.001	J	0.003	J	TP59-9-2	3 / 196	0.0018 - 0.22	0.1	Region III BTAG - soil fauna	NO	BSL
Metals												
7429-90-5	Aluminum	4,200		18,300	J	CL-59-01-F12	196 / 196		NA		NO	NPH
7440-36-0	Antimony	0.24	J	424	J	SB59-4	106 / 196	0.14 - 3.62	0.27	USEPA, 2005, mammalian	YES	ASL
7440-38-2	Arsenic	2.3	J	32.2	J	CL-59-01-WN2	196 / 196		18	USEPA, 2005, plants	YES	IBC
7440-39-3	Barium	21.1	J	304		SB59-4	196 / 196		330	USEPA, 2005, soil invertebrates	NO	BSL
7440-41-7	Beryllium	0.11	J	2.6		CL-59-01-WN2	194 / 196	0.05 - 0.045	21	USEPA, 2005, mammalian	NO	BSL
7440-43-9	Cadmium	0.1	J	3.2		SB59-4	157 / 196	0.07 - 0.15	0.36	USEPA, 2005, mammalian	YES	ASL
7440-70-2	Calcium	1,350	J	214,000		SB59-4	196 / 196		NA		NO	NUT
7440-47-3	Chromium	7.4	J	39.3	J	CL-59-01-WN2	196 / 196		26	USEPA, 2005, avian, Cr (IV)	YES	ASL
7440-48-4	Cobalt	3.8	J	47.8		CL-59-01-WN2	196 / 196		13	USEPA, 2005, plants	YES	ASL
7440-50-8	Copper	9.8	J	305		WS-59-01-013-5	196 / 196		61	USEPA, 2003, soil invertebrates	YES	ASL
7439-89-6	Iron	6,540		64,000	J	CL-59-01-WN2	196 / 196		NA		NO	NPH
7439-92-1	Lead	4.1	J	164		WS-59-01-006-8	196 / 196		11	USEPA, 2005, avian	YES	ASL
7439-95-4	Magnesium	2,530		34,400		SB59-5	196 / 196		4,400	Region III BTAG, 1995	NO	NUT
7439-96-5	Manganese	156	J	1290	J	CL-59-01-WS6	196 / 196		100	Oak Ridge - microorganisms and microbial process	YES	ASL
7439-97-6	Mercury	0.02	J	0.95	J	WS-59-04-010-6	177 / 195	0.02 - 0.03	0.1	Oak Ridge - Benchmark concentrations for earthworms, Table 1	YES	ASL
7440-02-0	Nickel	9	J	88.3	J	CL-59-01-WN2	196 / 196		30	Oak Ridge - Effects on Terrestrial Plants 1997 Rev, Table 1	YES	ASL
7440-09-7	Potassium	539	J	2,520	J	SB59-1	196 / 196		NA		NO	NUT
7782-49-2	Selenium	0.28	J	1.5		SB59-21	21 / 196	0.26 - 0.58	1	Oak Ridge - Effects on Terrestrial Plants 1997 Rev, Table 1	YES	ASL
7440-22-4	Silver	0.11	J	2.9		CL-59-OTHERA-WN1	88 / 196	0.08 - 0.31	2	Oak Ridge - Effects on Terrestrial Plants 1997 Rev, Table 1	YES	ASL
7440-23-5	Sodium	33.3	J	4,060	J	CL-59-01-WE5	191 / 196	83.1 - 57.5	NA		NO	NUT
7440-28-0	Thallium	0.11		1.8	J	CL-59-03-WS3	51 / 196	0.18 - 0.75	1	Oak Ridge - Effects on Terrestrial Plants 1997 Rev, Table 1	YES	ASL
7440-62-2	Vanadium	8.4	J	28.5	J	CL-59-01-F12	196 / 196		2	Oak Ridge - Effects on Terrestrial Plants 1997 Rev, Table 1	YES	ASL
7440-66-6	Zinc	19.6	J	341		SB59-4	196 / 196		120	USEPA, 2000, soil invertebrates	YES	ASL

**Table J-1B
 OCCURRENCE, DISTRIBUTION AND SELECTION OF CHEMICALS OF POTENTIAL CONCERN IN SEAD-59 SOIL (0-4 FT BGS.)
 SEAD-59 AND SEAD-71 PHASE II RI
 Seneca Army Depot Activity**

CAS Number	Chemical	Minimum Detected Concentration ₁ (mg/kg)	Q	Maximum Detected Concentration ₁ (mg/kg)	Q	Location of Maximum Concentration	Detection Frequency ¹	Range of Reporting Limits ¹ (mg/kg)	Screening Value (mg/kg)	Source of Screening Value ²	COPC Flag	Rationale for Contaminant Deletion or Selection ³
------------	----------	--	---	--	---	-----------------------------------	----------------------------------	---	----------------------------	--	-----------	--

Notes:

- Field duplicates were treated as discrete samples. Lab duplicates were not included in the assessment.
 Range of reporting limits were presented for nondetects only. The maximum detected concentration was used for screening.
- Source of Screening Values:
 - USEPA Ecological Soil Screen Levels, 2000, 2003, 2005
 - USEPA Region III BTAG Screen levels
 - USEPA Region 5 Ecological Soil Screening Levels, December 2003
 - Oak Ridge, R.A. Efrogmson, G.W. Suter II, B.E. Sample, and D.S. Jones, *Preliminary Remediation Goals for Ecological Endpoints* , August 1997
 - Toxicological Benchmarks for Contaminants of Potential Concern for Effects on Soil and Litter Invertebrates and Heterotrophic Process* , 1997 Revision
 - Toxicological Benchmarks for Screening Contaminants of Potential Concern for Effects on terrestrial Plants* , 1997 Revisions
 - CCME - Canadian Environmental Quality Guidelines, December 2003
 - Dutch, *Annexes Circular on target values and intervention values for soil remediation* , February 2000
- Rationale codes
 - Selection Reason:
 - Above Screening Levels (ASL)
 - No Screening Value (NSV)
 - Important Bioaccumulative Compounds (IBC)
 - Deletion Reason:
 - Essential Nutrient (NUT)
 - Below Screening Level (BSL)
 - Infrequent Detection with Low Concentrations (IDL)
 - Individual Chemicals Evaluated (ICE)
 - Neutral pH Value Expected for Soil (NPH)
- Definitions:
 - COPC = Chemical of Potential Concern
 - Q = Qualifier
 - J = Estimated Value
 - NJ = Presence of the analyte has been "tentatively identified" and the associated numerical value represents its approximate concentration.

**Table J-2
 OCCURRENCE, DISTRIBUTION AND SELECTION OF CHEMICALS OF POTENTIAL CONCERN IN SEAD-59 STOCKPILE SOIL
 SEAD-59 AND SEAD-71 PHASE II RI
 Seneca Army Depot Activity**

CAS Number	Chemical	Minimum Detected Concentration ¹ (mg/kg)	Q	Maximum Detected Concentration ¹ (mg/kg)	Q	Location of Maximum Concentration	Detection Frequency ¹	Range of Reporting Limits ¹ (mg/kg)	Concentration Used for Screening (mg/kg)	Screening Value (mg/kg)	Source of Screening Value ²	COPC Flag	Rationale for Contaminant Deletion or Selection ³
VOC													
76-13-1	1,1,2-Trichloro-1,2,2-Trifluoroethane	0.0015	J	0.0015	J	WS-59-01-016-13	1 / 53	0.005 - 0.006	0.0015	NA		NO	IDL
75-35-4	1,1-Dichloroethene	0.001	J	0.001	J	WS-59-01-011-1	1 / 53	0.005 - 0.006	0.001	0.1	CCME, Dutch - target value	NO	BSL
67-64-1	Acetone	0.0048	J	0.069	NJ	WS-59-01-012-2	13 / 53	0.005 - 0.025	0.069	2.5	Region 5 - Ecological Screening Value	NO	BSL
	Meta/Para Xylene	0.0022	J	0.0023	J	WS-59-01-007-13	2 / 48	0.0055 - 0.006	0.0023	0.1	Region III BTAG - soil fauna for Xylene	NO	BSL
78-93-3	Methyl ethyl ketone	0.0026	J	0.007	J	WS-59-01-012-2	5 / 53	0.005 - 0.012	0.007	35	Dutch - Indicative Level	NO	BSL
75-09-2	Methylene chloride	0.0021	J	0.0021	J	FD-59-WS-03/WS-59-01-006-12	1 / 53	0.005 - 0.006	0.0021	0.3	Region III BTAG - soil fauna	NO	BSL
95-47-6	Ortho Xylene	0.001	J	0.0019	J	WS-59-01-016-10	5 / 48	0.0055 - 0.006	0.0019	0.1	Region III BTAG - soil fauna for Xylene	NO	BSL
127-18-4	Tetrachloroethene	0.0053	J	0.0067	J	WS-59-01-016-20	3 / 53	0.005 - 0.006	0.0067	0.3	Region III BTAG - soil fauna	NO	BSL
1330-20-7	Total Xylenes	0.003	J	0.003	J	WS-59-01-011-1	1 / 5	0.005 - 0.006	0.003	0.1	Region III BTAG - soil fauna for Xylene	NO	BSL
79-01-6	Trichloroethene	0.0011	J	0.0028	J	FD-59-WS-03/WS-59-01-006-12	4 / 53	0.005 - 0.006	0.0028	0.3	Region III BTAG - soil fauna	NO	BSL
SVOC													
92-52-4	1,1'-Biphenyl	0.059	J	0.059	J	WS-59-01-012-2	1 / 5	0.37 - 1.9	0.059	60	Oak Ridge - Effects on Terrestrial Plants 1997 Rev, Table 1	NO	BSL
91-57-6	2-Methylnaphthalene	0.039	J	1.2	J	WS-59-01-007-1	27 / 53	0.37 - 3.8	1.2	3.24	Region 5 - Ecological Screening Value	NO	BSL
83-32-9	Acenaphthene	0.046	J	2.4	J	WS-59-01-016-9	46 / 53	0.37 - 1.9	2.4	20	Oak Ridge - Effects on Terrestrial Plants 1997 Rev, Table 1	NO	BSL
208-96-8	Acenaphthylene	0.097	J	3.5	J	WS-59-01-007-14	52 / 53	0.37 - 0.37	3.5	0.1	Region III BTAG - soil fauna	YES	ASL
120-12-7	Anthracene	0.11	J	6.6	J	WS-59-01-007-14	53 / 53		6.6	0.1	Region III BTAG - soil fauna	YES	ASL
56-55-3	Benzo(a)anthracene	0.086	NJ	14	J	WS-59-01-011-7	53 / 53		14	0.1	Region III BTAG - soil fauna	YES	ASL
50-32-8	Benzo(a)pyrene	0.085	J	16	J	WS-59-01-011-7	53 / 53		16	0.1	Region III BTAG - soil fauna	YES	ASL
205-99-2	Benzo(b)fluoranthene	0.11	J	11	J	WS-59-01-011-7	53 / 53		11	0.1	Region III BTAG - soil fauna	YES	ASL
191-24-2	Benzo(ghi)perylene	0.052	J	8	J	WS-59-01-011-7	53 / 53		8	0.1	Region III BTAG - soil fauna	YES	ASL
207-08-9	Benzo(k)fluoranthene	0.048	J	13	J	WS-59-01-011-7	53 / 53		13	0.1	Region III BTAG - soil fauna	YES	ASL
117-81-7	Bis(2-Ethylhexyl)phthalate	0.097	J	0.13	NJ	WS-59-01-012-2	3 / 53	0.38 - 3.8	0.13	0.925	Region 5 - Ecological Screening Value	NO	BSL
86-74-8	Carbazole	0.042	J	1.1	J	WS-59-01-011-1	4 / 5	0.37 - 0.37	1.1	NA		YES	NSV
218-01-9	Chrysene	0.087	J	13	J	WS-59-01-007-14	53 / 53		13	0.1	Region III BTAG - soil fauna	YES	ASL
53-70-3	Dibenz(a,h)anthracene	0.073	J	2.9	J	WS-59-01-012-3	52 / 53	0.37 - 0.37	2.9	0.1	Region III BTAG - soil fauna	YES	ASL
132-64-9	Dibenzofuran	0.19	J	1.3	J	WS-59-01-016-9	33 / 53	0.37 - 3.8	1.3	NA		YES	NSV
206-44-0	Fluoranthene	0.17	J	29	J	WS-59-01-007-14	53 / 53		29	0.1	Region III BTAG - soil fauna	YES	ASL
86-73-7	Fluorene	0.051	NJ	3.1	J	WS-59-01-016-9	47 / 53	0.37 - 1.9	3.1	30	Oak Ridge - Benchmark concentrations for earthworms, Table 1	YES	IBC

**Table J-2
OCCURRENCE, DISTRIBUTION AND SELECTION OF CHEMICALS OF POTENTIAL CONCERN IN SEAD-59 STOCKPILE SOIL
SEAD-59 AND SEAD-71 PHASE II RI
Seneca Army Depot Activity**

CAS Number	Chemical	Minimum Detected Concentration ¹ (mg/kg)	Q	Maximum Detected Concentration ¹ (mg/kg)	Q	Location of Maximum Concentration	Detection Frequency ¹	Range of Reporting Limits ¹ (mg/kg)	Concentration Used for Screening (mg/kg)	Screening Value (mg/kg)	Source of Screening Value ²	COPC Flag	Rationale for Contaminant Deletion or Selection ³
193-39-5	Indeno(1,2,3-cd)pyrene	0.055	J	8	J	WS-59-01-011-7	53 / 53		8	0.1	Region III BTAG - soil fauna	YES	ASL
91-20-3	Naphthalene	0.046	J	1.2	J	WS-59-01-007-13	33 / 53	0.37 - 3.8	1.2	0.1	Region III BTAG - soil fauna	YES	ASL
87-86-5	Pentachlorophenol	0.66	J	0.66	J	WS-59-01-014-5	1 / 53	0.93 - 20	0.66	0.1	Region III BTAG - soil fauna	NO	IDL
85-01-8	Phenanthrene	0.12	J	17	J	WS-59-01-007-14	53 / 53		17	0.1	Region III BTAG - soil fauna	YES	ASL
129-00-0	Pyrene	0.16	J	22	J	WS-59-01-012-3	53 / 53		22	0.1	Region III BTAG - soil fauna	YES	ASL
Pesticide													
72-54-8	4,4'-DDD	0.006		0.45		WS-59-01-015-14	33 / 53	0.019 - 0.098	0.45	0.1	Region III BTAG - soil fauna	YES	ASL
72-55-9	4,4'-DDE	0.0024	J	0.23	J	WS-59-01-006-9	33 / 53	0.018 - 0.098	0.23	0.1	Region III BTAG - soil fauna	YES	ASL
50-29-3	4,4'-DDT	0.0061	J	0.52	J	WS-59-01-015-14	37 / 53	0.019 - 0.098	0.52	0.1	Region III BTAG - soil fauna	YES	ASL
319-84-6	Alpha-BHC	0.0044		0.0044		WS-59-01-011-2	1 / 53	0.0019 - 0.051	0.0044	0.0994	Region 5 - Ecological Screening Value	NO	BSL
5103-71-9	Alpha-Chlordane	0.0034		0.027	J	WS-59-01-011-8	6 / 53	0.002 - 0.051	0.027	0.1	Region III BTAG for chlordane	NO	BSL
319-85-7	Beta-BHC	0.013	NJ	0.013	NJ	WS-59-01-014-5	1 / 53	0.0019 - 0.051	0.013	0.00398	Region 5 - Ecological Screening Value	NO	IDL
53494-70-5	Endrin ketone	0.015	J	0.015	J	WS-59-01-011-2	1 / 53	0.0037 - 0.098	0.015	NA		NO	IDL
58-89-9	Gamma-Chlordane	0.0079		0.021	J	WS-59-01-005-5	5 / 53	0.0019 - 0.051	0.021	0.1	Region III BTAG for chlordane	NO	BSL
Metals													
7429-90-5	Aluminum	6,830	J	13,400	J	WS-59-01-005-5	53 / 53		13,400	NA		NO	NPH
7440-36-0	Antimony	0.96	J	43.9	J	WS-59-01-015-14	11 / 53	1.6 - 1.8	43.9	0.27	USEPA, 2005, mammalian	YES	ASL
7440-38-2	Arsenic	3.6	J	7.3	J	WS-59-01-014-5	53 / 53		7.3	18	USEPA, 2005, plants	YES	ASL
7440-39-3	Barium	53.6		135		WS-59-01-015-14	53 / 53		135	330	USEPA, 2005, soil invertebrates	NO	BSL
7440-41-7	Beryllium	0.14	J	0.69	J	WS-59-01-005-4	53 / 53		0.69	21	USEPA, 2005, mammalian	NO	BSL
7440-43-9	Cadmium	0.29	J	1.2	J	WS-59-01-016-5	52 / 53	0.14 - 0.14	1.2	0.36	USEPA, 2005, mammalian	YES	ASL
7440-70-2	Calcium	17,500		100,000		WS-59-01-016-20	53 / 53		100,000	NA		NO	NUT
7440-47-3	Chromium	11.4	J	35	J	WS-59-01-016-18	53 / 53		35	26	USEPA, 2005, avian, Cr (IV)	YES	ASL
7440-48-4	Cobalt	6.1	J	13.9	J	WS-59-01-006-9	53 / 53		13.9	13	USEPA, 2003, plants	YES	ASL
7440-50-8	Copper	18.4	J	51.8	J	WS-59-01-016-18	53 / 53		51.8	61	USEPA, 2003, soil invertebrates	YES	IBC
7439-89-6	Iron	14,900		26,500		WS-59-01-008-2	53 / 53		26,500	NA		NO	NPH
7439-92-1	Lead	15.4	J	1,440	J	WS-59-01-016-10	53 / 53		1,440	11	USEPA, 2005, avian	YES	ASL
7439-95-4	Magnesium	4,890		26,600	J	WS-59-01-008-3	53 / 53		26,600	4,400	Region III BTAG, 1995	NO	NUT
7439-96-5	Manganese	321	J	1,220	J	WS-59-01-016-5	53 / 53		1,220	100	Oak Ridge - microorganisms and microbial process	YES	ASL
7439-97-6	Mercury	0.04		0.52	J	WS-59-04-010-8	53 / 53		0.52	0.1	Oak Ridge - Benchmark concentrations for earthworms, Table 1	YES	ASL
7440-02-0	Nickel	19.1	J	56.6	J	WS-59-01-007-12	53 / 53		56.6	30	Oak Ridge - Effects on Terrestrial Plants 1997 Rev, Table 1	YES	ASL
7440-09-7	Potassium	781		1,580	J	WS-59-01-011-1	53 / 53		1,580	NA		NO	NUT
7782-49-2	Selenium	0.69	J	0.72	J	WS-59-01-013-2	2 / 53	0.135 - 0.6	0.72	1	Oak Ridge - Effects on Terrestrial Plants 1997 Rev, Table 1	YES	IBC

**Table J-2
OCCURRENCE, DISTRIBUTION AND SELECTION OF CHEMICALS OF POTENTIAL CONCERN IN SEAD-59 STOCKPILE SOIL
SEAD-59 AND SEAD-71 PHASE II RI
Seneca Army Depot Activity**

CAS Number	Chemical	Minimum Detected Concentration ¹ (mg/kg)	Q	Maximum Detected Concentration ¹ (mg/kg)	Q	Location of Maximum Concentration	Detection Frequency ¹	Range of Reporting Limits ¹ (mg/kg)	Concentration Used for Screening (mg/kg)	Screening Value (mg/kg)	Source of Screening Value ²	COPC Flag	Rationale for Contaminant Deletion or Selection ³
7440-22-4	Silver	0.56		4.7		WS-59-01-016-18	9 / 53	0.055 - 0.305	4.7	2	Oak Ridge - Effects on Terrestrial Plants 1997 Rev, Table 1	YES	ASL
7440-23-5	Sodium	68.5		525		WS-59-01-016-4	53 / 53		525	NA		NO	NUT
7440-28-0	Thallium	0.56	J	0.99	J	WS-59-01-015-16	27 / 53	0.095 - 0.295	0.99	1	Oak Ridge - Effects on Terrestrial Plants 1997 Rev, Table 1	NO	BSL
7440-62-2	Vanadium	13.4		35.4		WS-59-01-007-10	53 / 53		35.4	2	Oak Ridge - Effects on Terrestrial Plants 1997 Rev, Table 1	YES	ASL
7440-66-6	Zinc	57	J	185	J	WS-59-01-006-9	53 / 53		185	120	USEPA, 2000, soil invertebrates	YES	ASL

Notes:

1. Field duplicates were treated as discrete samples. Lab duplicates were not included in the assessment.

Range of reporting limits were presented for nondetects only. The maximum detected concentration was used for screening.

2. Source of Screening Values:

USEPA Ecological Soil Screen Levels, 2000, 2003, 2005

USEPA Region III BTAG Screen levels

USEPA Region 5 Ecological Soil Screening Levels, December 2003

Oak Ridge, R.A. Efrogmson, G.W. Suter II, B.E. Sample, and D.S. Jones, *Preliminary Remediation Goals for Ecological Endpoints*, August 1997

Toxicological Benchmarks for Contaminants of Potential Concern for Effects on Soil and Litter Invertebrates and Heterotrophic Process, 1997 Revision

Toxicological Benchmarks for Screening Contaminants of Potential Concern for Effects on terrestrial Plants, 1997 Revisions

CCME - Canadian Environmental Quality Guidelines, December 2003

Dutch, *Annexes Circular on target values and intervention values for soil remediation*, February 2000

3. Rationale codes

Selection Reason: Above Screening Levels (ASL)
No Screening Value (NSV)
Important Bioaccumulative Compounds (IBC)

Deletion Reason: Essential Nutrient (NUT)
Below Screening Level (BSL)
Infrequent Detection with Low Concentrations (IDL)
Individual Chemicals Evaluated (ICE)
Neutral pH Value Expected for Soil (NPH)

Definitions:

COPC = Chemical of Potential Concern

Q = Qualifier

J = Estimated Value

NJ = Presence of the analyte has t

**Table J-3A
 OCCURRENCE, DISTRIBUTION AND SELECTION OF CHEMICALS OF POTENTIAL CONCERN IN SEAD-71 SOIL 0-2 FT
 SEAD-59 AND SEAD-71 PHASE II RI
 Seneca Army Depot Activity**

CAS Number	Chemical	Units	Minimum Detected Concentration ¹ (mg/kg)	Q	Maximum Detected Concentration ¹ (mg/kg)	Q	Location of Maximum Concentration	Detection Frequency ¹	Range of Reporting Limits ¹ (mg/kg)	Concentration Used for Screening (mg/kg)	Screening Value (mg/kg)	Source of Screening Value ²	COPC Flag	Rationale for Contaminant Deletion or Selection ³
VOC														
71-55-6	1,1,1-Trichloroethane	UG/KG	0.002	NJ	0.003	J	TP71-2	2 / 68	0.005 - 0.018	0.003	0.1	Canada EQG - Soil Agri	NO	BSL
67-64-1	Acetone	UG/KG	0.004	NJ	0.074		SS71-14	9 / 68	0.005 - 0.024	0.074	2.5	Region 5 - Ecological Screening Value	NO	BSL
71-43-2	Benzene	UG/KG	0.001	J	0.002	J	SS71-1	2 / 68	0.005 - 0.018	0.002	0.1	Region III BTAG - soil fauna	NO	BSL
75-15-0	Carbon disulfide	UG/KG	0.002	J	0.005	J	CL-71-B-WN1	3 / 68	0.005 - 0.018	0.005	0.094	Region 5 - Ecological Screening Value	NO	BSL
110-82-7	Cyclohexane	UG/KG	0.003	J	0.004	J	WS-71-A-009-9	2 / 23	0.005 - 0.006	0.004	NA		NO	IDL
100-41-4	Ethyl benzene	UG/KG	0.004	J	0.004	J	SS71-13	2 / 68	0.005 - 0.015	0.004	0.1	Region III BTAG - soil fauna	NO	BSL
108-87-2	Methyl cyclohexane	UG/KG	0.003	J	0.006		WS-71-A-009-9	3 / 23	0.005 - 0.006	0.006	NA		NO	IDL
75-09-2	Methylene chloride	UG/KG	0.001	J	0.011	J	TP71-2	8 / 68	0.005 - 0.018	0.011	0.3	Region III BTAG - soil fauna	NO	BSL
100-42-5	Styrene	UG/KG	0.001	J	0.001	J	SS71-20	1 / 47	0.005 - 0.018	0.001	0.1	Region III BTAG - soil fauna	NO	BSL
127-18-4	Tetrachloroethene	UG/KG	0.033		0.033		SS71-16	1 / 68	0.005 - 0.018	0.033	0.3	Region III BTAG - soil fauna	NO	BSL
108-88-3	Toluene	UG/KG	0.001	J	0.016		SS71-17	11 / 68	0.005 - 0.015	0.016	0.1	Region III BTAG - soil fauna	NO	BSL
	Total BTEX	MG/KG	11.6		11.6		TP71-3-1	1 / 1		11.6	NA		NO	ICE
1330-20-7	Total Xylenes	UG/KG	0.002	J	0.011	J	SS71-13	5 / 44	0.005 - 0.015	0.011	0.1	Region III BTAG - soil fauna for Xylene	NO	BSL
75-69-4	Trichlorofluoromethane	UG/KG	0.001	J	0.001	J	WS-71-B-009-6	1 / 23	0.005 - 0.006	0.001	16.4	Region 5 - Ecological Screening Value	NO	BSL
SVOC														
121-14-2	2,4-Dinitrotoluene	UG/KG	0.88	J	0.88	J	WS-71-D-009-13	1 / 69	0.066 - 72	0.88	NA		NO	IDL
91-57-6	2-Methylnaphthalene	UG/KG	0.0086	J	19	J	SS71-13	15 / 69	0.34 - 39	19	3.24	Region 5 - Ecological Screening Value	YES	ASL
100-01-6	4-Nitroaniline	UG/KG	0.075	J	0.075	J	WS-71-B-009-6	1 / 47	0.16 - 180	0.075	NA		NO	IDL
83-32-9	Acenaphthene	UG/KG	0.0055	J	42	J	SS71-13	29 / 69	0.3 - 5.5	42	20	Oak Ridge - Effects on Terrestrial Plants 1997 Rev, Table 1	YES	ASL
208-96-8	Acenaphthylene	UG/KG	0.02	J	1.8		CL-71-C-WN1	19 / 69	0.066 - 72	1.8	0.1	Region III BTAG - soil fauna	YES	ASL
120-12-7	Anthracene	UG/KG	0.012	J	100		SS71-11	41 / 69	0.35 - 5.5	100	0.1	Region III BTAG - soil fauna	YES	ASL
56-55-3	Benzo(a)anthracene	UG/KG	0.032	J	150		SS71-11	53 / 69	0.35 - 1.9	150	0.1	Region III BTAG - soil fauna	YES	ASL
50-32-8	Benzo(a)pyrene	UG/KG	0.037	J	120		SS71-11	53 / 69	0.066 - 1.9	120	0.1	Region III BTAG - soil fauna	YES	ASL
205-99-2	Benzo(b)fluoranthene	UG/KG	0.04	J	88		SS71-11	54 / 69	0.066 - 1.9	88	0.1	Region III BTAG - soil fauna	YES	ASL
191-24-2	Benzo(ghi)perylene	UG/KG	0.036	J	62	J	SS71-11	48 / 69	0.066 - 1.9	62	0.1	Region III BTAG - soil fauna	YES	ASL
207-08-9	Benzo(k)fluoranthene	UG/KG	0.077	J	130		SS71-11	42 / 69	0.066 - 1.9	130	0.1	Region III BTAG - soil fauna	YES	ASL
117-81-7	Bis(2-Ethylhexyl)phthalate	UG/KG	0.039	J	0.14	J	WS-71-D-009-13	6 / 69	0.066 - 72	0.14	0.925	Region 5 - Ecological Screening Value	NO	BSL
86-74-8	Carbazole	UG/KG	0.015	J	77		SS71-13	27 / 47	0.34 - 1.5	77	NA		YES	NSV
218-01-9	Chrysene	UG/KG	0.043	J	150		SS71-11	56 / 69	0.35 - 1.9	150	0.1	Region III BTAG - soil fauna	YES	ASL

**Table J-3A
 OCCURRENCE, DISTRIBUTION AND SELECTION OF CHEMICALS OF POTENTIAL CONCERN IN SEAD-71 SOIL 0-2 FT
 SEAD-59 AND SEAD-71 PHASE II RI
 Seneca Army Depot Activity**

CAS Number	Chemical	Units	Minimum Detected Concentration ¹ (mg/kg)	Q	Maximum Detected Concentration ¹ (mg/kg)	Q	Location of Maximum Concentration	Detection Frequency ¹	Range of Reporting Limits ¹ (mg/kg)	Concentration Used for Screening (mg/kg)	Screening Value (mg/kg)	Source of Screening Value ²	COPC Flag	Rationale for Contaminant Deletion or Selection ³
84-74-2	Di-n-butylphthalate	UG/KG	0.0064	J	0.14	J	SS71-19	4 / 69	0.066 - 72	0.14	200	Oak Ridge - Effects on Terrestrial Plants 1997 Rev, Table 1	NO	BSL
53-70-3	Dibenz(a,h)anthracene	UG/KG	0.029	J	25	J	SS71-11	40 / 69	0.066 - 5.5	25	0.1	Region III BTAG - soil fauna	YES	ASL
132-64-9	Dibenzofuran	UG/KG	0.013	J	38	J	SS71-13	27 / 69	0.08 - 5.5	38	NA		YES	NSV
206-44-0	Fluoranthene	UG/KG	0.05	J	440		SS71-11	58 / 69	0.35 - 0.4	440	0.1	Region III BTAG - soil fauna	YES	ASL
86-73-7	Fluorene	UG/KG	0.0047	J	62	J	SS71-13	28 / 69	0.3 - 5.5	62	30	Oak Ridge - Benchmark concentrations for earthworms, Table 1	YES	ASL
193-39-5	Indeno(1,2,3-cd)pyrene	UG/KG	0.039	J	65	J	SS71-11	48 / 69	0.066 - 1.9	65	0.1	Region III BTAG - soil fauna	YES	ASL
91-20-3	Naphthalene	UG/KG	0.01	J	46	J	SS71-13	15 / 69	0.093 - 39	46	0.1	Region III BTAG - soil fauna	YES	ASL
85-01-8	Phenanthrene	UG/KG	0.03	J	290		SS71-13	54 / 69	0.35 - 1.9	290	0.1	Region III BTAG - soil fauna	YES	ASL
108-95-2	Phenol	UG/KG	0.0045	J	0.0045	J	TP71-3-1	1 / 69	0.08 - 72	0.0045	30	Oak Ridge - Benchmark concentrations for earthworms, Table 1	NO	BSL
129-00-0	Pyrene	UG/KG	0.043	J	280		SS71-11	56 / 69	0.35 - 1.9	280	0.1	Region III BTAG - soil fauna	YES	ASL
Pesticide														
72-54-8	4,4'-DDD	UG/KG	0.0028	J	0.24		SS71-17	18 / 69	0.0035 - 0.04	0.24	0.1	Region III BTAG - soil fauna	YES	ASL
72-55-9	4,4'-DDE	UG/KG	0.0068	J	0.81		SS71-17	29 / 69	0.0034 - 0.038	0.81	0.1	Region III BTAG - soil fauna	YES	ASL
50-29-3	4,4'-DDT	UG/KG	0.0027	J	1.3		SS71-16	35 / 69	0.0034 - 0.038	1.3	0.1	Region III BTAG - soil fauna	YES	ASL
319-84-6	Alpha-BHC	UG/KG	0.0012	J	0.014	J	SS71-5	5 / 69	0.0018 - 0.022	0.014	0.0994	Region 5 - Ecological Screening Value	NO	BSL
5103-71-9	Alpha-Chlordane	UG/KG	0.002	J	0.002	J	TP71-2	1 / 69	0.0018 - 0.022	0.002	0.1	Region III BTAG for chlordane	NO	BSL
319-85-7	Beta-BHC	UG/KG	0.0019		0.035		SS71-17	6 / 69	0.0018 - 0.022	0.035	0.00398	Region 5 - Ecological Screening Value	NO	BSL
60-57-1	Dieldrin	UG/KG	0.003	J	0.0034	J	SS71-14	2 / 69	0.0034 - 0.042	0.000032	0.00028	USEPA 2005 mammalian	NO	IDL
959-98-8	Endosulfan I	UG/KG	0.0015	J	0.015	J	SS71-11	7 / 69	0.0018 - 0.022	0.015	0.119	Region 5 - Ecological Screening Value	NO	IDL
33213-65-9	Endosulfan II	UG/KG	0.002	J	0.052		SS71-15	3 / 69	0.0034 - 0.042	0.052	0.119	Region 5 - Ecological Screening Value	NO	BSL
1031-07-8	Endosulfan sulfate	UG/KG	0.0022	J	0.11		SS71-13	11 / 69	0.0034 - 0.04	0.11	0.0358	Region 5 - Ecological Screening Value	YES	ASL
72-20-8	Endrin	UG/KG	0.0024	J	0.12		SS71-16	10 / 69	0.0034 - 0.042	0.12	0.1	Region III BTAG - soil fauna	YES	ASL
7421-93-4	Endrin aldehyde	UG/KG	0.004		0.12		SS71-6	16 / 69	0.0034 - 0.04	0.12	0.005	Region 5 - Ecological Screening Value	YES	ASL
53494-70-5	Endrin ketone	UG/KG	0.0064		0.18		SS71-17	15 / 69	0.0034 - 0.04	0.18	NA		YES	NSV
5103-74-2	Gamma-Chlordane	UG/KG	0.0012	J	0.048		SS71-17	4 / 69	0.0018 - 0.022	0.048	0.1	Region III BTAG for chlordane	NO	BSL
1024-57-3	Heptachlor epoxide	UG/KG	0.0015	J	0.18		SS71-17	12 / 69	0.0018 - 0.021	0.18	0.1	Region III BTAG - soil fauna	YES	ASL
72-43-5	Methoxychlor	UG/KG	0.011	J	0.52		SS71-5	11 / 69	0.018 - 0.22	0.52	0.1	Region III BTAG - soil fauna	YES	ASL
PCB														

**Table J-3A
 OCCURRENCE, DISTRIBUTION AND SELECTION OF CHEMICALS OF POTENTIAL CONCERN IN SEAD-71 SOIL 0-2 FT
 SEAD-59 AND SEAD-71 PHASE II RI
 Seneca Army Depot Activity**

CAS Number	Chemical	Units	Minimum Detected Concentration ¹ (mg/kg)	Q	Maximum Detected Concentration ¹ (mg/kg)	Q	Location of Maximum Concentration	Detection Frequency ¹	Range of Reporting Limits ¹ (mg/kg)	Concentration Used for Screening (mg/kg)	Screening Value (mg/kg)	Source of Screening Value ²	COPC Flag	Rationale for Contaminant Deletion or Selection ³
11096-82-5	Aroclor-1260	UG/KG	0.08		0.2	J	CL-71-B-WE2	3 / 69	0.035 - 0.42	0.2	0.1	Region III BTAG - soil flora	NO	IDL
Metals														
7429-90-5	Aluminum	MG/KG	1,710		18,000		TP71-2	69 / 69		18,000	NA		NO	NPH
7440-36-0	Antimony	MG/KG	0.21	J	19.3	J	SS71-16	34 / 69	0.18 - 3.6	19.3	0.27	USEPA, 2005, mammalian	YES	ASL
7440-38-2	Arsenic	MG/KG	2.1		14.6		SS71-9	69 / 69		14.6	18	USEPA, 2005, plants	YES	ASL
7440-39-3	Barium	MG/KG	20.9	J	179	J	SS71-16	69 / 69		179	330	USEPA, 2005, soil invertebrates	NO	BSL
7440-41-7	Beryllium	MG/KG	0.05		0.88	J	TP71-2	68 / 69	0.02 - 0.02	0.88	21	USEPA, 2005, mammalian	NO	BSL
7440-43-9	Cadmium	MG/KG	0.17	J	12.1	J	SS71-15	46 / 69	0.05 - 1.1	12.1	0.36	USEPA, 2005, mammalian	YES	ASL
7440-70-2	Calcium	MG/KG	4,260	J	295,000		SS71-14	69 / 69		295,000	NA		NO	NUT
7440-47-3	Chromium	MG/KG	4.2	J	60.3	J	SS71-19	69 / 69		60.3	26	USEPA, 2005, avian, Cr (IV)	YES	ASL
7440-48-4	Cobalt	MG/KG	3.3		14.6		TP71-2	69 / 69		14.6	13	USEPA, 2003, plants	YES	ASL
7440-50-8	Copper	MG/KG	5.4	J	134	J	SS71-16	69 / 69		134	61	USEPA, 2003, soil invertebrates	YES	ASL
7439-89-6	Iron	MG/KG	5,990		65,100		SS71-5	69 / 69		65,100	NA		NO	NPH
7439-92-1	Lead	MG/KG	7.4	J	3,470	J	SS71-16	69 / 69		3,470	11	USEPA, 2005, avian	YES	ASL
7439-95-4	Magnesium	MG/KG	3,800		59,300		SS71-14	69 / 69		59,300	4,400	Region III BTAG, 1995	NO	NUT
7439-96-5	Manganese	MG/KG	202	J	1,330		CL-71-E3-WS1	69 / 69		1,330	100	Oak Ridge - microorganisms and microbial process	YES	ASL
7439-97-6	Mercury	MG/KG	0.02	J	2.7	J	SS71-16	55 / 69	0.05 - 0.07	2.7	0.1	Oak Ridge - Benchmark concentrations for earthworms, Table 1	YES	ASL
7440-02-0	Nickel	MG/KG	8.7		110		SS71-10	69 / 69		110	30	Oak Ridge - Effects on Terrestrial Plants 1997 Rev, Table 1	YES	ASL
7440-09-7	Potassium	MG/KG	671		2,180		SS71-9	69 / 69		2,180	NA		NO	NUT
7782-49-2	Selenium	MG/KG	0.61	J	1.8	J	SS71-10	13 / 69	0.37 - 1.1	1.8	1	Oak Ridge - Effects on Terrestrial Plants 1997 Rev, Table 1	YES	ASL
7440-22-4	Silver	MG/KG	0.32	J	2.2	J	SS71-11	27 / 69	0.06 - 0.67	2.2	2	Oak Ridge - Effects on Terrestrial Plants 1997 Rev, Table 1	YES	ASL
7440-23-5	Sodium	MG/KG	33.2	J	1,040		SS71-5	67 / 69	17.6 - 83.3	1,040	NA		NO	NUT
7440-28-0	Thallium	MG/KG	0.57	J	2.3		SS71-9	18 / 69	0.19 - 1.7	2.3	1	Oak Ridge - Effects on Terrestrial Plants 1997 Rev, Table 1	YES	ASL
7440-62-2	Vanadium	MG/KG	6.9		29.2		TP71-2	69 / 69		29.2	2	Oak Ridge - Effects on Terrestrial Plants 1997 Rev, Table 1	YES	ASL

**Table J-3A
OCCURRENCE, DISTRIBUTION AND SELECTION OF CHEMICALS OF POTENTIAL CONCERN IN SEAD-71 SOIL 0-2 FT
SEAD-59 AND SEAD-71 PHASE II RI
Seneca Army Depot Activity**

CAS Number	Chemical	Units	Minimum Detected Concentration ¹ (mg/kg)	Q	Maximum Detected Concentration ¹ (mg/kg)	Q	Location of Maximum Concentration	Detection Frequency ¹	Range of Reporting Limits ¹ (mg/kg)	Concentration Used for Screening (mg/kg)	Screening Value (mg/kg)	Source of Screening Value ²	COPC Flag	Rationale for Contaminant Deletion or Selection ³
7440-66-6	Zinc	MG/KG	43.4	J	3,660	J	SS71-5	68 / 69	352 - 352	3,660	120	USEPA, 2000, soil invertebrates	YES	ASL

Notes:

1. Field duplicates were treated as discrete samples. Lab duplicates were not included in the assessment.

Range of reporting limits were presented for nondetects only. The maximum detected concentration was used for screening.

2. Source of Screening Values:

USEPA Ecological Soil Screen Levels, 2000, 2003, 2005

USEPA Region III BTAG Screen levels

USEPA Region 5 Ecological Soil Screening Levels, December 2003

Oak Ridge, R.A. Efroymson, G.W. Suter II, B.E. Sample, and D.S. Jones, *Preliminary Remediation Goals for Ecological Endpoints*, August 1997

Toxicological Benchmarks for Contaminants of Potential Concern for Effects on Soil and Litter Invertebrates and Heterotrophic Process, 1997 Revision

Toxicological Benchmarks for Screening Contaminants of Potential Concern for Effects on terrestrial Plants, 1997 Revisions

CCME - Canadian Environmental Quality Guidelines, December 2003

Dutch, *Annexes Circular on target values and intervention values for soil remediation*, February 2000

3. Rationale codes

Selection Reason: Above Screening Levels (ASL)
No Screening Value (NSV)

Deletion Reason: Essential Nutrient (NUT)
Below Screening Level (BSL)
Infrequent Detection with Low Concentrations (IDL)
Individual Chemicals Evaluated (ICE)
Neutral pH Value Expected for Soil (NPH)

Definitions:

COPC = Chemical of Potential Concern

Q = Qualifier

J = Estimated Value

NJ = Presence of the analyte has been "tentatively identified" and the associated numerical value represents its approximate concentration.

Table J-3B
OCCURRENCE, DISTRIBUTION AND SELECTION OF CHEMICALS OF POTENTIAL CONCERN IN SEAD-71 SOIL 0-4 FT
SEAD-59 AND SEAD-71 PHASE II RI
Seneca Army Depot Activity

CAS Number	Chemical	Minimum Detected Concentration ¹ (mg/kg)	Q	Maximum Detected Concentration ¹ (mg/kg)	Q	Location of Maximum Concentration	Detection Frequency ¹	Range of Reporting Limits ¹ (mg/kg)	Screening Value (mg/kg)	Source of Screening Value ²	COPC Flag	Rationale for Contaminant Deletion or Selection ³
VOC												
71-55-6	1,1,1-Trichloroethane	0.002	NJ	0.023		TP71-1	6 / 72	0.005 - 0.018	0.1	Canada EQG - Soil Agri	NO	BSL
67-64-1	Acetone	0.004	NJ	0.074		SS71-14	9 / 72	0.005 - 0.024	2.5	Region 5 - Ecological Screening Value	NO	BSL
71-43-2	Benzene	0.001	J	0.002	J	SS71-1	2 / 72	0.005 - 0.018	0.1	Region III BTAG - soil fauna	NO	BSL
75-15-0	Carbon disulfide	0.002	J	0.005	J	CL-71-B-WN1	3 / 72	0.005 - 0.018	0.094	Region 5 - Ecological Screening Value	NO	BSL
110-82-7	Cyclohexane	0.003	J	0.004	J	WS-71-A-009-9	2 / 23	0.005 - 0.006	NA		NO	IDL
100-41-4	Ethyl benzene	0.004	J	0.004	J	SS71-13	2 / 72	0.005 - 0.015	0.1	Region III BTAG - soil fauna	NO	BSL
108-87-2	Methyl cyclohexane	0.003	J	0.006		WS-71-A-009-9	3 / 23	0.005 - 0.006	NA		NO	IDL
75-09-2	Methylene chloride	0.001	J	0.011	J	TP71-2	12 / 72	0.005 - 0.018	0.3	Region III BTAG - soil fauna	NO	BSL
100-42-5	Styrene	0.001	J	0.001	J	SS71-20	1 / 51	0.005 - 0.018	0.1	Region III BTAG - soil fauna	NO	BSL
127-18-4	Tetrachloroethene	0.001	J	0.033		SS71-16	4 / 72	0.005 - 0.018	0.3	Region III BTAG - soil fauna	NO	BSL
108-88-3	Toluene	0.001	J	0.016		SS71-17	11 / 72	0.005 - 0.015	0.1	Region III BTAG - soil fauna	NO	BSL
	Total BTEX	11.6		11.6		TP71-3-1	1 / 1		NA		NO	ICE
1330-20-7	Total Xylenes	0.002	J	0.011	J	SS71-13	5 / 48	0.005 - 0.015	0.1	Region III BTAG - soil fauna for Xylene	NO	BSL
75-69-4	Trichlorofluoromethane	0.001	J	0.001	J	WS-71-B-009-6	1 / 23	0.005 - 0.006	16.4	Region 5 - Ecological Screening Value	NO	BSL
SVOC												
121-14-2	2,4-Dinitrotoluene	0.88	J	0.88	J	WS-71-D-009-13	1 / 73	0.066 - 72	NA		NO	IDL
91-57-6	2-Methylnaphthalene	0.0086	J	19	J	SS71-13	16 / 73	0.34 - 39	3.24	Region 5 - Ecological Screening Value	YES	ASL
100-01-6	4-Nitroaniline	0.075	J	0.075	J	WS-71-B-009-6	1 / 51	0.16 - 180	NA		NO	IDL
83-32-9	Acenaphthene	0.0055	J	42	J	SS71-13	33 / 73	0.3 - 5.5	20	Oak Ridge - Effects on Terrestrial Plants 1997 Rev, Table 1	YES	ASL
208-96-8	Acenaphthylene	0.02	J	1.8		CL-71-C-WN1	19 / 73	0.066 - 72	0.1	Region III BTAG - soil fauna	YES	ASL
120-12-7	Anthracene	0.012	J	100		SS71-11	45 / 73	0.35 - 5.5	0.1	Region III BTAG - soil fauna	YES	ASL
56-55-3	Benzo(a)anthracene	0.032	J	150		SS71-11	57 / 73	0.35 - 1.9	0.1	Region III BTAG - soil fauna	YES	ASL
50-32-8	Benzo(a)pyrene	0.037	J	120		SS71-11	57 / 73	0.066 - 1.9	0.1	Region III BTAG - soil fauna	YES	ASL
205-99-2	Benzo(b)fluoranthene	0.04	J	88		SS71-11	58 / 73	0.066 - 1.9	0.1	Region III BTAG - soil fauna	YES	ASL
191-24-2	Benzo(ghi)perylene	0.036	J	62	J	SS71-11	52 / 73	0.066 - 1.9	0.1	Region III BTAG - soil fauna	YES	ASL
207-08-9	Benzo(k)fluoranthene	0.077	J	130		SS71-11	46 / 73	0.066 - 1.9	0.1	Region III BTAG - soil fauna	YES	ASL
117-81-7	Bis(2-Ethylhexyl)phthalate	0.039	J	0.14	J	WS-71-D-009-13	6 / 73	0.066 - 72	0.925	Region 5 - Ecological Screening Value	NO	BSL
86-74-8	Carbazole	0.015	J	77		SS71-13	31 / 51	0.34 - 1.5	NA		YES	NSV
218-01-9	Chrysene	0.043	J	150		SS71-11	60 / 73	0.35 - 1.9	0.1	Region III BTAG - soil fauna	YES	ASL
84-74-2	Di-n-butylphthalate	0.0064	J	0.14	J	SS71-19	4 / 73	0.066 - 72	200	Oak Ridge - Effects on Terrestrial Plants 1997 Rev, Table 1	NO	BSL
53-70-3	Dibenzo(a,h)anthracene	0.029	J	25	J	SS71-11	44 / 73	0.066 - 5.5	0.1	Region III BTAG - soil fauna	YES	ASL
132-64-9	Dibenzofuran	0.013	J	38	J	SS71-13	28 / 73	0.08 - 19	NA		YES	NSV
206-44-0	Fluoranthene	0.05	J	440		SS71-11	62 / 73	0.35 - 0.4	0.1	Region III BTAG - soil fauna	YES	ASL
86-73-7	Fluorene	0.0047	J	62	J	SS71-13	31 / 73	0.3 - 5.5	30	Oak Ridge - Benchmark concentrations for earthworms, Table 1	YES	ASL
193-39-5	Indeno(1,2,3-cd)pyrene	0.039	J	65	J	SS71-11	52 / 73	0.066 - 1.9	0.1	Region III BTAG - soil fauna	YES	ASL
91-20-3	Naphthalene	0.01	J	46	J	SS71-13	17 / 73	0.093 - 39	0.1	Region III BTAG - soil fauna	YES	ASL

Table J-3B
OCCURRENCE, DISTRIBUTION AND SELECTION OF CHEMICALS OF POTENTIAL CONCERN IN SEAD-71 SOIL 0-4 FT
SEAD-59 AND SEAD-71 PHASE II RI
Seneca Army Depot Activity

CAS Number	Chemical	Minimum Detected Concentration ¹ (mg/kg)	Q	Maximum Detected Concentration ¹ (mg/kg)	Q	Location of Maximum Concentration	Detection Frequency ¹		Range of Reporting Limits ¹ (mg/kg)		Screening Value (mg/kg)	Source of Screening Value ²	COPC Flag	Rationale for Contaminant Deletion or Selection ³
85-01-8	Phenanthrene	0.03	J	290		SS71-13	58 /	73	0.35 -	1.9	0.1	Region III BTAG - soil fauna	YES	ASL
108-95-2	Phenol	0.0045	J	0.0045	J	TP71-3-1	1 /	73	0.08 -	72	30	Oak Ridge - Benchmark concentrations for earthworms, Table 1	NO	BSL
129-00-0	Pyrene	0.043	J	280		SS71-11	60 /	73	0.35 -	1.9	0.1	Region III BTAG - soil fauna	YES	ASL
	Pesticide													
72-54-8	4,4'-DDD	0.0028	J	0.24		SS71-17	18 /	73	0.0035 -	0.04	0.1	Region III BTAG - soil fauna	YES	ASL
72-55-9	4,4'-DDE	0.0031	J	0.81		SS71-17	31 /	73	0.0034 -	0.038	0.1	Region III BTAG - soil fauna	YES	ASL
50-29-3	4,4'-DDT	0.0027	J	1.3		SS71-16	37 /	73	0.0034 -	0.038	0.1	Region III BTAG - soil fauna	YES	ASL
319-84-6	Alpha-BHC	0.0012	J	0.014	J	SS71-5	5 /	73	0.0018 -	0.022	0.0994	Region 5 - Ecological Screening Value	NO	BSL
5103-71-9	Alpha-Chlordane	0.002	J	0.074	J	TP71-1	2 /	73	0.0018 -	0.022	0.1	Region III BTAG for chlordane	NO	BSL
319-85-7	Beta-BHC	0.0019		0.035		SS71-17	6 /	73	0.0018 -	0.022	0.00398	Region 5 - Ecological Screening Value	NO	IDL
60-57-1	Dieldrin	0.003	J	0.0035	J	TP71-1	3 /	73	0.0034 -	0.042	0.00003	USEPA 2005 mammalian	NO	IDL
959-98-8	Endosulfan I	0.0015	J	0.2	J	TP71-1	11 /	73	0.0018 -	0.022	0.119	Region 5 - Ecological Screening Value	YES	ASL
33213-65-9	Endosulfan II	0.002	J	0.052		SS71-15	5 /	73	0.0034 -	0.042	0.119	Region 5 - Ecological Screening Value	NO	BSL
1031-07-8	Endosulfan sulfate	0.0022	J	0.11		SS71-13	11 /	73	0.0034 -	0.04	0.0358	Region 5 - Ecological Screening Value	YES	ASL
72-20-8	Endrin	0.0024	J	0.12		SS71-16	11 /	73	0.0034 -	0.042	0.1	Region III BTAG - soil fauna	YES	ASL
7421-93-4	Endrin aldehyde	0.004		0.12		SS71-6	16 /	73	0.0034 -	0.04	0.0105	Region 5 - Ecological Screening Value	YES	ASL
53494-70-5	Endrin ketone	0.0064		0.18		SS71-17	15 /	73	0.0034 -	0.04	NA		YES	NSV
5103-74-2	Gamma-Chlordane	0.0012	J	0.048		SS71-17	4 /	73	0.0018 -	0.022	0.1	Region III BTAG for chlordane	NO	BSL
76-44-8	Heptachlor	0.0012	J	0.0012	J	TP71-1	1 /	73	0.0018 -	0.022	0.0007	Dutch - target value	NO	IDL
1024-57-3	Heptachlor epoxide	0.0015	J	0.18		SS71-17	12 /	73	0.0018 -	0.021	0.1	Region III BTAG - soil fauna	YES	ASL
72-43-5	Methoxychlor	0.011	J	0.52		SS71-5	11 /	73	0.018 -	0.22	0.1	Region III BTAG - soil fauna	YES	ASL
	PCB													
11096-82-5	Aroclor-1260	0.08		0.2	J	CL-71-B-WE2	3 /	73	0.035 -	0.42	0.1	Region III BTAG - soil flora	NO	IDL
	Metals													
7429-90-5	Aluminum	1,710		18,000		TP71-2	73 /	73			NA		NO	NPH
7440-36-0	Antimony	0.19	J	19.3	J	SS71-16	36 /	73	0.18 -	3.6	0.27	USEPA, 2005, mammalian	YES	ASL
7440-38-2	Arsenic	2.1		14.6		SS71-9	73 /	73			18	USEPA, 2005, plants	YES	IBC
7440-39-3	Barium	20.9	J	179	J	SS71-16	73 /	73			330	USEPA, 2005, soil invertebrates	NO	BSL
7440-41-7	Beryllium	0.05		0.88	J	TP71-2	72 /	73	0.02 -	0.02	21	USEPA, 2005, mammalian	NO	BSL
7440-43-9	Cadmium	0.17	J	12.1	J	SS71-15	50 /	73	0.05 -	1.1	0.36	USEPA, 2005, mammalian	YES	ASL
7440-70-2	Calcium	4,260	J	295,000		SS71-14	73 /	73			NA		NO	NUT
7440-47-3	Chromium	4.2	J	60.3	J	SS71-19	73 /	73			26	USEPA, 2005, avian, Cr (IV)	YES	ASL
7440-48-4	Cobalt	3.3		14.6		TP71-2	73 /	73			13	USEPA, 2003, plants	YES	ASL
7440-50-8	Copper	5.4	J	134	J	SS71-16	73 /	73			61	USEPA, 2003, soil invertebrates	YES	ASL
7439-89-6	Iron	5,990		65,100		SS71-5	73 /	73			NA		NO	NPH
7439-92-1	Lead	7.4	J	3,470	J	SS71-16	73 /	73			11	USEPA, 2005, avian	YES	ASL
7439-95-4	Magnesium	3,800		59,300		SS71-14	73 /	73			4,400	Region III BTAG, 1995	YES	NUT
7439-96-5	Manganese	202	J	1,330		CL-71-E3-WS1	73 /	73			100	Oak Ridge - microorganisms and microbial process	YES	ASL

**Table J-3B
 OCCURRENCE, DISTRIBUTION AND SELECTION OF CHEMICALS OF POTENTIAL CONCERN IN SEAD-71 SOIL 0-4 FT
 SEAD-59 AND SEAD-71 PHASE II RI
 Seneca Army Depot Activity**

CAS Number	Chemical	Minimum Detected Concentration ¹ (mg/kg)	Q	Maximum Detected Concentration ¹ (mg/kg)	Q	Location of Maximum Concentration	Detection Frequency ¹	Range of Reporting Limits ¹ (mg/kg)	Screening Value (mg/kg)	Source of Screening Value ²	COPC Flag	Rationale for Contaminant Deletion or Selection ³
7439-97-6	Mercury	0.02	J	2.7	J	SS71-16	59 / 73	0.05 - 0.07	0.1	Oak Ridge - Benchmark concentrations for earthworms, Table 1	YES	ASL
7440-02-0	Nickel	8.7		110		SS71-10	73 / 73		30	Oak Ridge - Effects on Terrestrial Plants 1997 Rev, Table 1	YES	ASL
7440-09-7	Potassium	671		2,180		SS71-9	73 / 73		NA		NO	NUT
7782-49-2	Selenium	0.43	J	1.8	J	SS71-10	14 / 73	0.37 - 1.1	1	Oak Ridge - Effects on Terrestrial Plants 1997 Rev, Table 1	YES	ASL
7440-22-4	Silver	0.32	J	2.2	J	SS71-11	27 / 73	0.06 - 0.67	2	Oak Ridge - Effects on Terrestrial Plants 1997 Rev, Table 1	YES	ASL
7440-23-5	Sodium	33.2	J	1,040		SS71-5	71 / 73	17.6 - 83.3	NA		NO	NUT
7440-28-0	Thallium	0.57	J	2.3		SS71-9	18 / 73	0.19 - 1.7	1	Oak Ridge - Effects on Terrestrial Plants 1997 Rev, Table 1	YES	ASL
7440-62-2	Vanadium	6.9		29.2		TP71-2	73 / 73		2	Oak Ridge - Effects on Terrestrial Plants 1997 Rev, Table 1	YES	ASL
7440-66-6	Zinc	43.4	J	3,660	J	SS71-5	72 / 73	352 - 352	120	USEPA, 2000, soil invertebrates	YES	ASL

Notes:

1. Field duplicates were treated as discrete samples. Lab duplicates were not included in the assessment.

Range of reporting limits were presented for nondetects only. The maximum detected concentration was used for screening.

2. Background value is the 95% upper confidence limit of the arithmetic mean of the Seneca background concentrations.

2. Source of Screening Values:

- USEPA Ecological Soil Screen Levels, 2000, 2003, 2005
- USEPA Region III BTAG Screen levels
- USEPA Region 5 Ecological Soil Screening Levels, December 2003
- Oak Ridge, R.A. Efrogmson, G.W. Suter II, B.E. Sample, and D.S. Jones, *Preliminary Remediation Goals for Ecological Endpoints*, August 1997
- Toxicological Benchmarks for Contaminants of Potential Concern for Effects on Soil and Litter Invertebrates and Heterotrophic Process*, 1997 Revision
- Toxicological Benchmarks for Screening Contaminants of Potential Concern for Effects on terrestrial Plants*, 1997 Revisions
- CCME - Canadian Environmental Quality Guidelines, December 2003
- Dutch, *Annexes Circular on target values and intervention values for soil remediation*, February 2000

3. Rationale codes

- Selection Reason: Above Screening Levels (ASL)
- No Screening Value (NSV)
- Deletion Reason: Essential Nutrient (NUT)
- Below Screening Level (BSL)
- Infrequent Detection with Low Concentrations (IDL)
- Individual Chemicals Evaluated (ICE)
- Neutral pH Value Expected for Soil (NPH)

Definitions:

- COPC = Chemical of Potential Concern
- Q = Qualifier
- J = Estimated Value
- NJ = Presence of the analyte has been "tentatively identified" and the associated numerical value represents its approximate concentration.

Table J-4
SEAD-59 and SEAD-71 Phase II RI Report
CONVERSION FACTORS

Category of Uncertainty	Conversion Factor ⁽¹⁾
Study Duration Conversion Factor^(a)	
Chronic studies, equilibrium attained	1
Subchronic studies	10
Subacute studies	10
Acute studies	10
Single dose	10
Unknown	10
Endpoint Conversion Factor (for NOAEL endpoint)	
No-observed-effect level	1
No-observed-adverse-effect level	1
Lowest-observed-effect level	10
Lowest-observed-adverse-effect level	10
Effective concentration lethal to 50 percent of test population	10
Unknown	10
Endpoint Conversion Factor (for LOAEL endpoint)	
No-observed-effect level	0.1
No-observed-adverse-effect level	0.1
Lowest-observed-effect level	1
Lowest-observed-adverse-effect level	1
Effective concentration lethal to 50 percent of test population	10
Unknown	10

SEV = Screening Ecotoxicity Values

NOAEL = No Observed Adverse Effect Level

LOAEL = Lowest Observed Adverse Effect Level

(1) The product of the appropriate conversion factor from each uncertainty category becomes the conversion factor applied to develop the constituent-specific SEV.

(a) For the purposes of the Ecological Screening Level Risk Assessment, the following study duration definitions for terrestrial species were applied:

Chronic - Greater than 90 days (gestation day studies considered chronic exposure).

Subchronic - From 30 to 90 days.

Subacute - From 7 to 29 days.

Acute - Less than 7 days.

TABLE J-5
NOAEL SCREENING ECOTOXICITY VALUES - DEER MOUSE
SEAD-59 and SEAD-71 Phase II RI Report

COPC	Test Organism	Endpoint / Duration / Effect (survival, growth, reproduction)	Source	Effect Dose (mg/kg/day)	Total CF⁽¹⁾	SEV (mg/kg/day)⁽²⁾
Semi-Volatile Organic Compounds						
2-Methylnaphthalene	mouse	LOAEL/diet, 81 wks/respiratory, naphthalene used as surrogate	ATSDR, 1995	71.6	10	7.47E+00
Acenaphthene	mouse	LOAEL/gestation days 7-16 crit. Lifestage/Reproduction, benzo(a)pyrene used as surrogate	Sample et al., 1996	10	10	1.04E+00
Acenaphthylene	mouse	LOAEL/gestation days 7-16 crit. Lifestage/Reproduction, benzo(a)pyrene used as surrogate	Sample et al., 1996	10	10	1.04E+00
Anthracene	mouse	LOAEL/gestation days 7-16 crit. Lifestage/Reproduction, benzo(a)pyrene used as surrogate	Sample et al., 1996	10	10	1.04E+00
Benzo(a)anthracene	mouse	LOAEL/gestation days 7-16 crit. Lifestage/Reproduction, benzo(a)pyrene used as surrogate	Sample et al., 1996	10	10	1.04E+00
Benzo(a)pyrene	mouse	LOAEL/gestation days 7-16 crit. Lifestage/Reproduction	Sample et al., 1996	10	10	1.04E+00
Benzo(b)fluoranthene	mouse	LOAEL/gestation days 7-16 crit. Lifestage/Reproduction, benzo(a)pyrene used as surrogate	Sample et al., 1996	10	10	1.04E+00
Benzo(ghi)perylene	mouse	LOAEL/gestation days 7-16 crit. Lifestage/Reproduction, benzo(a)pyrene used as surrogate	Sample et al., 1996	10	10	1.04E+00
Benzo(k)fluoranthene	mouse	LOAEL/gestation days 7-16 crit. Lifestage/Reproduction, benzo(a)pyrene used as surrogate	Sample et al., 1996	10	10	1.04E+00
Carbazole	rat	LD50/oral	Sax, 1984	500	100	6.05E+00
Chrysene	mouse	LOAEL/gestation days 7-16 crit. Lifestage/Reproduction, benzo(a)pyrene used as surrogate	Sample et al., 1996	10	10	1.04E+00
Dibenz(a,h)anthracene	mouse	LOAEL/gestation days 7-16 crit. Lifestage/Reproduction	Sample et al., 1996	10	10	1.04E+00
Dibenzofuran	mouse	LOAEL/gestation days 7-16 crit. Lifestage/Reproduction, benzo(a)pyrene used as surrogate	Sample et al., 1996	10	10	1.04E+00
Fluoranthene	mouse	LOAEL/13 wks/hepatic effects	ATSDR, 1995	125	10	1.30E+01
Fluorene	mouse	LOAEL/13 wks/hepatic effects	ATSDR, 1995	125	10	1.30E+01

TABLE J-5
NOAEL SCREENING ECOTOXICITY VALUES - DEER MOUSE
SEAD-59 and SEAD-71 Phase II RI Report

COPC	Test Organism	Endpoint / Duration / Effect (survival, growth, reproduction)	Source	Effect Dose (mg/kg/day)	Total CF⁽¹⁾	SEV (mg/kg/day)⁽²⁾
Indeno(1,2,3-cd)pyrene	mouse	LOAEL/gestation days 7-16 crit. Lifestage/Reproduction, benzo(a)pyrene used as surrogate	Sample et al., 1996	10	10	1.04E+00
Naphthalene	mouse	LOAEL/diet, 81 wks/respiratory	ATSDR, 1995	71.6	10	7.47E+00
Phenanthrene	mouse	LOAEL/gestation days 7-16 crit. Lifestage/Reproduction, benzo(a)pyrene used as surrogate	Sample et al., 1996	10	10	1.04E+00
Pyrene	mouse	LOAEL/gestation days 7-16 crit. Lifestage/Reproduction, benzo(a)pyrene used as surrogate	Sample et al., 1996	10	10	1.04E+00
bis(2-Ethylhexyl) phthalate	mouse	NOAEL/over 105 days crit. Lifestage/reporduction	Sample et al., 1996	18.3	1	1.91E+01
Pesticides						
4,4'-DDD	mouse	NOAEL/78 weeks, respiratory, female	ATSDR, 2002	142	1	1.48E+02
4,4'-DDE	rat	NOAEL/5 weeks	USEPA, 1999	10	10	1.21E+00
4,4'-DDT	rat	NOAEL/2 yr reproduction, oral	Sample et al., 1996	0.8	1	9.67E-01
Endosulfan I	rat	NOAEL/30 days, reproduction, blood chemistry, endosulfan used as surrogate	Sample et al., 1996	1.5	10	1.81E-01
Endosulfan sulfate	rat	NOAEL/30 days, reproduction, blood chemistry, endosulfan used as surrogate	Sample et al., 1996	1.5	10	1.81E-01
Endrin	mouse	LOAEL/120 d, reproduction	Sample et al., 1996	0.92	10	9.60E-02
Endrin aldehyde	mouse	LOAEL/120 d, reproduction, endrin used as surrogate	Sample et al., 1996	0.92	10	9.60E-02
Endrin ketone	mouse	LOAEL/120 d, reproduction, endrin used as surrogate	Sample et al., 1996	0.92	10	9.60E-02
Heptachlor epoxide	mink	LOAEL/181 d, reproduction, heptachlor used as a surrogate	Sample et al., 1996	1	10	1.29E-01
Methoxychlor	rat	NOAEL/11 month, reproduction	Sample et al., 1996	4	1	4.84E+00
Inorganics						
Aluminum	mouse	LOAEL/mouse over 3 generations, >1 yr/reproduction	Sample et al., 1996	19.3	10	2.01E+00

TABLE J-5
NOAEL SCREENING ECOTOXICITY VALUES - DEER MOUSE
SEAD-59 and SEAD-71 Phase II RI Report

COPC	Test Organism	Endpoint / Duration / Effect (survival, growth, reproduction)	Source	Effect Dose (mg/kg/day)	Total CF⁽¹⁾	SEV (mg/kg/day)⁽²⁾
Antimony	mouse	LOAEL/lifetime/lifespan, longevity	Sample et al., 1996	1.25	10	1.30E-01
Arsenic	mouse	LOAEL/3 generations >1 yr/reproduction	Sample et al., 1996	1.26	10	1.31E-01
Barium		The geometric mean of the NOAEL values for reproduction and growth	USEPA, 2005	51.8	1	5.18E+01
Beryllium	rat	NOAEL/lifetime/longevity, weight loss	Sample et al., 1996	0.66	1	7.98E-01
Cadmium	rat	NOAEL/6 wks through mating and gestation/reproduction	Sample et al., 1996	1	1	1.21E+00
Chromium	rat	NOAEL/90 d and 2 yr/reproduction, longevity, Cr(III)	Sample et al., 1996	2737	1	3.31E+03
Chromium, Hexavalent	rat	NOAEL/1 yr/body weight and food consumption	Sample et al., 1996	3.28	1	3.97E+00
Cobalt	rabbit	LOAEL/over 2 wks/cardiac, for cobalt sulfate	RTECS, 2004	140	100	1.95E+00
Copper	mink	NOAEL/357 d/reproduction	Sample et al., 1996	11.7	1	1.51E+01
Iron	Child	Based on the dietary reference intake for a child	Marilyn 2001	0.67	1	1.01E+00
Lead	Rat	Reproductive / 3 generations oral / NOAEL	Sample et al. 1996	8	1	9.67E+00
Magnesium	hamster	lowest published toxic dose/30 weeks/tumorigenic, olfaction, lung	RTECS, 2004	480	10	5.41E+01
Manganese	rat	NOAEL/through gestation for 224 day/reproduction	Sample et al. 1996	88	1	1.06E+02
Mercury	mink	NOAEL/1 yr/reproduction, mercuric sulfide	Sample et al. 1996	1.0	1	1.29E+00
Nickel	Rat	Reproduction / 3 generations diet / NOAEL	Sample et al. 1996	40	1	4.84E+01
Selenium	rat	NOAEL/1yr through 2 generations/reproduction	Sample et al. 1996	0.20	1	2.42E-01
Silver	mouse	LOAEL/125 days/hypoactivity	USEPA, 1999	3.75	10	3.91E-01
Thallium	rat	LOAEL/60 days/testicular function	USEPA, 1999	1.31	10	1.58E-01
Tin	mouse	NOAEL/days 6-15 of gestation/reproduction	Sample et al. 1996	23.4	1	2.44E+01
Vanadium	rat	LOAEL/60 d prior to gestation, plus through gestation, delivery, and lactation/reproduction	Sample et al. 1996	2.1	10	2.54E-01

**TABLE J-5
NOAEL SCREENING ECOTOXICITY VALUES - DEER MOUSE
SEAD-59 and SEAD-71 Phase II RI Report**

COPC	Test Organism	Endpoint / Duration / Effect (survival, growth, reproduction)	Source	Effect Dose (mg/kg/day)	Total CF⁽¹⁾	SEV (mg/kg/day)⁽²⁾
Zinc	Rat	Reproduction / day 1-16 of gestation diet / NOAEL	Sample et al. 1996	160	1	1.93E+02

NOAEL = No Observed Adverse Effect Level

COPC = Constituent of Potential Concern

CF = Conversion Factor

SEV = Screening Ecotoxicity Values

(1) For CFs, see Table G-4

(2) SEV = Effective Dose x Scaling Factor / Total CF

Scaling Factors for Toxicity Values:

$$SEV_w = SEV_t * (bw_t / bw_w)^{(1-b)}$$

Where bw is the body weight, and t and w represent the test and wildlife species, respectively, and b is the allometric scaling factor (b=0.94 for mammals, Sample et al., 1999)

From Test Species	To: Deer Mouse	Weight (kg)
Lab Mouse	1.04	0.03
Rat	1.21	0.35
Mink	1.29	1
Rabbit	1.39	3.8
Child	1.51	15
Hamster	1.13	0.11
	Deer Mouse	0.0148

References:

Agency for Toxic Substances and Disease Registry (ATSDR). On-line resources available at <http://www.atsdr.cdc.gov/toxpro2.html>.

Sample et al., 1996. Toxicological Benchmarks for Wildlife: 1996 Revision.

Sax, N.I. 1984. Dangerous Properties of Industrial Chemicals. 6th Ed.

Marilyn et al., 2001. Dietary Reference Intakes.

USEPA. 1999. Screening Level Ecological Risk Assessment Protocol for Hazardous Waste Combustion Facilities. Peer Review Draft. 1999.

Registry of Toxic Effects of Chemical Substances (RTECS). On-line resources available at <http://www.cdc.gov/niosh/rtecs.html>

Sample, B.E., and C.A. Arenal. 1999. Allometric Models for Inter-species Extrapolation of Wildlife Toxicity Data. Bull Environ Contam Toxicol. 62:653-663.

USEPA. 2005. Ecological Soil Screening Levels for Barium.

TABLE J-5
NOAEL SCREENING ECOTOXICITY VALUES - American Robin
SEAD-59 and SEAD-71 Phase II RI Report

COPC	Test Organism	Endpoint / Duration / Effect (survival, growth, reproduction)	Source	Effect Dose (mg/kg/day)	Total CF⁽¹⁾	SEV (mg/kg/day)⁽²⁾
Semi-Volatile Organic Compounds						
2-Methylnaphthalene	mallard	LOAEL/diet 7 months/physiological for mixed PAHs	Eisler, 1987	285	10	2.85E+01
Acenaphthene	mallard	LOAEL/diet 7 months/physiological for mixed PAHs	Eisler, 1987	285	10	2.85E+01
Acenaphthylene	mallard	LOAEL/diet 7 months/physiological for mixed PAHs	Eisler, 1987	285	10	2.85E+01
Anthracene	mallard	LOAEL/diet 7 months/physiological for mixed PAHs	Eisler, 1987	285	10	2.85E+01
Benzo(a)anthracene	mallard	LOAEL/diet 7 months/physiological for mixed PAHs	Eisler, 1987	285	10	2.85E+01
Benzo(a)pyrene	mallard	LOAEL/diet 7 months/physiological for mixed PAHs	Eisler, 1987	285	10	2.85E+01
Benzo(b)fluoranthene	mallard	LOAEL/diet 7 months/physiological for mixed PAHs	Eisler, 1987	285	10	2.85E+01
Benzo(ghi)perylene	mallard	LOAEL/diet 7 months/physiological for mixed PAHs	Eisler, 1987	285	10	2.85E+01
Benzo(k)fluoranthene	mallard	LOAEL/diet 7 months/physiological for mixed PAHs	Eisler, 1987	285	10	2.85E+01
Carbazole	mallard	LOAEL/diet 7 months/physiological for mixed PAHs	Eisler, 1987	285	10	2.85E+01
Chrysene	mallard	LOAEL/diet 7 months/physiological for mixed PAHs	Eisler, 1987	285	10	2.85E+01
Dibenz(a,h)anthracene	mallard	LOAEL/diet 7 months/physiological for mixed PAHs	Eisler, 1987	285	10	2.85E+01
Dibenzofuran	mallard	LOAEL/diet 7 months/physiological for mixed PAHs	Eisler, 1987	285	10	2.85E+01
Fluoranthene	mallard	LOAEL/diet 7 months/physiological for mixed PAHs	Eisler, 1987	285	10	2.85E+01
Fluorene	mallard	LOAEL/diet 7 months/physiological for mixed PAHs	Eisler, 1987	285	10	2.85E+01
Indeno(1,2,3-cd)pyrene	mallard	LOAEL/diet 7 months/physiological for mixed PAHs	Eisler, 1987	285	10	2.85E+01

**TABLE J-5
NOAEL SCREENING ECOTOXICITY VALUES - American Robin
SEAD-59 and SEAD-71 Phase II RI Report**

COPC	Test Organism	Endpoint / Duration / Effect (survival, growth, reproduction)	Source	Effect Dose (mg/kg/day)	Total CF⁽¹⁾	SEV (mg/kg/day)⁽²⁾
Naphthalene	mallard	LOAEL/diet 7 months/physiological for mixed PAHs	Eisler, 1987	285	10	2.85E+01
Phenanthrene	mallard	LOAEL/diet 7 months/physiological for mixed PAHs	Eisler, 1987	285	10	2.85E+01
Pyrene	mallard	LOAEL/diet 7 months/physiological for mixed PAHs	Eisler, 1987	285	10	2.85E+01
bis(2-Ethylhexyl) phthalate	ringed dove	NOAEL/diet, 4 wks crit. Lifestage/reproduction	Sample et al., 1996	1.11	1	1.11E+00
Pesticides						
4,4'-DDD	Coturnix quail	Acute (5 days) LOAEL (mortality), 4,4'-DDE used as surrogate	USEPA, 1999	84.5	100	8.45E-01
4,4'-DDE	Coturnix quail	Acute (5 days) LOAEL (mortality)	USEPA, 1999	84.5	100	8.45E-01
4,4'-DDT	brown pelican	LOAEL/diet, 5 yr, reproduction	Sample et al., 1996	0.028	10	2.80E-03
Endosulfan I	gray partridge	NOAEL/4 weeks critical lifestage, reproduction, endosulfan used as surrogate	Sample et al., 1996	10	1	1.00E+01
Endosulfan sulfate	gray partridge	NOAEL/4 weeks critical lifestage, reproduction, endosulfan used as surrogate	Sample et al., 1996	10	1	1.00E+01
Endrin	mallard duck	NOAEL/>200d, reproduction	Sample et al., 1996	0.3	1	3.00E-01
Endrin aldehyde	mallard duck	NOAEL/>200d, reproduction, endrin used as a surrogate	Sample et al., 1996	0.3	1	3.00E-01
Endrin ketone	mallard duck	NOAEL/>200d, reproduction, endrin used as a surrogate	Sample et al., 1996	0.3	1	3.00E-01
Heptachlor epoxide	quail	LOAEL/5 days, mortality, heptachlor used as a surrogate	USEPA, 1999	6.5	100	6.50E-02
Methoxychlor	northern bobwhite	LD50/14 days, mortality	USEPA Ecotox Database	2510	100	2.51E+01
Inorganics						
Aluminum	ringed dove	NOAEL/4 months/reproduction	Sample et al., 1996	109.7	1	1.10E+02
Antimony		Screening Ecological Value not available				

TABLE J-5
NOAEL SCREENING ECOTOXICITY VALUES - American Robin
SEAD-59 and SEAD-71 Phase II RI Report

COPC	Test Organism	Endpoint / Duration / Effect (survival, growth, reproduction)	Source	Effect Dose (mg/kg/day)	Total CF⁽¹⁾	SEV (mg/kg/day)⁽²⁾
Arsenic	cowbird	NOAEL/7 months/mortality	Sample et al., 1996	2.46	1	2.46E+00
Barium	chick	NOAEL/4 wk/mortality	Sample et al., 1996	208.26	10	2.08E+01
Beryllium	rat	NOAEL/lifetime/longevity, weight loss - toxicity data for rat	Sample et al., 1996	0.66	1	6.60E-01
Cadmium	mallard ducks	NOAEL/90 d/reproduction	Sample et al., 1996	1.45	1	1.45E+00
Chromium	black duck	NOAEL/10 month/reproduction for Cr(III)	Sample et al., 1996	1	1	1.00E+00
Chromium, Hexavalent	black duck	NOAEL/10 month/reproduction for Cr(III)	Sample et al., 1996	1	1	1.00E+00
Cobalt	chicken	Toxic dietary concentration	NRC 1994	100	1	1.00E+02
Copper	chick	NOAEL/10 weeks/growth, mortality	Sample et al., 1996	47	1	4.70E+01
Iron	Chicken	Toxic dietary concentration	NRC, 1994	4500	1	4.50E+03
Lead	American Kestrels	NOAEL/7 months/reproduction	Sample et al. 1996	3.85	1	3.85E+00
Magnesium	chicken	Toxic dietary concentration	NRC, 1994	5700	1	5.70E+03
Manganese	Japanese quail	NOAEL/75 d/growth, aggressive behavior	Sample et al. 1996	977	10	9.77E+01
Mercury	Japanese quail	NOAEL/1 yr/reproduction, mercuric chloride	Sample et al. 1996	0.45	1	4.50E-01
Nickel	mallard duckling	NOAEL/90 d/mortality, growth, behavior	Sample et al. 1996	77.4	1	7.74E+01
Selenium	mallard duck	NOAEL/78 days/reproduction	Sample et al. 1996	0.5	1	5.00E-01
Silver	mallard	NOAEL/14 days	USEPA, 1999	1780	10	1.78E+02
Thallium	wild bird	Lowest lethal dose to wild bird	RTECS, 2004	37	100	3.70E-01
Tin	japanese quail	NOAEL/6 wks/reproduction	Sample et al. 1996	6.8	1	6.80E+00
Vanadium	mallard duck	NOAEL/12 wks/mortality, body weight, blood chemistry	Sample et al. 1996	11.4	1	1.14E+01
Zinc	Leghorn hen and New Hampshire rooster	NOAEL/44 wks	USEPA, 1999	130.9	1	1.31E+02

NOAEL = No Observed Adverse Effect Level

**TABLE J-5
NOAEL SCREENING ECOTOXICITY VALUES - American Robin
SEAD-59 and SEAD-71 Phase II RI Report**

COPC	Test Organism	Endpoint / Duration / Effect (survival, growth, reproduction)	Source	Effect Dose (mg/kg/day)	Total CF ⁽¹⁾	SEV (mg/kg/day) ⁽²⁾
------	---------------	---	--------	-------------------------	-------------------------	--------------------------------

COPC = Constituent of Potential Concern

CF = Conversion Factor

SEV = Screening Ecotoxicity Values

(1) For CFs, see Table G-4

(2) SEV = Effective Dose x Scaling Factor / Total CF

References:

Eisler, R. 1985-1995. Contaminant Hazards Review Series, Biological Report Series, US Fish and Wildlife Service, Patuxent Wildlife Research Center, Laurel, MD.

Sample et al., 1996. Toxicological Benchmarks for Wildlife: 1996 Revision.

USEPA. 1999. Screening Level Ecological Risk Assessment Protocol for Hazardous Waste Combustion Facilities. Peer Review Draft. 1999.

Registry of Toxic Effects of Chemical Substances (RTECS). On-line resources available at <http://www.cdc.gov/niosh/rtecs.html>

National Research Council. 1994. Nutrient Requirements of Poultry.

USEPA. ECOTOX Database. On-line resources available at <http://www.epa.gov/ecotox/>

TABLE J-5
NOAEL SCREENING ECOTOXICITY VALUES - SHORT-TAILED SHREW
SEAD-59 and SEAD-71 Phase II RI Report

COPC	Test Organism	Endpoint / Duration / Effect (survival, growth, reproduction)	Source	Effect Dose (mg/kg/day)	Total CF⁽¹⁾	SEV (mg/kg/day)⁽²⁾
Semi-Volatile Organic Compounds						
2-Methylnaphthalene	mouse	LOAEL/diet, 81 wks/respiratory, naphthalene used as surrogate	ATSDR, 1995	71.6	10	7.46E+00
Acenaphthene	mouse	LOAEL/gestation days 7-16 crit. Lifestage/Reproduction, benzo(a)pyrene used as surrogate	Sample et al., 1996	10	10	1.04E+00
Acenaphthylene	mouse	LOAEL/gestation days 7-16 crit. Lifestage/Reproduction, benzo(a)pyrene used as surrogate	Sample et al., 1996	10	10	1.04E+00
Anthracene	mouse	LOAEL/gestation days 7-16 crit. Lifestage/Reproduction, benzo(a)pyrene used as surrogate	Sample et al., 1996	10	10	1.04E+00
Benzo(a)anthracene	mouse	LOAEL/gestation days 7-16 crit. Lifestage/Reproduction, benzo(a)pyrene used as surrogate	Sample et al., 1996	10	10	1.04E+00
Benzo(a)pyrene	mouse	LOAEL/gestation days 7-16 crit. Lifestage/Reproduction	Sample et al., 1996	10	10	1.04E+00
Benzo(b)fluoranthene	mouse	LOAEL/gestation days 7-16 crit. Lifestage/Reproduction, benzo(a)pyrene used as surrogate	Sample et al., 1996	10	10	1.04E+00
Benzo(ghi)perylene	mouse	LOAEL/gestation days 7-16 crit. Lifestage/Reproduction, benzo(a)pyrene used as surrogate	Sample et al., 1996	10	10	1.04E+00
Benzo(k)fluoranthene	mouse	LOAEL/gestation days 7-16 crit. Lifestage/Reproduction, benzo(a)pyrene used as surrogate	Sample et al., 1996	10	10	1.04E+00
Carbazole	rat	LD50/oral	Sax, 1984	500	100	6.04E+00
Chrysene	mouse	LOAEL/gestation days 7-16 crit. Lifestage/Reproduction, benzo(a)pyrene used as surrogate	Sample et al., 1996	10	10	1.04E+00
Dibenz(a,h)anthracene	mouse	LOAEL/gestation days 7-16 crit. Lifestage/Reproduction, benzo(a)pyrene used as surrogate	Sample et al., 1996	10	10	1.04E+00
Dibenzofuran	mouse	LOAEL/gestation days 7-16 crit. Lifestage/Reproduction, benzo(a)pyrene used as surrogate	Sample et al., 1996	10	10	1.04E+00
Fluoranthene	mouse	LOAEL/13 wks/hepatic effects	ATSDR, 1995	125	10	1.30E+01

TABLE J-5
NOAEL SCREENING ECOTOXICITY VALUES - SHORT-TAILED SHREW
SEAD-59 and SEAD-71 Phase II RI Report

COPC	Test Organism	Endpoint / Duration / Effect (survival, growth, reproduction)	Source	Effect Dose (mg/kg/day)	Total CF⁽¹⁾	SEV (mg/kg/day)⁽²⁾
Fluorene	mouse	LOAEL/13 wks/hepatic effects	ATSDR, 1995	125	10	1.30E+01
Indeno(1,2,3-cd)pyrene	mouse	LOAEL/gestation days 7-16 crit. Lifestage/Reproduction, benzo(a)pyrene used as surrogate	Sample et al., 1996	10	10	1.04E+00
Naphthalene	mouse	LOAEL/diet, 81 wks/respiratory	ATSDR, 1995	71.6	10	7.46E+00
Phenanthrene	mouse	LOAEL/gestation days 7-16 crit. Lifestage/Reproduction, benzo(a)pyrene used as surrogate	Sample et al., 1996	10	10	1.04E+00
Pyrene	mouse	LOAEL/gestation days 7-16 crit. Lifestage/Reproduction, benzo(a)pyrene used as surrogate	Sample et al., 1996	10	10	1.04E+00
bis(2-Ethylhexyl) phthalate	mouse	NOAEL/over 105 days crit. Lifestage/reproduction	Sample et al., 1996	18.3	1	1.91E+01
Pesticides						
4,4'-DDD	mouse	NOAEL/78 weeks, respiratory, female	ATSDR, 2002	142	1	1.48E+02
4,4'-DDE	rat	NOAEL/5 weeks	USEPA, 1999	10	10	1.21E+00
4,4'-DDT	rat	NOAEL/2 yr reproduction, oral	Sample et al., 1996	0.8	1	9.66E-01
Endosulfan I	rat	NOAEL/30 days, reproduction, blood chemistry, endosulfan used as surrogate	Sample et al., 1996	1.5	10	1.81E-01
Endosulfan sulfate	rat	NOAEL/30 days, reproduction, blood chemistry, endosulfan used as surrogate	Sample et al., 1996	1.5	10	1.81E-01
Endrin	mouse	LOAEL/120 d, reproduction	Sample et al., 1996	0.92	10	9.59E-02
Endrin aldehyde	mouse	LOAEL/120 d, reproduction, endrin used as surrogate	Sample et al., 1996	0.92	10	9.59E-02
Endrin ketone	mouse	LOAEL/120 d, reproduction, endrin used as surrogate	Sample et al., 1996	0.92	10	9.59E-02
Heptachlor epoxide	mink	LOAEL/181 d, reproduction, heptachlor used as a surrogate	Sample et al., 1996	1	10	1.29E-01
Methoxychlor	rat	NOAEL/11 month, reproduction	Sample et al., 1996	4	1	4.83E+00
Inorganics						
Aluminum	mouse	LOAEL/mouse over 3 generations, >1 yr/reproduction	Sample et al., 1996	19.3	10	2.01E+00

TABLE J-5
NOAEL SCREENING ECOTOXICITY VALUES - SHORT-TAILED SHREW
SEAD-59 and SEAD-71 Phase II RI Report

COPC	Test Organism	Endpoint / Duration / Effect (survival, growth, reproduction)	Source	Effect Dose (mg/kg/day)	Total CF⁽¹⁾	SEV (mg/kg/day)⁽²⁾
Antimony	mouse	LOAEL/lifetime/lifespan, longevity	Sample et al., 1996	1.25	10	1.30E-01
Arsenic	mouse	LOAEL/3 generations >1 yr/reproduction	Sample et al., 1996	1.26	10	1.31E-01
Barium		The geometric mean of the NOAEL values for reproduction and growth	USEPA, 2005	51.8	1	5.18E+01
Beryllium	rat	NOAEL/lifetime/longevity, weight loss	Sample et al., 1996	0.66	1	7.97E-01
Cadmium	rat	NOAEL/6 wks through mating and gestation/reproduction	Sample et al., 1996	1	1	1.21E+00
Chromium	rat	NOAEL/90 d and 2 yr/reproduction, longevity, Cr(III)	Sample et al., 1996	2737	1	3.31E+03
Chromium, Hexavalent	rat	NOAEL/1 yr/body weight and food consumption	Sample et al., 1996	3.28	1	3.96E+00
Cobalt	rabbit	LOAEL/over 2 wks/cardiac, for cobalt sulfate	RTECS, 2004	140	100	1.95E+00
Copper	mink	NOAEL/357 d/reproduction	Sample et al., 1996	11.7	1	1.51E+01
Iron	Child	Based on the dietary reference intake for a child	Marilyn 2001	0.67	1	1.01E+00
Lead	Rat	Reproductive / 3 generations oral / NOAEL	Sample et al. 1996	8	1	9.66E+00
Magnesium	hamster	lowest published toxic dose/30 weeks/tumorigenic, olfaction, lung	RTECS, 2004	480	10	5.41E+01
Manganese	rat	NOAEL/through gestation for 224 day/reproduction	Sample et al. 1996	88	1	1.06E+02
Mercury	mink	NOAEL/1 yr/reproduction, mercuric sulfide	Sample et al. 1996	1.0	1	1.29E+00
Nickel	Rat	Reproduction / 3 generations diet / NOAEL	Sample et al. 1996	40	1	4.83E+01
Selenium	rat	NOAEL/1yr through 2 generations/reproduction	Sample et al. 1996	0.20	1	2.42E-01
Silver	mouse	LOAEL/125 days/hypoactivity	USEPA, 1999	3.75	10	3.91E-01
Thallium	rat	LOAEL/60 days/testicular function	USEPA, 1999	1.31	10	1.58E-01
Tin	mouse	NOAEL/days 6-15 of gestation/reproduction	Sample et al. 1996	23.4	1	2.44E+01

**TABLE J-5
NOAEL SCREENING ECOTOXICITY VALUES - SHORT-TAILED SHREW
SEAD-59 and SEAD-71 Phase II RI Report**

COPC	Test Organism	Endpoint / Duration / Effect (survival, growth, reproduction)	Source	Effect Dose (mg/kg/day)	Total CF⁽¹⁾	SEV (mg/kg/day)⁽²⁾
Vanadium	rat	LOAEL/60 d prior to gestation, plus through gestation, delivery, and lactation/reproduction	Sample et al. 1996	2.1	10	2.54E-01
Zinc	Rat	Reproduction / day 1-16 of gestation diet / NOAEL	Sample et al. 1996	160	1	1.93E+02

NOAEL = No Observed Adverse Effect Level

COPC = Constituent of Potential Concern

CF = Conversion Factor

SEV = Screening Ecotoxicity Values

(1) For CFs, see Table G-4

(2) SEV = Effective Dose x Scaling Factor / Total CF

Scaling Factors for Toxicity Values:

$$SEV_w = SEV_t * (bw_t / bw_w)^{(1-b)}$$

Where bw is the body weight, and t and w represent the test and wildlife species, respectively, and b is the allometric scaling factor (b=0.94 for mammals, Sample et al., 1999)

From Test Species	To: Short-Tailed Shrew	Weight (kg)
Lab Mouse	1.04	0.03
Rat	1.21	0.35
Mink	1.29	1
Rabbit	1.39	3.8
Child	1.51	15
Hamster	1.13	0.11
	Short-Tailed Shrew	0.015

References:

Agency for Toxic Substances and Disease Registry (ATSDR). On-line resources available at <http://www.atsdr.cdc.gov/toxpro2.html>.

Sample et al., 1996. Toxicological Benchmarks for Wildlife: 1996 Revision.

Sax, N.I. 1984. Dangerous Properties of Industrial Chemicals. 6th Ed.

Marilyn et al., 2001. Dietary Reference Intakes.

USEPA. 1999. Screening Level Ecological Risk Assessment Protocol for Hazardous Waste Combustion Facilities. Peer Review Draft. 1999.

Registry of Toxic Effects of Chemical Substances (RTECS). On-line resources available at <http://www.cdc.gov/niosh/rtecs.html>

Sample, B.E., and C.A. Arenal. 1999. Allometric Models for Inter-species Extrapolation of Wildlife Toxicity Data. Bull Environ Contam Toxicol. 62:653-663.

USEPA. 2005. Ecological Soil Screening Levels for Barium.

**TABLE J-5
NOAEL SCREENING ECOTOXICITY VALUES - RED FOX
SEAD-59 and SEAD-71 Phase II RI Report**

COPC	Test Organism	Endpoint / Duration / Effect (survival, growth, reproduction)	Source	Effect Dose (mg/kg/day)	Total CF⁽¹⁾	SEV (mg/kg/day)⁽²⁾
Semi-Volatile Organic Compounds						
2-Methylnaphthalene	mouse	LOAEL/diet, 81 wks/respiratory, naphthalene used as surrogate	ATSDR, 1995	71.6	10	5.34E+00
Acenaphthene	mouse	LOAEL/gestation days 7-16 crit. Lifestage/Reproduction, benzo(a)pyrene used as surrogate	Sample et al., 1996	10	10	7.46E-01
Acenaphthylene	mouse	LOAEL/gestation days 7-16 crit. Lifestage/Reproduction, benzo(a)pyrene used as surrogate	Sample et al., 1996	10	10	7.46E-01
Anthracene	mouse	LOAEL/gestation days 7-16 crit. Lifestage/Reproduction, benzo(a)pyrene used as surrogate	Sample et al., 1996	10	10	7.46E-01
Benzo(a)anthracene	mouse	LOAEL/gestation days 7-16 crit. Lifestage/Reproduction, benzo(a)pyrene used as surrogate	Sample et al., 1996	10	10	7.46E-01
Benzo(a)pyrene	mouse	LOAEL/gestation days 7-16 crit. Lifestage/Reproduction	Sample et al., 1996	10	10	7.46E-01
Benzo(b)fluoranthene	mouse	LOAEL/gestation days 7-16 crit. Lifestage/Reproduction, benzo(a)pyrene used as surrogate	Sample et al., 1996	10	10	7.46E-01
Benzo(ghi)perylene	mouse	LOAEL/gestation days 7-16 crit. Lifestage/Reproduction, benzo(a)pyrene used as surrogate	Sample et al., 1996	10	10	7.46E-01
Benzo(k)fluoranthene	mouse	LOAEL/gestation days 7-16 crit. Lifestage/Reproduction, benzo(a)pyrene used as surrogate	Sample et al., 1996	10	10	7.46E-01
Carbazole	rat	LD50/oral	Sax, 1984	500	100	4.32E+00
Chrysene	mouse	LOAEL/gestation days 7-16 crit. Lifestage/Reproduction, benzo(a)pyrene used as surrogate	Sample et al., 1996	10	10	7.46E-01
Dibenz(a,h)anthracene	mouse	LOAEL/gestation days 7-16 crit. Lifestage/Reproduction, benzo(a)pyrene used as surrogate	Sample et al., 1996	10	10	7.46E-01
Dibenzofuran	mouse	LOAEL/gestation days 7-16 crit. Lifestage/Reproduction, benzo(a)pyrene used as surrogate	Sample et al., 1996	10	10	7.46E-01
Fluoranthene	mouse	LOAEL/13 wks/hepatic effects	ATSDR, 1995	125	10	9.33E+00

**TABLE J-5
NOAEL SCREENING ECOTOXICITY VALUES - RED FOX
SEAD-59 and SEAD-71 Phase II RI Report**

COPC	Test Organism	Endpoint / Duration / Effect (survival, growth, reproduction)	Source	Effect Dose (mg/kg/day)	Total CF⁽¹⁾	SEV (mg/kg/day)⁽²⁾
Fluorene	mouse	LOAEL/13 wks/hepatic effects	ATSDR, 1995	125	10	9.33E+00
Indeno(1,2,3-cd)pyrene	mouse	LOAEL/gestation days 7-16 crit. Lifestage/Reproduction, benzo(a)pyrene used as surrogate	Sample et al., 1996	10	10	7.46E-01
Naphthalene	mouse	LOAEL/diet, 81 wks/respiratory	ATSDR, 1995	71.6	10	5.34E+00
Phenanthrene	mouse	LOAEL/gestation days 7-16 crit. Lifestage/Reproduction, benzo(a)pyrene used as surrogate	Sample et al., 1996	10	10	7.46E-01
Pyrene	mouse	LOAEL/gestation days 7-16 crit. Lifestage/Reproduction, benzo(a)pyrene used as surrogate	Sample et al., 1996	10	10	7.46E-01
bis(2-Ethylhexyl) phthalate	mouse	NOAEL/over 105 days crit. Lifestage/reproduction	Sample et al., 1996	18.3	1	1.37E+01
Pesticides						
4,4'-DDD	mouse	NOAEL/78 weeks, respiratory, female	ATSDR, 2002	142	1	1.06E+02
4,4'-DDE	rat	NOAEL/5 weeks	USEPA, 1999	10	10	8.65E-01
4,4'-DDT	rat	NOAEL/2 yr reproduction, oral	Sample et al., 1996	0.8	1	6.92E-01
Endosulfan I	rat	NOAEL/30 days, reproduction, blood chemistry, endosulfan used as surrogate	Sample et al., 1996	1.5	10	1.30E-01
Endosulfan sulfate	rat	NOAEL/30 days, reproduction, blood chemistry, endosulfan used as surrogate	Sample et al., 1996	1.5	10	1.30E-01
Endrin	mouse	LOAEL/120 d, reproduction	Sample et al., 1996	0.92	10	6.87E-02
Endrin aldehyde	mouse	LOAEL/120 d, reproduction, endrin used as surrogate	Sample et al., 1996	0.92	10	6.87E-02
Endrin ketone	mouse	LOAEL/120 d, reproduction, endrin used as surrogate	Sample et al., 1996	0.92	10	6.87E-02
Heptachlor epoxide	mink	LOAEL/181 d, reproduction, heptachlor used as a surrogate	Sample et al., 1996	1	10	9.21E-02
Methoxychlor	rat	NOAEL/11 month, reproduction	Sample et al., 1996	4	1	3.46E+00
Inorganics						
Aluminum	mouse	LOAEL/mouse over 3 generations, >1 yr/reproduction	Sample et al., 1996	19.3	10	1.44E+00
Antimony	mouse	LOAEL/lifetime/lifespan, longevity	Sample et al., 1996	1.25	10	9.33E-02

**TABLE J-5
NOAEL SCREENING ECOTOXICITY VALUES - RED FOX
SEAD-59 and SEAD-71 Phase II RI Report**

COPC	Test Organism	Endpoint / Duration / Effect (survival, growth, reproduction)	Source	Effect Dose (mg/kg/day)	Total CF⁽¹⁾	SEV (mg/kg/day)⁽²⁾
Arsenic	mouse	LOAEL/3 generations >1 yr/reproduction	Sample et al., 1996	1.26	10	9.40E-02
Barium		The geometric mean of the NOAEL values for reproduction and growth	USEPA, 2003	51.8	1	5.18E+01
Beryllium	rat	NOAEL/lifetime/longevity, weight loss	Sample et al., 1996	0.66	1	5.71E-01
Cadmium	rat	NOAEL/6 wks through mating and gestation/reproduction	Sample et al., 1996	1	1	8.65E-01
Chromium	rat	NOAEL/90 d and 2 yr/reproduction, longevity, Cr(III)	Sample et al., 1996	2737	1	2.37E+03
Chromium, Hexavalent	rat	NOAEL/1 yr/body weight and food consumption	Sample et al., 1996	3.28	1	2.84E+00
Cobalt	rabbit	LOAEL/over 2 wks/cardiac, for cobalt sulfate	RTECS, 2004	140	100	1.40E+00
Copper	mink	NOAEL/357 d/reproduction	Sample et al., 1996	11.7	1	1.08E+01
Iron	Child	Based on the dietary reference intake for a child	Marilyn 2001	0.67	1	7.26E-01
Lead	Rat	Reproductive / 3 generations oral / NOAEL	Sample et al. 1996	8	1	6.92E+00
Magnesium	hamster	lowest published toxic dose/30 weeks/tumorigenic, olfaction, lung	RTECS, 2004	480	10	3.87E+01
Manganese	rat	NOAEL/through gestation for 224 day/reproduction	Sample et al. 1996	88	1	7.61E+01
Mercury	mink	NOAEL/1 yr/reproduction, mercuric sulfide	Sample et al. 1996	1.0	1	9.21E-01
Nickel	Rat	Reproduction / 3 generations diet / NOAEL	Sample et al. 1996	40	1	3.46E+01
Selenium	rat	NOAEL/1yr through 2 generations/reproduction	Sample et al. 1996	0.20	1	1.73E-01
Silver	mouse	LOAEL/125 days/hypoactivity	USEPA, 1999	3.75	10	2.80E-01
Thallium	rat	LOAEL/60 days/testicular function	USEPA, 1999	1.31	10	1.13E-01
Tin	mouse	NOAEL/days 6-15 of gestation/reproduction	Sample et al. 1996	23.4	1	1.75E+01
Vanadium	rat	LOAEL/60 d prior to gestation, plus through gestation, delivery, and lactation/reproduction	Sample et al. 1996	2.1	10	1.82E-01
Zinc	Rat	Reproduction / day 1-16 of gestation diet / NOAEL	Sample et al. 1996	160	1	1.38E+02

NOAEL = No Observed Adverse Effect Level

**TABLE J-5
NOAEL SCREENING ECOTOXICITY VALUES - RED FOX
SEAD-59 and SEAD-71 Phase II RI Report**

COPC	Test Organism	Endpoint / Duration / Effect (survival, growth, reproduction)	Source	Effect Dose (mg/kg/day)	Total CF⁽¹⁾	SEV (mg/kg/day)⁽²⁾
-------------	----------------------	--	---------------	--------------------------------	-------------------------------	--------------------------------------

COPC = Constituent of Potential Concern

CF = Conversion Factor

SEV = Screening Ecotoxicity Values

(1) For CFs, see Table G-4

(2) SEV = Effective Dose x Scaling Factor / Total CF

Scaling Factors for Toxicity Values:

$$SEV_w = SEV_t * (bw_t / bw_w)^{(1-b)}$$

Where bw is the body weight, and t and w represent the test and wildlife species, respectively, and b is the allometric scaling factor (b=0.94 for mammals, Sample et al., 1999)

From Test Species	To: Red Fox	Weight (kg)
Lab Mouse	0.75	0.03
Rat	0.86	0.35
Mink	0.92	1
Rabbit	1.00	3.8
Child	1.08	15
Hamster	0.81	0.11
	Red Fox weight	3.94

References:

Agency for Toxic Substances and Disease Registry (ATSDR). On-line resources available at <http://www.atsdr.cdc.gov/toxpro2.html>.

Sample et al., 1996. Toxicological Benchmarks for Wildlife: 1996 Revision.

Sax, N.I. 1984. Dangerous Properties of Industrial Chemicals. 6th Ed.

Marilyn et al., 2001. Dietary Reference Intakes.

USEPA. 1999. Screening Level Ecological Risk Assessment Protocol for Hazardous Waste Combustion Facilities. Peer Review Draft. 1999.

Registry of Toxic Effects of Chemical Substances (RTECS). On-line resources available at <http://www.cdc.gov/niosh/rtecs.html>

Sample, B.E., and C.A. Arenal. 1999. Allometric Models for Inter-species Extrapolation of Wildlife Toxicity Data. Bull Environ Contam Toxicol. 62:653-663.

TABLE J-6
LOAEL SCREENING ECOTOXICITY VALUES - DEER MOUSE
SEAD-59 and SEAD-71 Phase II RI Report

COPC	Test Organism	Endpoint / Duration / Effect (survival, growth, reproduction)	Source	Effect Dose (mg/kg/day)	Total CF⁽¹⁾	SEV (mg/kg/day)⁽²⁾
Semi-Volatile Organic Compounds						
Phenanthrene	mouse	LOAEL/gestation days 7-16 crit. Lifestage/Reproduction, benzo(a)pyrene used as surrogate	Sample et al., 1996	10	1	1.04E+01
Pyrene	mouse	LOAEL/gestation days 7-16 crit. Lifestage/Reproduction, benzo(a)pyrene used as surrogate	Sample et al., 1996	10	1	1.04E+01
Pesticides						
4,4'-DDE	rat	NOAEL/5 weeks	USEPA, 1999	10	1	1.21E+01
4,4'-DDT	rat	LOAEL/2 yr reproduction, oral	Sample et al., 1996	4	1	4.84E+00
Inorganics						
Antimony	mouse	LOAEL/lifetime/lifespan, longevity	Sample et al., 1996	1.25	1	1.30E+00
Arsenic	mouse	LOAEL/3 generations >1 yr/reproduction	Sample et al., 1996	1.26	1	1.31E+00
Cadmium	rat	LOAEL/6 weeks critical lifestage	Sample et al., 1996	10	1	1.21E+01
Cobalt	rabbit	LOAEL/over 2 wks/cardiac, for cobalt sulfate	RTECS, 2004	140	10	1.95E+01
Lead	rat	Reproductive / 3 generations oral / NOAEL	Sample et al. 1996	80	1	9.67E+01
Manganese	rat	LOAEL/through gestation for 224 day/reproduction	Sample et al. 1996	284	1	3.43E+02
Silver	mouse	LOAEL/125 days/hypoactivity	USEPA, 1999	3.75	1	3.91E+00
Thallium	rat	LOAEL/60 days/testicular function	USEPA, 1999	1.31	1	1.58E+00
Vanadium	rat	LOAEL/60 d prior to gestation, plus through gestation, delivery, and lactation/reproduction	Sample et al. 1996	2.1	1	2.54E+00
Zinc	rat	Reproduction / day 1-16 of gestation diet / LOAEL	Sample et al. 1996	320	1	3.87E+02

NOAEL = No Observed Adverse Effect Level

COPC = Constituent of Potential Concern

CF = Conversion Factor

SEV = Screening Ecotoxicity Values

**TABLE J-6
LOAEL SCREENING ECOTOXICITY VALUES - DEER MOUSE
SEAD-59 and SEAD-71 Phase II RI Report**

COPC	Test Organism	Endpoint / Duration / Effect (survival, growth, reproduction)	Source	Effect Dose (mg/kg/day)	Total CF ⁽¹⁾	SEV (mg/kg/day) ⁽²⁾
------	---------------	---	--------	-------------------------	-------------------------	--------------------------------

(1) For CFs, see Table G-4

(2) SEV = Effective Dose x Scaling Factor / Total CF

Scaling Factors for Toxicity Values:

$$SEV_w = SEV_t * (bw_t / bw_w)^{(1-b)}$$

Where bw is the body weight, and t and w represent the test and wildlife species, respectively, and b is the allometric scaling factor (b=0.94 for mammals, Sample et al., 1999)

<u>From Test Species</u>	<u>To: Deer Mouse</u>	<u>Weight (kg)</u>
Lab Mouse	1.04	0.03
Rat	1.21	0.35
Rabbit	1.39	3.8
	Deer Mouse	0.0148

References:

Agency for Toxic Substances and Disease Registry (ATSDR). On-line resources available at <http://www.atsdr.cdc.gov/toxpro2.html>.

Sample et al., 1996. Toxicological Benchmarks for Wildlife: 1996 Revision.

USEPA. 1999. Screening Level Ecological Risk Assessment Protocol for Hazardous Waste Combustion Facilities. Peer Review Draft. 1999.

Registry of Toxic Effects of Chemical Substances (RTECS). On-line resources available at <http://www.cdc.gov/niosh/rtecs.html>

Sample, B.E., and C.A. Arenal. 1999. Allometric Models for Inter-species Extrapolation of Wildlife Toxicity Data. Bull Environ Contam Toxicol. 62:653-663.

TABLE J-6
LOAEL SCREENING ECOTOXICITY VALUES - American Robin
SEAD-59 and SEAD-71 Phase II RI Report

COPC	Test Organism	Endpoint / Duration / Effect (survival, growth, reproduction)	Source	Effect Dose (mg/kg/day)	Total CF⁽¹⁾	SEV (mg/kg/day)⁽²⁾
Semi-Volatile Organic Compounds						
2-Methylnaphthalene	mallard	LOAEL/diet 7 months/physiological for mixed PAHs	Eisler, 1987	285	10	2.85E+01
Pesticides						
4,4'-DDE	Coturnix quail	Acute (5 days) LOAEL (mortality)	USEPA, 1999	84.5	10	8.45E+00
4,4'-DDT	brown pelican	LOAEL/diet, 5 yr, reproduction	Sample et al., 1996	0.028	1	2.80E-02
Inorganics						
Lead	American Kestrels	NOAEL/7 months/reproduction	Sample et al. 1996	3.85	0.1	3.85E+01
Manganese	Japanese quail	NOAEL/75 d/growth, aggressive behavior	Sample et al. 1996	977	1	9.77E+02
Zinc	white Leghorn hen	LOAEL/44 wks, reproduction	Sample et al. 1996	130.9	1	1.31E+02

NOAEL = No Observed Adverse Effect Level

COPC = Constituent of Potential Concern

CF = Conversion Factor

SEV = Screening Ecotoxicity Values

(1) For CFs, see Table G-4

(2) SEV = Effective Dose x Scaling Factor / Total CF

References:

Eisler, R. 1985-1995. Contaminant Hazards Review Series, Biological Report Series, US Fish and Wildlife Service, Patuxent Wildlife Research Center, Laurel, MD.

Sample et al., 1996. Toxicological Benchmarks for Wildlife: 1996 Revision.

USEPA. 1999. Screening Level Ecological Risk Assessment Protocol for Hazardous Waste Combustion Facilities. Peer Review Draft. 1999.

TABLE J-6
LOAEL SCREENING ECOTOXICITY VALUES - SHORT-TAILED SHREW
SEAD-59 and SEAD-71 Phase II RI Report

COPC	Test Organism	Endpoint / Duration / Effect (survival, growth, reproduction)	Source	Effect Dose (mg/kg/day)	Total CF⁽¹⁾	SEV (mg/kg/day)⁽²⁾
Semi-Volatile Organic Compounds						
Benzo(a)anthracene	mouse	LOAEL/gestation days 7-16 crit. Lifestage/Reproduction, benzo(a)pyrene used as surrogate	Sample et al., 1996	10	1	1.04E+01
Benzo(a)pyrene	mouse	LOAEL/gestation days 7-16 crit. Lifestage/Reproduction	Sample et al., 1996	10	1	1.04E+01
Benzo(b)fluoranthene	mouse	LOAEL/gestation days 7-16 crit. Lifestage/Reproduction, benzo(a)pyrene used as surrogate	Sample et al., 1996	10	1	1.04E+01
Chrysene	mouse	LOAEL/gestation days 7-16 crit. Lifestage/Reproduction, benzo(a)pyrene used as surrogate	Sample et al., 1996	10	1	1.04E+01
Phenanthrene	mouse	LOAEL/gestation days 7-16 crit. Lifestage/Reproduction, benzo(a)pyrene used as surrogate	Sample et al., 1996	10	1	1.04E+01
Pyrene	mouse	LOAEL/gestation days 7-16 crit. Lifestage/Reproduction, benzo(a)pyrene used as surrogate	Sample et al., 1996	10	1	1.04E+01
Pesticides						
4,4'-DDE	rat	NOAEL/5 weeks	USEPA, 1999	10	1	1.21E+01
4,4'-DDT	rat	LOAEL/2 yr reproduction, oral	Sample et al., 1996	4	1	4.83E+00
Inorganics						
Antimony	mouse	LOAEL/lifetime/lifespan, longevity	Sample et al., 1996	1.25	1	1.30E+00
Arsenic	mouse	LOAEL/3 generations >1 yr/reproduction	Sample et al., 1996	1.26	1	1.31E+00
Cadmium	rat	LOAEL/6 weeks critical lifestage	Sample et al., 1996	10	1	1.21E+01
Cobalt	rabbit	LOAEL/over 2 wks/cardiac, for cobalt sulfate	RTECS, 2004	140	10	1.95E+01
Lead	rat	Reproductive / 3 generations oral / LOAEL	Sample et al. 1996	80	1	9.66E+01
Manganese	rat	LOAEL/through gestation for 224 day/reproduction	Sample et al. 1996	284	1	3.43E+02

TABLE J-6
LOAEL SCREENING ECOTOXICITY VALUES - SHORT-TAILED SHREW
SEAD-59 and SEAD-71 Phase II RI Report

COPC	Test Organism	Endpoint / Duration / Effect (survival, growth, reproduction)	Source	Effect Dose (mg/kg/day)	Total CF⁽¹⁾	SEV (mg/kg/day)⁽²⁾
Silver	mouse	LOAEL/125 days/hypoactivity	USEPA, 1999	3.75	1	3.91E+00
Thallium	rat	LOAEL/60 days/testicular function	USEPA, 1999	1.31	1	1.58E+00
Vanadium	rat	LOAEL/60 d prior to gestation, plus through gestation, delivery, and lactation/reproduction	Sample et al. 1996	2.1	1	2.54E+00
Zinc	rat	Reproduction / day 1-16 of gestation diet / LOAEL	Sample et al. 1996	320	1	3.87E+02

NOAEL = No Observed Adverse Effect Level

COPC = Constituent of Potential Concern

CF = Conversion Factor

SEV = Screening Ecotoxicity Values

(1) For CFs, see Table G-4

(2) SEV = Effective Dose x Scaling Factor / Total CF

Scaling Factors for Toxicity Values:

$$SEV_w = SEV_t * (bw_t / bw_w)^{(1-b)}$$

Where bw is the body weight, and t and w represent the test and wildlife species, respectively, and b is the allometric scaling factor (b=0.94 for mammals, Sample et al., 1999)

From Test Species	To: Short-Tailed Shrew	Weight (kg)
Lab Mouse	1.04	0.03
Rat	1.21	0.35
Rabbit	1.39	3.8
	Short-Tailed Shrew	0.015

References:

Sample et al., 1996. Toxicological Benchmarks for Wildlife: 1996 Revision.

USEPA. 1999. Screening Level Ecological Risk Assessment Protocol for Hazardous Waste Combustion Facilities. Peer Review Draft. 1999.

Registry of Toxic Effects of Chemical Substances (RTECS). On-line resources available at <http://www.cdc.gov/niosh/rtecs.html>

Sample, B.E., and C.A. Arenal. 1999. Allometric Models for Inter-species Extrapolation of Wildlife Toxicity Data. Bull Environ Contam Toxicol. 62:653-663.

**TABLE J-6
LOAEL SCREENING ECOTOXICITY VALUES - RED FOX
SEAD-59 and SEAD-71 Phase II RI Report**

COPC	Test Organism	Endpoint / Duration / Effect (survival, growth, reproduction)	Source	Effect Dose (mg/kg/day)	Total CF ⁽¹⁾	SEV (mg/kg/day) ⁽²⁾
Inorganics						
Antimony	mouse	LOAEL/lifetime/lifespan, longevity	Sample et al., 1996	1.25	1	9.33E-01

NOAEL = No Observed Adverse Effect Level

COPC = Constituent of Potential Concern

CF = Conversion Factor

SEV = Screening Ecotoxicity Values

(1) For CFs, see Table G-4

(2) SEV = Effective Dose x Scaling Factor / Total CF

Scaling Factors for Toxicity Values:

$$SEV_w = SEV_t * (bw_t / bw_w)^{(1-b)}$$

Where bw is the body weight, and t and w represent the test and wildlife species, respectively, and b is the allometric scaling factor (b=0.94 for mammals, Sample et al., 1999)

From Test Species	To: Red Fox	Weight (kg)
Lab Mouse	0.75	0.03
	Red Fox weight	3.94

References:

Agency for Toxic Substances and Disease Registry (ATSDR). On-line resources available at <http://www.atsdr.cdc.gov/toxpro2.html>.

Sample et al., 1996. Toxicological Benchmarks for Wildlife: 1996 Revision.

Sample, B.E., and C.A. Arenal. 1999. Allometric Models for Inter-species Extrapolation of Wildlife Toxicity Data. Bull Environ Contam Toxicol. 62:653-663.

**Table J-7
Receptor Intake Rates and Dietary Fractions
SEAD-59 and SEAD-71 Phase II RI Report**

Receptor	Foraging Range (acres)	Feeding Rate⁽¹⁾ (kg wet/day)	Plant Diet Fraction	Invertebrate Diet Fraction	Small Animal Diet Fraction	Soil Ingestion Rate (kg DW/day)	Water Intake (L/day)	Body Weight (kg)	Source
Deer Mouse (a)	1.50E-01	8.87E-03	3.72E-01	6.08E-01	0.00E+00	2.13E-05	2.23E-03	1.48E-02	USEPA,1999; USEPA, 1993
American Robin (b)	2.72E-01	3.55E-02	7.00E-02	9.30E-01	0.00E+00	1.14E-03	1.10E-02	8.00E-02	USEPA,1999; USEPA, 1993
Short-tailed Shrew (c)	7.41E-02	9.30E-03	5.40E-02	8.65E-01	8.10E-02	2.04E-04	2.27E-03	1.50E-02	USEPA,1999; USEPA, 1993
Red Fox (d)	2.37E+02	6.62E-01	1.70E-01	4.00E-02	7.90E-01	5.95E-03	3.40E-01	3.94E+00	USEPA,1999; USEPA, 1993

Notes:

(1) Feeding rate based on Nagy (1999) and USEPA 1993.

(a) Deer mouse body weight, Food IR, water IR, and soil IR from EPA, 1999. Others from USEPA, 1993. Foraging range based on average of adult M/F in Virginia.

Dietary fractions based on summer months in Virginia.

(b) For purposes of this assessment, the American robin dietary composition was assumed to be insectivorous. Body weight, Food IR, water IR, and soil IR from EPA, 1999. Others from USEPA, 1993
Feeding rate was based on spring diet for birds of eastern U.S. Foraging range is larger than its territory, which is the range given above.

(c) Short-tailed shrew body weight, Food IR, water IR, and soil IR from EPA, 1999. Others from USEPA, 1993. Foraging range based on the lower range of New York/old field location.

Dietary fractions based on summer months in Virginia.

(d) Red Fox body weight, Food IR, water IR, and soil IR from EPA, 1999. Others from USEPA, 1993.

Foraging range based on adult female all year (mean). Dietary fractions based on average for the year.

Sources:

1. USEPA. 1999. Screening Level Ecological Risk Assessment Protocol for Hazardous Waste Combustion Facilities. Peer Review Draft. November.

2. USEPA. 1993. Wildlife Exposure Factors Handbook.

3. Nagy. 1999. Energetics of Free-ranging Mammals, Reptiles, and Birds. Ann. Rev. Nutr. 19: 247-277.

TABLE J-8
CHEMICAL-SPECIFIC UPTAKE FACTORS
SEAD-59 and SEAD-71 Phase II RI Report

COPC	Soil-To-Soil Invertebrate¹ (mg COPC/kg wet tissue)/(mg COPC/kg dry soil)	Small Mammal BAF² (mg COPC/kg wet tissue)/(mg COPC/kg dry soil)	Soil-To-Plant³ (mg COPC/kg dry tissue)/(mg COPC/kg dry soil)
Semi-Volatile Organic Compounds			
2-Methylnaphthalene	0.07	4.61E-04	0.163
Acenaphthene	0.07	4.61E-04	0.21
Acenaphthylene	0.07	4.61E-04	0.17
Anthracene	0.07	4.61E-04	0.104
Benzo(a)anthracene	0.03	1.46E-04	0.0202
Benzo(a)pyrene	0.07	4.61E-04	0.011
Benzo(b)fluoranthene	0.07	5.46E-04	0.0101
Benzo(ghi)perylene	0.07	4.61E-04	0.0057
Benzo(k)fluoranthene	0.08	5.43E-04	0.0101
Carbazole	1	6.29E-01	0.27
Chrysene	0.04	1.88E-04	0.0187
Dibenz(a,h)anthracene	0.07	1.21E-03	0.0064
Dibenzofuran	1	5.50E-01	0.151
Fluoranthene	0.07	4.61E-04	0.0372
Fluorene	0.07	4.61E-04	0.149
Indeno(1,2,3-cd)pyrene	0.08	2.82E-03	0.0039
Naphthalene	0.07	4.61E-04	0.42
Phenanthrene	0.07	4.61E-04	0.102
Pyrene	0.07	4.61E-04	0.0443
bis(2-Ethylhexyl) phthalate	1309	5.50E-05	0.038
PCBs			
Aroclor-1260	1.13	1.21E-04	0.01
Pesticides			
4,4'-DDD	1.26	6.18E-04	0.00937
4,4'-DDE	1.26	6.18E-04	0.00937
4,4'-DDT	1.26	6.18E-04	0.00937
Endosulfan I	0.3	5.54E-01	0.165
Endosulfan sulfate	0.3	6.42E-01	0.30
Endrin	0.18	4.02E-01	0.046
Endrin aldehyde	0.18	4.39E-01	0.065
Endrin ketone	0.18	4.02E-01	0.046
Heptachlor epoxide	0.13	3.55E-05	0.029
Methoxychlor	31	3.99E-01	0.045
Inorganics			
Aluminum	0.22	1.50E-03	0.004
Antimony	0.22	1.00E-03	0.2
Arsenic	0.11	2.00E-03	0.036
Barium	0.091	1.50E-04	0.15
Beryllium	0.045	1.00E-03	0.01
Cadmium	0.96	5.50E-04	0.364
Chromium	0.01	5.50E-03	0.0075
Chromium, Hexavalent	0.01	5.50E-03	0.0075
Cobalt	0.122	2.00E-02	0.081
Copper	0.04	1.00E-02	0.4
Iron	0.22	2.00E-02	0.004
Lead	0.03	3.00E-04	0.045
Magnesium	0.22	5.00E-03	1

TABLE J-8
CHEMICAL-SPECIFIC UPTAKE FACTORS
SEAD-59 and SEAD-71 Phase II RI Report

COPC	Soil-To-Soil Invertebrate ¹ (mg COPC/kg wet tissue)/(mg COPC/kg dry soil)	Small Mammal BAF ² (mg COPC/kg wet tissue)/(mg COPC/kg dry soil)	Soil-To-Plant ³ (mg COPC/kg dry tissue)/(mg COPC/kg dry soil)
Manganese	0.054	4.00E-04	0.25
Mercury	0.04	2.50E-01	0.0375
Nickel	0.02	6.00E-03	0.032
Selenium	0.22	1.50E-02	0.016
Silver	0.22	3.00E-03	0.4
Thallium	0.22	4.00E-02	0.004
Tin	0.22	8.00E-02	0.03
Vanadium	0.22	2.50E-03	0.0055
Zinc	0.56	1.00E-01	1.2E-12

COPC = Constituent of Potential Concern

BAF = Bioaccumulation factor

SP = Soil-to-plant uptake factor

1. Values from USEPA. 1999. *Screening Level Ecological Risk Assessment Protocol for Hazardous Waste Combustion Facilities*. Peer Review Draft. 1999.

The value for Benzo(a)pyrene was used for PAHs with no bioaccumulation values in the EPA document.

The value for 4,4'-DDE was used for 4,4'-DDT and 4,4'-DDD.

The value for total chromium was used for chromium and chromium (VI).

Default value of 1 was used for carbazole and dibenzofuran.

The value for mercuric chloride was used for mercury

For metals without EPA recommended values, the median value from USEPA (2003) Table 8 (Attachment 4-1) or the arithmetic mean of the recommended values for the available metals was used.

For SVOCs not listed in the USEPA (1999) report, the values were calculated using the equation presented in the USEPA (2003), attachment 4-1. Kow from USEPA (1999) Soil Screening Guidance or HSDB.

Value for endosulfan I was from Menzie et al., 1992.

Values for endrin, endrin ketone, heptachlor, and heptachlor epoxide were from USEPA (1994).

2. Values for inorganics were from Baes, et al., 1984. *A Review and Analysis of Parameters for Assessing Transport of Environmentally Released Radionuclides through Agriculture*.

Values for organics were from USEPA (1999) Table D-3. The highest value for terrestrial mammals was used.

BCF for Aroclor 1254 was used for Aroclor 1260. BCF for 4,4'-DDE was used for 4,4'-DDD and 4,4'-DDT.

BCF for heptachlor was used for heptachlor epoxide.

Values for organics were based on equation provided in USEPA (2003), attachment 4-1. $\lg BAF = 0.338 - 0.145 \lg Kow$.

LogKow from Groundwater Chemicals Desk Reference, 1989, HSDB, or USEPA (1999).

LogKow for carbazole and bis(2-ethylhexyl)phthalate were from Risk Assessment Information System (RAIS). On-line resources available at http://risk.lsd.ornl.gov/cgi-bin/tox/TOX_select?select=nrad

3. Values from USEPA. 1999. *Screening Level Ecological Risk Assessment Protocol for Hazardous Waste Combustion Facilities*. Peer Review Draft. 1999.

For PAHs and pesticides, the values were calculated based on the model presented in Travers et al., 1988: $\log BCF = 1.588 - 0.578 \log Kow$, Kow is from USEPA (1999) or HSDB.

The value for 4,4'-DDE was used for 4,4'-DDT and 4,4'-DDD.

The value for Aroclor 1254 was used for Aroclor 1260.

The value for total chromium was used for chromium and chromium (VI).

Values for cobalt, iron, manganese, and tin were from NRC. 1992. US Nuclear Regulatory Commission. *Residual Radioactive Contamination from Decommissioning: Technical Basis for Translating Contamination Levels to Annual Total Effective Dose Equivalent*.

The value for mercuric chloride was used for mercury

A default value of 1 was used for magnesium.

Values for manganese and vanadium were from Baes, et al., 1984. *A Review and Analysis of Parameters for Assessing Transport of Environmentally Released Radionuclides through Agriculture*.

Table J-9A
Exposure Point Concentration for SEAD-59 Soil
SEAD-59 and SEAD-71 Phase II RI Report

COPC	Maximum Detected Concentration	
	Surface Soil 0-2 ft bgs. (mg/kg)	Surface Soil & Subsurface Soil 0-4 ft bgs. (mg/kg)
Semi-Volatile Organic Compounds		
2-Methylnaphthalene		10
Acenaphthene	2.68	2.68
Acenaphthylene	1.7	1.7
Anthracene	4.395	4.395
Benzo(a)anthracene	8.9	8.9
Benzo(a)pyrene	8.05	8.05
Benzo(b)fluoranthene	6.8	6.8
Benzo(ghi)perylene	5.2	5.2
Benzo(k)fluoranthene	7.35	7.35
Carbazole	0.755	0.755
Chrysene	8.9	8.9
Dibenz(a,h)anthracene	1.665	1.665
Dibenzofuran	1.875	1.875
Fluoranthene	23.5	23.5
Fluorene	2.64	3
Indeno(1,2,3-cd)pyrene	4.95	4.95
Naphthalene	1.325	1.325
Phenanthrene	21.3	21.3
Pyrene	19.2	19.2
Pesticides		
4,4'-DDD	0.74	0.74
4,4'-DDE	2.6	2.6
4,4'-DDT	3.7	3.7
Inorganics		
Antimony	424	424
Arsenic	32.2	32.2
Cadmium	3.2	3.2
Chromium	39.3	39.3
Cobalt	47.8	47.8
Copper	305	305
Lead	164	164
Manganese	1290	1290
Mercury	0.95	0.95
Nickel	88.3	88.3
Selenium	1.5	1.5
Silver	2.9	2.9
Thallium	1.8	1.8
Vanadium	28.5	28.5
Zinc	341	341

COPC = Constituent of Potential Concern

Table J-9B
Exposure Point Concentration for SEAD-59 Stockpile Soil
SEAD-59 AND SEAD-71 PHASE II RI

COPC	Maximum Detected Concentration
	SEAD-59 Stockpile Soil (mg/kg)
Semi-Volatile Organic Compounds	
Acenaphthylene	3.5
Anthracene	6.6
Benzo(a)anthracene	14
Benzo(a)pyrene	16
Benzo(b)fluoranthene	11
Benzo(ghi)perylene	8
Benzo(k)fluoranthene	13
Carbazole	1.1
Chrysene	13
Dibenz(a,h)anthracene	2.9
Dibenzofuran	1.3
Fluoranthene	29
Fluorene	3.1
Indeno(1,2,3-cd)pyrene	8
Naphthalene	1.2
Phenanthrene	17
Pyrene	22
Pesticides	
4,4'-DDD	0.45
4,4'-DDE	0.23
4,4'-DDT	0.52
Inorganics	
Antimony	43.9
Arsenic	7.3
Cadmium	1.2
Chromium	35
Cobalt	13.9
Copper	51.8
Lead	1440
Manganese	1220
Mercury	0.52
Nickel	56.6
Selenium	0.72
Silver	4.7
Vanadium	35.4
Zinc	185

COPC = Constituent of Potential Concern

Table J-9C
Exposure Point Concentration for SEAD-71 Soil
SEAD-59 and SEAD-71 Phase II RI Report

COPC	Maximum Detected Concentration	
	Surface Soil 0-2 ft bgs. (mg/kg)	Surface Soil & Subsurface Soil 0-4 ft bgs. (mg/kg)
Semi-Volatile Organic Compounds		
2-Methylnaphthalene	19	19
Acenaphthene	42	42
Acenaphthylene	1.8	1.8
Anthracene	100	100
Benzo(a)anthracene	150	150
Benzo(a)pyrene	120	120
Benzo(b)fluoranthene	88	88
Benzo(ghi)perylene	62	62
Benzo(k)fluoranthene	130	130
Carbazole	77	77
Chrysene	150	150
Dibenz(a,h)anthracene	25	25
Dibenzofuran	38	38
Fluoranthene	440	440
Fluorene	62	62
Indeno(1,2,3-cd)pyrene	65	65
Naphthalene	46	46
Phenanthrene	290	290
Pyrene	280	280
Pesticides		
4,4'-DDD	0.24	0.24
4,4'-DDE	0.81	0.81
4,4'-DDT	1.3	1.3
Endosulfan I	0.2	
Endosulfan sulfate	0.11	0.11
Endrin	0.12	0.12
Endrin aldehyde	0.12	0.12
Endrin ketone	0.18	0.18
Heptachlor epoxide	0.18	0.18
Methoxychlor	0.52	0.52
Inorganics		
Antimony	19.3	19.3
Arsenic	14.6	14.6
Cadmium	12.1	12.1
Chromium	60.3	60.3
Cobalt	14.6	14.6
Copper	134	134
Lead	3470	3470
Manganese	1330	1330
Mercury	2.7	2.7
Nickel	110	110
Selenium	1.8	1.8
Silver	2.2	2.2
Thallium	2.3	2.3
Vanadium	29.2	29.2
Zinc	3660	3660

COPC = Constituent of Potential Concern

Table J-9D
Exposure Point Concentration for SEAD-71 Soil (Fenced Area Excluded)
SEAD-59 and SEAD-71 Phase II RI Report

COPC	Maximum Detected Concentration	
	Surface Soil	Surface Soil & Subsurface Soil
	0-2 ft bgs. (mg/kg)	0-4 ft bgs. (mg/kg)
Semi-Volatile Organic Compounds		
2-Methylnaphthalene	0.77	0.77
Acenaphthene	5.8	5.8
Acenaphthylene	1.8	1.8
Anthracene	11	11
Benzo(a)anthracene	37	37
Benzo(a)pyrene	22	22
Benzo(b)fluoranthene	26	26
Benzo(ghi)perylene	10	10
Benzo(k)fluoranthene	15	15
Carbazole	9.5	9.5
Chrysene	36	36
Dibenz(a,h)anthracene	9.8	9.8
Dibenzofuran	1.4	1.4
Fluoranthene	88	88
Fluorene	2.8	2.8
Indeno(1,2,3-cd)pyrene	12	12
Naphthalene	1.1	1.1
Phenanthrene	66	66
Pyrene	63	63
Pesticides		
4,4'-DDD	0.017	0.017
4,4'-DDE	0.19	0.19
4,4'-DDT	0.12	0.12
Endosulfan I	0.2	0.2
Endosulfan sulfate	0.0046	0.0046
Endrin	0.029	0.029
Endrin aldehyde	0.0091	0.0091
Endrin ketone	0.017	0.017
Heptachlor epoxide	0.0064	0.0064
Methoxychlor	0.062	0.062
Inorganics		
Antimony	11.5	11.5
Arsenic	14.6	14.6
Cadmium	0.71	0.71
Chromium	37.1	37.1
Cobalt	13.9	13.9
Copper	102	102
Lead	1010	1010
Manganese	1330	1330
Mercury	1	1
Nickel	110	110
Selenium	1.8	1.8
Silver	1.8	1.8
Thallium	2.3	2.3
Vanadium	24	24
Zinc	1740	1740

COPC = Constituent of Potential Concern

TABLE J-10A
DEER MOUSE (Peromyscus maniculatus) EXPOSURE - SEAD-59
SEAD-59 and SEAD-71 Phase II RI Report

COPC	Surface Soil (0-2 ft bgs) EPC (mg/kg)	Total Soil (0-4 ft bgs) EPC (mg/kg)	SP (mg COPC/kg dry tissue)/(mg COPC/kg dry soil)	Terrestrial Invertebrate BAF (mg COPC/kg wet tissue)/(mg COPC/kg dry soil)	Deer Mouse Surface Soil Exposure (mg/kg/day)	Deer Mouse Total Soil Exposure (mg/kg/day)
Semi-Volatile Organic Compounds						
2-Methylnaphthalene		10	1.63E-01	7.00E-02	0.00E+00	3.42E-01
Acenaphthene	2.68	2.68	2.10E-01	7.00E-02	9.72E-02	9.72E-02
Acenaphthylene	1.7	1.7	1.72E-01	7.00E-02	5.88E-02	5.88E-02
Anthracene	4.395	4.395	1.04E-01	7.00E-02	1.39E-01	1.39E-01
Benzo(a)anthracene	8.9	8.9	2.02E-02	3.00E-02	1.18E-01	1.18E-01
Benzo(a)pyrene	8.05	8.05	1.10E-02	7.00E-02	2.21E-01	2.21E-01
Benzo(b)fluoranthene	6.8	6.8	1.01E-02	7.00E-02	1.86E-01	1.86E-01
Benzo(ghi)perylene	5.2	5.2	5.70E-03	7.00E-02	1.41E-01	1.41E-01
Benzo(k)fluoranthene	7.35	7.35	1.01E-02	8.00E-02	2.28E-01	2.28E-01
Carbazole	0.755	0.755	2.74E-01	1.00E+00	2.85E-01	2.85E-01
Chrysene	8.9	8.9	1.87E-02	4.00E-02	1.50E-01	1.50E-01
Dibenz(a,h)anthracene	1.665	1.665	6.40E-03	7.00E-02	4.53E-02	4.53E-02
Dibenzofuran	1.875	1.875	1.51E-01	1.00E+00	6.98E-01	6.98E-01
Fluoranthene	23.5	23.5	3.72E-02	7.00E-02	6.72E-01	6.72E-01
Fluorene	2.64	3	1.49E-01	7.00E-02	8.86E-02	1.01E-01
Indeno(1,2,3-cd)pyrene	4.95	4.95	3.90E-03	8.00E-02	1.52E-01	1.52E-01
Naphthalene	1.325	1.325	4.20E-01	7.00E-02	6.05E-02	6.05E-02
Phenanthrene	21.3	21.3	1.02E-01	7.00E-02	6.70E-01	6.70E-01
Pyrene	19.2	19.2	4.43E-02	7.00E-02	5.55E-01	5.55E-01
Pesticides						
4,4'-DDD	0.74	0.74	9.37E-03	1.26E+00	3.41E-01	3.41E-01
4,4'-DDE	2.6	2.6	9.37E-03	1.26E+00	1.20E+00	1.20E+00
4,4'-DDT	3.7	3.7	9.37E-03	1.26E+00	1.70E+00	1.70E+00
Metals						
Antimony	424	424	2.00E-01	2.20E-01	3.83E+01	3.83E+01
Arsenic	32.2	32.2	3.60E-02	1.10E-01	1.39E+00	1.39E+00
Cadmium	3.2	3.2	3.64E-01	9.60E-01	1.17E+00	1.17E+00
Chromium	39.3	39.3	7.50E-03	1.00E-02	2.13E-01	2.13E-01
Cobalt	47.8	47.8	8.10E-02	1.22E-01	2.36E+00	2.36E+00
Copper	305	305	4.00E-01	4.00E-02	1.03E+01	1.03E+01
Lead	164	164	4.50E-02	3.00E-02	2.36E+00	2.36E+00
Manganese	1290	1290	2.50E-01	5.40E-02	4.16E+01	4.16E+01
Mercury	0.95	0.95	3.75E-02	4.00E-02	1.68E-02	1.68E-02
Nickel	88.3	88.3	3.20E-02	2.00E-02	8.96E-01	8.96E-01
Selenium	1.5	1.5	1.60E-02	2.20E-01	1.23E-01	1.23E-01
Silver	2.9	2.9	4.00E-01	2.20E-01	2.88E-01	2.88E-01
Thallium	1.8	1.8	4.00E-03	2.20E-01	1.47E-01	1.47E-01
Vanadium	28.5	28.5	5.50E-03	2.20E-01	2.33E+00	2.33E+00
Zinc	341	341	1.20E-12	5.60E-01	7.00E+01	7.00E+01

COPC = Constituent of Potential Concern
EPC = Exposure Point Concentration, the maximum detected concentration
BAF = Bioaccumulation Factor (unitless)
SP = Soil to plant uptake factor (unitless)
(1) Exposure = [(Cs*SP*CF*PDF*FR) + (Cs*IDF*BAF*FR) + (Cs*Is)]*SFF/BW
Cs = EPC in the appropriate soil exposure interval (mg COPC/kg dry soil)
SP = Soil-to-plant uptake factor ((mg COPC/kg dry tissue)/(mg COPC/kg dry soil))
CF = Dry weight to wet weight plant matter conversion factor = 0.2 (unitless)
PDF = Plant dietary fraction (unitless)
FR = Feeding rate (kg/day)
IDF = Invertebrate dietary fraction (unitless)
Is = Soil dietary (kg dry/day)
SFF = Site foraging frequency = 1 (unitless)
BW = Body weight (kg)

TABLE J-10B
DEER MOUSE (*Peromyscus maniculatus*) EXPOSURE - SEAD-59 STOCKPILE SOIL
SEAD-59 AND SEAD-71 PHASE II RI REPORT

COPC	SEAD-59 Stockpile Soil EPC (mg/kg)	SP (mg COPC/kg dry tissue)/(mg COPC/kg dry soil)	Terrestrial Invertebrate BAF (mg COPC/kg wet tissue)/(mg COPC/kg dry soil)	Deer Mouse Stockpile Soil Exposure (mg/kg/day)
Semi-Volatile Organic Compounds				
Acenaphthylene	3.5	1.72E-01	7.00E-02	1.21E-01
Anthracene	6.6	1.04E-01	7.00E-02	2.08E-01
Benzo(a)anthracene	14	2.02E-02	3.00E-02	1.86E-01
Benzo(a)pyrene	16	1.10E-02	7.00E-02	4.39E-01
Benzo(b)fluoranthene	11	1.01E-02	7.00E-02	3.01E-01
Benzo(ghi)perylene	8	5.70E-03	7.00E-02	2.17E-01
Benzo(k)fluoranthene	13	1.01E-02	8.00E-02	4.03E-01
Carbazole	1.1	2.74E-01	1.00E+00	4.15E-01
Chrysene	13	1.87E-02	4.00E-02	2.19E-01
Dibenz(a,h)anthracene	2.9	6.40E-03	7.00E-02	7.89E-02
Dibenzofuran	1.3	1.51E-01	1.00E+00	4.84E-01
Fluoranthene	29	3.72E-02	7.00E-02	8.29E-01
Fluorene	3.1	1.49E-01	7.00E-02	1.04E-01
Indeno(1,2,3-cd)pyrene	8	3.90E-03	8.00E-02	2.46E-01
Naphthalene	1.2	4.20E-01	7.00E-02	5.48E-02
Phenanthrene	17	1.02E-01	7.00E-02	5.35E-01
Pyrene	22	4.43E-02	7.00E-02	6.36E-01
Pesticides				
4,4'-DDD	0.45	9.37E-03	1.26E+00	2.07E-01
4,4'-DDE	0.23	9.37E-03	1.26E+00	1.06E-01
4,4'-DDT	0.52	9.37E-03	1.26E+00	2.39E-01
Inorganics				
Antimony	43.9	2.00E-01	2.20E-01	3.97E+00
Arsenic	7.3	3.60E-02	1.10E-01	3.14E-01
Cadmium	1.2	3.64E-01	9.60E-01	4.40E-01
Chromium	35	7.50E-03	1.00E-02	1.89E-01
Cobalt	13.9	8.10E-02	1.22E-01	6.87E-01
Copper	51.8	4.00E-01	4.00E-02	1.75E+00
Lead	1440	4.50E-02	3.00E-02	2.07E+01
Manganese	1220	2.50E-01	5.40E-02	3.93E+01
Mercury	0.52	3.75E-02	4.00E-02	9.19E-03
Nickel	56.6	3.20E-02	2.00E-02	5.74E-01
Selenium	0.72	1.60E-02	2.20E-01	5.92E-02
Silver	4.7	4.00E-01	2.20E-01	4.67E-01
Vanadium	35.4	5.50E-03	2.20E-01	2.89E+00
Zinc	185	1.20E-12	5.60E-01	3.80E+01

COPC = Constituent of Potential Concern

EPC = Exposure Point Concentration, the maximum detected concentration

BAF = Bioaccumulation Factor (unitless)

SP = Soil to plant uptake factor (unitless)

(1) Exposure = $[(Cs * SP * CF * PDF * FR) + (Cs * IDF * BAF * FR) + (Cs * Is)] * SFF / BW$

Cs = EPC in the appropriate soil exposure interval (mg COPC/kg dry soil)

SP = Soil-to-plant uptake factor ((mg COPC/kg dry tissue)/(mg COPC/kg dry soil))

CF = Dry weight to wet weight plant matter conversion factor = 0.2 (unitless)

PDF = Plant dietary fraction (unitless)

FR = Feeding rate (kg/day)

IDF = Invertebrate dietary fraction (unitless)

Is = Soil dietary (kg dry/day)

SFF = Site foraging frequency = 1 (unitless)

BW = Body weight (kg)

TABLE J-10C
DEER MOUSE (*Peromyscus maniculatus*) EXPOSURE - SEAD-71 SOIL
SEAD-59 and SEAD-71 Phase II RI Report

COPC	Surface Soil (0-2 ft bgs)	Total Soil (0-4 ft bgs)	SP (mg COPC/kg	Terrestrial	Deer Mouse	Deer Mouse
	EPC (mg/kg)	EPC (mg/kg)	dry tissue)/(mg	Invertebrate BAF	Surface Soil	Total Soil Exposure
			COPC/kg dry soil)	(mg COPC/kg wet	Exposure	(mg/kg/day)
				tissue)/(mg	(mg/kg/day)	(mg/kg/day)
				COPC/kg dry soil)		
Semi-Volatile Organic Compounds						
2-Methylnaphthalene	19	19	1.63E-01	7.00E-02	6.50E-01	6.50E-01
Acenaphthene	42	42	2.10E-01	7.00E-02	1.52E+00	1.52E+00
Acenaphthylene	1.8	1.8	1.72E-01	7.00E-02	6.23E-02	6.23E-02
Anthracene	100	100	1.04E-01	7.00E-02	3.16E+00	3.16E+00
Benzo(a)anthracene	150	150	2.02E-02	3.00E-02	1.99E+00	1.99E+00
Benzo(a)pyrene	120	120	1.10E-02	7.00E-02	3.29E+00	3.29E+00
Benzo(b)fluoranthene	88	88	1.01E-02	7.00E-02	2.41E+00	2.41E+00
Benzo(ghi)perylene	62	62	5.70E-03	7.00E-02	1.68E+00	1.68E+00
Benzo(k)fluoranthene	130	130	1.01E-02	8.00E-02	4.03E+00	4.03E+00
Carbazole	77	77	2.74E-01	1.00E+00	2.91E+01	2.91E+01
Chrysene	150	150	1.87E-02	4.00E-02	2.52E+00	2.52E+00
Dibenz(a,h)anthracene	25	25	6.40E-03	7.00E-02	6.80E-01	6.80E-01
Dibenzofuran	38	38	1.51E-01	1.00E+00	1.41E+01	1.41E+01
Fluoranthene	440	440	3.72E-02	7.00E-02	1.26E+01	1.26E+01
Fluorene	62	62	1.49E-01	7.00E-02	2.08E+00	2.08E+00
Indeno(1,2,3-cd)pyrene	65	65	3.90E-03	8.00E-02	2.00E+00	2.00E+00
Naphthalene	46	46	4.20E-01	7.00E-02	2.10E+00	2.10E+00
Phenanthrene	290	290	1.02E-01	7.00E-02	9.13E+00	9.13E+00
Pyrene	280	280	4.43E-02	7.00E-02	8.09E+00	8.09E+00
Pesticides						
4,4'-DDD	0.24	0.24	9.37E-03	1.26E+00	1.11E-01	1.11E-01
4,4'-DDE	0.81	0.81	9.37E-03	1.26E+00	3.73E-01	3.73E-01
4,4'-DDT	1.3	1.3	9.37E-03	1.26E+00	5.99E-01	5.99E-01
Endosulfan I	0.2		1.65E-01	3.00E-01	2.36E-02	
Endosulfan sulfate	0.11	0.11	2.97E-01	3.00E-01	1.36E-02	1.36E-02
Endrin	0.12	0.12	4.61E-02	1.80E-01	8.28E-03	8.28E-03
Endrin aldehyde	0.12	0.12	6.51E-02	1.80E-01	8.38E-03	8.38E-03
Endrin ketone	0.18	0.18	4.61E-02	1.80E-01	1.24E-02	1.24E-02
Heptachlor epoxide	0.18	0.18	2.93E-02	1.30E-01	9.01E-03	9.01E-03
Methoxychlor	0.52	0.52	4.48E-02	3.06E+01	5.80E+00	5.80E+00
Inorganics						
Antimony	19.3	19.3	2.00E-01	2.20E-01	1.75E+00	1.75E+00
Arsenic	14.6	14.6	3.60E-02	1.10E-01	6.29E-01	6.29E-01

TABLE J-10C
DEER MOUSE (*Peromyscus maniculatus*) EXPOSURE - SEAD-71 SOIL
SEAD-59 and SEAD-71 Phase II RI Report

COPC	Soil Exposure		SP (mg COPC/kg dry tissue)/(mg COPC/kg dry soil)	Terrestrial Invertebrate BAF	Deer Mouse	Deer Mouse
	Surface Soil (0-2 ft bgs) EPC (mg/kg)	Total Soil (0-4 ft bgs) EPC (mg/kg)		(mg COPC/kg wet tissue)/(mg COPC/kg dry soil)	Surface Soil Exposure (mg/kg/day)	Total Soil Exposure (mg/kg/day)
Cadmium	12.1	12.1	3.64E-01	9.60E-01	4.44E+00	4.44E+00
Chromium	60.3	60.3	7.50E-03	1.00E-02	3.26E-01	3.26E-01
Cobalt	14.6	14.6	8.10E-02	1.22E-01	7.22E-01	7.22E-01
Copper	134	134	4.00E-01	4.00E-02	4.54E+00	4.54E+00
Lead	3470	3470	4.50E-02	3.00E-02	4.99E+01	4.99E+01
Manganese	1330	1330	2.50E-01	5.40E-02	4.29E+01	4.29E+01
Mercury	2.7	2.7	3.75E-02	4.00E-02	4.77E-02	4.77E-02
Nickel	110	110	3.20E-02	2.00E-02	1.12E+00	1.12E+00
Selenium	1.8	1.8	1.60E-02	2.20E-01	1.48E-01	1.48E-01
Silver	2.2	2.2	4.00E-01	2.20E-01	2.19E-01	2.19E-01
Thallium	2.3	2.3	4.00E-03	2.20E-01	1.88E-01	1.88E-01
Vanadium	29.2	29.2	5.50E-03	2.20E-01	2.39E+00	2.39E+00
Zinc	3660	3660	1.20E-12	5.60E-01	7.51E+02	7.51E+02

COPC = Constituent of Potential Concern

EPC = Exposure Point Concentration, the maximum detected concentration

BAF = Bioaccumulation Factor (unitless)

SP = Soil to plant uptake factor (unitless)

(1) Exposure = $[(Cs*SP*CF*PDF*FR) + (Cs*IDF*BAF*FR) + (Cs*Is)*SFF]/BW$

Cs = EPC in the appropriate soil exposure interval (mg COPC/kg dry soil)

SP = Soil-to-plant uptake factor ((mg COPC/kg dry tissue)/(mg COPC/kg dry soil))

CF = Dry weight to wet weight plant matter conversion factor = 0.2 (unitless)

PDF = Plant dietary fraction (unitless)

FR = Feeding rate (kg/day)

IDF = Invertebrate dietary fraction (unitless)

Is = Soil dietary (kg dry/day)

SFF = Site foraging frequency = 1 (unitless)

BW = Body weight (kg)

TABLE J-10D
DEER MOUSE (*Peromyscus maniculatus*) EXPOSURE - SEAD-71 Soil (Fenced Area Excluded)
SEAD-59 and SEAD-71 Phase II RI Report

COPC	Surface Soil (0-2 ft bgs) EPC (mg/kg)	Total Soil (0-4 ft bgs) EPC (mg/kg)	SP (mg COPC/kg dry tissue)/(mg COPC/kg dry soil)	Terrestrial	Deer Mouse Surface Soil Exposure (mg/kg/day)	Deer Mouse Total Soil Exposure (mg/kg/day)
				Invertebrate BAF (mg COPC/kg wet tissue)/(mg COPC/kg dry soil)		
Semi-Volatile Organic Compounds						
2-Methylnaphthalene	0.77	0.77	1.63E-01	7.00E-02	2.63E-02	2.63E-02
Acenaphthene	5.8	5.8	2.10E-01	7.00E-02	2.10E-01	2.10E-01
Acenaphthylene	1.8	1.8	1.72E-01	7.00E-02	6.23E-02	6.23E-02
Anthracene	11	11	1.04E-01	7.00E-02	3.47E-01	3.47E-01
Benzo(a)anthracene	37	37	2.02E-02	3.00E-02	4.91E-01	4.91E-01
Benzo(a)pyrene	22	22	1.10E-02	7.00E-02	6.03E-01	6.03E-01
Benzo(b)fluoranthene	26	26	1.01E-02	7.00E-02	7.12E-01	7.12E-01
Benzo(ghi)perylene	10	10	5.70E-03	7.00E-02	2.72E-01	2.72E-01
Benzo(k)fluoranthene	15	15	1.01E-02	8.00E-02	4.65E-01	4.65E-01
Carbazole	9.5	9.5	2.74E-01	1.00E+00	3.59E+00	3.59E+00
Chrysene	36	36	1.87E-02	4.00E-02	6.06E-01	6.06E-01
Dibenz(a,h)anthracene	9.8	9.8	6.40E-03	7.00E-02	2.67E-01	2.67E-01
Dibenzofuran	1.4	1.4	1.51E-01	1.00E+00	5.21E-01	5.21E-01
Fluoranthene	88	88	3.72E-02	7.00E-02	2.51E+00	2.51E+00
Fluorene	2.8	2.8	1.49E-01	7.00E-02	9.40E-02	9.40E-02
Indeno(1,2,3-cd)pyrene	12	12	3.90E-03	8.00E-02	3.69E-01	3.69E-01
Naphthalene	1.1	1.1	4.20E-01	7.00E-02	5.02E-02	5.02E-02
Phenanthrene	66	66	1.02E-01	7.00E-02	2.08E+00	2.08E+00
Pyrene	63	63	4.43E-02	7.00E-02	1.82E+00	1.82E+00
Pesticides						
4,4'-DDD	0.017	0.017	9.37E-03	1.26E+00	7.83E-03	7.83E-03
4,4'-DDE	0.19	0.19	9.37E-03	1.26E+00	8.75E-02	8.75E-02
4,4'-DDT	0.12	0.12	9.37E-03	1.26E+00	5.53E-02	5.53E-02
Endosulfan I	0.2	0.2	1.65E-01	3.00E-01	2.36E-02	2.36E-02
Endosulfan sulfate	0.0046	0.0046	2.97E-01	3.00E-01	5.70E-04	5.70E-04
Endrin	0.029	0.029	4.61E-02	1.80E-01	2.00E-03	2.00E-03
Endrin aldehyde	0.0091	0.0091	6.51E-02	1.80E-01	6.36E-04	6.36E-04
Endrin ketone	0.017	0.017	4.61E-02	1.80E-01	1.17E-03	1.17E-03
Heptachlor epoxide	0.0064	0.0064	2.93E-02	1.30E-01	3.20E-04	3.20E-04
Methoxychlor	0.062	0.062	4.48E-02	3.06E+01	6.91E-01	6.91E-01
Inorganics						
Antimony	11.5	11.5	2.00E-01	2.20E-01	1.04E+00	1.04E+00
Arsenic	14.6	14.6	3.60E-02	1.10E-01	6.29E-01	6.29E-01

TABLE J-10D
DEER MOUSE (*Peromyscus maniculatus*) EXPOSURE - SEAD-71 Soil (Fenced Area Excluded)
SEAD-59 and SEAD-71 Phase II RI Report

COPC	Surface Soil (0-2 ft bgs) EPC (mg/kg)	Total Soil (0-4 ft bgs) EPC (mg/kg)	SP (mg COPC/kg dry tissue)/(mg COPC/kg dry soil)	Terrestrial	Deer Mouse Surface Soil Exposure (mg/kg/day)	Deer Mouse Total Soil Exposure (mg/kg/day)
				Invertebrate BAF (mg COPC/kg wet tissue)/(mg COPC/kg dry soil)		
Cadmium	0.71	0.71	3.64E-01	9.60E-01	2.61E-01	2.61E-01
Chromium	37.1	37.1	7.50E-03	1.00E-02	2.01E-01	2.01E-01
Cobalt	13.9	13.9	8.10E-02	1.22E-01	6.87E-01	6.87E-01
Copper	102	102	4.00E-01	4.00E-02	3.45E+00	3.45E+00
Lead	1010	1010	4.50E-02	3.00E-02	1.45E+01	1.45E+01
Manganese	1330	1330	2.50E-01	5.40E-02	4.29E+01	4.29E+01
Mercury	1	1	3.75E-02	4.00E-02	1.77E-02	1.77E-02
Nickel	110	110	3.20E-02	2.00E-02	1.12E+00	1.12E+00
Selenium	1.8	1.8	1.60E-02	2.20E-01	1.48E-01	1.48E-01
Silver	1.8	1.8	4.00E-01	2.20E-01	1.79E-01	1.79E-01
Thallium	2.3	2.3	4.00E-03	2.20E-01	1.88E-01	1.88E-01
Vanadium	24	24	5.50E-03	2.20E-01	1.96E+00	1.96E+00
Zinc	1740	1740	1.20E-12	5.60E-01	3.57E+02	3.57E+02

COPC = Constituent of Potential Concern

EPC = Exposure Point Concentration, the maximum detected concentration

BAF = Bioaccumulation Factor (unitless)

SP = Soil to plant uptake factor (unitless)

(1) Exposure = $\frac{((Cs * SP * CF * PDF * FR) + (Cs * IDF * BAF * FR) + (Cs * Is)) * SFF}{BW}$

Cs = EPC in the appropriate soil exposure interval (mg COPC/kg dry soil)

SP = Soil-to-plant uptake factor ((mg COPC/kg dry tissue)/(mg COPC/kg dry soil))

CF = Dry weight to wet weight plant matter conversion factor = 0.2 (unitless)

PDF = Plant dietary fraction (unitless)

FR = Feeding rate (kg/day)

IDF = Invertebrate dietary fraction (unitless)

Is = Soil dietary (kg dry/day)

SFF = Site foraging frequency = 1 (unitless)

BW = Body weight (kg)

TABLE J-11A
AMERICAN ROBIN (*Turdus migratorius*) EXPOSURE - SEAD-59
SEAD-59 and SEAD-71 Phase II RI Report

COPC	Surface Soil (0-2 ft bgs) EPC (mg/kg)	Total Soil (0-4 ft bgs) EPC (mg/kg)	Soil-To-Plant Uptake Factor (mg COPC/kg dry tissue)/(mg COPC/kg dry soil)	Soil-To-Soil Invertebrate BAF (mg COPC/kg wet tissue)/(mg COPC/kg dry soil)	American Robin Surface Soil Exposure (mg/kg/day)	American Robin Total Soil Exposure (mg/kg/day)
Semi-Volatile Organic Compounds						
2-Methylnaphthalene		10	1.63E-01	7.00E-02	0.00E+00	4.42E-01
Acenaphthene	2.68	2.68	2.10E-01	7.00E-02	1.19E-01	1.19E-01
Acenaphthylene	1.7	1.7	1.72E-01	7.00E-02	7.53E-02	7.53E-02
Anthracene	4.395	4.395	1.04E-01	7.00E-02	1.93E-01	1.93E-01
Benzo(a)anthracene	8.9	8.9	2.02E-02	3.00E-02	2.39E-01	2.39E-01
Benzo(a)pyrene	8.05	8.05	1.10E-02	7.00E-02	3.48E-01	3.48E-01
Benzo(b)fluoranthene	6.8	6.8	1.01E-02	7.00E-02	2.94E-01	2.94E-01
Benzo(ghi)perylene	5.2	5.2	5.70E-03	7.00E-02	2.25E-01	2.25E-01
Benzo(k)fluoranthene	7.35	7.35	1.01E-02	8.00E-02	3.48E-01	3.48E-01
Carbazole	0.755	0.755	2.74E-01	1.00E+00	3.24E-01	3.24E-01
Chrysene	8.9	8.9	1.87E-02	4.00E-02	2.75E-01	2.75E-01
Dibenz(a,h)anthracene	1.665	1.665	6.40E-03	7.00E-02	7.20E-02	7.20E-02
Dibenzofuran	1.875	1.875	1.51E-01	1.00E+00	8.03E-01	8.03E-01
Fluoranthene	23.5	23.5	3.72E-02	7.00E-02	1.02E+00	1.02E+00
Fluorene	2.64	3	1.49E-01	7.00E-02	1.17E-01	1.32E-01
Indeno(1,2,3-cd)pyrene	4.95	4.95	3.90E-03	8.00E-02	2.34E-01	2.34E-01
Naphthalene	1.325	1.325	4.20E-01	7.00E-02	6.07E-02	6.07E-02
Phenanthrene	21.3	21.3	1.02E-01	7.00E-02	9.34E-01	9.34E-01
Pyrene	19.2	19.2	4.43E-02	7.00E-02	8.35E-01	8.35E-01
Pesticides						
4,4'-DDD	0.74	0.74	9.37E-03	1.26E+00	3.96E-01	3.96E-01
4,4'-DDE	2.6	2.6	9.37E-03	1.26E+00	1.39E+00	1.39E+00
4,4'-DDT	3.7	3.7	9.37E-03	1.26E+00	1.98E+00	1.98E+00
Metals						
Antimony	424	424	2.00E-01	2.20E-01	4.51E+01	4.51E+01
Arsenic	32.2	32.2	3.60E-02	1.10E-01	1.93E+00	1.93E+00
Cadmium	3.2	3.2	3.64E-01	9.60E-01	1.32E+00	1.32E+00
Chromium	39.3	39.3	7.50E-03	1.00E-02	7.26E-01	7.26E-01
Cobalt	47.8	47.8	8.10E-02	1.22E-01	3.12E+00	3.12E+00
Copper	305	305	4.00E-01	4.00E-02	1.02E+01	1.02E+01
Lead	164	164	4.50E-02	3.00E-02	4.42E+00	4.42E+00
Manganese	1290	1290	2.50E-01	5.40E-02	4.92E+01	4.92E+01
Mercury	0.95	0.95	3.75E-02	4.00E-02	2.95E-02	2.95E-02
Nickel	88.3	88.3	3.20E-02	2.00E-02	2.01E+00	2.01E+00
Selenium	1.5	1.5	1.60E-02	2.20E-01	1.58E-01	1.58E-01
Silver	2.9	2.9	4.00E-01	2.20E-01	3.12E-01	3.12E-01
Thallium	1.8	1.8	4.00E-03	2.20E-01	1.89E-01	1.89E-01
Vanadium	28.5	28.5	5.50E-03	2.20E-01	3.00E+00	3.00E+00
Zinc	341	341	1.20E-12	5.60E-01	8.37E+01	8.37E+01

COPC = Constituent of Potential Concern

EPC = Exposure Point Concentration, the maximum detected concentration

BAF = Bioaccumulation Factor (unitless)

SP = Soil to plant uptake factor (unitless)

(1) Exposure = $[(Cs*SP*CF*PDF*FR) + (Cs*IDF*BAF*FR) + (Cs*Is)]*SFF/BW$

Cs = Soil concentration (mg/kg)

SP = Soil to plant uptake factor from literature

CF = Dry weight to wet weight plant matter conversion factor = 0.2 (unitless)

PDF = Plant dietary fraction (unitless)

FR = Feeding rate (kg/day)

IDF = Invertebrate dietary fraction (unitless)

Is = Soil dietary (kg dry/day)

SFF = Site foraging frequency = 1 (unitless)

BW = Body weight (kg)

TABLE J-11B
AMERICAN ROBIN (*Turdus migratorius*) EXPOSURE - SEAD-59 STOCKPILE SOIL
SEAD-59 AND SEAD-71 PHASE II RI REPORT

COPC	SEAD-59 Stockpile Soil EPC (mg/kg)	Soil-To-Plant Uptake Factor (mg COPC/kg dry tissue)/(mg COPC/kg dry soil)	Soil-To-Soil Invertebrate BAF (mg COPC/kg wet tissue)/(mg COPC/kg dry soil)	American Robin Stockpile Soil Exposure (mg/kg/day)
Semi-Volatile Organic Compounds				
Acenaphthylene	3.5	1.72E-01	7.00E-02	1.55E-01
Anthracene	6.6	1.04E-01	7.00E-02	2.89E-01
Benzo(a)anthracene	14	2.02E-02	3.00E-02	3.75E-01
Benzo(a)pyrene	16	1.10E-02	7.00E-02	6.92E-01
Benzo(b)fluoranthene	11	1.01E-02	7.00E-02	4.76E-01
Benzo(ghi)perylene	8	5.70E-03	7.00E-02	3.46E-01
Benzo(k)fluoranthene	13	1.01E-02	8.00E-02	6.16E-01
Carbazole	1.1	2.74E-01	1.00E+00	4.72E-01
Chrysene	13	1.87E-02	4.00E-02	4.02E-01
Dibenz(a,h)anthracene	2.9	6.40E-03	7.00E-02	1.25E-01
Dibenzofuran	1.3	1.51E-01	1.00E+00	5.57E-01
Fluoranthene	29	3.72E-02	7.00E-02	1.26E+00
Fluorene	3.1	1.49E-01	7.00E-02	1.37E-01
Indeno(1,2,3-cd)pyrene	8	3.90E-03	8.00E-02	3.79E-01
Naphthalene	1.2	4.20E-01	7.00E-02	5.50E-02
Phenanthrene	17	1.02E-01	7.00E-02	7.45E-01
Pyrene	22	4.43E-02	7.00E-02	9.57E-01
Pesticides				
4,4'-DDD	0.45	9.37E-03	1.26E+00	2.41E-01
4,4'-DDE	0.23	9.37E-03	1.26E+00	1.23E-01
4,4'-DDT	0.52	9.37E-03	1.26E+00	2.78E-01
Inorganics				
Antimony	43.9	2.00E-01	2.20E-01	4.67E+00
Arsenic	7.3	3.60E-02	1.10E-01	4.38E-01
Cadmium	1.2	3.64E-01	9.60E-01	4.96E-01
Chromium	35	7.50E-03	1.00E-02	6.47E-01
Cobalt	13.9	8.10E-02	1.22E-01	9.06E-01
Copper	51.8	4.00E-01	4.00E-02	1.73E+00
Lead	1440	4.50E-02	3.00E-02	3.88E+01
Manganese	1220	2.50E-01	5.40E-02	4.65E+01
Mercury	0.52	3.75E-02	4.00E-02	1.61E-02
Nickel	56.6	3.20E-02	2.00E-02	1.29E+00
Selenium	0.72	1.60E-02	2.20E-01	7.58E-02
Silver	4.7	4.00E-01	2.20E-01	5.06E-01
Vanadium	35.4	5.50E-03	2.20E-01	3.72E+00
Zinc	185	1.20E-12	5.60E-01	4.54E+01

COPC = Constituent of Potential Concern

EPC = Exposure Point Concentration, the maximum detected concentration

BAF = Bioaccumulation Factor (unitless)

SP = Soil to plant uptake factor (unitless)

(1) Exposure = $[(Cs*SP*CF*PDF*FR) + (Cs*IDF*BAF*FR) + (Cs*Is)]*SFF/BW$

Cs = Soil concentration (mg/kg)

SP = Soil to plant uptake factor from literature

CF = Dry weight to wet weight plant matter conversion factor = 0.2 (unitless)

PDF = Plant dietary fraction (unitless)

FR = Feeding rate (kg/day)

IDF = Invertebrate dietary fraction (unitless)

Is = Soil dietary (kg dry/day)

SFF = Site foraging frequency = 1 (unitless)

BW = Body weight (kg)

TABLE J-11C
AMERICAN ROBIN (*Turdus migratorius*) EXPOSURE - SEAD-71 SOIL
SEAD-59 and SEAD-71 Phase II RI Report

COPC	Surface Soil	Total Soil (0-4 ft bgs) EPC (mg/kg)	Soil-To-Plant	Soil-To-Soil	American Robin Surface Soil Exposure (mg/kg/day)	American Robin Total Soil Exposure (mg/kg/day)
	(0-2 ft bgs) EPC (mg/kg)		Uptake Factor (mg COPC/kg dry tissue)/(mg COPC/kg dry soil)	Invertebrate BAF (mg COPC/kg wet tissue)/(mg COPC/kg dry soil)		
Semi-Volatile Organic Compounds						
2-Methylnaphthalene	19	19	1.63E-01	7.00E-02	8.40E-01	8.40E-01
Acenaphthene	42	42	2.10E-01	7.00E-02	1.87E+00	1.87E+00
Acenaphthylene	1.8	1.8	1.72E-01	7.00E-02	7.97E-02	7.97E-02
Anthracene	100	100	1.04E-01	7.00E-02	4.39E+00	4.39E+00
Benzo(a)anthracene	150	150	2.02E-02	3.00E-02	4.02E+00	4.02E+00
Benzo(a)pyrene	120	120	1.10E-02	7.00E-02	5.19E+00	5.19E+00
Benzo(b)fluoranthene	88	88	1.01E-02	7.00E-02	3.81E+00	3.81E+00
Benzo(ghi)perylene	62	62	5.70E-03	7.00E-02	2.68E+00	2.68E+00
Benzo(k)fluoranthene	130	130	1.01E-02	8.00E-02	6.16E+00	6.16E+00
Carbazole	77	77	2.74E-01	1.00E+00	3.30E+01	3.30E+01
Chrysene	150	150	1.87E-02	4.00E-02	4.64E+00	4.64E+00
Dibenz(a,h)anthracene	25	25	6.40E-03	7.00E-02	1.08E+00	1.08E+00
Dibenzofuran	38	38	1.51E-01	1.00E+00	1.63E+01	1.63E+01
Fluoranthene	440	440	3.72E-02	7.00E-02	1.91E+01	1.91E+01
Fluorene	62	62	1.49E-01	7.00E-02	2.74E+00	2.74E+00
Indeno(1,2,3-cd)pyrene	65	65	3.90E-03	8.00E-02	3.08E+00	3.08E+00
Naphthalene	46	46	4.20E-01	7.00E-02	2.11E+00	2.11E+00
Phenanthrene	290	290	1.02E-01	7.00E-02	1.27E+01	1.27E+01
Pyrene	280	280	4.43E-02	7.00E-02	1.22E+01	1.22E+01
Pesticides						
4,4'-DDD	0.24	0.24	9.37E-03	1.26E+00	1.28E-01	1.28E-01
4,4'-DDE	0.81	0.81	9.37E-03	1.26E+00	4.33E-01	4.33E-01
4,4'-DDT	1.3	1.3	9.37E-03	1.26E+00	6.95E-01	6.95E-01
Endosulfan I	0.2		1.65E-01	3.00E-01	2.78E-02	0.00E+00
Endosulfan sulfate	0.11	0.11	2.97E-01	3.00E-01	1.54E-02	1.54E-02
Endrin	0.12	0.12	4.61E-02	1.80E-01	1.07E-02	1.07E-02
Endrin aldehyde	0.12	0.12	6.51E-02	1.80E-01	1.07E-02	1.07E-02
Endrin ketone	0.18	0.18	4.61E-02	1.80E-01	1.60E-02	1.60E-02
Heptachlor epoxide	0.18	0.18	2.93E-02	1.30E-01	1.23E-02	1.23E-02
Methoxychlor	0.52	0.52	4.48E-02	3.06E+01	6.58E+00	6.58E+00
Inorganics						
Antimony	19.3	19.3	2.00E-01	2.20E-01	2.05E+00	2.05E+00
Arsenic	14.6	14.6	3.60E-02	1.10E-01	8.75E-01	8.75E-01
Cadmium	12.1	12.1	3.64E-01	9.60E-01	5.00E+00	5.00E+00

TABLE J-11C
AMERICAN ROBIN (*Turdus migratorius*) EXPOSURE - SEAD-71 SOIL
SEAD-59 and SEAD-71 Phase II RI Report

COPC	Surface Soil (0-2 ft bgs)		Soil-To-Plant Uptake Factor	Soil-To-Soil Invertebrate BAF	American Robin Surface Soil Exposure	American Robin Total Soil Exposure
	EPC (mg/kg)	Total Soil (0-4 ft bgs) EPC (mg/kg)	(mg COPC/kg dry tissue)/(mg COPC/kg dry soil)	(mg COPC/kg wet tissue)/(mg COPC/kg dry soil)	(mg/kg/day)	(mg/kg/day)
Chromium	60.3	60.3	7.50E-03	1.00E-02	1.11E+00	1.11E+00
Cobalt	14.6	14.6	8.10E-02	1.22E-01	9.52E-01	9.52E-01
Copper	134	134	4.00E-01	4.00E-02	4.46E+00	4.46E+00
Lead	3470	3470	4.50E-02	3.00E-02	9.36E+01	9.36E+01
Manganese	1330	1330	2.50E-01	5.40E-02	5.07E+01	5.07E+01
Mercury	2.7	2.7	3.75E-02	4.00E-02	8.38E-02	8.38E-02
Nickel	110	110	3.20E-02	2.00E-02	2.50E+00	2.50E+00
Selenium	1.8	1.8	1.60E-02	2.20E-01	1.89E-01	1.89E-01
Silver	2.2	2.2	4.00E-01	2.20E-01	2.37E-01	2.37E-01
Thallium	2.3	2.3	4.00E-03	2.20E-01	2.42E-01	2.42E-01
Vanadium	29.2	29.2	5.50E-03	2.20E-01	3.07E+00	3.07E+00
Zinc	3660	3660	1.20E-12	5.60E-01	8.99E+02	8.99E+02

COPC = Constituent of Potential Concern
EPC = Exposure Point Concentration, the maximum detected concentration
BAF = Bioaccumulation Factor (unitless)
SP = Soil to plant uptake factor (unitless)
(1) Exposure = $[(Cs * SP * CF * PDF * FR) + (Cs * IDF * BAF * FR) + (Cs * Is)] * SFF / BW$
Cs = Soil concentration (mg/kg)
SP = Soil to plant uptake factor from literature
CF = Dry weight to wet weight plant matter conversion factor = 0.2 (unitless)
PDF = Plant dietary fraction (unitless)
FR = Feeding rate (kg/day)
IDF = Invertebrate dietary fraction (unitless)
Is = Soil dietary (kg dry/day)
SFF = Site foraging frequency = 1 (unitless)
BW = Body weight (kg)

TABLE J-11D
AMERICAN ROBIN (*Turdus migratorius*) EXPOSURE - SEAD-71 Soil (Fenced Area Excluded)
SEAD-59 and SEAD-71 Phase II RI Report

COPC	Surface Soil (0-2 ft bgs)	Total Soil (0-4 ft bgs) EPC (mg/kg)	Soil-To-Plant Uptake Factor (mg COPC/kg dry tissue)/(mg COPC/kg dry soil)	Soil-To-Soil Invertebrate BAF (mg COPC/kg wet tissue)/(mg COPC/kg dry soil)	American Robin Surface Soil Exposure (mg/kg/day)	American Robin Total Soil Exposure (mg/kg/day)
	EPC (mg/kg)					
Semi-Volatile Organic Compounds						
2-Methylnaphthalene	0.77	0.77	1.63E-01	7.00E-02	3.40E-02	3.40E-02
Acenaphthene	5.8	5.8	2.10E-01	7.00E-02	2.58E-01	2.58E-01
Acenaphthylene	1.8	1.8	1.72E-01	7.00E-02	7.97E-02	7.97E-02
Anthracene	11	11	1.04E-01	7.00E-02	4.82E-01	4.82E-01
Benzo(a)anthracene	37	37	2.02E-02	3.00E-02	9.92E-01	9.92E-01
Benzo(a)pyrene	22	22	1.10E-02	7.00E-02	9.52E-01	9.52E-01
Benzo(b)fluoranthene	26	26	1.01E-02	7.00E-02	1.12E+00	1.12E+00
Benzo(ghi)perylene	10	10	5.70E-03	7.00E-02	4.32E-01	4.32E-01
Benzo(k)fluoranthene	15	15	1.01E-02	8.00E-02	7.11E-01	7.11E-01
Carbazole	9.5	9.5	2.74E-01	1.00E+00	4.07E+00	4.07E+00
Chrysene	36	36	1.87E-02	4.00E-02	1.11E+00	1.11E+00
Dibenz(a,h)anthracene	9.8	9.8	6.40E-03	7.00E-02	4.24E-01	4.24E-01
Dibenzofuran	1.4	1.4	1.51E-01	1.00E+00	5.99E-01	5.99E-01
Fluoranthene	88	88	3.72E-02	7.00E-02	3.82E+00	3.82E+00
Fluorene	2.8	2.8	1.49E-01	7.00E-02	1.24E-01	1.24E-01
Indeno(1,2,3-cd)pyrene	12	12	3.90E-03	8.00E-02	5.68E-01	5.68E-01
Naphthalene	1.1	1.1	4.20E-01	7.00E-02	5.04E-02	5.04E-02
Phenanthrene	66	66	1.02E-01	7.00E-02	2.89E+00	2.89E+00
Pyrene	63	63	4.43E-02	7.00E-02	2.74E+00	2.74E+00
Pesticides						
4,4'-DDD	0.017	0.017	9.37E-03	1.26E+00	9.09E-03	9.09E-03
4,4'-DDE	0.19	0.19	9.37E-03	1.26E+00	1.02E-01	1.02E-01
4,4'-DDT	0.12	0.12	9.37E-03	1.26E+00	6.42E-02	6.42E-02
Endosulfan I	0.2	0.2	1.65E-01	3.00E-01	2.78E-02	2.78E-02
Endosulfan sulfate	0.0046	0.0046	2.97E-01	3.00E-01	6.44E-04	6.44E-04
Endrin	0.029	0.029	4.61E-02	1.80E-01	2.58E-03	2.58E-03
Endrin aldehyde	0.0091	0.0091	6.51E-02	1.80E-01	8.10E-04	8.10E-04
Endrin ketone	0.017	0.017	4.61E-02	1.80E-01	1.51E-03	1.51E-03
Heptachlor epoxide	0.0064	0.0064	2.93E-02	1.30E-01	4.36E-04	4.36E-04
Methoxychlor	0.062	0.062	4.48E-02	3.06E+01	7.85E-01	7.85E-01
Inorganics						
Antimony	11.5	11.5	2.00E-01	2.20E-01	1.22E+00	1.22E+00
Arsenic	14.6	14.6	3.60E-02	1.10E-01	8.75E-01	8.75E-01

TABLE J-11D
AMERICAN ROBIN (*Turdus migratorius*) EXPOSURE - SEAD-71 Soil (Fenced Area Excluded)
SEAD-59 and SEAD-71 Phase II RI Report

COPC	Surface Soil (0-2 ft bgs)		Soil-To-Plant Uptake Factor	Soil-To-Soil Invertebrate BAF	American Robin Surface Soil Exposure	American Robin Total Soil Exposure
	EPC (mg/kg)	Total Soil (0-4 ft bgs) EPC (mg/kg)	(mg COPC/kg dry tissue)/(mg COPC/kg dry soil)	(mg COPC/kg wet tissue)/(mg COPC/kg dry soil)	(mg/kg/day)	(mg/kg/day)
Cadmium	0.71	0.71	3.64E-01	9.60E-01	2.93E-01	2.93E-01
Chromium	37.1	37.1	7.50E-03	1.00E-02	6.85E-01	6.85E-01
Cobalt	13.9	13.9	8.10E-02	1.22E-01	9.06E-01	9.06E-01
Copper	102	102	4.00E-01	4.00E-02	3.40E+00	3.40E+00
Lead	1010	1010	4.50E-02	3.00E-02	2.72E+01	2.72E+01
Manganese	1330	1330	2.50E-01	5.40E-02	5.07E+01	5.07E+01
Mercury	1	1	3.75E-02	4.00E-02	3.10E-02	3.10E-02
Nickel	110	110	3.20E-02	2.00E-02	2.50E+00	2.50E+00
Selenium	1.8	1.8	1.60E-02	2.20E-01	1.89E-01	1.89E-01
Silver	1.8	1.8	4.00E-01	2.20E-01	1.94E-01	1.94E-01
Thallium	2.3	2.3	4.00E-03	2.20E-01	2.42E-01	2.42E-01
Vanadium	24	24	5.50E-03	2.20E-01	2.52E+00	2.52E+00
Zinc	1740	1740	1.20E-12	5.60E-01	4.27E+02	4.27E+02

COPC = Constituent of Potential Concern
EPC = Exposure Point Concentration, the maximum detected concentration
BAF = Bioaccumulation Factor (unitless)
SP = Soil to plant uptake factor (unitless)
(1) Exposure = $[(Cs * SP * CF * PDF * FR) + (Cs * IDF * BAF * FR) + (Cs * Is)] * SFF / BW$
Cs = Soil concentration (mg/kg)
SP = Soil to plant uptake factor from literature
CF = Dry weight to wet weight plant matter conversion factor = 0.2 (unitless)
PDF = Plant dietary fraction (unitless)
FR = Feeding rate (kg/day)
IDF = Invertebrate dietary fraction (unitless)
Is = Soil dietary (kg dry/day)
SFF = Site foraging frequency = 1 (unitless)
BW = Body weight (kg)

TABLE J-12A
Short-Tailed Shrew (*Blarina brevicauda*) Exposure - SEAD-59
SEAD-59 and SEAD-71 Phase II RI Report

COPC	Surface Soil (0-2 ft bgs)		Soil-To-Plant (mg COPC/kg dry tissue)/(mg COPC/kg dry soil)	Soil-To-Soil Invertebrate BAF (mg COPC/kg wet tissue)/(mg COPC/kg dry soil)	Small Mammal BAF (mg COPC/kg wet tissue)/(mg COPC/kg dry soil)	Short-Tailed Shrew Surface Soil Exposure (mg/kg/day)	Short-Tailed Shrew Total Soil Exposure (mg/kg/day)
	EPC (mg/kg)	Total Soil (0-4 ft bgs) EPC (mg/kg)					
Semi-Volatile Organic Compounds							
2-Methylnaphthalene		10	1.63E-01	7.00E-02	4.61E-04	0.00E+00	5.23E-01
Acenaphthene	2.68	2.68	2.10E-01	7.00E-02	4.61E-04	1.41E-01	1.41E-01
Acenaphthylene	1.7	1.7	1.72E-01	7.00E-02	4.61E-04	8.89E-02	8.89E-02
Anthracene	4.395	4.395	1.04E-01	7.00E-02	4.61E-04	2.28E-01	2.28E-01
Benzo(a)anthracene	8.9	8.9	2.02E-02	3.00E-02	1.46E-04	2.66E-01	2.66E-01
Benzo(a)pyrene	8.05	8.05	1.10E-02	7.00E-02	4.61E-04	4.12E-01	4.12E-01
Benzo(b)fluoranthene	6.8	6.8	1.01E-02	7.00E-02	5.46E-04	3.48E-01	3.48E-01
Benzo(ghi)perylene	5.2	5.2	5.70E-03	7.00E-02	4.61E-04	2.66E-01	2.66E-01
Benzo(k)fluoranthene	7.35	7.35	1.01E-02	8.00E-02	5.43E-04	4.16E-01	4.16E-01
Carbazole	0.755	0.755	2.74E-01	1.00E+00	6.29E-01	4.40E-01	4.40E-01
Chrysene	8.9	8.9	1.87E-02	4.00E-02	1.88E-04	3.13E-01	3.13E-01
Dibenz(a,h)anthracene	1.665	1.665	6.40E-03	7.00E-02	1.21E-03	8.53E-02	8.53E-02
Dibenzofuran	1.875	1.875	1.51E-01	1.00E+00	5.50E-01	1.08E+00	1.08E+00
Fluoranthene	23.5	23.5	3.72E-02	7.00E-02	4.61E-04	1.21E+00	1.21E+00
Fluorene	2.64	3	1.49E-01	7.00E-02	4.61E-04	1.38E-01	1.56E-01
Indeno(1,2,3-cd)pyrene	4.95	4.95	3.90E-03	8.00E-02	2.82E-03	2.81E-01	2.81E-01
Naphthalene	1.325	1.325	4.20E-01	7.00E-02	4.61E-04	7.15E-02	7.15E-02
Phenanthrene	21.3	21.3	1.02E-01	7.00E-02	4.61E-04	1.10E+00	1.10E+00
Pyrene	19.2	19.2	4.43E-02	7.00E-02	4.61E-04	9.88E-01	9.88E-01
Pesticides							
4,4'-DDD	0.74	0.74	9.37E-03	1.26E+00	6.18E-04	5.10E-01	5.10E-01
4,4'-DDE	2.6	2.6	9.37E-03	1.26E+00	6.18E-04	1.79E+00	1.79E+00
4,4'-DDT	3.7	3.7	9.37E-03	1.26E+00	6.18E-04	2.55E+00	2.55E+00
Metals							
Antimony	424	424	2.00E-01	2.20E-01	1.00E-03	5.64E+01	5.64E+01
Arsenic	32.2	32.2	3.60E-02	1.10E-01	2.00E-03	2.35E+00	2.35E+00
Cadmium	3.2	3.2	3.64E-01	9.60E-01	5.50E-04	1.70E+00	1.70E+00
Chromium	39.3	39.3	7.50E-03	1.00E-02	5.50E-03	7.58E-01	7.58E-01
Cobalt	47.8	47.8	8.10E-02	1.22E-01	2.00E-02	3.85E+00	3.85E+00
Copper	305	305	4.00E-01	4.00E-02	1.00E-02	1.17E+01	1.17E+01
Lead	164	164	4.50E-02	3.00E-02	3.00E-04	4.92E+00	4.92E+00
Manganese	1290	1290	2.50E-01	5.40E-02	4.00E-04	5.71E+01	5.71E+01
Mercury	0.95	0.95	3.75E-02	4.00E-02	2.50E-01	4.55E-02	4.55E-02
Nickel	88.3	88.3	3.20E-02	2.00E-02	6.00E-03	2.19E+00	2.19E+00
Selenium	1.5	1.5	1.60E-02	2.20E-01	1.50E-02	1.99E-01	1.99E-01
Silver	2.9	2.9	4.00E-01	2.20E-01	3.00E-03	3.90E-01	3.90E-01
Thallium	1.8	1.8	4.00E-03	2.20E-01	4.00E-02	2.41E-01	2.41E-01
Vanadium	28.5	28.5	5.50E-03	2.20E-01	2.50E-03	3.75E+00	3.75E+00
Zinc	341	341	1.20E-12	5.60E-01	1.00E-01	1.09E+02	1.09E+02

COPC = Constituent of Potential Concern

EPC = Exposure Point Concentration, the maximum detected concentration

BAF = Bioaccumulation Factor (unitless)

(1) Exposure = $\frac{[(Cs \cdot SP \cdot CF \cdot PDF \cdot FR) + (Cs \cdot IDF \cdot BAF \cdot FR) + (Cs \cdot ADF \cdot BAF \cdot FR) + (Cs \cdot Is)] \cdot SFF}{BW}$

Cs = Soil concentration (mg/kg)

SP = Soil to plant uptake factor from literature

CF = Dry weight to wet weight plant matter conversion factor = 0.2 (unitless)

PDF = Plant dietary fraction (unitless)

FR = Feeding rate (kg/day)

IDF = Invertebrate dietary fraction (unitless)

ADF = Animal dietary fraction (unitless)

Is = Soil dietary (kg/day)

SFF = Site foraging frequency = 1 (unitless)

BW = Body weight (kg)

TABLE J-12B
Short-Tailed Shrew (*Blarina brevicauda*) EXPOSURE - SEAD-59 STOCKPILE SOIL
SEAD-59 AND SEAD-71 PHASE II RI REPORT

COPC	SEAD-59 Stockpile Soil EPC (mg/kg)	Soil-To-Plant (mg COPC/kg dry tissue)/(mg COPC/kg dry soil)	Soil-To-Soil Invertebrate BAF (mg COPC/kg wet tissue)/(mg COPC/kg dry soil)	Small Mammal BAF (mg COPC/kg wet tissue)/(mg COPC/kg dry soil)	Short-Tailed Shrew Stockpile Soil Exposure (mg/kg/day)
Semi-Volatile Organic Compounds					
Acenaphthylene	3.5	1.72E-01	7.00E-02	4.61E-04	1.83E-01
Anthracene	6.6	1.04E-01	7.00E-02	4.61E-04	3.42E-01
Benzo(a)anthracene	14	2.02E-02	3.00E-02	1.46E-04	4.18E-01
Benzo(a)pyrene	16	1.10E-02	7.00E-02	4.61E-04	8.20E-01
Benzo(b)fluoranthene	11	1.01E-02	7.00E-02	5.46E-04	5.64E-01
Benzo(ghi)perylene	8	5.70E-03	7.00E-02	4.61E-04	4.10E-01
Benzo(k)fluoranthene	13	1.01E-02	8.00E-02	5.43E-04	7.36E-01
Carbazole	1.1	2.74E-01	1.00E+00	6.29E-01	6.42E-01
Chrysene	13	1.87E-02	4.00E-02	1.88E-04	4.57E-01
Dibenz(a,h)anthracene	2.9	6.40E-03	7.00E-02	1.21E-03	1.49E-01
Dibenzofuran	1.3	1.51E-01	1.00E+00	5.50E-01	7.52E-01
Fluoranthene	29	3.72E-02	7.00E-02	4.61E-04	1.49E+00
Fluorene	3.1	1.49E-01	7.00E-02	4.61E-04	1.62E-01
Indeno(1,2,3-cd)pyrene	8	3.90E-03	8.00E-02	2.82E-03	4.53E-01
Naphthalene	1.2	4.20E-01	7.00E-02	4.61E-04	6.48E-02
Phenanthrene	17	1.02E-01	7.00E-02	4.61E-04	8.81E-01
Pyrene	22	4.43E-02	7.00E-02	4.61E-04	1.13E+00
Pesticides					
4,4'-DDD	0.45	9.37E-03	1.26E+00	6.18E-04	3.10E-01
4,4'-DDE	0.23	9.37E-03	1.26E+00	6.18E-04	1.59E-01
4,4'-DDT	0.52	9.37E-03	1.26E+00	6.18E-04	3.59E-01
Inorganics					
Antimony	43.9	2.00E-01	2.20E-01	1.00E-03	5.84E+00
Arsenic	7.3	3.60E-02	1.10E-01	2.00E-03	5.32E-01
Cadmium	1.2	3.64E-01	9.60E-01	5.50E-04	6.37E-01
Chromium	35	7.50E-03	1.00E-02	5.50E-03	6.75E-01
Cobalt	13.9	8.10E-02	1.22E-01	2.00E-02	1.12E+00
Copper	51.8	4.00E-01	4.00E-02	1.00E-02	1.98E+00
Lead	1440	4.50E-02	3.00E-02	3.00E-04	4.32E+01
Manganese	1220	2.50E-01	5.40E-02	4.00E-04	5.40E+01
Mercury	0.52	3.75E-02	4.00E-02	2.50E-01	2.49E-02
Nickel	56.6	3.20E-02	2.00E-02	6.00E-03	1.41E+00
Selenium	0.72	1.60E-02	2.20E-01	1.50E-02	9.54E-02
Silver	4.7	4.00E-01	2.20E-01	3.00E-03	6.32E-01
Vanadium	35.4	5.50E-03	2.20E-01	2.50E-03	4.66E+00
Zinc	185	1.20E-12	5.60E-01	1.00E-01	5.90E+01

COPC = Constituent of Potential Concern

EPC = Exposure Point Concentration, the maximum detected concentration

BAF = Bioaccumulation Factor (unitless)

(1) Exposure = $[(C_s * SP * CF * PDF * FR) + (C_s * IDF * BAF * FR) + (C_s * ADF * BAF * FR) + (C_s * I_s) * SFF] / BW$

Cs = Soil concentration (mg/kg)

SP = Soil to plant uptake factor from literature

CF = Dry weight to wet weight plant matter conversion factor = 0.2 (unitless)

PDF = Plant dietary fraction (unitless)

FR = Feeding rate (kg/day)

IDF = Invertebrate dietary fraction (unitless)

ADF = Animal dietary fraction (unitless)

I_s = Soil dietary (kg/day)

SFF = Site foraging frequency = 1 (unitless)

BW = Body weight (kg)

TABLE J-12C
SHORT-TAILED SHREW (*Blarina brevicauda*) EXPOSURE - SEAD-71 SOIL
SEAD-59 and SEAD-71 Phase II RI Report

COPC	Surface Soil (0-2 ft bgs)		Soil-To-Plant (mg COPC/kg dry tissue)/(mg COPC/kg dry soil)	Soil-To-Soil Invertebrate BAF (mg COPC/kg wet tissue)/(mg COPC/kg dry soil)	Small Mammal BAF (mg COPC/kg wet tissue)/(mg COPC/kg dry soil)	Short-Tailed Shrew Surface Soil Exposure (mg/kg/day)	Short-Tailed Shrew Total Soil Exposure (mg/kg/day)
	EPC (mg/kg)	Total Soil (0-4 ft bgs) EPC (mg/kg)					
Semi-Volatile Organic Compounds							
2-Methylnaphthalene	19	19	1.63E-01	7.00E-02	4.61E-04	9.93E-01	9.93E-01
Acenaphthene	42	42	2.10E-01	7.00E-02	4.61E-04	2.21E+00	2.21E+00
Acenaphthylene	1.8	1.8	1.72E-01	7.00E-02	4.61E-04	9.42E-02	9.42E-02
Anthracene	100	100	1.04E-01	7.00E-02	4.61E-04	5.19E+00	5.19E+00
Benzo(a)anthracene	150	150	2.02E-02	3.00E-02	1.46E-04	4.47E+00	4.47E+00
Benzo(a)pyrene	120	120	1.10E-02	7.00E-02	4.61E-04	6.15E+00	6.15E+00
Benzo(b)fluoranthene	88	88	1.01E-02	7.00E-02	5.46E-04	4.51E+00	4.51E+00
Benzo(ghi)perylene	62	62	5.70E-03	7.00E-02	4.61E-04	3.17E+00	3.17E+00
Benzo(k)fluoranthene	130	130	1.01E-02	8.00E-02	5.43E-04	7.36E+00	7.36E+00
Carbazole	77	77	2.74E-01	1.00E+00	6.29E-01	4.49E+01	4.49E+01
Chrysene	150	150	1.87E-02	4.00E-02	1.88E-04	5.28E+00	5.28E+00
Dibenz(a,h)anthracene	25	25	6.40E-03	7.00E-02	1.21E-03	1.28E+00	1.28E+00
Dibenzofuran	38	38	1.51E-01	1.00E+00	5.50E-01	2.20E+01	2.20E+01
Fluoranthene	440	440	3.72E-02	7.00E-02	4.61E-04	2.26E+01	2.26E+01
Fluorene	62	62	1.49E-01	7.00E-02	4.61E-04	3.23E+00	3.23E+00
Indeno(1,2,3-cd)pyrene	65	65	3.90E-03	8.00E-02	2.82E-03	3.68E+00	3.68E+00
Naphthalene	46	46	4.20E-01	7.00E-02	4.61E-04	2.48E+00	2.48E+00
Phenanthrene	290	290	1.02E-01	7.00E-02	4.61E-04	1.50E+01	1.50E+01
Pyrene	280	280	4.43E-02	7.00E-02	4.61E-04	1.44E+01	1.44E+01
Pesticides							
4,4'-DDD	0.24	0.24	9.37E-03	1.26E+00	6.18E-04	1.65E-01	1.65E-01
4,4'-DDE	0.81	0.81	9.37E-03	1.26E+00	6.18E-04	5.58E-01	5.58E-01
4,4'-DDT	1.3	1.3	9.37E-03	1.26E+00	6.18E-04	8.96E-01	8.96E-01
Endosulfan I	0.2		1.65E-01	3.00E-01	5.54E-01	4.07E-02	0.00E+00
Endosulfan sulfate	0.11	0.11	2.97E-01	3.00E-01	6.42E-01	2.30E-02	2.30E-02
Endrin	0.12	0.12	4.61E-02	1.80E-01	4.02E-01	1.57E-02	1.57E-02
Endrin aldehyde	0.12	0.12	6.51E-02	1.80E-01	4.39E-01	1.59E-02	1.59E-02
Endrin ketone	0.18	0.18	4.61E-02	1.80E-01	4.02E-01	2.35E-02	2.35E-02
Heptachlor epoxide	0.18	0.18	2.93E-02	1.30E-01	3.55E-05	1.50E-02	1.50E-02
Methoxychlor	0.52	0.52	4.48E-02	3.06E+01	3.99E-01	8.56E+00	8.56E+00
Inorganics							
Antimony	19.3	19.3	2.00E-01	2.20E-01	1.00E-03	2.57E+00	2.57E+00
Arsenic	14.6	14.6	3.60E-02	1.10E-01	2.00E-03	1.06E+00	1.06E+00
Cadmium	12.1	12.1	3.64E-01	9.60E-01	5.50E-04	6.42E+00	6.42E+00
Chromium	60.3	60.3	7.50E-03	1.00E-02	5.50E-03	1.16E+00	1.16E+00

TABLE J-12C
SHORT-TAILED SHREW (*Blarina brevicauda*) EXPOSURE - SEAD-71 SOIL
SEAD-59 and SEAD-71 Phase II RI Report

COPC	Surface Soil (0-2 ft bgs)		Soil-To-Plant	Soil-To-Soil	Small Mammal	Short-Tailed Shrew Surface Soil Exposure (mg/kg/day)	Short-Tailed Shrew Total Soil Exposure (mg/kg/day)
	EPC (mg/kg)	Total Soil (0-4 ft bgs) EPC (mg/kg)	(mg COPC/kg dry tissue)/(mg COPC/kg dry soil)	Invertebrate BAF (mg COPC/kg wet tissue)/(mg COPC/kg dry soil)	BAF (mg COPC/kg wet tissue)/(mg COPC/kg dry soil)		
Cobalt	14.6	14.6	8.10E-02	1.22E-01	2.00E-02	1.18E+00	1.18E+00
Copper	134	134	4.00E-01	4.00E-02	1.00E-02	5.12E+00	5.12E+00
Lead	3470	3470	4.50E-02	3.00E-02	3.00E-04	1.04E+02	1.04E+02
Manganese	1330	1330	2.50E-01	5.40E-02	4.00E-04	5.89E+01	5.89E+01
Mercury	2.7	2.7	3.75E-02	4.00E-02	2.50E-01	1.29E-01	1.29E-01
Nickel	110	110	3.20E-02	2.00E-02	6.00E-03	2.73E+00	2.73E+00
Selenium	1.8	1.8	1.60E-02	2.20E-01	1.50E-02	2.38E-01	2.38E-01
Silver	2.2	2.2	4.00E-01	2.20E-01	3.00E-03	2.96E-01	2.96E-01
Thallium	2.3	2.3	4.00E-03	2.20E-01	4.00E-02	3.07E-01	3.07E-01
Vanadium	29.2	29.2	5.50E-03	2.20E-01	2.50E-03	3.85E+00	3.85E+00
Zinc	3660	3660	1.20E-12	5.60E-01	1.00E-01	1.17E+03	1.17E+03

COPC = Constituent of Potential Concern

EPC = Exposure Point Concentration, the maximum detected concentration

BAF = Bioaccumulation Factor (unitless)

(1) Exposure = $[(C_s * SP * CF * PDF * FR) + (C_s * IDF * BAF * FR) + (C_s * ADF * BAF * FR) + (C_s * Is) * SFF] / BW$

Cs = Soil concentration (mg/kg)

SP = Soil to plant uptake factor from literature

CF = Dry weight to wet weight plant matter conversion factor = 0.2 (unitless)

PDF = Plant dietary fraction (unitless)

FR = Feeding rate (kg/day)

IDF = Invertebrate dietary fraction (unitless)

ADF = Animal dietary fraction (unitless)

Is = Soil dietary (kg/day)

SFF = Site foraging frequency = 1 (unitless)

BW = Body weight (kg)

TABLE J-12D
SHORT-TAILED SHREW (*Blarina brevicauda*) EXPOSURE - SEAD-71 Soil (Fenced Area Excluded)
SEAD-59 and SEAD-71 Phase II RI Report

COPC	Surface Soil (0-2 ft bgs)		Soil-To-Plant (mg COPC/kg dry tissue)/(mg COPC/kg dry soil)	Soil-To-Soil Invertebrate BAF (mg COPC/kg wet tissue)/(mg COPC/kg dry soil)	Small Mammal BAF (mg COPC/kg wet tissue)/(mg COPC/kg dry soil)	Short-Tailed Shrew Surface Soil Exposure (mg/kg/day)	Short-Tailed Shrew Total Soil Exposure (mg/kg/day)
	EPC (mg/kg)	Total Soil (0-4 ft bgs) EPC (mg/kg)					
Semi-Volatile Organic Compounds							
2-Methylnaphthalene	0.77	0.77	1.63E-01	7.00E-02	4.61E-04	4.02E-02	4.02E-02
Acenaphthene	5.8	5.8	2.10E-01	7.00E-02	4.61E-04	3.05E-01	3.05E-01
Acenaphthylene	1.8	1.8	1.72E-01	7.00E-02	4.61E-04	9.42E-02	9.42E-02
Anthracene	11	11	1.04E-01	7.00E-02	4.61E-04	5.70E-01	5.70E-01
Benzo(a)anthracene	37	37	2.02E-02	3.00E-02	1.46E-04	1.10E+00	1.10E+00
Benzo(a)pyrene	22	22	1.10E-02	7.00E-02	4.61E-04	1.13E+00	1.13E+00
Benzo(b)fluoranthene	26	26	1.01E-02	7.00E-02	5.46E-04	1.33E+00	1.33E+00
Benzo(ghi)perylene	10	10	5.70E-03	7.00E-02	4.61E-04	5.12E-01	5.12E-01
Benzo(k)fluoranthene	15	15	1.01E-02	8.00E-02	5.43E-04	8.49E-01	8.49E-01
Carbazole	9.5	9.5	2.74E-01	1.00E+00	6.29E-01	5.54E+00	5.54E+00
Chrysene	36	36	1.87E-02	4.00E-02	1.88E-04	1.27E+00	1.27E+00
Dibenz(a,h)anthracene	9.8	9.8	6.40E-03	7.00E-02	1.21E-03	5.02E-01	5.02E-01
Dibenzofuran	1.4	1.4	1.51E-01	1.00E+00	5.50E-01	8.10E-01	8.10E-01
Fluoranthene	88	88	3.72E-02	7.00E-02	4.61E-04	4.52E+00	4.52E+00
Fluorene	2.8	2.8	1.49E-01	7.00E-02	4.61E-04	1.46E-01	1.46E-01
Indeno(1,2,3-cd)pyrene	12	12	3.90E-03	8.00E-02	2.82E-03	6.80E-01	6.80E-01
Naphthalene	1.1	1.1	4.20E-01	7.00E-02	4.61E-04	5.94E-02	5.94E-02
Phenanthrene	66	66	1.02E-01	7.00E-02	4.61E-04	3.42E+00	3.42E+00
Pyrene	63	63	4.43E-02	7.00E-02	4.61E-04	3.24E+00	3.24E+00
Pesticides							
4,4'-DDD	0.017	0.017	9.37E-03	1.26E+00	6.18E-04	1.17E-02	1.17E-02
4,4'-DDE	0.19	0.19	9.37E-03	1.26E+00	6.18E-04	1.31E-01	1.31E-01
4,4'-DDT	0.12	0.12	9.37E-03	1.26E+00	6.18E-04	8.27E-02	8.27E-02
Endosulfan I	0.2	0.2	1.65E-01	3.00E-01	5.54E-01	4.07E-02	4.07E-02
Endosulfan sulfate	0.0046	0.0046	2.97E-01	3.00E-01	6.42E-01	9.60E-04	9.60E-04
Endrin	0.029	0.029	4.61E-02	1.80E-01	4.02E-01	3.79E-03	3.79E-03
Endrin aldehyde	0.0091	0.0091	6.51E-02	1.80E-01	4.39E-01	1.21E-03	1.21E-03
Endrin ketone	0.017	0.017	4.61E-02	1.80E-01	4.02E-01	2.22E-03	2.22E-03
Heptachlor epoxide	0.0064	0.0064	2.93E-02	1.30E-01	3.55E-05	5.35E-04	5.35E-04
Methoxychlor	0.062	0.062	4.48E-02	3.06E+01	3.99E-01	1.02E+00	1.02E+00
Inorganics							
Antimony	11.5	11.5	2.00E-01	2.20E-01	1.00E-03	1.53E+00	1.53E+00
Arsenic	14.6	14.6	3.60E-02	1.10E-01	2.00E-03	1.06E+00	1.06E+00
Cadmium	0.71	0.71	3.64E-01	9.60E-01	5.50E-04	3.77E-01	3.77E-01
Chromium	37.1	37.1	7.50E-03	1.00E-02	5.50E-03	7.16E-01	7.16E-01

TABLE J-12D
SHORT-TAILED SHREW (*Blarina brevicauda*) EXPOSURE - SEAD-71 Soil (Fenced Area Excluded)
SEAD-59 and SEAD-71 Phase II RI Report

COPC	Surface Soil (0-2 ft bgs)		Soil-To-Plant (mg COPC/kg dry tissue)/(mg COPC/kg dry soil)	Soil-To-Soil Invertebrate BAF (mg COPC/kg wet tissue)/(mg COPC/kg dry soil)	Small Mammal BAF (mg COPC/kg wet tissue)/(mg COPC/kg dry soil)	Short-Tailed Shrew Surface Soil Exposure (mg/kg/day)	Short-Tailed Shrew Total Soil Exposure (mg/kg/day)
	EPC (mg/kg)	Total Soil (0-4 ft bgs) EPC (mg/kg)					
Cobalt	13.9	13.9	8.10E-02	1.22E-01	2.00E-02	1.12E+00	1.12E+00
Copper	102	102	4.00E-01	4.00E-02	1.00E-02	3.90E+00	3.90E+00
Lead	1010	1010	4.50E-02	3.00E-02	3.00E-04	3.03E+01	3.03E+01
Manganese	1330	1330	2.50E-01	5.40E-02	4.00E-04	5.89E+01	5.89E+01
Mercury	1	1	3.75E-02	4.00E-02	2.50E-01	4.79E-02	4.79E-02
Nickel	110	110	3.20E-02	2.00E-02	6.00E-03	2.73E+00	2.73E+00
Selenium	1.8	1.8	1.60E-02	2.20E-01	1.50E-02	2.38E-01	2.38E-01
Silver	1.8	1.8	4.00E-01	2.20E-01	3.00E-03	2.42E-01	2.42E-01
Thallium	2.3	2.3	4.00E-03	2.20E-01	4.00E-02	3.07E-01	3.07E-01
Vanadium	24	24	5.50E-03	2.20E-01	2.50E-03	3.16E+00	3.16E+00
Zinc	1740	1740	1.20E-12	5.60E-01	1.00E-01	5.55E+02	5.55E+02

COPC = Constituent of Potential Concern

EPC = Exposure Point Concentration, the maximum detected concentration

BAF = Bioaccumulation Factor (unitless)

(1) Exposure = $[(C_s * SP * CF * PDF * FR) + (C_s * IDF * BAF * FR) + (C_s * ADF * BAF * FR) + (C_s * Is) * SFF] / BW$

Cs = Soil concentration (mg/kg)

SP = Soil to plant uptake factor from literature

CF = Dry weight to wet weight plant matter conversion factor = 0.2 (unitless)

PDF = Plant dietary fraction (unitless)

FR = Feeding rate (kg/day)

IDF = Invertebrate dietary fraction (unitless)

ADF = Animal dietary fraction (unitless)

Is = Soil dietary (kg/day)

SFF = Site foraging frequency = 1 (unitless)

BW = Body weight (kg)

TABLE J-13A
Red Fox (*Vulpes vulpes*) Exposure - SEAD-59
SEAD-59 and SEAD-71 Phase II RI Report

COPC	Surface Soil (0-2 ft bgs)		Soil-To-Plant (mg COPC/kg dry tissue)/(mg COPC/kg dry soil)	Soil-To-Soil Invertebrate BAF (mg COPC/kg wet tissue)/(mg COPC/kg dry soil)	Small Mammal BAF (mg COPC/kg wet tissue)/(mg COPC/kg dry soil)	Red Fox Surface Soil Exposure (mg/kg/day)	Red Fox Total Soil Exposure (mg/kg/day)
	EPC (mg/kg)	Total Soil (0-4 ft bgs) EPC (mg/kg)					
Semi-Volatile Organic Compounds							
2-Methylnaphthalene		10	1.63E-01	7.00E-02	4.61E-04	0.00E+00	2.97E-02
Acenaphthene	2.68	2.68	2.10E-01	7.00E-02	4.61E-04	8.69E-03	8.69E-03
Acenaphthylene	1.7	1.7	1.72E-01	7.00E-02	4.61E-04	5.14E-03	5.14E-03
Anthracene	4.395	4.395	1.04E-01	7.00E-02	4.61E-04	1.16E-02	1.16E-02
Benzo(a)anthracene	8.9	8.9	2.02E-02	3.00E-02	1.46E-04	1.64E-02	1.64E-02
Benzo(a)pyrene	8.05	8.05	1.10E-02	7.00E-02	4.61E-04	1.69E-02	1.69E-02
Benzo(b)fluoranthene	6.8	6.8	1.01E-02	7.00E-02	5.46E-04	1.44E-02	1.44E-02
Benzo(ghi)perylene	5.2	5.2	5.70E-03	7.00E-02	4.61E-04	1.08E-02	1.08E-02
Benzo(k)fluoranthene	7.35	7.35	1.01E-02	8.00E-02	5.43E-04	1.60E-02	1.60E-02
Carbazole	0.755	0.755	2.74E-01	1.00E+00	6.29E-01	7.04E-02	7.04E-02
Chrysene	8.9	8.9	1.87E-02	4.00E-02	1.88E-04	1.70E-02	1.70E-02
Dibenz(a,h)anthracene	1.665	1.665	6.40E-03	7.00E-02	1.21E-03	3.63E-03	3.63E-03
Dibenzofuran	1.875	1.875	1.51E-01	1.00E+00	5.50E-01	1.54E-01	1.54E-01
Fluoranthene	23.5	23.5	3.72E-02	7.00E-02	4.61E-04	5.30E-02	5.30E-02
Fluorene	2.64	3	1.49E-01	7.00E-02	4.61E-04	7.64E-03	8.68E-03
Indeno(1,2,3-cd)pyrene	4.95	4.95	3.90E-03	8.00E-02	2.82E-03	1.21E-02	1.21E-02
Naphthalene	1.325	1.325	4.20E-01	7.00E-02	4.61E-04	5.88E-03	5.88E-03
Phenanthrene	21.3	21.3	1.02E-01	7.00E-02	4.61E-04	5.59E-02	5.59E-02
Pyrene	19.2	19.2	4.43E-02	7.00E-02	4.61E-04	4.41E-02	4.41E-02
Pesticides							
4,4'-DDD	0.74	0.74	9.37E-03	1.26E+00	6.18E-04	7.48E-03	7.48E-03
4,4'-DDE	2.6	2.6	9.37E-03	1.26E+00	6.18E-04	2.63E-02	2.63E-02
4,4'-DDT	3.7	3.7	9.37E-03	1.26E+00	6.18E-04	3.74E-02	3.74E-02
Metals							
Antimony	424	424	2.00E-01	2.20E-01	1.00E-03	1.81E+00	1.81E+00
Arsenic	32.2	32.2	3.60E-02	1.10E-01	2.00E-03	8.76E-02	8.76E-02
Cadmium	3.2	3.2	3.64E-01	9.60E-01	5.50E-04	3.24E-02	3.24E-02
Chromium	39.3	39.3	7.50E-03	1.00E-02	5.50E-03	9.24E-02	9.24E-02
Cobalt	47.8	47.8	8.10E-02	1.22E-01	2.00E-02	2.60E-01	2.60E-01
Copper	305	305	4.00E-01	4.00E-02	1.00E-02	1.64E+00	1.64E+00
Lead	164	164	4.50E-02	3.00E-02	3.00E-04	3.29E-01	3.29E-01
Manganese	1290	1290	2.50E-01	5.40E-02	4.00E-04	4.33E+00	4.33E+00
Mercury	0.95	0.95	3.75E-02	4.00E-02	2.50E-01	3.34E-02	3.34E-02
Nickel	88.3	88.3	3.20E-02	2.00E-02	6.00E-03	2.32E-01	2.32E-01
Selenium	1.5	1.5	1.60E-02	2.20E-01	1.50E-02	7.61E-03	7.61E-03
Silver	2.9	2.9	4.00E-01	2.20E-01	3.00E-03	1.64E-02	1.64E-02
Thallium	1.8	1.8	4.00E-03	2.20E-01	4.00E-02	1.50E-02	1.50E-02
Vanadium	28.5	28.5	5.50E-03	2.20E-01	2.50E-03	9.55E-02	9.55E-02
Zinc	341	341	1.20E-12	5.60E-01	1.00E-01	6.32E+00	6.32E+00

COPC = Constituent of Potential Concern

EPC = Exposure Point Concentration, the maximum detected concentration

BAF = Bioaccumulation Factor (unitless)

(1) Exposure = $\frac{1}{BW} [(Cs \cdot SP \cdot CF \cdot PDF \cdot FR) + (Cs \cdot IDF \cdot BAF \cdot FR) + (Cs \cdot ADF \cdot BAF \cdot FR) + (Cs \cdot Is) \cdot SFF]$

Cs = Soil concentration (mg/kg)

SP = Soil to plant uptake factor from literature

CF = Dry weight to wet weight plant matter conversion factor = 0.2 (unitless)

PDF = Plant dietary fraction (unitless)

FR = Feeding rate (kg/day)

IDF = Invertebrate dietary fraction (unitless)

ADF = Animal dietary fraction (unitless)

Is = Soil dietary (kg dry/day)

SFF = Site foraging frequency = 1 (unitless)

BW = Body weight (kg)

TABLE J-13B
Red Fox (*Vulpes vulpes*) EXPOSURE - SEAD-59 STOCKPILE SOIL
SEAD-59 AND SEAD-71 PHASE II RI REPORT

COPC	SEAD-59 Stockpile Soil EPC (mg/kg)	Soil-To-Plant (mg COPC/kg dry tissue)/(mg COPC/kg dry soil)	Soil-To-Soil Invertebrate BAF (mg COPC/kg wet tissue)/(mg COPC/kg dry soil)	Small Mammal	
				BAF (mg COPC/kg wet tissue)/(mg COPC/kg dry soil)	Red Fox Stockpile Soil Exposure (mg/kg/day)
Semi-Volatile Organic Compounds					
Acenaphthylene	3.5	1.72E-01	7.00E-02	4.61E-04	1.06E-02
Anthracene	6.6	1.04E-01	7.00E-02	4.61E-04	1.74E-02
Benzo(a)anthracene	14	2.02E-02	3.00E-02	1.46E-04	2.58E-02
Benzo(a)pyrene	16	1.10E-02	7.00E-02	4.61E-04	3.37E-02
Benzo(b)fluoranthene	11	1.01E-02	7.00E-02	5.46E-04	2.32E-02
Benzo(ghi)perylene	8	5.70E-03	7.00E-02	4.61E-04	1.66E-02
Benzo(k)fluoranthene	13	1.01E-02	8.00E-02	5.43E-04	2.83E-02
Carbazole	1.1	2.74E-01	1.00E+00	6.29E-01	1.03E-01
Chrysene	13	1.87E-02	4.00E-02	1.88E-04	2.48E-02
Dibenz(a,h)anthracene	2.9	6.40E-03	7.00E-02	1.21E-03	6.31E-03
Dibenzofuran	1.3	1.51E-01	1.00E+00	5.50E-01	1.07E-01
Fluoranthene	29	3.72E-02	7.00E-02	4.61E-04	6.54E-02
Fluorene	3.1	1.49E-01	7.00E-02	4.61E-04	8.97E-03
Indeno(1,2,3-cd)pyrene	8	3.90E-03	8.00E-02	2.82E-03	1.96E-02
Naphthalene	1.2	4.20E-01	7.00E-02	4.61E-04	5.33E-03
Phenanthrene	17	1.02E-01	7.00E-02	4.61E-04	4.46E-02
Pyrene	22	4.43E-02	7.00E-02	4.61E-04	5.05E-02
Pesticides					
4,4'-DDD	0.45	9.37E-03	1.26E+00	6.18E-04	4.55E-03
4,4'-DDE	0.23	9.37E-03	1.26E+00	6.18E-04	2.33E-03
4,4'-DDT	0.52	9.37E-03	1.26E+00	6.18E-04	5.26E-03
Inorganics					
Antimony	43.9	2.00E-01	2.20E-01	1.00E-03	1.87E-01
Arsenic	7.3	3.60E-02	1.10E-01	2.00E-03	1.99E-02
Cadmium	1.2	3.64E-01	9.60E-01	5.50E-04	1.21E-02
Chromium	35	7.50E-03	1.00E-02	5.50E-03	8.23E-02
Cobalt	13.9	8.10E-02	1.22E-01	2.00E-02	7.57E-02
Copper	51.8	4.00E-01	4.00E-02	1.00E-02	2.79E-01
Lead	1440	4.50E-02	3.00E-02	3.00E-04	2.89E+00
Manganese	1220	2.50E-01	5.40E-02	4.00E-04	4.09E+00
Mercury	0.52	3.75E-02	4.00E-02	2.50E-01	1.83E-02
Nickel	56.6	3.20E-02	2.00E-02	6.00E-03	1.48E-01
Selenium	0.72	1.60E-02	2.20E-01	1.50E-02	3.65E-03
Silver	4.7	4.00E-01	2.20E-01	3.00E-03	2.67E-02
Vanadium	35.4	5.50E-03	2.20E-01	2.50E-03	1.19E-01
Zinc	185	1.20E-12	5.60E-01	1.00E-01	3.43E+00

COPC = Constituent of Potential Concern

EPC = Exposure Point Concentration, the maximum detected concentration

BAF = Bioaccumulation Factor (unitless)

(1) Exposure = $[(C_s * SP * CF * PDF * FR) + (C_s * IDF * BAF * FR) + (C_s * ADF * BAF * FR) + (C_s * I_s) * SFF] / BW$

Cs = Soil concentration (mg/kg)

SP = Soil to plant uptake factor from literature

CF = Dry weight to wet weight plant matter conversion factor = 0.2 (unitless)

PDF = Plant dietary fraction (unitless)

FR = Feeding rate (kg/day)

IDF = Invertebrate dietary fraction (unitless)

ADF = Animal dietary fraction (unitless)

I_s = Soil dietary (kg/day)

SFF = Site foraging frequency = 1 (unitless)

BW = Body weight (kg)

TABLE J-13C
RED FOX (*Vulpes vulpes*) EXPOSURE - SEAD-71 SOIL
SEAD-59 and SEAD-71 Phase II RI Report

COPC	Surface Soil (0-2 ft bgs)		Soil-To-Plant (mg COPC/kg dry tissue)/(mg COPC/kg dry soil)	Soil-To-Soil Invertebrate BAF (mg COPC/kg wet tissue)/(mg COPC/kg dry soil)	Small Mammal BAF (mg COPC/kg wet tissue)/(mg COPC/kg dry soil)	Red Fox Surface Soil Exposure (mg/kg/day)	Red Fox Total Soil Exposure (mg/kg/day)
	EPC (mg/kg)	Total Soil (0-4 ft bgs) EPC (mg/kg)					
Semi-Volatile Organic Compounds							
2-Methylnaphthalene	19	19	1.63E-01	7.00E-02	4.61E-04	5.65E-02	5.65E-02
Acenaphthene	42	42	2.10E-01	7.00E-02	4.61E-04	1.36E-01	1.36E-01
Acenaphthylene	1.8	1.8	1.72E-01	7.00E-02	4.61E-04	5.44E-03	5.44E-03
Anthracene	100	100	1.04E-01	7.00E-02	4.61E-04	2.64E-01	2.64E-01
Benzo(a)anthracene	150	150	2.02E-02	3.00E-02	1.46E-04	2.77E-01	2.77E-01
Benzo(a)pyrene	120	120	1.10E-02	7.00E-02	4.61E-04	2.53E-01	2.53E-01
Benzo(b)fluoranthene	88	88	1.01E-02	7.00E-02	5.46E-04	1.86E-01	1.86E-01
Benzo(ghi)perylene	62	62	5.70E-03	7.00E-02	4.61E-04	1.29E-01	1.29E-01
Benzo(k)fluoranthene	130	130	1.01E-02	8.00E-02	5.43E-04	2.83E-01	2.83E-01
Carbazole	77	77	2.74E-01	1.00E+00	6.29E-01	7.18E+00	7.18E+00
Chrysene	150	150	1.87E-02	4.00E-02	1.88E-04	2.87E-01	2.87E-01
Dibenz(a,h)anthracene	25	25	6.40E-03	7.00E-02	1.21E-03	5.44E-02	5.44E-02
Dibenzofuran	38	38	1.51E-01	1.00E+00	5.50E-01	3.12E+00	3.12E+00
Fluoranthene	440	440	3.72E-02	7.00E-02	4.61E-04	9.92E-01	9.92E-01
Fluorene	62	62	1.49E-01	7.00E-02	4.61E-04	1.79E-01	1.79E-01
Indeno(1,2,3-cd)pyrene	65	65	3.90E-03	8.00E-02	2.82E-03	1.59E-01	1.59E-01
Naphthalene	46	46	4.20E-01	7.00E-02	4.61E-04	2.04E-01	2.04E-01
Phenanthrene	290	290	1.02E-01	7.00E-02	4.61E-04	7.61E-01	7.61E-01
Pyrene	280	280	4.43E-02	7.00E-02	4.61E-04	6.42E-01	6.42E-01
Pesticides							
4,4'-DDD	0.24	0.24	9.37E-03	1.26E+00	6.18E-04	2.43E-03	2.43E-03
4,4'-DDE	0.81	0.81	9.37E-03	1.26E+00	6.18E-04	8.19E-03	8.19E-03
4,4'-DDT	1.3	1.3	9.37E-03	1.26E+00	6.18E-04	1.31E-02	1.31E-02
Endosulfan I	0.2		1.65E-01	3.00E-01	5.54E-01	1.56E-02	0.00E+00
Endosulfan sulfate	0.11	0.11	2.97E-01	3.00E-01	6.42E-01	9.94E-03	9.94E-03
Endrin	0.12	0.12	4.61E-02	1.80E-01	4.02E-01	6.76E-03	6.76E-03
Endrin aldehyde	0.12	0.12	6.51E-02	1.80E-01	4.39E-01	7.36E-03	7.36E-03
Endrin ketone	0.18	0.18	4.61E-02	1.80E-01	4.02E-01	1.01E-02	1.01E-02
Heptachlor epoxide	0.18	0.18	2.93E-02	1.30E-01	3.55E-05	4.60E-04	4.60E-04
Methoxychlor	0.52	0.52	4.48E-02	3.06E+01	3.99E-01	1.35E-01	1.35E-01
Inorganics							
Antimony	19.3	19.3	2.00E-01	2.20E-01	1.00E-03	8.23E-02	8.23E-02
Arsenic	14.6	14.6	3.60E-02	1.10E-01	2.00E-03	3.97E-02	3.97E-02

TABLE J-13C
RED FOX (*Vulpes vulpes*) EXPOSURE - SEAD-71 SOIL
SEAD-59 and SEAD-71 Phase II RI Report

COPC	Surface Soil (0-2 ft bgs)		Soil-To-Plant	Soil-To-Soil	Small Mammal	Red Fox Surface Soil Exposure (mg/kg/day)	Red Fox Total Soil Exposure (mg/kg/day)
	EPC (mg/kg)	Total Soil (0-4 ft bgs) EPC (mg/kg)	(mg COPC/kg dry tissue)/(mg COPC/kg dry soil)	Invertebrate BAF (mg COPC/kg wet tissue)/(mg COPC/kg dry soil)	BAF (mg COPC/kg wet tissue)/(mg COPC/kg dry soil)		
Cadmium	12.1	12.1	3.64E-01	9.60E-01	5.50E-04	1.22E-01	1.22E-01
Chromium	60.3	60.3	7.50E-03	1.00E-02	5.50E-03	1.42E-01	1.42E-01
Cobalt	14.6	14.6	8.10E-02	1.22E-01	2.00E-02	7.95E-02	7.95E-02
Copper	134	134	4.00E-01	4.00E-02	1.00E-02	7.22E-01	7.22E-01
Lead	3470	3470	4.50E-02	3.00E-02	3.00E-04	6.97E+00	6.97E+00
Manganese	1330	1330	2.50E-01	5.40E-02	4.00E-04	4.46E+00	4.46E+00
Mercury	2.7	2.7	3.75E-02	4.00E-02	2.50E-01	9.50E-02	9.50E-02
Nickel	110	110	3.20E-02	2.00E-02	6.00E-03	2.89E-01	2.89E-01
Selenium	1.8	1.8	1.60E-02	2.20E-01	1.50E-02	9.13E-03	9.13E-03
Silver	2.2	2.2	4.00E-01	2.20E-01	3.00E-03	1.25E-02	1.25E-02
Thallium	2.3	2.3	4.00E-03	2.20E-01	4.00E-02	1.91E-02	1.91E-02
Vanadium	29.2	29.2	5.50E-03	2.20E-01	2.50E-03	9.79E-02	9.79E-02
Zinc	3660	3660	1.20E-12	5.60E-01	1.00E-01	6.79E+01	6.79E+01

COPC = Constituent of Potential Concern

EPC = Exposure Point Concentration, the maximum detected concentration

BAF = Bioaccumulation Factor (unitless)

(1) Exposure = $[(C_s * SP * CF * PDF * FR) + (C_s * IDF * BAF * FR) + (C_s * ADF * BAF * FR) + (C_s * I_s)] * SFF / BW$

C_s = Soil concentration (mg/kg)

SP = Soil to plant uptake factor from literature

CF = Dry weight to wet weight plant matter conversion factor = 0.2 (unitless)

PDF = Plant dietary fraction (unitless)

FR = Feeding rate (kg/day)

IDF = Invertebrate dietary fraction (unitless)

ADF = Animal dietary fraction (unitless)

I_s = Soil dietary (kg/day)

SFF = Site foraging frequency = 1 (unitless)

BW = Body weight (kg)

TABLE J-13D
RED FOX (*Vulpes vulpes*) EXPOSURE - SEAD-71 Soil (Fenced Area Excluded)
SEAD-59 and SEAD-71 Phase II RI Report

COPC	Surface Soil (0-2 ft bgs)		Soil-To-Plant (mg COPC/kg dry tissue)/(mg COPC/kg dry soil)	Soil-To-Soil Invertebrate BAF (mg COPC/kg wet tissue)/(mg COPC/kg dry soil)	Small Mammal BAF (mg COPC/kg wet tissue)/(mg COPC/kg dry soil)	Red Fox Surface Soil Exposure (mg/kg/day)	Red Fox Total Soil Exposure (mg/kg/day)
	EPC (mg/kg)	Total Soil (0-4 ft bgs) EPC (mg/kg)					
Semi-Volatile Organic Compounds							
2-Methylnaphthalene	0.77	0.77	1.63E-01	7.00E-02	4.61E-04	2.29E-03	2.29E-03
Acenaphthene	5.8	5.8	2.10E-01	7.00E-02	4.61E-04	1.88E-02	1.88E-02
Acenaphthylene	1.8	1.8	1.72E-01	7.00E-02	4.61E-04	5.44E-03	5.44E-03
Anthracene	11	11	1.04E-01	7.00E-02	4.61E-04	2.90E-02	2.90E-02
Benzo(a)anthracene	37	37	2.02E-02	3.00E-02	1.46E-04	6.83E-02	6.83E-02
Benzo(a)pyrene	22	22	1.10E-02	7.00E-02	4.61E-04	4.63E-02	4.63E-02
Benzo(b)fluoranthene	26	26	1.01E-02	7.00E-02	5.46E-04	5.49E-02	5.49E-02
Benzo(ghi)perylene	10	10	5.70E-03	7.00E-02	4.61E-04	2.07E-02	2.07E-02
Benzo(k)fluoranthene	15	15	1.01E-02	8.00E-02	5.43E-04	3.27E-02	3.27E-02
Carbazole	9.5	9.5	2.74E-01	1.00E+00	6.29E-01	8.86E-01	8.86E-01
Chrysene	36	36	1.87E-02	4.00E-02	1.88E-04	6.88E-02	6.88E-02
Dibenz(a,h)anthracene	9.8	9.8	6.40E-03	7.00E-02	1.21E-03	2.13E-02	2.13E-02
Dibenzofuran	1.4	1.4	1.51E-01	1.00E+00	5.50E-01	1.15E-01	1.15E-01
Fluoranthene	88	88	3.72E-02	7.00E-02	4.61E-04	1.98E-01	1.98E-01
Fluorene	2.8	2.8	1.49E-01	7.00E-02	4.61E-04	8.10E-03	8.10E-03
Indeno(1,2,3-cd)pyrene	12	12	3.90E-03	8.00E-02	2.82E-03	2.93E-02	2.93E-02
Naphthalene	1.1	1.1	4.20E-01	7.00E-02	4.61E-04	4.88E-03	4.88E-03
Phenanthrene	66	66	1.02E-01	7.00E-02	4.61E-04	1.73E-01	1.73E-01
Pyrene	63	63	4.43E-02	7.00E-02	4.61E-04	1.45E-01	1.45E-01
Pesticides							
4,4'-DDD	0.017	0.017	9.37E-03	1.26E+00	6.18E-04	1.72E-04	1.72E-04
4,4'-DDE	0.19	0.19	9.37E-03	1.26E+00	6.18E-04	1.92E-03	1.92E-03
4,4'-DDT	0.12	0.12	9.37E-03	1.26E+00	6.18E-04	1.21E-03	1.21E-03
Endosulfan I	0.2	0.2	1.65E-01	3.00E-01	5.54E-01	1.56E-02	1.56E-02
Endosulfan sulfate	0.0046	0.0046	2.97E-01	3.00E-01	6.42E-01	4.16E-04	4.16E-04
Endrin	0.029	0.029	4.61E-02	1.80E-01	4.02E-01	1.63E-03	1.63E-03
Endrin aldehyde	0.0091	0.0091	6.51E-02	1.80E-01	4.39E-01	5.58E-04	5.58E-04
Endrin ketone	0.017	0.017	4.61E-02	1.80E-01	4.02E-01	9.58E-04	9.58E-04
Heptachlor epoxide	0.0064	0.0064	2.93E-02	1.30E-01	3.55E-05	1.64E-05	1.64E-05
Methoxychlor	0.062	0.062	4.48E-02	3.06E+01	3.99E-01	1.62E-02	1.62E-02
Inorganics							
Antimony	11.5	11.5	2.00E-01	2.20E-01	1.00E-03	4.90E-02	4.90E-02
Arsenic	14.6	14.6	3.60E-02	1.10E-01	2.00E-03	3.97E-02	3.97E-02
Cadmium	0.71	0.71	3.64E-01	9.60E-01	5.50E-04	7.18E-03	7.18E-03
Chromium	37.1	37.1	7.50E-03	1.00E-02	5.50E-03	8.72E-02	8.72E-02

TABLE J-13D
RED FOX (*Vulpes vulpes*) EXPOSURE - SEAD-71 Soil (Fenced Area Excluded)
SEAD-59 and SEAD-71 Phase II RI Report

COPC	Surface Soil (0-2 ft bgs)		Soil-To-Plant (mg COPC/kg dry tissue)/(mg COPC/kg dry soil)	Soil-To-Soil Invertebrate BAF (mg COPC/kg wet tissue)/(mg COPC/kg dry soil)	Small Mammal BAF (mg COPC/kg wet tissue)/(mg COPC/kg dry soil)	Red Fox Surface Soil Exposure (mg/kg/day)	Red Fox Total Soil Exposure (mg/kg/day)
	EPC (mg/kg)	Total Soil (0-4 ft bgs) EPC (mg/kg)					
Cobalt	13.9	13.9	8.10E-02	1.22E-01	2.00E-02	7.57E-02	7.57E-02
Copper	102	102	4.00E-01	4.00E-02	1.00E-02	5.50E-01	5.50E-01
Lead	1010	1010	4.50E-02	3.00E-02	3.00E-04	2.03E+00	2.03E+00
Manganese	1330	1330	2.50E-01	5.40E-02	4.00E-04	4.46E+00	4.46E+00
Mercury	1	1	3.75E-02	4.00E-02	2.50E-01	3.52E-02	3.52E-02
Nickel	110	110	3.20E-02	2.00E-02	6.00E-03	2.89E-01	2.89E-01
Selenium	1.8	1.8	1.60E-02	2.20E-01	1.50E-02	9.13E-03	9.13E-03
Silver	1.8	1.8	4.00E-01	2.20E-01	3.00E-03	1.02E-02	1.02E-02
Thallium	2.3	2.3	4.00E-03	2.20E-01	4.00E-02	1.91E-02	1.91E-02
Vanadium	24	24	5.50E-03	2.20E-01	2.50E-03	8.04E-02	8.04E-02
Zinc	1740	1740	1.20E-12	5.60E-01	1.00E-01	3.23E+01	3.23E+01

COPC = Constituent of Potential Concern

EPC = Exposure Point Concentration, the maximum detected concentration

BAF = Bioaccumulation Factor (unitless)

(1) Exposure = $[(C_s * SP * CF * PDF * FR) + (C_s * IDF * BAF * FR) + (C_s * ADF * BAF * FR) + (C_s * I_s) * SFF] / BW$

Cs = Soil concentration (mg/kg)

SP = Soil to plant uptake factor from literature

CF = Dry weight to wet weight plant matter conversion factor = 0.2 (unitless)

PDF = Plant dietary fraction (unitless)

FR = Feeding rate (kg/day)

IDF = Invertebrate dietary fraction (unitless)

ADF = Animal dietary fraction (unitless)

Is = Soil dietary (kg/day)

SFF = Site foraging frequency = 1 (unitless)

BW = Body weight (kg)

TABLE J-14A
RECEPTOR NOAEL HAZARD QUOTIENTS - SEAD-59
SEAD-59 and SEAD-71 Phase II RI Report

COPC	Retained as Preliminary COC ⁽¹⁾ Y/N	Deer Mouse Surface Soil NOAEL HQ	Deer Mouse Total Soil NOAEL HQ	American Robin Surface Soil NOAEL HQ	American Robin Total Soil NOAEL HQ	Short-Tailed Shrew Surface Soil NOAEL HQ	Short-Tailed Shrew Total Soil NOAEL HQ	Red Fox Surface Soil NOAEL HQ	Red Fox Total Soil NOAEL HQ
Semi-Volatile Organic Compounds									
2-Methylnaphthalene	N	0.E+00	5.E-02	0.E+00	2.E-02	0.E+00	7.E-02	0.E+00	6.E-03
Acenaphthene	N	9.E-02	9.E-02	4.E-03	4.E-03	1.E-01	1.E-01	1.E-02	1.E-02
Acenaphthylene	N	6.E-02	6.E-02	3.E-03	3.E-03	9.E-02	9.E-02	7.E-03	7.E-03
Anthracene	N	1.E-01	1.E-01	7.E-03	7.E-03	2.E-01	2.E-01	2.E-02	2.E-02
Benzo(a)anthracene	N	1.E-01	1.E-01	8.E-03	8.E-03	3.E-01	3.E-01	2.E-02	2.E-02
Benzo(a)pyrene	N	2.E-01	2.E-01	1.E-02	1.E-02	4.E-01	4.E-01	2.E-02	2.E-02
Benzo(b)fluoranthene	N	2.E-01	2.E-01	1.E-02	1.E-02	3.E-01	3.E-01	2.E-02	2.E-02
Benzo(ghi)perylene	N	1.E-01	1.E-01	8.E-03	8.E-03	3.E-01	3.E-01	1.E-02	1.E-02
Benzo(k)fluoranthene	N	2.E-01	2.E-01	1.E-02	1.E-02	4.E-01	4.E-01	2.E-02	2.E-02
Carbazole	N	5.E-02	5.E-02	1.E-02	1.E-02	7.E-02	7.E-02	2.E-02	2.E-02
Chrysene	N	1.E-01	1.E-01	1.E-02	1.E-02	3.E-01	3.E-01	2.E-02	2.E-02
Dibenz(a,h)anthracene	N	4.E-02	4.E-02	3.E-03	3.E-03	8.E-02	8.E-02	5.E-03	5.E-03
Dibenzofuran	N	7.E-01	7.E-01	3.E-02	3.E-02	1.E+00	1.E+00	2.E-01	2.E-01
Fluoranthene	N	5.E-02	5.E-02	4.E-02	4.E-02	9.E-02	9.E-02	6.E-03	6.E-03
Fluorene	N	7.E-03	8.E-03	4.E-03	5.E-03	1.E-02	1.E-02	8.E-04	9.E-04
Indeno(1,2,3-cd)pyrene	N	1.E-01	1.E-01	8.E-03	8.E-03	3.E-01	3.E-01	2.E-02	2.E-02
Naphthalene	N	8.E-03	8.E-03	2.E-03	2.E-03	1.E-02	1.E-02	1.E-03	1.E-03
Phenanthrene	Y	6.E-01	6.E-01	3.E-02	3.E-02	1.E+00	1.E+00	7.E-02	7.E-02
Pyrene	N	5.E-01	5.E-01	3.E-02	3.E-02	9.E-01	9.E-01	6.E-02	6.E-02
Pesticides									
4,4'-DDD	N	2.E-03	2.E-03	5.E-01	5.E-01	3.E-03	3.E-03	7.E-05	7.E-05
4,4'-DDE	Y	1.E+00	1.E+00	2.E+00	2.E+00	1.E+00	1.E+00	3.E-02	3.E-02
4,4'-DDT	Y	2.E+00	2.E+00	7.E+02	7.E+02	3.E+00	3.E+00	5.E-02	5.E-02
Metals									
Antimony	Y	3.E+02	3.E+02	NA	NA	4.E+02	4.E+02	2.E+01	2.E+01
Arsenic	Y	1.E+01	1.E+01	8.E-01	8.E-01	2.E+01	2.E+01	9.E-01	9.E-01
Cadmium	Y	1.E+00	1.E+00	9.E-01	9.E-01	1.E+00	1.E+00	4.E-02	4.E-02
Chromium	N	6.E-05	6.E-05	7.E-01	7.E-01	2.E-04	2.E-04	4.E-05	4.E-05
Cobalt	Y	1.E+00	1.E+00	3.E-02	3.E-02	2.E+00	2.E+00	2.E-01	2.E-01
Copper	N	7.E-01	7.E-01	2.E-01	2.E-01	8.E-01	8.E-01	2.E-01	2.E-01
Lead	Y	2.E-01	2.E-01	1.E+00	1.E+00	5.E-01	5.E-01	5.E-02	5.E-02
Manganese	N	4.E-01	4.E-01	5.E-01	5.E-01	5.E-01	5.E-01	6.E-02	6.E-02
Mercury	N	1.E-02	1.E-02	7.E-02	7.E-02	4.E-02	4.E-02	4.E-02	4.E-02
Nickel	N	2.E-02	2.E-02	3.E-02	3.E-02	5.E-02	5.E-02	7.E-03	7.E-03

TABLE J-14A
RECEPTOR NOAEL HAZARD QUOTIENTS - SEAD-59
SEAD-59 and SEAD-71 Phase II RI Report

COPC	Retained as Preliminary COC ⁽¹⁾	Deer Mouse Surface Soil	Deer Mouse Total Soil	American Robin Surface Soil	American Robin Total Soil	Short-Tailed Shrew Surface Soil	Short-Tailed Shrew Total Soil	Red Fox Surface Soil	Red Fox Total Soil
	Y/N	NOAEL HQ	NOAEL HQ	NOAEL HQ	NOAEL HQ	NOAEL HQ	NOAEL HQ	NOAEL HQ	NOAEL HQ
Selenium	N	5.E-01	5.E-01	3.E-01	3.E-01	8.E-01	8.E-01	4.E-02	4.E-02
Silver	Y	7.E-01	7.E-01	2.E-03	2.E-03	1.E+00	1.E+00	6.E-02	6.E-02
Thallium	Y	9.E-01	9.E-01	5.E-01	5.E-01	2.E+00	2.E+00	1.E-01	1.E-01
Vanadium	Y	9.E+00	9.E+00	3.E-01	3.E-01	1.E+01	1.E+01	5.E-01	5.E-01
Zinc	N	4.E-01	4.E-01	6.E-01	6.E-01	6.E-01	6.E-01	5.E-02	5.E-02

NOAEL = No Observed Adverse Effect Level

COPC = Constituent of Potential Concern

SEV = Screening Ecotoxicity Value

HQ = Hazard Quotient (Exposure/SEV)

COC = Constituent of concern

(1) COPC considered a preliminary COC if NOAEL HQ > 1 or HQ=1 for any receptor

(2) HQs based on the maximum detected concentrations

Note: HQ>1 and HQ=1 are in bold.

TABLE J-14B
RECEPTOR NOAEL HAZARD QUOTIENTS - SEAD-59 STOCKPILE SOIL
SEAD-59 AND SEAD-71 PHASE II RI REPORT

COPC	Retained as Preliminary COC ⁽¹⁾ Y/N	Deer Mouse Surface Soil NOAEL HQ	American Robin Surface Soil NOAEL HQ	Short-Tailed Shrew Surface Soil NOAEL HQ	Red Fox Surface Soil NOAEL HQ
Semi-Volatile Organic Compounds					
Acenaphthylene	N	1.E-01	5.E-03	2.E-01	1.E-02
Anthracene	N	2.E-01	1.E-02	3.E-01	2.E-02
Benzo(a)anthracene	N	2.E-01	1.E-02	4.E-01	3.E-02
Benzo(a)pyrene	N	4.E-01	2.E-02	8.E-01	5.E-02
Benzo(b)fluoranthene	N	3.E-01	2.E-02	5.E-01	3.E-02
Benzo(ghi)perylene	N	2.E-01	1.E-02	4.E-01	2.E-02
Benzo(k)fluoranthene	N	4.E-01	2.E-02	7.E-01	4.E-02
Carbazole	N	7.E-02	2.E-02	1.E-01	2.E-02
Chrysene	N	2.E-01	1.E-02	4.E-01	3.E-02
Dibenz(a,h)anthracene	N	8.E-02	4.E-03	1.E-01	8.E-03
Dibenzofuran	N	5.E-01	2.E-02	7.E-01	1.E-01
Fluoranthene	N	6.E-02	4.E-02	1.E-01	7.E-03
Fluorene	N	8.E-03	5.E-03	1.E-02	1.E-03
Indeno(1,2,3-cd)pyrene	N	2.E-01	1.E-02	4.E-01	3.E-02
Naphthalene	N	7.E-03	2.E-03	9.E-03	1.E-03
Phenanthrene	N	5.E-01	3.E-02	8.E-01	6.E-02
Pyrene	Y	6.E-01	3.E-02	1.E+00	7.E-02
Pesticides					
4,4'-DDD	N	1.E-03	3.E-01	2.E-03	4.E-05
4,4'-DDE	N	9.E-02	1.E-01	1.E-01	3.E-03
4,4'-DDT	N	2.E-01	1.E+02	4.E-01	8.E-03
Inorganics					
Antimony	Y	3.E+01	NA	4.E+01	2.E+00
Arsenic	Y	2.E+00	2.E-01	4.E+00	2.E-01
Cadmium	N	4.E-01	3.E-01	5.E-01	1.E-02
Chromium	N	6.E-05	6.E-01	2.E-04	3.E-05
Cobalt	N	4.E-01	9.E-03	6.E-01	5.E-02
Copper	N	1.E-01	4.E-02	1.E-01	3.E-02
Lead	Y	2.E+00	1.E+01	4.E+00	4.E-01
Manganese	N	4.E-01	5.E-01	5.E-01	5.E-02
Mercury	N	7.E-03	4.E-02	2.E-02	2.E-02
Nickel	N	1.E-02	2.E-02	3.E-02	4.E-03
Selenium	N	2.E-01	2.E-01	4.E-01	2.E-02
Silver	Y	1.E+00	3.E-03	2.E+00	1.E-01
Vanadium	Y	1.E+01	3.E-01	2.E+01	7.E-01
Zinc	N	2.E-01	3.E-01	3.E-01	2.E-02

NOAEL = No Observed Adverse Effect Level

COPC = Constituent of Potential Concern

SEV = Screening Ecotoxicity Value

HQ = Hazard Quotient (Exposure/SEV)

COC = Constituent of concern

(1) COPC considered a preliminary COC if NOAEL HQ > 1 or HQ=1 for any receptor

(2) HQs based on the maximum detected concentrations

Note: HQ>1 and HQ=1 are in bold.

TABLE J-14C
RECEPTOR NOAEL HAZARD QUOTIENTS - SEAD-71
SEAD-59 and SEAD-71 Phase II RI Report

COPC	Deer Mouse	Deer Mouse	American	American	Short-Tailed	Short-Tailed	Red Fox	Red Fox
	Surface Soil	Total Soil	Robin	Robin	Shrew	Shrew	Surface Soil	Total Soil
	NOAEL HQ	NOAEL HQ	Surface Soil	Total Soil	Surface Soil	Total Soil	NOAEL HQ	NOAEL HQ
Semi-Volatile Organic Compounds								
2-Methylnaphthalene	9.E-02	9.E-02	3.E-02	3.E-02	1.E-01	1.E-01	1.E-02	1.E-02
Acenaphthene	1.E+00	1.E+00	7.E-02	7.E-02	2.E+00	2.E+00	2.E-01	2.E-01
Acenaphthylene	6.E-02	6.E-02	3.E-03	3.E-03	9.E-02	9.E-02	7.E-03	7.E-03
Anthracene	3.E+00	3.E+00	2.E-01	2.E-01	5.E+00	5.E+00	4.E-01	4.E-01
Benzo(a)anthracene	2.E+00	2.E+00	1.E-01	1.E-01	4.E+00	4.E+00	4.E-01	4.E-01
Benzo(a)pyrene	3.E+00	3.E+00	2.E-01	2.E-01	6.E+00	6.E+00	3.E-01	3.E-01
Benzo(b)fluoranthene	2.E+00	2.E+00	1.E-01	1.E-01	4.E+00	4.E+00	2.E-01	2.E-01
Benzo(ghi)perylene	2.E+00	2.E+00	9.E-02	9.E-02	3.E+00	3.E+00	2.E-01	2.E-01
Benzo(k)fluoranthene	4.E+00	4.E+00	2.E-01	2.E-01	7.E+00	7.E+00	4.E-01	4.E-01
Carbazole	5.E+00	5.E+00	1.E+00	1.E+00	7.E+00	7.E+00	2.E+00	2.E+00
Chrysene	2.E+00	2.E+00	2.E-01	2.E-01	5.E+00	5.E+00	4.E-01	4.E-01
Dibenz(a,h)anthracene	7.E-01	7.E-01	4.E-02	4.E-02	1.E+00	1.E+00	7.E-02	7.E-02
Dibenzofuran	1.E+01	1.E+01	6.E-01	6.E-01	2.E+01	2.E+01	4.E+00	4.E+00
Fluoranthene	1.E+00	1.E+00	7.E-01	7.E-01	2.E+00	2.E+00	1.E-01	1.E-01
Fluorene	2.E-01	2.E-01	1.E-01	1.E-01	2.E-01	2.E-01	2.E-02	2.E-02
Indeno(1,2,3-cd)pyrene	2.E+00	2.E+00	1.E-01	1.E-01	4.E+00	4.E+00	2.E-01	2.E-01
Naphthalene	3.E-01	3.E-01	7.E-02	7.E-02	3.E-01	3.E-01	4.E-02	4.E-02
Phenanthrene	9.E+00	9.E+00	4.E-01	4.E-01	1.E+01	1.E+01	1.E+00	1.E+00
Pyrene	8.E+00	8.E+00	4.E-01	4.E-01	1.E+01	1.E+01	9.E-01	9.E-01
Pesticides								
4,4'-DDD	7.E-04	7.E-04	2.E-01	2.E-01	1.E-03	1.E-03	2.E-05	2.E-05
4,4'-DDE	3.E-01	3.E-01	5.E-01	5.E-01	5.E-01	5.E-01	9.E-03	9.E-03
4,4'-DDT	6.E-01	6.E-01	2.E+02	2.E+02	9.E-01	9.E-01	2.E-02	2.E-02
Endosulfan I	1.E-01	0.E+00	3.E-03	0.E+00	2.E-01	0.E+00	1.E-01	0.E+00
Endosulfan sulfate	8.E-02	8.E-02	2.E-03	2.E-03	1.E-01	1.E-01	8.E-02	8.E-02
Endrin	9.E-02	9.E-02	4.E-02	4.E-02	2.E-01	2.E-01	1.E-01	1.E-01
Endrin aldehyde	9.E-02	9.E-02	4.E-02	4.E-02	2.E-01	2.E-01	1.E-01	1.E-01
Endrin ketone	1.E-01	1.E-01	5.E-02	5.E-02	2.E-01	2.E-01	1.E-01	1.E-01
Heptachlor epoxide	7.E-02	7.E-02	2.E-01	2.E-01	1.E-01	1.E-01	5.E-03	5.E-03
Methoxychlor	1.E+00	1.E+00	3.E-01	3.E-01	2.E+00	2.E+00	4.E-02	4.E-02
Inorganics								
Antimony	1.E+01	1.E+01	NA	NA	2.E+01	2.E+01	9.E-01	9.E-01
Arsenic	5.E+00	5.E+00	4.E-01	4.E-01	8.E+00	8.E+00	4.E-01	4.E-01

TABLE J-14C
RECEPTOR NOAEL HAZARD QUOTIENTS - SEAD-71
SEAD-59 and SEAD-71 Phase II RI Report

COPC	Deer Mouse	Deer Mouse	American	American	Short-Tailed	Short-Tailed	Red Fox	Red Fox
	Surface Soil	Total Soil	Robin	Robin	Shrew	Shrew	Surface Soil	Total Soil
	NOAEL HQ	NOAEL HQ	Surface Soil	Total Soil	Surface Soil	Total Soil	NOAEL HQ	NOAEL HQ
Cadmium	4.E+00	4.E+00	3.E+00	3.E+00	5.E+00	5.E+00	1.E-01	1.E-01
Chromium	1.E-04	1.E-04	1.E+00	1.E+00	4.E-04	4.E-04	6.E-05	6.E-05
Cobalt	4.E-01	4.E-01	1.E-02	1.E-02	6.E-01	6.E-01	6.E-02	6.E-02
Copper	3.E-01	3.E-01	9.E-02	9.E-02	3.E-01	3.E-01	7.E-02	7.E-02
Lead	5.E+00	5.E+00	2.E+01	2.E+01	1.E+01	1.E+01	1.E+00	1.E+00
Manganese	4.E-01	4.E-01	5.E-01	5.E-01	6.E-01	6.E-01	6.E-02	6.E-02
Mercury	4.E-02	4.E-02	2.E-01	2.E-01	1.E-01	1.E-01	1.E-01	1.E-01
Nickel	2.E-02	2.E-02	3.E-02	3.E-02	6.E-02	6.E-02	8.E-03	8.E-03
Selenium	6.E-01	6.E-01	4.E-01	4.E-01	1.E+00	1.E+00	5.E-02	5.E-02
Silver	6.E-01	6.E-01	1.E-03	1.E-03	8.E-01	8.E-01	4.E-02	4.E-02
Thallium	1.E+00	1.E+00	7.E-01	7.E-01	2.E+00	2.E+00	2.E-01	2.E-01
Vanadium	9.E+00	9.E+00	3.E-01	3.E-01	2.E+01	2.E+01	5.E-01	5.E-01
Zinc	4.E+00	4.E+00	7.E+00	7.E+00	6.E+00	6.E+00	5.E-01	5.E-01

NOAEL = No Observed Adverse Effect Level
COPC = Constituent of Potential Concern
SEV = Screening Ecotoxicity Value
HQ = Hazard Quotient (Exposure/SEV)
COC = Constituent of concern
Note: HQ>1 and HQ=1 are in bold.
HQs based on the maximum detected concentrations.

TABLE J-14D
RECEPTOR NOAEL HAZARD QUOTIENTS - SEAD-71 (FENCED AREA EXCLUDED)
SEAD-59 and SEAD-71 Phase II RI Report

COPC	Retained as Preliminary COC ⁽¹⁾ Y/N	Deer Mouse Surface Soil Maximum NOAEL HQ	Deer Mouse Total Soil Maximum NOAEL HQ	American Robin Surface Soil Maximum NOAEL HQ	American Robin Total Soil Maximum NOAEL HQ	Short-Tailed Shrew Surface Soil Maximum NOAEL HQ	Short-Tailed Shrew Total Soil Maximum NOAEL HQ	Red Fox Surface Soil Maximum NOAEL HQ	Red Fox Total Soil Maximum NOAEL HQ
Semi-Volatile Organic Compounds									
2-Methylnaphthalene	N	4E-03	4E-03	1E-03	1E-03	5E-03	5E-03	4E-04	4E-04
Acenaphthene	N	2E-01	2E-01	9E-03	9E-03	3E-01	3E-01	3E-02	3E-02
Acenaphthylene	N	6E-02	6E-02	3E-03	3E-03	9E-02	9E-02	7E-03	7E-03
Anthracene	N	3E-01	3E-01	2E-02	2E-02	5E-01	5E-01	4E-02	4E-02
Benzo(a)anthracene	Y	5E-01	5E-01	3E-02	3E-02	1E+00	1E+00	9E-02	9E-02
Benzo(a)pyrene	Y	6E-01	6E-01	3E-02	3E-02	1E+00	1E+00	6E-02	6E-02
Benzo(b)fluoranthene	Y	7E-01	7E-01	4E-02	4E-02	1E+00	1E+00	7E-02	7E-02
Benzo(ghi)perylene	N	3E-01	3E-01	2E-02	2E-02	5E-01	5E-01	3E-02	3E-02
Benzo(k)fluoranthene	N	4E-01	4E-01	2E-02	2E-02	8E-01	8E-01	4E-02	4E-02
Carbazole	N	6E-01	6E-01	1E-01	1E-01	9E-01	9E-01	2E-01	2E-01
Chrysene	Y	6E-01	6E-01	4E-02	4E-02	1E+00	1E+00	9E-02	9E-02
Dibenz(a,h)anthracene	N	3E-01	3E-01	1E-02	1E-02	5E-01	5E-01	3E-02	3E-02
Dibenzofuran	N	5E-01	5E-01	2E-02	2E-02	8E-01	8E-01	2E-01	2E-01
Fluoranthene	N	2E-01	2E-01	1E-01	1E-01	3E-01	3E-01	2E-02	2E-02
Fluorene	N	7E-03	7E-03	4E-03	4E-03	1E-02	1E-02	9E-04	9E-04
Indeno(1,2,3-cd)pyrene	N	4E-01	4E-01	2E-02	2E-02	7E-01	7E-01	4E-02	4E-02
Naphthalene	N	7E-03	7E-03	2E-03	2E-03	8E-03	8E-03	9E-04	9E-04
Phenanthrene	Y	2E+00	2E+00	1E-01	1E-01	3E+00	3E+00	2E-01	2E-01
Pyrene	Y	2E+00	2E+00	1E-01	1E-01	3E+00	3E+00	2E-01	2E-01
Pesticides									
4,4'-DDD	N	5E-05	5E-05	1E-02	1E-02	8E-05	8E-05	2E-06	2E-06
4,4'-DDE	N	7E-02	7E-02	1E-01	1E-01	1E-01	1E-01	2E-03	2E-03
4,4'-DDT	Y	6E-02	6E-02	2E+01	2E+01	9E-02	9E-02	2E-03	2E-03
Endosulfan I	N	1E-01	1E-01	3E-03	3E-03	2E-01	2E-01	1E-01	1E-01
Endosulfan sulfate	N	3E-03	3E-03	6E-05	6E-05	5E-03	5E-03	3E-03	3E-03
Endrin	N	2E-02	2E-02	9E-03	9E-03	4E-02	4E-02	2E-02	2E-02
Endrin aldehyde	N	7E-03	7E-03	3E-03	3E-03	1E-02	1E-02	8E-03	8E-03
Endrin ketone	N	1E-02	1E-02	5E-03	5E-03	2E-02	2E-02	1E-02	1E-02
Heptachlor epoxide	N	2E-03	2E-03	7E-03	7E-03	4E-03	4E-03	2E-04	2E-04
Methoxychlor	N	1E-01	1E-01	3E-02	3E-02	2E-01	2E-01	5E-03	5E-03
Inorganics									
Antimony	Y	8E+00	8E+00	NA	NA	1E+01	1E+01	5E-01	5E-01

TABLE J-14D
RECEPTOR NOAEL HAZARD QUOTIENTS - SEAD-71 (FENCED AREA EXCLUDED)
SEAD-59 and SEAD-71 Phase II RI Report

COPC	Retained as Preliminary COC ⁽¹⁾ Y/N	Deer Mouse Surface Soil Maximum NOAEL HQ	Deer Mouse Total Soil Maximum NOAEL HQ	American Robin Surface Soil Maximum NOAEL HQ	American Robin Total Soil Maximum NOAEL HQ	Short-Tailed Shrew Surface Soil Maximum NOAEL HQ	Short-Tailed Shrew Total Soil Maximum NOAEL HQ	Red Fox Surface Soil Maximum NOAEL HQ	Red Fox Total Soil Maximum NOAEL HQ
Arsenic	Y	5E+00	5E+00	4E-01	4E-01	8E+00	8E+00	4E-01	4E-01
Cadmium	N	2E-01	2E-01	2E-01	2E-01	3E-01	3E-01	8E-03	8E-03
Chromium	N	6E-05	6E-05	7E-01	7E-01	2E-04	2E-04	4E-05	4E-05
Cobalt	N	4E-01	4E-01	9E-03	9E-03	6E-01	6E-01	5E-02	5E-02
Copper	N	2E-01	2E-01	7E-02	7E-02	3E-01	3E-01	5E-02	5E-02
Lead	Y	2E+00	2E+00	7E+00	7E+00	3E+00	3E+00	3E-01	3E-01
Manganese	N	4E-01	4E-01	5E-01	5E-01	6E-01	6E-01	6E-02	6E-02
Mercury	N	1E-02	1E-02	7E-02	7E-02	4E-02	4E-02	4E-02	4E-02
Nickel	N	2E-02	2E-02	3E-02	3E-02	6E-02	6E-02	8E-03	8E-03
Selenium	N	6E-01	6E-01	4E-01	4E-01	1E+00	1E+00	5E-02	5E-02
Silver	N	5E-01	5E-01	1E-03	1E-03	6E-01	6E-01	4E-02	4E-02
Thallium	Y	1E+00	1E+00	7E-01	7E-01	2E+00	2E+00	2E-01	2E-01
Vanadium	Y	8E+00	8E+00	2E-01	2E-01	1E+01	1E+01	4E-01	4E-01
Zinc	Y	2E+00	2E+00	3E+00	3E+00	3E+00	3E+00	2E-01	2E-01

NOAEL = No Observed Adverse Effect Level

COPC = Constituent of Potential Concern

TRV = Toxicity Reference Value

HQ = Hazard Quotient (Exposure/TRV)

COC = Constituent of concern

(1) COPC considered a preliminary COC if NOAEL HQ > 1 or HQ=1 for any receptor

(2) HQs based on the maximum detected concentrations.

Note: HQ>1 and HQ=1 are in bold.

TABLE J-15A
RECEPTOR LOAEL HAZARD QUOTIENTS BASED ON MAXIMUM CONCENTRATION - SEAD-59 SOIL
SEAD-59 and SEAD-71 Phase II RI Report

COPC	Retained as Final COC ⁽¹⁾ Y/N	Deer Mouse Surface Soil LOAEL HQ	Deer Mouse Mixed Surface and Subsurface Soil LOAEL HQ	American Robin Surface Soil LOAEL HQ	American Robin Mixed Surface and Subsurface Soil LOAEL HQ	Short-Tailed Shrew Surface Soil LOAEL HQ	Short-Tailed Shrew Total Soil LOAEL HQ	Red Fox Surface Soil LOAEL HQ	Red Fox Total Soil LOAEL HQ
Semi-Volatile Organic Compounds									
Phenanthrene	N					1.E-01	1.E-01		
Pesticides									
4,4'-DDE	N			2.E-01	2.E-01	1.E-01	1.E-01		
4,4'-DDT	N	4.E-01	4.E-01	7.E+01	7.E+01	5.E-01	5.E-01		
Metals									
Antimony	N	3.E+01	3.E+01			4.E+01	4.E+01	2.E+00	2.E+00
Arsenic	N	1.E+00	1.E+00			2.E+00	2.E+00		
Cadmium	N					1.E-01	1.E-01		
Cobalt	N	1.E-01	1.E-01			2.E-01	2.E-01		
Lead	N			1.E-01	1.E-01				
Silver	N					1.E-01	1.E-01		
Thallium	N					2.E-01	2.E-01		
Vanadium	N	9.E-01	9.E-01			1.E+00	1.E+00		

LOAEL = Lowest Observed Adverse Effect Level

COPC = Constituent of Potential Concern

SEV = Screening Ecotoxicity Value

HQ = Hazard Quotient (Exposure/SEV)

COC = Constituent of concern

(1) See text for the rationale.

(2) HQs based on the maximum detected concentrations

Note: HQ>1 and HQ=1 are in bold.

**TABLE J-15B
RECEPTOR LOAEL HAZARD QUOTIENTS BASED ON MAXIMUM CONCENTRATION - SEAD-59 STOCKPILE SOIL
SEAD-59 AND SEAD-71 PHASE II RI REPORT**

COPC	Retained as Final		Deer Mouse	American Robin	Short-Tailed Shrew	Red Fox
	COC ⁽¹⁾	Y/N	Surface Soil LOAEL HQ	Surface Soil LOAEL HQ	Surface Soil LOAEL HQ	Surface Soil LOAEL HQ
Semi-Volatile Organic Compounds						
Pyrene	N				1.1E-01	
Pesticides						
4,4'-DDT	N			1E+01		
Inorganics						
Antimony	N		3.0E+00		5.6E-01	2.0E-01
Arsenic	N		2.4E-01		5.1E-02	
Lead	N		2.1E-01	1E+00	4.1E+00	
Silver	N		1.2E-01		6.1E-02	
Vanadium	N		1.1E+00		2E+00	

LOAEL = Lowest Observed Adverse Effect Level

COPC = Constituent of Potential Concern

SEV = Screening Ecotoxicity Value

HQ = Hazard Quotient (Exposure/SEV)

COC = Constituent of concern

(1) See text for the rationale.

(2) HQs based on the maximum detected concentrations

Note: HQ>1 and HQ=1 are in bold.

TABLE J-15C
RECEPTOR LOAEL HAZARD QUOTIENTS BASED ON MAXIMUM CONCENTRATION - SEAD-71 (FENCED AREA EXCLUDED)
SEAD-59 and SEAD-71 Phase II RI Report

COPC	Retained as Preliminary COC ⁽¹⁾ Y/N	Deer Mouse	Deer Mouse	American Robin	American Robin	Short-Tailed Shrew	Short-Tailed Shrew
		Surface Soil Maximum LOAEL HQ	Total Soil Maximum LOAEL HQ	Surface Soil Maximum LOAEL HQ	Total Soil Maximum LOAEL HQ	Surface Soil Maximum LOAEL HQ	Total Soil Maximum LOAEL HQ
Semi-Volatile Organic Compounds							
Benzo(a)anthracene	N					1E-01	1E-01
Benzo(a)pyrene	N					1E-01	1E-01
Benzo(b)fluoranthene	N					1E-01	1E-01
Chrysene	N					1E-01	1E-01
Phenanthrene	N	2E-01	2E-01			3E-01	3E-01
Pyrene	N	2E-01	2E-01			3E-01	3E-01
Pesticides							
4,4'-DDT	N			2E+00	2E+00		
Inorganics							
Antimony	N	8E-01	8E-01			1E+00	1E+00
Arsenic	N	5E-01	5E-01			8E-01	8E-01
Lead	N	2E-01	2E-01	7E-01	7E-01	3E-01	3E-01
Thallium	N	1E-01	1E-01			2E-01	2E-01
Vanadium	N	8E-01	8E-01			1E+00	1E+00
Zinc	N	9E-01	9E-01	3E+00	3E+00	1E+00	1E+00

LOAEL = Lowest Observed Adverse Effect Level

COPC = Constituent of Potential Concern

SEV = Screening Ecotoxicity Value

HQ = Hazard Quotient (Exposure/SEV)

COC = Constituent of concern

(1) See text for the rationale.

(2) HQs based on the maximum detected concentrations

Note: HQ>1 and HQ=1 are in bold.

Table J-16A
Average Concentration for Preliminary COCs SEAD-59 Soil
SEAD-59 and SEAD-71 Phase II RI Report

Preliminary COC	Average Concentration	
	Surface Soil 0-2 ft bgs. (mg/kg)	Surface Soil & Subsurface Soil 0-4 ft bgs. (mg/kg)
Semi-Volatile Organic Compounds		
Phenanthrene	0.85	0.82
Pesticides		
4,4'-DDE	0.036	0.035
4,4'-DDT	0.049	0.047
Inorganics		
Antimony	3.60	3.30
Arsenic	5.44	5.39
Cadmium	0.45	0.43
Cobalt	9.55	9.53
Lead	28.44	27.50
Silver	0.73	0.70
Thallium	0.26	0.25
Vanadium	19.26	19.05

COC = Constituent of Concern

Table J-16B
Average Concentration for Preliminary COCs SEAD-59 Stockpile Soil
SEAD-59 AND SEAD-71 PHASE II RI REPORT

Preliminary COC	Average Concentration
	SEAD-59 Stockpile Soil (mg/kg)
Semi-Volatile Organic Compounds	
Pyrene	8.41
Pesticides	
4,4'-DDT	0.064
Inorganics	
Antimony	2.43
Arsenic	4.78
Lead	79.18
Manganese	522.23
Silver	0.39
Vanadium	19.92

COC = Constituent of Concern

TABLE J-16C
Average Concentration for Preliminary COCs SEAD-71 Soil (Fenced Area Excluded)
SEAD-59 and SEAD-71 Phase II RI Report

Preliminary COC	Concentration - Fenced Area Excluded 0-2 ft bgs. mg/kg	Concentration - Fenced Area Excluded 0-4 ft bgs. mg/kg
Semi-Volatile Organic Compounds		
Benzo(a)anthracene	1.02	1.62
Benzo(a)pyrene	0.97	1.31
Benzo(b)fluoranthene	0.97	1.38
Chrysene	1.14	1.72
Phenanthrene	1.38	2.47
Pyrene	1.89	2.91
Pesticides		
4,4'-DDT	0.02	0.02
Inorganics		
Antimony	1.8	1.7
Arsenic	5.9	5.9
Lead	115	111
Thallium	0.4	0.4
Vanadium	19	19
Zinc	125	122

COC = Constituent of Concern

TABLE J-17A
RECEPTOR NOAEL HAZARD QUOTIENTS BASED ON AVERAGE CONCENTRATION - SEAD-59 SOIL
SEAD-59 and SEAD-71 Phase II RI Report

COPC	Retained as Final COC ⁽¹⁾ Y/N	Deer Mouse Surface Soil NOAEL HQ	Deer Mouse Mixed Surface and Subsurface Soil NOAEL HQ	American Robin Surface Soil NOAEL HQ	American Robin Mixed Surface and Subsurface Soil NOAEL HQ	Short-Tailed Shrew Surface Soil NOAEL HQ	Short-Tailed Shrew Total Soil NOAEL HQ	Red Fox Surface Soil NOAEL HQ	Red Fox Total Soil NOAEL HQ
Semi-Volatile Organic Compounds									
Phenanthrene	N					4.E-02	4.E-02		
Pesticides									
4,4'-DDE	N			1.E-02	1.E-02	2.E-02	2.E-02		
4,4'-DDT	N	2.E-02	2.E-02	5.E+00	4.E+00	3.E-02	3.E-02		
Metals									
Antimony	N	2.E+00	2.E+00			4.E+00	3.E+00	2.E-01	2.E-01
Arsenic	N	2.E+00	2.E+00			3.E+00	3.E+00		
Cadmium	N					2.E-01	2.E-01		
Cobalt	N	2.E-01	2.E-01			4.E-01	4.E-01		
Lead	N			1.E-01	1.E-01				
Silver	N					3.E-01	2.E-01		
Thallium	N					2.E-01	2.E-01		
Vanadium	N	6.E+00	6.E+00			1.E+01	1.E+01		

NOAEL = No Observed Adverse Effect Level

COPC = Constituent of Potential Concern

SEV = Screening Ecotoxicity Value

HQ = Hazard Quotient (Exposure/SEV)

COC = Constituent of concern

(1) See text for the rationale.

(2) HQs based on average concentrations.

Note: HQ>1 and HQ=1 are in bold.

TABLE J-17B
RECEPTOR HAZARD QUOTIENTS BASED ON AVERAGE CONCENTRATION - SEAD-59 STOCKPILE SOIL
SEAD-59 AND SEAD-71 PHASE II RI REPORT

COPC	Retained as Final COC ⁽¹⁾ Y/N	Deer Mouse	American Robin	Short-Tailed	Red Fox	Deer Mouse	American	Short-Tailed	Red Fox
		Stockpile Soil NOAEL AVERAGE HQ	Stockpile Soil NOAEL AVERAGE HQ	Shrew Stockpile Soil NOAEL AVERAGE HQ	Stockpile Soil NOAEL AVERAGE HQ	Stockpile Soil LOAEL AVERAGE HQ	Robin Stockpile Soil LOAEL AVERAGE HQ	Shrew Stockpile Soil LOAEL AVERAGE HQ	Stockpile Soil LOAEL AVERAGE HQ
Semi-Volatile Organic Compounds									
Pyrene	N			4.E-01				4.E-02	
Pesticides									
4,4'-DDT	N		6.E+00				6.E-01		
Inorganics									
Antimony	N	2.E+00		2.E+00	1.E-01	2.E-01		2.E-01	1.E-02
Arsenic	N	2.E+00		3.E+00		2.E-01		3.E-01	
Lead	N	1.E-01	3.E-01	2.E-01		1.E-02	3.E-02	2.E-02	
Silver	N	1.E-01		1.E-01		1.E-02		1.E-02	
Vanadium	N	6.E+00		1.E+01		6.E-01		1.E+00	

NOAEL = No Observed Adverse Effect Level
 LOAEL = Lowest Observed Adverse Effect Level
 COPC = Constituent of Potential Concern
 SEV = Screening Ecotoxicity Value
 HQ = Hazard Quotient (Exposure/SEV)
 COC = Constituent of concern
 (1) See text for the rationale.
 (2) HQs based on average concentrations.
 Note: HQ>1 and HQ=1 are in bold.

TABLE J-17C
RECEPTOR NOAEL HAZARD QUOTIENTS BASED ON AVERAGE CONCENTRATION - SEAD--71 SOIL (FENCED AREA EXCLUDED)
SEAD-59 and SEAD-71 Phase II RI Report

COPC	Retained as Preliminary COC ⁽¹⁾ Y/N	Deer Mouse Surface Soil Average NOAEL HQ	Deer Mouse Total Soil Average NOAEL HQ	American Robin Surface Soil Average NOAEL HQ	American Robin Total Soil Average NOAEL HQ	Short-Tailed Shrew Surface Soil Average NOAEL HQ	Short-Tailed Shrew Total Soil Average NOAEL HQ
Semi-Volatile Organic Compounds							
Benzo(a)anthracene	N					3E-02	5E-02
Benzo(a)pyrene	N					5E-02	6E-02
Benzo(b)fluoranthene	N					5E-02	7E-02
Chrysene	N					4E-02	6E-02
Phenanthrene	N	4E-02	7E-02			7E-02	1E-01
Pyrene	N	5E-02	8E-02			9E-02	1E-01
Pesticides							
4,4'-DDT	N			2E+00	2E+00		
Inorganics							
Antimony	N	1E+00	1E+00			2E+00	2E+00
Arsenic	N	2E+00	2E+00			3E+00	3E+00
Lead	N	2E-01	2E-01	4E-01	4E-01	4E-01	3E-01
Thallium	N	2E-01	2E-01			3E-01	3E-01
Vanadium	N	6E+00	6E+00			1E+01	1E+01
Zinc	N	1E-01	1E-01	1E-01	1E-01	2E-01	2E-01

NOAEL = No Observed Adverse Effect Level

COPC = Constituent of Potential Concern

SEV = Screening Ecotoxicity Value

HQ = Hazard Quotient (Exposure/SEV)

COC = Constituent of concern

(1) See text for the rationale.

(2) HQs based on average concentrations.

Note: HQ>1 and HQ=1 are in bold.

TABLE J-18A
RECEPTOR LOAEL HAZARD QUOTIENTS BASED ON AVERAGE CONCENTRATION - SEAD-59 SOIL
SEAD-59 and SEAD-71 Phase II RI Report

COPC	Retained as Final COC⁽¹⁾ Y/N	Deer Mouse Surface Soil LOAEL HQ	Deer Mouse Mixed Surface and Subsurface Soil LOAEL HQ	American Robin Surface Soil LOAEL HQ	American Robin Mixed Surface and Subsurface Soil LOAEL HQ	Short-Tailed Shrew Surface Soil LOAEL HQ	Short-Tailed Shrew Total Soil LOAEL HQ	Red Fox Surface Soil LOAEL HQ	Red Fox Total Soil LOAEL HQ
Semi-Volatile Organic Compounds									
Phenanthrene	N					4.E-03	4.E-03		
Pesticides									
4,4'-DDE	N			1.E-03	1.E-03	2.E-03	2.E-03		
4,4'-DDT	N	5.E-03	4.E-03	5.E-01	4.E-01	7.E-03	7.E-03		
Metals									
Antimony	N	2.E-01	2.E-01			4.E-01	3.E-01	2.E-02	2.E-02
Arsenic	N	2.E-01	2.E-01			3.E-01	3.E-01		
Cadmium	N					2.E-02	2.E-02		
Cobalt	N	2.E-02	2.E-02			4.E-02	4.E-02		
Lead	N			1.E-02	1.E-02				
Silver	N					3.E-02	2.E-02		
Thallium	N					2.E-02	2.E-02		
Vanadium	N	6.E-01	6.E-01			1.E+00	1.E+00		

LOAEL = Lowest Observed Adverse Effect Level

COPC = Constituent of Potential Concern

SEV = Screening Ecotoxicity Value

HQ = Hazard Quotient (Exposure/SEV)

COC = Constituent of concern

(1) See text for the rationale.

(2) HQs based on average concentrations.

Note: HQ>1 and HQ=1 are in bold.

TABLE J-18C
RECEPTOR LOAEL HAZARD QUOTIENTS BASED ON AVERAGE CONCENTRATION - SEAD-71 SOIL (FENCED AREA EXCLUDED)
SEAD-59 and SEAD-71 Phase II RI Report

COPC	Retained as Preliminary COC ⁽¹⁾ Y/N	Deer Mouse Surface Soil Average LOAEL HQ	Deer Mouse Total Soil Average LOAEL HQ	American Robin Surface Soil Average LOAEL HQ	American Robin Total Soil Average LOAEL HQ	Short-Tailed Shrew Surface Soil Average LOAEL HQ	Short-Tailed Shrew Total Soil Average LOAEL HQ
Semi-Volatile Organic Compounds							
Benzo(a)anthracene	N					3E-03	5E-03
Benzo(a)pyrene	N					5E-03	6E-03
Benzo(b)fluoranthene	N					5E-03	7E-03
Chrysene	N					4E-03	6E-03
Phenanthrene	N	4E-03	7E-03			7E-03	1E-02
Pyrene	N	5E-03	8E-03			9E-03	1E-02
Pesticides							
4,4'-DDT	N			2E-01	2E-01		
Inorganics							
Antimony	N	1E-01	1E-01			2E-01	2E-01
Arsenic	N	2E-01	2E-01			3E-01	3E-01
Lead	N	2E-02	2E-02	4E-02	4E-02	4E-02	3E-02
Thallium	N	2E-02	2E-02			3E-02	3E-02
Vanadium	N	6E-01	6E-01			1E+00	1E+00
Zinc	N	7E-02	6E-02	1E-01	1E-01	1E-01	1E-01

LOAEL = Lowest Observed Adverse Effect Level

COPC = Constituent of Potential Concern

SEV = Screening Ecotoxicity Value

HQ = Hazard Quotient (Exposure/SEV)

COC = Constituent of concern

(1) See text for the rationale.

(2) HQs based on average concentrations.

Note: HQ>1 and HQ=1 are in bold.

TABLE J-19A
Comparison of Site Concentrations with Background - SEAD-59 Soil
SEAD-59 and SEAD-71 Phase II RI Report

Preliminary COC	Maximum Detected Concentration		Average Concentration		Background (mg/kg)		
	Surface Soil 0-2 ft bgs. (mg/kg)	Total Soil 0-4 ft bgs. (mg/kg)	Surface Soil 0-2 ft bgs. (mg/kg)	Total Soil 0-4 ft bgs. (mg/kg)	Maximum	Average	95% UCL
Inorganics							
Antimony	424	424	3.60	3.30	6.55	2.7	3.3
Arsenic	32.2	32.2	5.44	5.39	21.5	5.2	5.97
Cadmium	3.2	3.2	0.45	0.43	2.9	0.54	0.74
Cobalt	47.8	47.8	9.55	9.53	29.1	11.5	12.66
Lead	164	164	28.4	27.50	266	17.7	27.6
Silver	2.9	2.9	0.73	0.70	0.87	0.38	0.45
Thallium	1.8	1.8	0.26	0.25	1.2	0.255	0.32
Vanadium	28.5	28.5	19.3	19.05	32.7	21.2	22.9

COC = Constituent of concern

TABLE J-19B
Comparison of Site Concentrations with Background - SEAD-59 Stockpile Soil
SEAD-59 and SEAD-71 Phase II RI Report

Preliminary COC	Maximum Detected Concentration	Average Concentration	Background (mg/kg)		
	Stockpile Soil (mg/kg)	Stockpile Soil (mg/kg)	Maximum	Average	95% UCL
Inorganics					
Antimony	43.9	2.43	6.55	2.7	3.3
Arsenic	7.3	4.78	21.5	5.2	5.97
Lead	1440	79.18	266	17.7	27.6
Manganese	1220	522.23	2380	609	701
Silver	4.7	0.39	0.87	0.38	0.45
Vanadium	35.4	19.92	32.7	21.2	22.9

COC = Constituent of concern

TABLE J-19C
Comparison of Site Concentrations with Background - SEAD-71 Soil
SEAD-59 and SEAD-71 Phase II RI Report

Preliminary COC	Maximum Detected Concentration		Average Concentration		Background (mg/kg)		
	Surface Soil 0-2 ft bgs. (mg/kg)	Total Soil 0-4 ft bgs. (mg/kg)	Surface Soil 0-2 ft bgs. (mg/kg)	Total Soil 0-4 ft bgs. (mg/kg)	Maximum	Average	95% UCL
Inorganics							
Antimony	11.5	11.5	1.8	1.7	6.55	2.7	3.3
Arsenic	14.6	14.6	5.9	5.9	21.5	5.2	5.97
Lead	1010	1010	115	111	266	17.7	27.6
Thallium	2.3	2.3	0.37	0.35	1.2	0.255	0.32
Vanadium	24	24	19	19	32.7	21.2	22.9
Zinc	1740	1740	125	122	126	71.7	77.5

COC = Constituent of concern

Appendix K

Copy of Table 1 from ENSR 2002 Removal Report

**Table 1
SUMMARY TABLE**

Sample Date	Sample (pile) Identification	Laboratory ID	Area Removed From	Excedence Analyte	Observed Concentration, mg/kg	Cleanup Goal	Cleanup Goal Suite	TCLP	Waste Profile Suite	Final Disposition
9/16/02	WS-59-OtherC-001-1	584344	59 Other C	Hg	0.16	0.13	X	X	X	BACKFILL
9/16/02	CL-59-OtherC-WE1	584348	NAP	Zn	175	126	X			NAP
				Hg	0.17	0.13				
				Cr	51.3	32.7				
9/16/02	CL-59-OtherC-WN1	584349	NAP				X			NAP
9/16/02	FD-59-CL-01	584351	NAP				X			NAP
9/16/02	CL-59-OtherC-VV1	584352	NAP				X			NAP
9/16/02	CL-59-OtherC-F01	584354	NAP				X			NAP
9/16/02	CL-59-OtherC-WS1	584357	NAP	Hg	0.17	0.13	X			NAP
9/16/02	WS-59-03-001-1	584360	59 Area 3				X	X	X	BACKFILL
9/17/02	WS-59-03-001-2	584658	59 Area 3				X	X	X	BACKFILL
9/17/02	WS-59-03-001-3	584659	59 Area 3				X	X	X	BACKFILL
9/17/02	FD-59-WS-01	584660	NAP				X	X	X	NAP
9/17/02	WS-59-03-002-1	584661	59 Area 3				X	X	X	BACKFILL
9/17/02	WS-59-03-002-2	584662	59 Area 3				X	X	X	BACKFILL
9/17/02	WS-59-03-002-4	584663	59 Area 3				X	X	X	BACKFILL
9/17/02	WS-59-03-002-3	584664	59 Area 3				X	X	X	BACKFILL
9/17/02	CL-59-03-F01	584665	NAP				X			NAP
9/17/02	CL-59-03-F02	584666	NAP				X			NAP

**Table 1
SUMMARY TABLE**

Sample Date	Sample (pile) Identification	Laboratory ID	Area Removed From	Excedence Analyte	Observed Concentration, mg/kg	Cleanup Goal	Cleanup Goal Suite	TCLP	Waste Profile Suite	Final Disposition
9/17/02	CL-59-03-F03	584667	NAP				X			NAP
9/18/02	WS-59-02-002-1	585277	59 Area 2				X	X	X	BACKFILL
9/18/02	WS-59-02-002-2	585278	59 Area 2				X	X	X	BACKFILL
9/18/02	WS-59-02-002-3	585279	59 Area 2				X	X	X	BACKFILL
9/18/02	WS-59-02-003-1	585280	59 Area 2				X	X	X	BACKFILL
9/18/02	WS-59-02-003-2	585281	59 Area 2				X	X	X	BACKFILL
9/18/02	WS-59-02-003-3	585282	59 Area 2				X	X	X	BACKFILL
9/18/02	WS-59-02-003-4	585283	59 Area 2				X	X	X	BACKFILL
9/18/02	WS-59-02-003-5	585284	59 Area 2				X	X	X	BACKFILL
9/18/02	WS-59-02-004-1	585285	59 Area 2				X	X	X	BACKFILL
9/19/02	CL-59-0A-F01	A1380-05A	NAP	Ag	1.8	0.87	X			NAP
9/19/02	CL-59-0A-WE1	A1380-04A	NAP	Ag	2.5	0.87	X			NAP
9/19/02	CL-59-0A-WN1	A1380-01A	NAP	Hg	0.14	0.13	X			NAP
				Ag	2.9	0.87				
9/19/02	CL-59-0A-WS1	A1380-03A	NAP	Hg	0.14	0.13	X			NAP
				Ag	2.8	0.87				
9/19/02	CL-59-0A-WW1	A1380-02A	NAP	Ag	2.6	0.87	X			NAP
9/19/02	CL-59-0B-F01	A1380-06A	NAP	Ag	2	0.87	X			NAP

**Table 1
SUMMARY TABLE**

Sample Date	Sample (pile) Identification	Laboratory ID	Area Removed From	Excedence Analyte	Observed Concentration, mg/kg	Cleanup Goal	Cleanup Goal Suite	TCLP	Waste Profile Suite	Final Disposition
9/19/02	CL-59-0B-WE1	A1380-09A	NAP	Ag	2.1	0.87	X			NAP
9/19/02	CL-59-0B-WN1	A1380-07A	NAP	Ag	2.5	0.87	X			NAP
9/19/02	CL-59-0B-WS1	A1380-10A	NAP	Ag	2.3	0.87	X			NAP
9/19/02	CL-59-0B-WW1	A1380-08A	NAP	Ag	1.7	0.87	X			NAP
9/19/02	CL-59-02-F01	A1377-17A	NAP	Ag	2.2	0.87	X			NAP
9/19/02	CL-59-02-F02	A1377-18A	NAP	Ag	1.4	0.87	X			NAP
9/19/02	CL-59-02-WE1	A1377-15A	NAP	Ag	1.6	0.87	X			NAP
9/19/02	CL-59-02-WE2	A1377-16A	NAP				X			NAP
9/19/02	CL-59-02-WN1	A1377-13A	NAP	Ag	1.9	0.87	X			NAP
9/19/02	CL-59-02-WN2	A1377-14A	NAP	Ag	1.1	0.87	X			NAP
9/19/02	CL-59-02-WS1	A1377-10A	NAP	Ag	1.9	0.87	X			NAP
9/19/02	CL-59-02-WS2	A1377-09A	NAP	Ag	1.1	0.87	X			NAP
9/19/02	CL-59-02-WW1	A1377-11A	NAP				X			NAP
9/19/02	CL-59-02-WW2	A1377-12A	NAP	Ag	2.6	0.87	X			NAP
9/19/02	CL-59-02-WE1	A1377-01A	NAP	Ag	2.4	0.87	X			NAP
9/19/02	CL-59-03-WN1	A1377-02A	NAP	Ag	2.5	0.87	X			NAP
9/19/02	CL-59-03-WN2	A1377-03A	NAP	Ag	1.1	0.87	X			NAP
9/19/02	CL-59-03-WN3	A1377-04A	NAP				X			NAP

Table 1
SUMMARY TABLE

Sample Date	Sample (pile) Identification	Laboratory ID	Area Removed From	Excedence Analyte	Observed Concentration, mg/kg	Cleanup Goal	Cleanup Goal Suite	TCLP	Waste Profile Suite	Final Disposition
9/19/02	CL-59-03-WS1	A1377-05A	NAP				X			NAP
9/19/02	CL-59-03-WS2	A1377-06A	NAP				X			NAP
9/19/02	CL-59-03-WS3	A1377-07A	NAP	Ag	1.3	0.87	X			NAP
9/19/02	CL-59-03-WW1	A1377-08A	NAP	Ag	2.1	0.87	X			NAP
9/19/02	FD-59-CL-02	A1377-19A	NAP				X			NAP
9/19/02	WS-59-01-004-2	585662	59 Area1	Benzo(A) Anthracene	9	8.8	X	X	X	OFF SITE
				Benzo(A) Pyrene	9	0.88				
				Chrysene	9	7.1				
				Dibenzo(A,H) Anthracene	1.9 J	0.88				
9/19/02	WS-59-01-004-3	585663	59 Area 1	Benzo(A) Anthracene	9.5	8.8	X	X	X	OFF SITE
				Benzo(A) Pyrene	15	0.88				
				Benzo(B) Fluoranthene	11	8.8				
				Indeno (1,2,3-CD) Pyrene	8.8	8.8				
				Chrysene	9.7	7.1				
				Dibenzo(A,H) Anthracene	3.2	0.88				
9/19/02	WS-59-01-004-4	585664	59 Area 1	Pb	47.7		X	X	X	OFF SITE
				Benzo(A) Pyrene	4.7					
				Benzo(B) Fluoranthene	3.5					
				Benzo(K) Fluoranthene	3.6					
				Chrysene	4.4					
				Dibenzo(A,H) Anthracene	0.99 J					
9/19/02	WS-59-01-004-5	585665	59 Area 1	Benzo(A) Pyrene	4.3	0.88	X	X	X	OFF SITE
				Dibenzo(A,H) Anthracene	1	0.88				
9/19/02	WS-59-01-004-6	585666	59 Area 1	Hg	0.14	0.13	X	X	X	OFF SITE

**Table 1
SUMMARY TABLE**

Sample Date	Sample (pile) Identification	Laboratory ID	Area Removed From	Excedence Analyte	Observed Concentration, mg/kg	Cleanup Goal	Cleanup Goal Suite	TCLP	Waste Profile Suite	Final Disposition
				Benzo(A) Pyrene	1.5	0.88				
	WS-59-01-003-6	585667	59 Area 1	Benzo(A) Pyrene	7	0.88	X	X	X	OFF SITE
				Dibenzo(A,H) Anthracene	1.5 J	0.88				
9/19/02	FD-59-WS-02	585668	NAP	Hg	0.18	0.13	X	X	X	NAP
				Benzo(A) Pyrene	2.8	0.88				
9/19/02	WS-59-01-003-7	585669	59 Area 1	Zn	132	126	X	X	X	OFF SITE
				Benzo(A) Pyrene	3.1	0.88				
9/19/02	WS-59-01-005-1	585670	59 Area 1				X	X	X	OFF SITE
9/19/02	WS-59-01-005-2	585671	59 Area 1	Benzo(A) Pyrene	3.3	0.88	X	X	X	OFF SITE
9/19/02	WS-59-01-005-3	585672	59 Area 1	Benzo(A) Anthracene	2.6	0.88	X	X	X	OFF SITE
9/19/02	WS-59-01-005-4	585673	59 Area 1	Benzo(A) Pyrene	1.8	0.88	X	X	X	STOCKPILE
9/20/02	WS-59-01-005-5	586079	59 Area 1				X	X	X	STOCKPILE
9/20/02	WS-59-01-005-6	586080	59 Area 1	Hg	0.14	0.13	X	X	X	OFF SITE
				Benzo(A) Pyrene	1.1	0.88				
9/20/02	WS-59-01-005-7	586081	59 Area 1	Benzo(A) Pyrene	1.4	0.88	X	X	X	OFF SITE
9/20/02	WS-59-01-005-8	586082	59 Area 1	Benzo(A) Pyrene	5.5	0.88	X	X	X	OFF SITE
				Dibenzo(A,H) Anthracene	1.3 J	0.88				
9/20/02	WS-59-01-005-9	586083	59 Area 1	Benzo(A) Anthracene	9.1	8.8	X	X	X	OFF SITE
				Benzo(A) Pyrene	10	0.88				
				Chrysene	8.8	7.1				
				Dibenzo(A,H) Anthracene	2.3	0.88				
9/20/02	WS-59-01-005-10	586084	59 Area 1	Sb	10.2	6.8	X	X	X	OFF SITE

**Table 1
SUMMARY TABLE**

Sample Date	Sample (pile) Identification	Laboratory ID	Area Removed From	Excedence Analyte	Observed Concentration, mg/kg	Cleanup Goal	Cleanup Goal Suite	TCLP	Waste Profile Suite	Final Disposition
				Benzo(A) Pyrene	12	0.88				
				Chrysene	10	7.1				
				Dibenzo(A,H) Anthracene	2.7	0.88				
9/20/02	WS-59-01-006-1	586085	59 Area 1	Benzo(A) Pyrene	6	0.88	X	X	X	STOCKPILE
				Dibenzo(A,H) Anthracene	1.4 J	0.88				
9/20/02	WS-59-01-006-2	586086	59 Area 1	Benzo(A) Pyrene	2.8	0.88	X	X	X	BACKFILL
9/20/02	WS-59-01-006-3	586088	59 Area 1	Benzo(A) Pyrene	6.9	0.88	X	X	X	STOCKPILE
				Dibenzo(A,H) Anthracene	1.6 J	0.88				
9/20/02	WS-59-01-006-4	586090	59 Area 1	Benzo(A) Pyrene	3.1	0.88	X	X	X	BACKFILL
9/23/02	FD-WS-03	586521	NAP	Zinc	135	126	X			NAP
				Benzo(A) Pyrene	2.4	0.88				
9/23/02	WS-59-01-006-10	586518	59 Area 1	Zinc	163	126	X	X	X	OFF SITE
				Benzo(A) Anthracene	39	8.8				
				Benzo(A) Pyrene	37	0.88				
				Benzo(B) Fluoranthene	26	8.8				
				Benzo(K) Fluoranthene	27	19				
				Chrysene	38	7.1				
				Indeno (1,2,3-CD) Pyrene	19	8.88				
				Dibenzo(A,H) Anthracene	7.1	0.88				
				Fluoranthene	82	50				
				Phenanthrene	87	50				
				Pyrene	77	50				
				Dibenzofuran	6.7					
9/23/02	WS-59-01-006-11	586519	59 Area 1	Benzo(A) Pyrene	3.8	0.88	X		X	BACKFILL
				Dibenzo(A,H) Anthracene	0.9 J	0.88				
9/23/02	WS-59-01-006-12	586520	59 Area 1	Benzo(A) Pyrene	6.4	0.88	X		X	STOCKPILE
				Dibenzo(A,H) Anthracene	1.5 J	0.88				

**Table 1
SUMMARY TABLE**

Sample Date	Sample (pile) Identification	Laboratory ID	Area Removed From	Excedence Analyte	Observed Concentration, mg/kg	Cleanup Goal	Cleanup Goal Suite	TCLP	Waste Profile Suite	Final Disposition
9/23/02	WS-59-01-006-5	586513	59 Area 1	Benzo(A) Pyrene	3.9	0.88	X		X	BACKFILL
				Dibenzo(A,H) Anthracene	0.94 J	0.88				
9/23/02	WS-59-01-006-6	586514	59 Area 1	Mercury	0.23	0.13	X		X	BACKFILL
				Benzo(A) Pyrene	1.6	0.88				
9/23/02	WS-59-01-006-7	586515	59 Area 1	Benzo(A) Pyrene	5.4	0.88	X		X	STOCKPILE
				Dibenzo(A,H) Anthracene	1.4 J	0.88				
9/23/02	WS-59-01-006-8	586516	59 Area 1	Benzo(A) Pyrene	2.3	0.88	X	X	X	BACKFILL
				Zinc	135	126				
9/23/02	WS-59-01-006-9	586517	59 Area 1	Zinc	185	126	X	X	X	STOCKPILE
				Benzo(A) Pyrene	7.4	0.88				
				Dibenzo(A,H) Anthracene	1.5 J	0.88				
9/23/02	WS-59-01-007-1	586522	59 Area 1	Silver	1.1	0.87	X		X	STOCKPILE
				Benzo(A) Pyrene	5.4	0.88				
				Dibenzo(A,H) Anthracene	1.1 J	0.88				
9/23/02	WS-59-01-007-2	586525	59 Area 1	Benzo(A) Pyrene	4.6	0.88	X		X	STOCKPILE
9/24/02	WS-59-01-007-10	587004	59 Area 1				X		X	STOCKPILE
9/24/02	WS-59-01-007-11	587005	59 Area 1				X		X	STOCKPILE
9/24/02	WS-59-01-007-12	587006	59 Area 1	Benzo(A) Pyrene	5.9	0.88	X		X	STOCKPILE
				Dibenzo(A,H) Anthracene	1.1 J	0.88				
9/24/02	WS-59-01-007-13	587007	59 Area 1	Benzo(A) Pyrene	4.3	0.88	X		X	STOCKPILE
9/24/02	WS-59-01-007-14	587008	59 Area 1	Benzo(A) Anthracene	13	8.8*	X	X	X	STOCKPILE
				Benzo(A) Pyrene	14	0.88				
				Benzo(B) Fluoranthene	9.8	8.8				

**Table 1
SUMMARY TABLE**

Sample Date	Sample (pile) Identification	Laboratory ID	Area Removed From	Excedence Analyte	Observed Concentration, mg/kg	Cleanup Goal	Cleanup Goal Suite	TCLP	Waste Profile Suite	Final Disposition
				Chrysene	13	7.1				
				Dibenzo(A,H) Anthracene	2.5 J	0.88				
9/24/02	WS-59-01-007-3	586997	59 Area 1	Zinc	133	126	X			BACKFILL
				Benzo(A) Pyrene	3.2	0.88				
9/24/02	WS-59-01-007-4	586998	59 Area 1	Benzo(A) Pyrene	2.4 J	0.88	X		X	BACKFILL
9/24/02	WS-59-01-007-5	586999	59 Area 1	Benzo(A) Pyrene	4.4	0.88	X		X	STOCKPILE
				Dibenzo(A,H) Anthracene	0.94 J	0.88				
9/24/02	WS-59-01-007-6	587000	59 Area 1	Benzo(A) Pyrene	3.6	0.88	X		X	STOCKPILE
9/24/02	WS-59-01-007-7	587001	59 Area 1	Benzo(A) Pyrene	2.5 J	0.88	X	X	X	BACKFILL
9/24/02	WS-59-01-007-8	587002	59 Area 1	Benzo(A) Pyrene	8.2	0.88	X	X	X	STOCKPILE
				Dibenzo(A,H) Anthracene	1.6 J	0.88				
9/24/02	WS-59-01-007-9	587003	59 Area 1	Benzo(A) Pyrene	3	0.88	X		X	BACKFILL
9/25/02	WS-59-01-008-1	587661	59 Area 1	Benzo(A) Pyrene	5.8	0.88	X		X	STOCKPILE
				Dibenzo(A,H) Anthracene	1.2 J	0.88				
9/25/02	WS-59-01-008-2	587663	59 Area 1	Benzo(A) Pyrene	11	0.88	X	X	X	STOCKPILE
				Chrysene	8.5	7.1				
				Dibenzo(A,H) Anthracene	2.2 J	0.88				
9/25/02	WS-59-01-008-3	587665	59 Area 1	Benzo(A) Pyrene	9.4	0.88	X		X	STOCKPILE
				Chrysene	7.9	7.1				
				Dibenzo(A,H) Anthracene	1.9 J	0.88				
9/25/02	WS-59-01-004-7	587666	59 Area 1	Benzo(A) Pyrene	0.35	0.88	X		X	BACKFILL
9/25/02	WS-71-D-009-2	587667	71 Area D	Benzo(A) Pyrene	1.5	0.88	X	X	X	BACKFILL

**Table 1
SUMMARY TABLE**

Sample Date	Sample (pile) Identification	Laboratory ID	Area Removed From	Excedence Analyte	Observed Concentration, mg/kg	Cleanup Goal	Cleanup Goal Suite	TCLP	Waste Profile Suite	Final Disposition
9/25/02	WS-71-E2-009-2	587668	71 Area E2	Copper	86.4	62.8	X	X	X	OFF SITE
				Lead	588	400				
				Zinc	156	126				
9/25/02	FD-59--WS-04	587669	NAP	Benzo(A) Pyrene	1.1	0.88	X			NAP
9/25/02	WS-71-E1-009-3	587670	71 Area E1	Copper	102	62.8	X		X	STOCKPILE
9/25/02	59-01-WN1	A1406-01A	NAP	Zinc	147	126	X			NAP
9/25/02	59-01-WN2	A1406-04A	NAP	4-Chloroaniline	1.3	0.22	X			NAP
				Arsenic	32.2	21.5				
				Beryllium	2.6	1.4				
				Chromium	39.3	32.7				
				Cobalt	47.8	30				
				Copper	194	62.8				
				Iron	64000	38600				
				Mercury	0.15	0.13				
				Nickel	88.3	62.8				
				Silver	2.3	0.87				
				Zinc	298	126				
9/25/02	59-01-WN3	A1406-05A	NAP				X			NAP
9/25/02	59-01-WW1	A1406-02A	NAP	Mercury	0.15	0.13	X			NAP
				Silver	1.9	0.87				
9/25/02	59-01-WW2	A1406-03A	NAP	Silver	2.1	0.87	X			NAP
9/25/02	59-01-WW3	A1406-05A	NAP	Mercury	0.13	0.13	X			NAP
				Silver	1.9	0.87				
9/25/02	59-01-WW4	A1406-06A	NAP	Mercury	0.24	0.13	X			NAP
				Silver	1.2	0.87				

**Table 1
SUMMARY TABLE**

Sample Date	Sample (pile) Identification	Laboratory ID	Area Removed From	Excedence Analyte	Observed Concentration, mg/kg	Cleanup Goal	Cleanup Goal Suite	TCLP	Waste Profile Suite	Final Disposition
9/25/02	FD-59-CL-03	A1406-07A	NAP	Silver	1.5	0.87	X			NAP
9/25/02	CL-71-D-F1	A1406-12A	NAP				X			NAP
9/25/02	CL-71-D-WE1	A1406-08A	NAP	Silver	1.1	0.87	X			NAP
9/25/02	CL-71-D-WS1	A1406-10A	NAP	Silver	0.96	0.87	X			NAP
9/25/02	CL-71-D-WW1	A1406-09A	NAP	Antimony	93.1	6.8	X			
				Chromium	43.1	32.7				NAP
				Copper	740	62.8				
				Lead	15700	1250				
				Silver	1.2	0.87				
				Zinc	204	126				
9/26/02	CL-71-C-WN1	588279	NAP	Chromium	37.1	32.7	X			NAP
				Copper	67.6	62.8				
				Zinc	162	126				
				Benzo(A) Pyrene	6.5	0.88				
				Chrysene	6.3	2.3				
				Dibenzo(A,H) Anthracene	1.7 J	0.88				
9/26/02	CL-71-C-WW2	588280	NAP				X			NAP
9/26/02	CL-71-C-WE1	588281	NAP				X			NAP
9/26/02	CL-71-C-WS1	588282	NAP	Zinc	357	126	X			NAP
				Benzo(A) Anthracene	10	8.8				
				Benzo(A) Pyrene	9	0.88				
				Benzo(B) Fluoranthene	6.7	6.4				
				Benzo(K) Fluoranthene	7.7	6.4				
				Chrysene	10	2.3				
				Dibenzo(A,H) Anthracene	1.9 J	0.88				
9/26/02	CL-71-C-WW1	588283	NAP				X			NAP

Table 1
SUMMARY TABLE

Sample Date	Sample (pile) Identification	Laboratory ID	Area Removed From	Excedence Analyte	Observed Concentration, mg/kg	Cleanup Goal	Cleanup Goal Suite	TCLP	Waste Profile Suite	Final Disposition
9/26/02	CL-71-C-WE2	588284	NAP				X			NAP
9/26/02	CL-71-C-FO1	588285	NAP	Benzo(A) Pyrene	0.8	0.88	X			NAP
9/26/02	CL-71-C-FO2	588286	NAP				X			NAP
9/26/02	CL-71-E1-FO1	588287	NAP				X			NAP
9/26/02	CL-71-E1-WE1	588288	NAP				X			NAP
9/26/02	CL-71-A-WE1	A1418-06A	NAP				X			NAP
9/26/02	CL-59-01-F01	A1418-11A	NAP	Silver	0.98 B	0.87	X			NAP
9/26/02	CL-59-01-F02	A1418-13A	NAP	Silver	1.4	0.87	X			NAP
9/26/02	CL-71-A-F01	A1418-07A	NAP	Silver	1.6 B	0.87	X			NAP
9/26/02	CL-71-A-WN1	A1418-01A	NAP				X			NAP
9/26/02	CL-71-A-WS1	A1418-05A	NAP	Silver	1.4 B	0.87	X			NAP
9/26/02	CL-71-A-WW1	A1418-08A	NAP	Silver	0.92 B	0.87	X			NAP
9/26/02	CL-71-B-F01	A1418-10A	NAP				X			NAP
9/26/02	CL-71-B-WN1	A1418-09A	NAP	Silver	1.2 B	0.87	X			NAP
				Benzo(A) Pyrene	3.1 E	0.88				
				Chrysene	2.9 E	2.3				
9/26/02	CL-71-E1-WN1	A1418-02A	NAP	Silver	1.8	0.87	X			NAP
9/26/02	CL-71-E1-WS1	A1418-04A	NAP	Silver	1.7	0.87	X			NAP

Table 1
SUMMARY TABLE

Sample Date	Sample (pile) Identification	Laboratory ID	Area Removed From	Excedence Analyte	Observed Concentration, mg/kg	Cleanup Goal	Cleanup Goal Suite	TCLP	Waste Profile Suite	Final Disposition
9/26/02	CL-71-E1-WW1	A1418-03A	NAP	Silver	1.6	0.87	X			NAP
9/26/02	FD-71-CL-04	A1418-12A	NAP				X			NAP
9/27/02	CL-59-04-F01	A1424-01A	NAP	Silver	1.6	0.87	X			NAP
9/27/02	CL-59-04-WN1	A1424-02A	NAP				X			NAP
9/27/02	CL-59-04-WN2	A1424-03A	NAP				X			NAP
9/27/02	CL-71-B-WE1	A1424-04A	NAP	Antimony	86.9 N	6.8	X			NAP
				Barium	428	300				
				Copper	419	62.8				
				Lead	6820	1250				
				Mercury	7.8	0.13				
				Zinc	343	2126				
9/27/02	CL-71-B-WW1	A1424-05A	NAP				X			NAP
9/27/02	CL-71-B-WW2	A1424-06A	NAP				X			NAP
9/27/02	CL-71-B-WE2	A1424-07A	NAP	Antimony	11.5 N	6.8	X			NAP
				Lead	635	400				
				Mercury	0.43	0.13				
				Zinc	128	126				
				Benzo(A) Pyrene	1.4	0.88				
9/27/02	CL-71-B-WS1	A1424-08A	NAP	Mercury	1	0.13	X			NAP
9/27/02	CL-71-E2-WN1	A1424-09A	MAP	Silver	1.4 B	0.87	X			NAP
9/27/02	CL-71-E2-F01	A1424-10A	NAP	Silver	1.0 B	0.87	X			NAP
				Benzo(A) Anthracene	0.32 J	8.8				
9/30/02	CL-59-04-WS2	A1423-01A	NAP				X			NAP

**Table 1
SUMMARY TABLE**

Sample Date	Sample (pile) Identification	Laboratory ID	Area Removed From	Excedence Analyte	Observed Concentration, mg/kg	Cleanup Goal	Cleanup Goal Suite	TCLP	Waste Profile Suite	Final Disposition
9/30/02	WS-71-B-009-8	A1423-02A	71 Area B	Copper	98.2	62.8	X	X	X	BACKFILL
				Mercury	0.31	0.13				
				Benzo(A) Pyrene	1.4	0.88				
9/30/02	WS-71-A-009-09	A1423-03A	71 Area A	Silver	0.88 B	0.87	X	X	X	BACKFILL
9/30/02	CL-59-04-WE1	A1423-04A	NAP				X			NAP
9/30/02	CL-59-04-F04	A1423-05A	NAP				X			NAP
9/30/02	CL-59-04-WW1	A1423-06A	NAP	Silver	1.7	0.87	X			NAP
9/30/02	WS-71-B-009-7	A1423-07A	71 Area B	Antimony	33.7 N	6.8	X	X	X	OFF SITE
				Copper	103	62.8				
				Lead	2070	1250				
				Mercury	0.91	0.13				
				Silver	1.0 B	0.87				
				Zinc	129	126				
9/30/02	WS-71-B-009-6	A1423-08A	71 Area B	Antimony	9.2	6.8	X	X	X	BACKFILL
				Mercury	0.68	0.13				
9/30/02	WS-59-04-010-5	A1423-09A	59 Area 4	Mercury	0.42	0.13	X		X	BACKFILL
				Silver	2.1	0.87				
				Benzo(A) Pyrene	1.8	0.88				
9/30/02	WS-59-04-010-6	A1423-10A	59 Area 4	Mercury	0.95	0.13	X		X	BACKFILL
				Silver	2.6	0.87				
				Benzo(A) Pyrene	1.2	0.88				
9/30/02	WS-59-04-010-7	A1423-11A	59 Area 4	Mercury	0.51	0.13	X		X	BACKFILL
				Silver	2.1	0.87				
9/30/02	CL-71-E2-WW1	588950	NAP				X			NAP

**Table 1
SUMMARY TABLE**

Sample Date	Sample (pile) Identification	Laboratory ID	Area Removed From	Excedence Analyte	Observed Concentration, mg/kg	Cleanup Goal	Cleanup Goal Suite	TCLP	Waste Profile Suite	Final Disposition
9/30/02	CL-71-E2-WS1	588951	NAP	Benzo(A) Anthracene	9.1	8.8	X			NAP
				Benzo(A) Pyrene	6.1	0.88				
				Chrysene	8.8	2.3				
				Dibenzo(A,H) Anthracene	1.4 J	0.88				
9/30/02	CL-71-E2-WE1	588952	NAP	Benzo(A) Anthracene	9	8	X			NAP
				Benzo(A) Pyrene	8.8	0.88				
				Benzo(B) Fluoranthene	7.4	6.4				
				Benzo(K) Fluoranthene	8	6.4				
				Chrysene	10	2.3				
				Dibenzo(A,H) Anthracene	2	0.88				
9/30/02	CL-59-01-WS1	588953	NAP				X			NAP
9/30/02	FD-59-CL-05	588954	NAP				X			NAP
9/30/02	CL-59-01-F04	588955	NAP				X			NAP
9/30/02	CL-59-04-WS1	588956	NAP				X			NAP
10/1/02	WS-59-04-010-2	A1434-01A	59 Area 4	Copper	77.8	62.8	X		X	OFF SITE
				Mercury	1.2	0.13				
				Silver	8.3	0.87				
				Zinc	165	126				
10/1/02	WS-59-04-010-1	A1434-02A	59 Area 4	Mercury	0.23	0.13	X			BACKFILL
				Silver	2.3	0.87				
10/1/02	WS-59-04-010-3	A1434-03A	59 Area 4	Mercury	0.14	0.13	X			BACKFILL
				Silver	0.94	0.87				
10/1/02	WS-59-04-010-4	A1434-04A	59 Area 4	Mercury	0.27	0.13	X		X	BACKFILL
				Benzo(A) Pyrene	0.99	0.88				

**Table 1
SUMMARY TABLE**

Sample Date	Sample (pile) Identification	Laboratory ID	Area Removed From	Excedence Analyte	Observed Concentration, mg/kg	Cleanup Goal	Cleanup Goal Suite	TCLP	Waste Profile Suite	Final Disposition
10/1/02	WS-59-04-010-8	A1434-05A	59 Area 4	Mercury	0.52	0.13	X		X	STOCKPILE
				Silver	4.1	0.87				
10/1/02	WS-59-04-010-9	A1434-06A	59 Area 4	Mercury	0.4	0.13	X		X	BACKFILL
				Silver	1.9	0.87				
10/1/02	WS-59-04-010-11	A1434-07A	59 Area 4				X			BACKFILL
10/1/02	WS-59-04-010-10	A1434-08A	59 Area 4	Mercury	0.29	0.13	X			BACKFILL
				Silver	2.8	0.87				
10/1/02	FD-59-WS-05	A1434-09A	NAP				X			NAP
10/1/02	WS-59-01-011-1	A1434-10A	59 Area 1	Benzo(A) Pyrene	9.5	0.88	X		X	STOCKPILE
				Benzo(B) Fluoranthene	10	8.8				
				Chrysene	8	7.1				
				Dibenzo(A,H) Anthracene	1.6 J	0.88				
10/1/02	WS-59-01-011-2	A1434-11A	59 Area 1	Silver	0.93	0.87	X		X	STOCKPILE
				Benzo(A) Pyrene	7.4	0.88				
				Dibenzo(A,H) Anthracene	1.2 J	0.88				
10/1/02	WS-59-01-011-3	A1434-12A	59 Area 1	Benzo(A) Pyrene	3	0.88	X		X	BACKFILL
10/1/02	WS-59-01-011-4	A1434-13A	59 Area 1	Benzo(A) Pyrene	2.5	0.88	X		X	BACKFILL
10/3/02	WS-59-01-012-1	A1448-01A	59 Area 1	Silver	1.1 B	0.87	X		X	BACKFILL
				Benzo(A) Pyrene	2.1	0.88				
10/3/02	FD-59-WS-6	A1448-02A	NAP	Benzo(A) Pyrene	8.1 E	0.88	X		X	NAP
				Benzo(B) Fluoranthene	9.0 E	8.8				
				Dibenzo(A,H) Anthracene	1.1	0.88				
10/3/02	WS-59-01-012-2	A1448-03A	59 Area 1	Benzo(A) Pyrene	5.9 E	0.88	X		X	STOCKPILE

**Table 1
SUMMARY TABLE**

Sample Date	Sample (pile) Identification	Laboratory ID	Area Removed From	Excedence Analyte	Observed Concentration, mg/kg	Cleanup Goal	Cleanup Goal Suite	TCLP	Waste Profile Suite	Final Disposition
10/3/02	WS-59-01-014-1	A1448-04A	59 Area 1	Silver	0.96 B	0.87	X		X	BACKFILL
10/3/02	WS-59-01-014-2	A1448-05A	59 Area 1	Benzo(A) Pyrene	2.1	0.88	X		X	BACKFILL
10/3/02	WS-59-01-014-3	A1448-06A	59 Area 1	Silver	1.1 B	0.87	X		X	BACKFILL
10/3/02	WS-59-01-014-4	A1448-07A	59 Area 1	Silver	0.96 B	0.87	X		X	BACKFILL
				Benzo(A) Pyrene	0.89	0.88				
10/3/02	CL-59-01-WN3	A1448-10A	NAP	Chromium	33.6	32.7	X			NAP
				Cobalt	30.4	30				
				Copper	96.7	62.8				
				Silver	1.3 B	0.87				
				Zinc	233	126				
10/3/02	CL-59-01-WN4	A1448-11A	NAP	Silver	1.0 B	0.87	X			NAP
10/3/02	CL-59-01-WN5	A1448-12A	NAP	Silver	1.2 B	0.87	X			NAP
10/3/02	CL-59-01-WN6	A1448-13A	NAP				X			NAP
10/3/02	CL-59-01-WE1	A1448-14A	NAP	Silver	1.2 B	0.87	X			NAP
10/3/02	CL-59-01-WE2	A1448-15A	NAP	Silver	1.3 B	0.87	X			NAP
10/3/02	CL-59-01-F07	A1448-16A	NAP	Silver	1.0 B	0.87	X			NAP
10/3/02	CL-59-01-F06	A1448-17A	NAP	Silver	1.5 B	0.87	X			NAP
10/3/02	CL-59-01-F05	A1448-18A	NAP	Silver	1.2 B	0.87	X			NAP
10/3/02	WS-59-01-014-5	A1448-19A	59 Area 1				X			STOCKPILE
10/4/02	WS-59-01-015-1	590477	59 Area 1	Benzo(A) Pyrene	2.7	0.88	X		X	BACKFILL

**Table 1
SUMMARY TABLE**

Sample Date	Sample (pile) Identification	Laboratory ID	Area Removed From	Excedence Analyte	Observed Concentration, mg/kg	Cleanup Goal	Cleanup Goal Suite	TCLP	Waste Profile Suite	Final Disposition
10/4/02	WS-59-01-015-2	590478	59 Area 1	Benzo(A) Pyrene	2	0.88	X		X	BACKFILL
10/4/02	WS-59-01-015-3	590480	59 Area 1				X		X	STOCKPILE
10/4/02	WS-59-01-015-4	590481	59 Area 1	Benzo(A) Pyrene	6.2	0.88	X		X	STOCKPILE
				Dibenzo(A,H) Anthracene	1.3 J	0.88				
10/4/02	WS-59-01-015-5	590482	59 Area 1	Benzo(A) Pyrene	2.5	0.88	X		X	BACKFILL
10/4/02	WS-59-01-015-6	590484	59 Area 1	Benzo(A) Pyrene	2.9	0.88	X		X	BACKFILL
10/4/02	WS-59-01-015-7	590485	59 Area 1	Benzo(A) Pyrene	1.8 J	0.88	X		X	BACKFILL
10/4/02	WS-59-01-015-8	590487	59 Area 1	Benzo(A) Pyrene	4.2	0.88	X		X	STOCKPILE
10/4/02	WS-59-01-015-9	590488	59 Area 1	Benzo(A) Pyrene	2.4	0.88	X		X	BACKFILL
10/4/02	WS-59-01-015-10	590489	59 Area 1	Benzo(A) Pyrene	2	0.88	X		X	BACKFILL
10/4/02	WS-59-01-015-11	590490	59 Area 1	Antimony	11.1	6.8	X		X	BACKFILL
				Benzo(A) Pyrene	2.3	0.88				
10/7/02	WS-59-01-015-12	590823	59 Area 1	Mercury	7.7	0.13	X	X	X	OFF SITE
				Benzo(A) Pyrene	4.5	0.88				
				Dibenzo(A,H) Anthracene	0.97 J	0.88				
10/7/02	WS-59-01-015-13	590824	59 Area 1	Antimony	14.3	6.8	X		X	BACKFILL
				Zinc	137	126				
				Benzo(A) Pyrene	2.1	0.88				
10/7/02	FD-59-WS-07	590825	NAP	Zinc	145	126	X	X	X	NAP
				Benzo(A) Pyrene	14	0.88				
				Benzo(B) Fluoranthene	12	8.8				
				Benzo(K) Fluoranthene	13	19				
				Chrysene	16	7.1				

**Table 1
SUMMARY TABLE**

Sample Date	Sample (pile) Identification	Laboratory ID	Area Removed From	Excedence Analyte	Observed Concentration, mg/kg	Cleanup Goal	Cleanup Goal Suite	TCLP	Waste Profile Suite	Final Disposition
				Dibenzo(A,H) Anthracene	2.9 J	0.88				
10/7/02	WS-59-01-015-14	590826	59 Area 1	Antimony	43.9	6.8	X	X	X	STOCKPILE
				Zinc	126	126				
				Benzo(A) Pyrene	4.8	0.88				
				Dibenzo(A,H) Anthracene	0.88 J	0.88				
10/7/02	WS-59-01-015-15	590827	59 Area 1	Benzo(A) Pyrene	4.3	0.88	X		X	STOCKPILE
10/7/02	WS-71-C-009-4	590828	71 Area C	Antimony	110	6.8	X	X	X	OFF SITE
				Barium	410	300				
				Copper	578	62.8				
				Lead	6410	1250				
				Mercury	10.6	0.13				
				Zinc	126	126				
				Benzo(A) Anthracene	12	8.8				
				Benzo(A) Pyrene	11	0.88				
				Benzo(B) Fluoranthene	8.5	6.4				
				Benzo(K) Fluoranthene	9.4	6.4				
				Chrysene	12	2.3				
				Dibenzo(A,H) Anthracene	2	0.88				
10/7/02	WS-71-C-009-5	590829	71 Area C	Antimony	19	6.8	X	X	X	OFF SITE
				Copper	221	62.8				
				Lead	1310	1250				
				Mercury	2.8	0.13				
				Zinc	148	126				
10/7/02	WS-59-01-012-3	590830	59 Area 1	Benzo(A) Anthracene	10	8.8	X		X	STOCKPILE
				Benzo(A) Pyrene	16	0.88				
				Benzo(B) Fluoranthene	11	8.8				
				Chrysene	11	7.1				
				Dibenzo(A,H) Anthracene	2.9	0.88				
10/7/02	WS-59-01-011-9	590831	59 Area 1	Benzo(A) Pyrene	9.9	0.88	X		X	STOCKPILE

**Table 1
SUMMARY TABLE**

Sample Date	Sample (pile) Identification	Laboratory ID	Area Removed From	Excedence Analyte	Observed Concentration, mg/kg	Cleanup Goal	Cleanup Goal Suite	TCLP	Waste Profile Suite	Final Disposition
				Chrysene	7.7	7.1				
				Dibenzo(A,H) Anthracene	1.9 J	0.88				
10/7/02	WS-59-01-011-7	590832	59 Area 1	Benzo(A) Anthracene	14	8.8	X	X	X	STOCKPILE
				Benzo(A) Pyrene	16	0.88				
				Benzo(B) Fluoranthene	11	8.8				
				Benzo(K) Fluoranthene	13	19				
				Chrysene	13	7.1				
				Dibenzo(A,H) Anthracene	2.8 J	0.88				
10/7/02	WS-59-01-011-8	590833	59 Area 1	Benzo(A) Anthracene	12	8.8	X		X	STOCKPILE
				Benzo(A) Pyrene	15	0.88				
				Benzo(B) Fluoranthene	11	8.8				
				Benzo(K) Fluoranthene	11	19				
				Chrysene	12	7.1				
				Dibenzo(A,H) Anthracene	2.6	0.88				
10/7/02	WS-59-01-011-6	590834	59 Area 1	Benzo(A) Pyrene	6.3	0.88	X		X	STOCKPILE
				Dibenzo(A,H) Anthracene	1.1 J	0.88				
10/7/02	WS-59-01-011-5	590835	59 Area 1	Antimony	15.7	6.8	X		X	STOCKPILE
10/8/02	WS-59-01-013-1	591333	59 Area 1	Benzo(A) Pyrene	7	0.88	X		X	BACKFILL
				Chrysene	7.5	7.1				
				Dibenzo(A,H) Anthracene	1.4 J	0.88				
10/8/02	WS-59-01-013-2	591334	59 Area 1	Benzo(A) Pyrene	5.1	0.88	X		X	STOCKPILE
				Dibenzo(A,H) Anthracene	1.1 J	0.88				
10/8/02	WS-59-01-013-3	591335	59 Area 1	Benzo(A) Pyrene	2.9	0.88	X		X	BACKFILL
10/8/02	WS-59-01-013-4	591336	59 Area 1	Benzo(A) Pyrene	1.4	0.88	X		X	BACKFILL
10/8/02	WS-59-01-013-5	591337	59 Area 1	Copper	305	62.8	X	X	X	BACKFILL
				Benzo(A) Pyrene	2	0.88				

**Table 1
SUMMARY TABLE**

Sample Date	Sample (pile) Identification	Laboratory ID	Area Removed From	Excedence Analyte	Observed Concentration, mg/kg	Cleanup Goal	Cleanup Goal Suite	TCLP	Waste Profile Suite	Final Disposition
10/8/02	WS-59-01-013-6	591338	59 Area 1	Benzo(A) Pyrene	2.7	0.88	X		X	BACKFILL
10/8/02	WS-59-01-015-16	591339	59 Area 1	Antimony	12	6.8	X	X	X	STOCKPILE
				Benzo(A) Pyrene	4	0.88				
10/8/02	WS-59-01-015-17	591340	59 Area 1	Benzo(A) Pyrene	5.4	0.88	X		X	STOCKPILE
				Dibenzo(A,H) Anthracene	0.89 J	0.88				
10/8/02	WS-59-01-013-7	591341	59 Area 1	Benzo(A) Pyrene	1.4	0.88	X		X	BACKFILL
10/8/02	WS-59-01-015-19	591342	59 Area 1	Benzo(A) Pyrene	3.8	0.88	X	X	X	BACKFILL
10/8/02	WS-59-01-015-18	591343	59 Area 1	Antimony	7.9	6.8	X		X	BACKFILL
				Benzo(A) Pyrene	3.6	0.88				
10/8/02	WS-59-01-015-20	591344	59 Area 1	Benzo(A) Pyrene	5.9	0.88	X		X	STOCKPILE
				Dibenzo(A,H) Anthracene	1.0 J	0.88				
10/8/02	CL-59-01-F03	A1469-01A	NAP	Silver	1.0 B	0.87	X			NAP
				Acetone	0.22	0.2				
10/8/02	CL-59-01-WE4	A1469-03A	NAP	Acetone	0.68 E	0.2	X			NAP
10/8/02	CL-59-01-F08	A1469-04A	NAP				X			NAP
10/8/02	CL-59-01-F09	A1469-05A	NAP	Dibenzo(A,H) Anthracene	1.0 J	0.88	X			NAP
10/8/02	CL-59-01-F10	A1469-06A	NAP				X			NAP
10/8/02	FD-59-CL-06	A1469-07A	NAP				X			NAP
10/8/02	CL-59-01-F11	A1469-08A	NAP				X			NAP
10/8/02	CL-59-01-F13	A1469-09A	NAP				X			NAP

**Table 1
SUMMARY TABLE**

Sample Date	Sample (pile) Identification	Laboratory ID	Area Removed From	Excedence Analyte	Observed Concentration, mg/kg	Cleanup Goal	Cleanup Goal Suite	TCLP	Waste Profile Suite	Final Disposition
10/8/02	CL-59-01-F14	A1469-10A	NAP				X			NAP
10/8/02	CL-59-01-F15	A1469-11A	NAP				X			NAP
10/9/02	CL-59-01-F12	A1480-01A	NAP	Sodium	1800	269	X			NAP
10/9/02	CL-59-01-F16	A1480-02A	NAP				X			NAP
10/9/02	CL-59-01-WE5	A1480-03A	NAP	Sodium	4060	269	X			NAP
10/9/02	CL-59-01-F17	A1480-04A	NAP	Sodium	808	269	X			NAP
10/9/02	CL-59-01-WS2	A1480-05A	NAP				X			NAP
10/9/02	CL-59-01-F18	A1480-06A	NAP	Sodium	899	269	X			NAP
10/9/02	CL-59-01-WS3	A1480-07A	NAP	Sodium	418	269	X			NAP
10/9/02	CL-59-01-F19	A1480-08A	NAP	Sodium	3010	269	X			NAP
10/9/02	CL-59-01-F20	A1480-09A	NAP	Sodium	2380	269	X			NAP
10/9/02	CL-59-01-WS6	A1480-10A	NAP	Sodium	2230	269	X			NAP
10/9/02	CL-59-01-WS4	A1480-11A	NAP	Sodium	1480	269	X			NAP
10/9/02	CL-59-01-WS5	A1480-12A	NAP	Sodium	956	269	X			NAP
10/9/02	WS-59-01-016-1	591753	59 Area 1	Benzo(A) Pyrene Chrysene	7.6 9	0.88 7.1	X		X	STOCKPILE
10/9/02	WS-59-01-016-2	591754	59 Area 1	Benzo(A) Pyrene	4.6	0.88	X		X	STOCKPILE

**Table 1
SUMMARY TABLE**

Sample Date	Sample (pile) Identification	Laboratory ID	Area Removed From	Excedence Analyte	Observed Concentration, mg/kg	Cleanup Goal	Cleanup Goal Suite	TCLP	Waste Profile Suite	Final Disposition
10/9/02	WS-59-01-016-3	591755	59 Area 1	Sodium	312	269	X		X	STOCKPILE
				Benzo(A) Pyrene	2.9	0.88				
10/9/02	WS-59-01-016-4	591756	59 Area 1	Sodium	525	269	X		X	STOCKPILE
10/9/02	WS-59-01-016-5	591757	59 Area 1	Benzo(A) Pyrene	4.4	0.88	X		X	STOCKPILE
10/9/02	WS-59-01-016-6	591758	59 Area 1	Benzo(A) Pyrene	4.7	0.88	X		X	STOCKPILE
10/9/02	WS-59-01-016-7	591759	59 Area 1	Sodium	819	269	X		X	BACKFILL
10/9/02	WS-59-01-016-8	591760	59 Area 1	Sodium	548	269	X		X	BACKFILL
10/9/02	WS-59-01-016-9	591761	59 Area 1	Mercury	0.14	0.13	X		X	STOCKPILE
				Benzo(A) Pyrene	7.6	0.88				
				Chrysene	9	7.1				
10/9/02	WS-59-01-016-10	591762	59 Area 1	Lead	1440	400	X	X	X	STOCKPILE
				Mercury	0.27	0.13				
				Sodium	330	269				
				Benzo(A) Pyrene	3.6	0.88				
10/9/02	WS-59-01-016-11	591763	59 Area 1	Sodium	435	269	X		X	BACKFILL
10/9/02	WS-59-01-016-12	591764	59 Area 1	Sodium	644	269	X		X	BACKFILL
10/10/02	CL-59-01-F21	A1488-01A	NAP				X			NAP
10/10/02	CL-59-01-F22	A1488-02A	NAP	Sodium	1200	269	X			NAP
10/10/02	CL-59-01-F23	A1488-03A	NAP	Sodium	365	269	X			NAP
10/10/02	CL-59-01-F24	A1488-04A	NAO	Sodium	463	269	X			NAP

**Table 1
SUMMARY TABLE**

Sample Date	Sample (pile) Identification	Laboratory ID	Area Removed From	Excedence Analyte	Observed Concentration, mg/kg	Cleanup Goal	Cleanup Goal Suite	TCLP	Waste Profile Suite	Final Disposition
10/10/02	CL-59-01-F25	A1488-05A	NAP				X			NAP
10/10/02	CL-59-01-F26	A1488-06A	NAP				X			NAP
10/10/02	WS-59-01-018-7	A1488-09A	59 Area 1	Sodium	991	269	X			BACKFILL
10/10/02	WS-59-01-018-8	A1488-08A	59 Area 1	Sodium	672	269	X			BACKFILL
10/10/02	WS-59-01-016-13	592314	59 Area 1	Mercury	0.15	0.13	X		X	STOCKPILE
				Benzo(A) Pyrene	3.7	0.88				
10/10/02	WS-59-01-016-14	592315	59 Area 1	Benzo(A) Pyrene	7.3	0.88	X	X	X	STOCKPILE
				Dibenzo(A,H) Anthracene	1.3	0.88				
10/10/02	WS-59-01-016-15	592316	59 Area 1	Sodium	414	269	X		X	BACKFILL
10/10/02	FD-59-WS-8	592317	NAP	Benzo(A) Pyrene	2.6	0.88	X		X	NAP
10/10/02	WS-59-01-016-16	592318	59 Area 1	Sodium	546	269	X		X	BACKFILL
10/10/02	WS-59-01-016-17	592319	59 Area 1	Benzo(A) Pyrene	3.6	0.88	X		X	BACKFILL
10/10/02	WS-59-01-016-18	592320	59 Area 1	Chromium	35	32.7	X	X	X	STOCKPILE
				Lead	129	400				
				Mercury	0.51	0.13				
				Silver	4.7	0.87				
				Sodium	398	269				
				Zinc	157	126				
10/10/02	WS-59-01-016-19	592321	59 Area 1	Mercury	0.29	0.13	X		X	STOCKPILE
				Silver	1.2	0.87				
				Sodium	455	269				
10/10/02	WS-59-01-016-20	592322	59 Area 1	Mercury	0.28	0.13	X		X	STOCKPILE
				Benzo(A) Pyrene	8.5	0.88				

**Table 1
SUMMARY TABLE**

Sample Date	Sample (pile) Identification	Laboratory ID	Area Removed From	Excedence Analyte	Observed Concentration, mg/kg	Cleanup Goal	Cleanup Goal Suite	TCLP	Waste Profile Suite	Final Disposition
				Chrysene	7.5	7.1				
10/10/02	WS-59-01-017-1	592323	59 Area 1				X		X	BACKFILL
10/10/02	WS-59-01-017-2	592324	59 Area 1	Mercury- Benzo(A) Pyrene	0.21 2.1	0.13 0.88	X		X	BACKFILL
10/11/02	WS-59-01-018-1	592792	59 Area 1	Sodium Benzo(A) Pyrene	270 2.8	269 0.88	X		X	BACKFILL
10/11/02	WS-59-01-018-3	592793	59 Area 1	Sodium	1150	269	X		X	BACKFILL
10/11/02	WS-59-01-018-5	592794	59 Area 1	Sodium	833	269	X		X	BACKFILL
10/11/02	WS-59-01-018-2	592795	59 Area 1	Sodium Benzo(A) Pyrene	860 1.5	269 0.88	X		X	BACKFILL
10/11/02	WS-59-01-018-4	592796	59 Area 1	Sodium	1620	269	X		X	BACKFILL
10/11/02	WS-59-01-018-6	592797	59 Area 1	Sodium Benzo(A) Pyrene	1140 1.4 J	269 0.88	X		X	BACKFILL
10/11/02	WS-71-E3-009-10	592798	71 Area E3				X		X	BACKFILL
10/11/02	CL-71-E3-WN1	592799	NAP				X			NAP
10/11/02	CL-71-E3-WE1	592800	NAP				X			NAP
10/11/02	CL-71-E3-F01	592801	NAP				X			NAP
10/11/02	CL-71-E3-WS1	592802	NAP				X			NAP
10/11/02	CL-71-E3-VW1	592803	NAP				X			NAP
10/14/02	WS-71-D-009-11	593272	71 Area D				X	X	X	OFF SITE

**Table 1
SUMMARY TABLE**

Sample Date	Sample (pile) Identification	Laboratory ID	Area Removed From	Excedence Analyte	Observed Concentration, mg/kg	Cleanup Goal	Cleanup Goal Suite	TCLP	Waste Profile Suite	Final Disposition
10/14/02	WS-71-B-009-12	593273	71 Area B	Lead	1460	400	X	X	X	OFF SITE
				Barium						
				Zinc	146	126				
10/14/02	FD-71-WS-08	593274	NAP	Copper	65.5	62.8	X	X	X	NAP
10/14/02	MC-59-01-01	593326	59 Area 1					X	X	OFF SITE
	MC-59-01-02	593327	59 Area 1					X	X	OFF SITE
	MC-59-03-02	593328	59 Area 3					X	X	OFF SITE
	FD-59-MC-01	593329	NAP					X	X	OFF SITE
	MC-59-03-01	593330	59 Area 3					X	X	OFF SITE
	MC-59-01-01	593332	59 Area 1					X	X	OFF SITE
	MC-59-01-02	593333	59 Area 1					X	X	OFF SITE
	MC-59-03-02	593334	59 Area 3					X	X	OFF SITE
	MC-59-03-01	593336	59 Area 3					X	X	OFF SITE
10/22/02	MC-59-01-02-2	595521	59 Area 2					X	X	OFF SITE
	CL-71-D-VW2	595522	NAP	Antimony	43.9	6.8	X			NAP
				Copper	126	62.8				
				Lead	5320	1250				
				Mercury	0.2	0.13				
				Zinc	187	126				
11/1/02	WS-71-D-090-13	598483	71 Area D				X			BACKFILL

Appendix L

Response to Comments

Army's Response to Comments from the US Environmental Protection Agency

Subject: Draft Phase II Remedial Investigation Report for SEAD-59 & SEAD-71
Seneca Army Depot
Romulus, New York

Comments Dated: November 16, 2005

Date of Comment Response: January 5, 2006 (Revised 4/13/06)

Army's Response to Comments

GENERAL COMMENTS

Comment 1: Throughout the subject document, reference is made to a 2002 Time Critical Removal Action Report by ENSR (2002 a, b). EPA does not have copies of the referenced report, and requests the report to be submitted to the regulatory agencies for review.

Response 1: Acknowledged. The Army has submitted the following two ENSR reports to USEPA and NYSDEC.

- ENSR. 2002a. Final Draft Removal Report, SEAD-59 and 71 Time Critical Removal Action. December.
- ENSR. 2002b. Final Work Plan, SEAD-59 and 71 Time Critical Removal Action. August.

Comment 2: The document does not contain any references to the depths of the monitoring wells sampled. This information should be included for completeness.

Response 2: Agreed. Information regarding the depths of the monitoring wells has been added to the monitoring well summary tables (Tables 1-1 and 1-2 in the Draft Final report).

Comment 3: The following general comments pertain to site conditions within the Fenced Area of SEAD-71:

- High levels of PAHs were observed in seven surface soil samples within the Fenced Area of SEAD-71. The document attributes these PAHs to the presence of asphalt. This is one plausible explanation, but that railroad tracks are depicted running throughout this area and various types of equipment were stored within the Fenced Area, are certainly other potential explanations. If the PAH data in soil is biased high due to the presence of surficial asphalt, then a more appropriate

way to gauge risks posed by contamination within the Fenced Area would be to collect additional, representative, surficial soil samples for PAH analysis.

- Exclusion of the soil data within the Fenced Area from the risk assessments presented in this document is not suitably conservative. A more conservative approach would be to consider the Fenced Area a separate exposure point within SEAD-71, and to present the risks associated with it separately, rather than discounting them because the presence of asphalt in some parts of this area.
- The text of the document refers to the high lead level of 3,470 milligrams per kilogram (mg/kg) present in one surface soil sample collected within the Fenced Area at SEAD-71 as an anomaly. No justification, statistical or other, is provided for this claim. The high lead level may be caused by historical disposal of lead-based paint at the site or because of railroad operations at the site, presumably dating to the Depot opening in 1941. This lead level is effectively double the upper end of the range of 750-1,750 mg/kg recommended by the USEPA for industrial areas in the 1996 publication entitled, Recommendations of the Technical Review Workgroup for Lead for an Interim Approach to Assessing Risks Associated with Adult Exposures to Lead in Soil.

Institutional Controls (ICs) are planned for the area encompassing both of these sites to limit exposure to site soil and groundwater. For the Fenced Area, the IC is simply to maintain the fence and perform a five-year review. This approach is not justified. The Fenced Area should be targeted specifically in the Record of Decision (ROD) to prevent exposure to the PAHs and lead in surface soils in this area of SEAD-71. Other response actions should be considered, either a limited removal action or a cap, such as repaving the area, which is described as generally paved over or covered with crushed stone or pieces of asphalt or concrete, or other means to limit direct contact.

Response 3: The responses to the above comments are presented correspondingly below.

- Acknowledged. The sections that provided explanation of the elevated PAHs within the Fenced Area at SEAD-71 (e.g., Section 4.4.1.2, Section 6.9.3.1, and Section 8.1.3) have been revised based on additional information provided by the Army on the original construction methods for this area. At the time of construction, the Army typically utilized hard fill consisting of oiled crushed stone and asphalt to form a sturdy base for areas subjected to heavy vehicular traffic and storage operations. The oil was used to help in the compaction of the crushed stone and aided in stability of the surface. The hard fill prevented operations from being impacted by muddy and unstable soils and it was placed throughout the SEAD-71 Fenced Area. The presence of asphalt is noted in the boring log of MW71-1 presented in the ESI report (Parsons, 1996) and field notes recorded while surface soil samples were collected within the Fenced Area. The crushed asphalt

materials in the hard fill and the oil used in the construction of the storage area are likely the cause of the consistently elevated PAH concentrations throughout the Fenced Area.

There is no value in collecting additional samples of the surficial hard fill material since the results will be consistent with previous sampling results and will only serve to delay the approval of the RI Report.

- Acknowledged. A risk assessment has been conducted for SEAD-71 using the whole site including the Fenced Area as an exposure point and the results are presented in the report. The total cancer risk for the industrial worker is above the USEPA upper target limit of 1×10^{-4} . Although a risk assessment can be performed by using the Fenced Area as a separate exposure point, this extra effort would not change the overall conclusion that there is unacceptable risk to human health via exposure to PAHs in the Fenced Area. Therefore, additional risk assessment is not deemed necessary.
- The elevated lead hit is the only sample that exceeded the screening level for industrial scenario (1250 mg/kg) at SEAD-59/71. The next highest concentration within the Fenced Area at SEAD-71 was 572 mg/kg at SS71-19. The average lead concentration within the Fenced Area was 350 mg/kg, which was lower than the USEPA (1998) recommended 400 mg/kg screening level for lead in soil at residential properties. The Army maintains that the lead hit is isolated and the average lead concentration within the Fenced Area is well within the acceptable range.
- The Army believes that its approach of land use controls is appropriate for the Fenced Area. The PAHs in the Fenced Area are likely due to the crushed asphalt materials in the hard fill and the oil used in the construction of the storage area. A limited removal action is not feasible since the entire area is covered with the stabilized asphalt surface.

SPECIFIC COMMENTS

Comment 1: Page 1-5, Section 1.4.1, Regional Geology, 3rd Paragraph. Regional background concentrations for inorganic compounds as presented in Table 1-1 are referenced here. Since a background study for inorganic compounds in Seneca Army Depot Activity soils has been conducted, this information is not relevant. Text should be revised.

Response 1: Agreed. Section 1.4.1 has been revised to remove the entire discussion on the regional background concentrations. Table 1-1 has been removed from the report and all tables in Section 1 have been renumbered accordingly.

Comment 2: Page 4-1, Section 4.1, ARARs and TBCs, 4th Paragraph. The text mentions that comparisons that are made in the document between the Benzo(a)pyrene Toxicity Equivalents (BTEs) calculated for carcinogenic PAHs at SEADs 59 and 71 and a value suggested as a clean-up level by the New York State Department of Environmental Conservation in their comments on an Action Memorandum for SEAD-11, dated January 26, 2004. Further justification should be provided in the text as to why this BTE value is appropriate to use at these sites.

Response 2: Acknowledged. The 10 mg/kg level of total BTE for carcinogenic PAHs was only used for screening purposes. It was not identified as an ARAR or a TBC, nor was it used as a cleanup goal or to replace risk assessment. The risk assessment conducted for the sites demonstrated that carcinogenic PAHs with a 10 mg/kg BTE level would not pose unacceptable risk to the potential receptors at the sites. The above discussion has been added to Section 4.1 for clarification.

Comment 3: Page 5-7, Section 5.4, SEAD-59 and SEAD-71 Contaminant Fate and Transport, 2nd Paragraph, 2nd Sentence. The text states that “groundwater appears to be unaffected by VOCs, SVOCs, pesticides, or PCBs.” This statement implies that these compounds were not detected in any samples collected at the two sites, which is not true according to the data tables provided in Appendix A. Revise accordingly.

Response 3: Agreed. Section 5.4 has been revised to read “VOC, SVOC, pesticide, and PCB groundwater standards/guidance values were not exceeded in any sample with the exception of 4-nitroaniline (8.7 ug/L vs. 5.0 ug/L guidance value). A total of seven analytes (toluene, 4,4'-DDE, 4,4'-DDT, 1,1,1-trichloroethane, di-n-butylphthalate, bis(2-ethylhexyl)phthalate, and 4-nitroaniline) were detected. However, the concentrations were below the NYSDEC Class GA groundwater standards or guidance values.

Comment 4: Page 5-7, Section 5.4, SEAD-59 and SEAD-71 Contaminant Fate and Transport, Various Sections on Fate and Transport Mechanisms for Specific Classes of Compounds. Extensive information is presented on the fate and transport mechanisms for VOCs, SVOCs, pesticides, PCBs, and metals. The discussions of bioavailability cite studies performed on various organisms to provide evidence of bioavailability. This information is useful, but references to bioavailability studies should be limited to those performed on biota residing in the vicinity of these sites. For example, it is unlikely that any shellfish will be impacted by site contamination, as discussed in the last paragraph on page 5-12. Exceptions could be made for organisms that could potentially be preyed upon by the species likely to be present in the site area.

Response 4: Agreed. Section 5.4 has been revised to limit references to bioavailability studies of site related biota.

Comment 5: Page 6-4, last paragraph. In this paragraph it is indicated that volatilization of metals from soil is not considered a realistic mechanism for pollutant migration. While generally true, there are some metals, such as mercury, that can volatilize and migrate through into air. Suggest changing the sentence to say "For example, generally volatilization of metals from soil..." In addition, rationale is provided that indicates that leaching is a potential mechanism for metal transport, but it does not mention if the metals detected at the site were looked at from a leaching perspective (i.e., TLP analysis). Please include this information if the TLP analysis was conducted.

Response 5: Agreed. The suggested wording has been used in the document for volatilization. TCLP analysis was conducted for several samples collected during the 2002 TCRA. The results have been added to Appendix A and discussion of the Toxicity Characteristic Leaching Procedure (TCLP) results has been added to Section 6.2.2 and Section 5.4.1.

Comment 6: Page 6-12, Section 6.4, number 1 and 3. It is indicated that the maximum detected concentrations were screened against the USEPA Region IX PRGs that correspond to a hazard quotient of 1. Region 2 screens against the USEPA Region IX PRGs that correspond to a hazard quotient of 0.1. Also, in number 1, please rephrase the statement that indicates that chemicals were eliminated if there were no screening values. The appropriate method to follow is that if a chemical does not have a screening value then it should be retained and addressed qualitatively in the uncertainty section (i.e., by indicating that the risks and hazards may be underestimated). Please remove the reference to using USEPA MCLs for screening purposes in number 3 as all of the chemicals that have MCLs have screening values presented in the Region IX PRG table.

Response 6: Acknowledged. The rationale for using USEPA Region IX PRGs that correspond to a hazard quotient of 1 is presented below. Inclusion of chemicals without toxicity values in the risk assessment would not change the overall risk assessment results. The risk assessment has not been revised to include these analytes. Uncertainty associated with chemicals without available toxicity values was presented in Section 6.8.3. Since the Region IX PRG table does not provide a screening value for lead, the USEPA MCL for lead was used for screening purposes. The reference to the USEPA MCLs was retained in the section.

The Army's screening process is consistent with the previous guidance that was provided by the EPA Region II. On August 25, 2004, the EPA Region II commented on the Final Decision Document for SEAD-13 and recommended "to first screen all compounds that were detected using the Region IX PRGs and then employ the use of frequency of detection procedure to further eliminate any compounds that are infrequently detected." Adjustment of the Region IX PRGs was not mentioned in the SEAD-13 comment letter.

Further, in a memo issued by Chuck Nace of USEPA, Region II, dated November 8, 2004, related to human health risk assessment at SEAD-13, the USEPA Region II specified that "the standard procedure for choosing chemicals of potential concern are to screen the maximum detected concentration against health-based screening values (i.e., USEPA Region IX Preliminary Remediation Goals) and retain those compounds that exceed their respective screening values." Again, no mention has been made of adjusting the PRGs.

In response to these guidance statements, the Army submitted a response to the SEAD-13 comments and a risk assessment technical memorandum in a letter dated February 15, 2005. The response letter and the memorandum presented methodology and results of a revised risk assessment based on a screening conducted by using the unadjusted Region IX PRGs. EPA Region II accepted the revised risk assessment on March 30, 2005.

It should further be noted that the COPC screening for human health risk assessment was conducted using a very conservative approach. The USEPA Region IX PRGs for residential soil and tap water were used to compare with the maximum detected concentrations at the sites. Since the planned future land use for SEAD-59 and SEAD-71 is industrial development, using the residential PRGs provides a very conservative approach for COPC screening. Therefore, revising the COPC screening would not change the overall risk assessment results and conclusion.

In summary, the COPC screening was conducted using a very conservative approach and was consistent with the previous EPA recommendations. Therefore, revision of the COPC screening process is not expected to change the overall risk assessment results and conclusions and is not deemed necessary.

Please refer to response to EPA comment #1 dated 2/15/06 (via email) for additional response.

Comment 7: Page 6-12, last paragraph. Please clarify what the stock piled soil represents. It appears to be excavated soil that has remained on site after the time-critical removal action. It is not clear why soil that was removed as part of a time-critical removal action, and presumably contaminated above removal criteria, would be retained on-site and then re-assessed to determine if it should be removed.

Response 7: Acknowledged. Soil that was removed as part of the TCRA was placed in 150cy piles, sampled, and analyzed for VOCs, SVOCs, pesticides, and metals. As presented in the Final Action Memorandum for Removal Actions at SWMUs SEAD-59 and SEAD-71, "Soils with concentrations of VOCs, SVOCs, pesticides, and metals exceeding the cleanup goals will be disposed offsite... Excavated soil that is not found to contain concentrations of contaminants in excess of NYSDEC TAGM 4046 criteria will be used as backfill". The remaining stockpiles are excavated soil that has contaminant concentrations that are generally consistent with the cleanup goals. Since all cleanup goals were not met for each stockpile sample, the Army believed that the best approach was to evaluate the sample results

through risk assessment to determine if the stockpiles represented unacceptable risk. The risk assessment was conducted as part of this RI and it has been determined that the stockpiles do not represent unacceptable risk and can be used as site fill.

Please refer to response to EPA comment #2 dated 2/15/06 (via email) for additional response.

Comment 8: Page 6-16, third paragraph. Suggest changing “blow” to “below”.

Response 8: The paragraph has been revised to correct the spelling.

Comment 9: Page 6-16, last paragraph. Please provide a rationale for the number of days per year that was used for the child trespasser and the age of the child trespasser. It is likely that a true trespasser would have a greater exposure frequency and it is unlikely that a child aged 0-6 would represent a true trespasser on the site. Typically trespassers are considered to be adolescents in the age bracket of >6-18 years of age and this age group has many days in the summer months to roam without parental oversight. A trespasser that falls within the age bracket just mentioned was used for SEAD-121C and SEAD-121I, which are located near SEAD-59 and SEAD-71 and a similar assessment should be done for these SEADs.

Response 9: Acknowledged. USEPA guidance documents on conducting human health risk assessments do not recommend a value for the exposure for a trespasser. The 14 day period was selected based on best professional judgment and by evaluating site-specific conditions. The Depot is fenced to limit access and is occasionally patrolled by site security personnel. Therefore, it is unlikely for anybody to trespass. Further, the Depot is over 10,600 acres in size and SEAD-59/71 (approximately 6 acres in total) constitutes a tiny fraction of the Depot. Therefore, trespassing at SEAD-59/71 is considered unlikely. Nonetheless, a trespasser receptor was selected as a conservative step to evaluate potential risk associated with exposure to the site contaminants and 14 day exposure is considered a reasonable assumption for the sites.

The Army agrees that adolescents (versus 0-6 yr children) are likely to be typical trespassers. Since 0-6 yr children are considered sensitive populations to potential environmental risks compared with adolescents (e.g., an 11-16 yr old used for SEAD-121C/121I), it is a conservative step to evaluate potential risks to trespassers by using a child receptor. Evaluating risks to an adolescent trespasser will not change the conclusion of the risk assessment since there is no significant risk to potential trespassers. Therefore, the Army proposes to use 0-6 yr trespassers as a surrogate for adolescent trespassers. Section 6.2.4.3 has been revised to reflect that the child trespasser receptor will be used as a surrogate for adolescent trespassers.

Please refer to response to EPA comment #3 dated 2/15/06 (via email) for additional response.

Comment 10: Page 6-21, Section 6.5.3.2. The use of relative bioavailability in the ingestion of soil calculations has not been used in similar evaluations (see SEAD-121C and SEAD-121I) where PAHs were potential contaminants of concern. Given that there are no relative bioavailability values for other contaminants and the suggested value is based upon one evaluation that is almost ten years old, and not typically used, the relative bioavailability term should be removed from the formula. The reference should also be removed from page 6-35 in the last paragraph and elsewhere in the document. In addition, the risk estimates will need to be recalculated.

Response 10: Disagreed. The bioavailability of PAHs for soil ingestion exposure is from a peer-reviewed paper by Magee et al. (1996). The bioavailability value presented in the paper was estimate of multiple available studies and has been adopted by states such as Massachusetts. The use of relative bioavailability in general is consistent with the USEPA guidance. As an example, an oral bioavailability of 0.6 is used by USEPA for lead models. In addition, the bioavailability was based on multiple available studies and has been through peer reviews. Therefore, the use of PAH bioavailability for soil ingestion is expected to produce reasonable risk estimates. Nonetheless, to address the above comments, a discussion of the uncertainty associated with using the relative bioavailability value for PAHs has been included in Section 6.8.2. An Appendix I has been added to the report to present risk results when default relative bioavailability value of 1 were used for all COPCs. As shown in Section 6.8.2 and Appendix G, using bioavailability of 1 for all COPCs would not change the overall risk characterization conclusion.

Although the oral relative bioavailability used in this risk assessment is deemed a reasonable estimate, it is not the Army's intention to use this bioavailability on all sites at Seneca. PAH concentrations at SEAD-121C and SEAD-121I are relatively low compared with SEAD-71 PAH concentrations and therefore a default oral relative bioavailability value of 1 was sufficient to demonstrate no significant risk via exposure to PAHs.

Please refer to response to EPA comment #4 dated 2/15/06 (via email) for additional response.

Comment 11: Page 6-26, first paragraph. Please explain what is meant by "Therefore, the model was used only as a screening tool for construction workers at the sites." The adult lead model does not provide guidance on using the model as a quantitative estimate for some populations and for screening purpose for other populations.

Response 11: Acknowledged. Section 6.5.3.6 and other related sections have been revised to reflect that the ALM model was used to characterize potential risks via exposure to lead for construction workers at the sites.

Comment 12: Page 6-33, SEAD-71, first paragraph. It is indicated that the adult lead model is based on the assumption of continuing long-term exposure, however as stated, the adult lead model protects the

developing fetus. As the fetus is the most sensitive receptor, which is at most 10 months of age prior to birth, the short-term exposure to a construction worker is appropriate and should be evaluated in similar terms as people that have longer term exposures. This should be changed in this section and in other places in the document, such as on page 6-36 and 6-38.

Response 12: Agreed. Sections 6.7.4.4, 6.8.2, 6.9.3, and other related sections have been revised to incorporate the above comment.

Comment 13: Page 6-37, Section 6.8.4. Suggest changing the last sentence to read "On the other hand, the assumption of additivity does not allow for potential synergistic or antagonistic effects of various chemicals, which may result in an underestimation or overestimation of risk, respectively."

Response 13: Agreed. The text in Section 6.8.4 has been changed as suggested above.

Comment 14: Page 39, Section 6.9.3.1. This section explains potential sources of the PAHs that were detected in the soil. Although the asphalt at the site may contribute to the PAHs detected at the site, there may be other potential sources, such as storage of equipment, runoff from the adjacent railroad, and atmospheric deposition. In order to better characterize the source, it would be beneficial to provide documented evidence that the type of PAHs, as well as the ratios observed, are similar to the hypothesized source(s). In addition, comparison to background levels, again by type and ratio of PAHs, observed in soils from other areas that are not impacted by site-related PAHs or asphalt would enhance this discussion. As it is currently presented, it is something to consider, but it is not a "fact" as described on page 6-40 in the third paragraph.

Response 14: The Army agrees that there may be other sources, such as roadway runoff, leaching from railroad ties and dripping from railroad equipment contributing to the identified PAH levels detected at the site. However, the main sources of PAHs are likely the crushed asphalt materials in the hard fill and the oil used in the construction of the storage area as discussed in General Comment No. 3. The Army's intent in mentioning asphalt and hard fill at the site was not meant to limit the possible number of sources, but to use knowledge of the site to tag some that are most likely. Although the suggested information may enhance the discussion, it is not the Army's place or intention to mount a research study to obtain the information and the information would not be conclusive or useful in determining a path forward for the site. Further, and more importantly, all contaminants identified at the site have been documented, and their potential for contributing to the risk posed at the site has been enumerated. The discussion in Section 6.9.3.1 has been modified so that the "fact" nature is removed.

Comment 15: Page 6-42, second paragraph. The USEPA Drinking Water Maximum Contaminant Level (MCL) is characterized as a TBC. The USEPA MCLs are promulgated values that are ARARs, as well as the NYS drinking water standards.

Response 15: Agreed. Section 6.10 and other related sections have been revised to reflect that the MCLs are considered ARARs for the sites.

Comment 16: Page 8-1, Section 8.1.1, SEAD-59, 1st and 2nd Bullets. EPA considers the implementation of institutional controls as a remedy. Therefore, these first two bullets are incorrect in calling the Army's recommendation for these AOCs as No Further Action.

Response 16: Acknowledged. The Army assumes the comment was for Section 8.2 on page 8-3. Section 8.2 has been revised and the reference to No Further Action has been removed.

Comment 17: Page 8-1, Section 8.1.1, SEAD-59, 4th Bullet. The text references alternative risks calculated within the ecological risk assessment, but it is not clear whether this statement refers to risks calculated using mean concentrations of the contaminants of concern as described in the last paragraph of Section 7.6, Further Refinement of Contaminants of Concern, on page 7-23. The term "alternative risk" should be defined.

Response 17: Agreed. The term has been clarified in Section 7 and has been reiterated in Section 8.1.1.

Comment 18: Page 8-3, Section 8.2, Recommendations, 6th Bullet. The text recommends that a Five-Year Review be performed to assess the impacts of PAHs in soil within the Fenced Area of SEAD-71. If the soil within this area warranted a Five-Year Review, it certainly should have been included in the human health and ecological risk assessments presented in the document. Page 6-54 in *A Guide to Preparing Superfund Proposed Plans, Records of Decision, and other Remedy Selection Decision Documents* (USEPA, 1999) outlines Five-Year Review requirements. According to this guidance document, Five-Year Reviews are normally undertaken after a site remedy has been implemented. No Five-Year Review is therefore recommended until after the ROD for SEAD-71 is in place.

Response 18: Agreed. A five-year review will not start until after a ROD is signed for SEAD-71. The reference to five-year review has been removed from the report.

Comment 19: Table 1-1. This table presents background data for the Eastern United States and Albany, NY area. Since a large background study for inorganic compounds in soil at the Seneca Army Depot Activity has already been completed, the information presented in this table is extraneous and the table should be removed.

Response 19: Agreed. Table 1-1 and the associated reference to the Eastern United States and Albany, NY area background data have been removed from the report. The tables in Section 1 have been renumbered accordingly.

Comment 20: Tables 1-2 and 1-3. Add the measured depth to the bottom of the wells to these tables.

Response 20: Agreed. It should be noted that Tables 1-2 and 1-3 have been renumbered as Tables 1-1 and 1-2, respectively. The measured depth to the bottom of the wells has been added to Tables 1-1 and 1-2.

Comment 21: Table 3-1. Section 3.1.2 of the text indicates that the rejected data contained in this table are from the Time Critical Removal Action. This should be stated in the title of the table, or added as a note at the bottom of the table. The addition of sampling dates to the table would also be helpful.

Response 21: Agreed. The title for Table 3-1 has been changed to "Summary of 2002 TCRA Rejected Analytical Results". A footnote has been added to Table 3-1 to state that the rejected data were from the 2002 TCRA. Sample collection date information has been added to Table 3-1.

Army's Response to Comments from the US Environmental Protection Agency

Subject: Draft Phase II Remedial Investigation Report for SEAD-59 & SEAD-71
Seneca Army Depot
Romulus, New York

Comments Dated: February 15, 2006 (via Email)

Date of Comment Response: March 31, 2006

Army's Response to Comments

Comment 1 (Specific Comment 6 in Comment Letter Dated November 16, 2005): We do not accept bringing up SEAD-13 as an excuse to an erroneous risk assessment.

Response 1: Acknowledged. The Army has reconsidered its prior response to Specific Comment 6 in the EPA's November 16, 2005 letter.

To incorporate procedures requested in the prior EPA letter, the COPC screening was repeated using the residential Region IX PRGs corresponding to either a hazard quotient of 0.1 or a cancer risk of 10^{-6} . As shown in the table below, several additional COPCs (mainly metals) are identified using the requested approach.

Additional COPCs By Using 0.1PRGs for PRGs Based on Non-Carcinogenic Effects

Medium	SEAD-59	SEAD-59 Stockpile	SEAD-71 (Outside Fenced Area)
Soil (Surface/Total Soil)	Aluminum Manganese Thallium Vanadium	Aluminum Manganese Thallium Vanadium	2-Methylnaphthalene Naphthalene Aluminum Antimony Manganese Thallium Vanadium
Groundwater	Antimony Iron Manganese Vanadium		Aluminum Antimony Chromium Vanadium

The risk assessment was repeated including all COPCs identified using this screening approach and the risk results are presented in Appendix G of the Draft Final Phase II RI report and summarized as follows:

- In general, the results confirm the conclusion presented in the Draft Phase II RI report that with the restriction of groundwater use and industrial future use at the sites, even the revised list of COPCs identified at the sites do not pose unacceptable risks to potential receptors. There is one exception noted below.
- Elevated non-cancer risks for construction workers via dust inhalation were observed for SEAD-59 and SEAD-71. Aluminum and manganese are the predominant risk contributors to the elevated risks. Statistical analysis (both non-parametric Mann-Whitney T Test and parametric Student's T Test) concludes that aluminum and manganese concentrations at the sites are not statistically above background.

Detailed discussion of the revised risk results is presented in Section 6.8 (Uncertainty Analysis) of the Draft Final Phase II RI report. With the exception of Section 6.8, and as discussed with USEPA on March 9, 2006 (meeting minutes attached), the risk assessment discussion was not revised based on the above analysis.

Comment 2 (Specific Comment 7 in Comment Letter Dated November 16, 2005): This is a deviation to the Action Memorandum and Workplan, and is unacceptable.

Response 2: Acknowledged. The purpose of the 2002 TCRA was to remove debris and any impacted soils from the sites. In removing and locating debris from the sites, excess soil was removed during the process. Sampling of stockpiles aided in the determination of which soils should be removed from the sites and which should remain on-site. In some instances, all cleanup goals were not met in every stockpile sample, the Army believed that the best forward approach was to evaluate whether the soil contained in the stockpiles posed unacceptable risk. The Army does not believe that soil stockpiles that do not cause risk under the future use scenario should be disposed offsite. The Army proceeded with the risk assessment as part of this RI and the results are summarized below:

- The stockpiles do not pose any unacceptable risks to human health or the environment under the industrial use scenario;
- The average BAP equivalency for carcinogenic PAHs was approximately 8 mg/kg, which is below the NYSDEC screening value of 10 mg/kg;
- Although SEAD-59/71 is planned for future industrial development, risks for potential residents via exposure to stockpile soil were evaluated for screening purposes. Non-cancer risk was slightly above the EPA limit (2 vs. 1) for a residential child; the elevated risk was caused by intake of groundwater at SEAD-59. If groundwater use restriction were in place, the noncancer risk for the child resident with exposure to SEAD-59 stockpiles would be below the USEPA limit. Total cancer risk for a residential receptor is slightly above the EPA limit (2E-4 vs. 1E-4) under the reasonable maximum exposure (RME) scenario. When more realistic central tendency (CT) assumptions are used, the total cancer risk is below the EPA limit (8E-5 vs. 1E-4). In

summary, under a more realistic CT assumption, the stockpiles at SEAD-59 do not pose unacceptable risks to the residential receptor.

Based on the above facts, it is the Army's position that the stockpiles can be used as fill or grading material.

Comment 3 (Specific Comment 9 in Comment Letter Dated November 16, 2005): We disagree with the response. The adolescent trespasser is the most realistic receptor.

Response 3: Acknowledged. The Army believes it is a conservative step to evaluate a child receptor. In addition, the child trespasser is also used in this RI to evaluate potential future receptor such as child visitor. Nonetheless, an adolescent receptor (i.e., 11-16 yr old) has been evaluated and the risk results are presented in Appendix G and summarized in Section 6.8 (Uncertainty Analysis) of the Draft Final Phase II RI report.

The 14 days/year exposure frequency was selected based on best professional judgment and site-specific conditions. The Depot is situated in a sparsely populated rural area; it is fenced to limit access and is occasionally patrolled by site security personnel. SEAD-59 and SEAD-71 are both located in close proximity to the Army's current office locations (within 500 feet), and both are typified as relatively open and generally flat. Further, the setting of SEAD-59/71 is generally similar to the surrounding areas and there are no areas that may attract special attention from potential adolescent trespassers. Therefore, trespassing at SEAD-59/71 is considered unlikely to occur frequently or for extended periods without individuals being challenged or noticed. On this basis, a 14 days/year exposure frequency is considered a reasonable assumption for the sites. Nonetheless, an elevated exposure frequency (50 days/year) was evaluated and this evaluation indicates that no unacceptable risks are expected for SEAD-59/71. Although elevated non-cancer risk was observed at SEAD-71 for the trespasser, the elevated hazard index is mainly caused by groundwater intake, which contributes 97% of the total risk. If groundwater use restriction were in place, the risks for the adolescent trespasser with exposure frequency of 50 days/year would be below the USEPA limits via exposure to COPCs in SEAD-71 soil and groundwater outside the Fenced Area. Detailed discussion is presented in Section 6.8 (Uncertainty Analysis) of the Draft Final Phase II report.

Comment 4 (Specific Comment 10 in Comment Letter Dated November 16, 2005): The response is unacceptable. EPA Region 2 does not use bioavailability.

Response 4: Although the Army does not agree that bioavailability factors should not be used, the risk assessment was reevaluated using a bioavailability factor of 1. The revised risk results using the default bioavailability of 1 are presented in Appendix G of the Draft Final Phase II report and a discussion of the

results is presented in Section 6.8 (Uncertainty Analysis). Using the default bioavailability of 1 does not change the overall risk assessment conclusion for these sites.

Army's Response to Comments from the New York State Department of Environmental Conservation

Subject: Draft Phase II Remedial Investigation Report
SEAD-59 and SEAD-71
Seneca Army Depot
Romulus, New York

Comments Dated: January 30, 2006

Date of Comment Response: February 03, 2006

Army's Response to Comments

SPECIFIC COMMENTS

Comment 1: Executive Summary, Page E-10, Section E-5

The State of New York considers the implementation of Institutional Controls as a remedy. Revise the 1st and 2nd Bullets from "No Further Action" in the text.

Response 1: Agreed. Section E-5 and Section 8.2 have been revised and the reference to No Further Action has been removed.

Comment 2: Page E-11, 3rd Bullet from Top of Page

"...conduct a 5-year review on SEAD 71..." specify the starting date for the 5-year period. Is it the ROD date or the date ICs are put in place?

Response 2: A five-year review will not start until after the ROD is signed. The reference to 5-year review has been removed from the report.

Comment 3: Page 7-38, Section 7.8

The Army's position is "...soil at SEAD-59/71 and in SEAD-59 Stockpiles is not expected to significantly impact ecological receptors at the site and no further action is warranted at SEAD-59/71 based on the ecological risk assessment." The State agrees with the Army's conclusion.

Response 3: Acknowledged.

Comment 4: Page 2-9, Confirmatory Samples

Confirmation sample designations of WN# and WW# are defined identically. Is this accurate? Clarification is requested.

Response 4: Acknowledged. The definition for WW# has been revised to refer to perimeter sample from the west wall of the excavated area.

Comment 5: Page 8-1, Section 8.1.2

I understand that hay bales have been placed around stockpiled soil at SEAD-59 to mitigate run-off water and DOH has concerns that they have visibly deteriorated since their placement. Are there any plans for replacement of these hay bales or evaluation of soils around the stockpile footprint to determine if any migration of contaminants from the stockpile has occurred?

Response 5: Acknowledged. Based on the following factors, it is the Army's position that stockpiles at SEAD-59 do not pose potential risks to human health, the environment, or the surrounding soil/groundwater conditions. Therefore, potential contaminant migration is negligible and evaluation of potential migration or hay bale replacement is not warranted. The stockpile soil at SEAD-59 is suitable for use as fill or grading material.

- No VOC, pesticide, or PCB concentrations in stockpile samples were above the NYSDEC TAGM values.
- With the exception of seven carcinogenic PAHs, no SVOC concentrations exceeded the NYSDEC TAGM values in the stockpile samples.
- The average carcinogenic PAH Benzo(a)pyrene Toxicity Equivalent (BTE) concentration for the stockpile samples is 8.1 mg/kg, below the cleanup goal for carcinogenic PAHs used at SEAD-11 (per NYSDEC comments on the Action Memorandum for SEAD-11 dated January 26, 2004).
- Concentrations detected for several metals exceeded the NYSDEC TAGM values; however, the metal concentrations in stockpiles were generally consistent or below the metal concentrations detected in SEAD-59 soil.
- Human health risks are within the USEPA acceptable ranges for receptors evaluated and no further action is warranted for the SEAD-59 stockpile soils to mitigate potential risks to ecological receptors.
- Although SEAD-59/71 is planned for future industrial development, risks for potential residents via exposure to stockpile soil were evaluated for screening purposes. Non-cancer risk was slightly above the EPA limit (2 vs. 1) for a residential child; the elevated risk was caused by intake of groundwater at SEAD-59. If groundwater use restriction were in place, the noncancer risk for the child resident with exposure to SEAD-59 stockpiles would be below the USEPA limit. Total cancer risk for a residential receptor is slightly above the EPA limit (2E-4 vs. 1E-4) under the reasonable maximum exposure (RME) scenario. When more realistic central tendency (CT) assumptions are used, the total cancer risk is below the EPA limit (8E-5 vs. 1E-4). In summary, under a more realistic CT assumption, the stockpiles at SEAD-59 do not pose unacceptable risks to the residential receptors.

Comment 6: DEC understands that other issues already covered by USEPA comments on November 16, 2005 will be appropriately addressed by the Army.

Response 6: Acknowledged. The USEPA comments dated November 16, 2005 have been addressed and the Draft Final report has been revised to incorporate both the USEPA and NYSDEC comments.

Draft Phase II RI Report for SEAD-59 and SEAD-71
 Contract: DACA87-02-D-0005

DESIGN REVIEW COMMENTS

PROJECT

- | | | | |
|--|--|---|--------------------------------------|
| <input type="checkbox"/> SITE DEV & GEO | <input type="checkbox"/> MECHANICAL | <input type="checkbox"/> SAFETY | <input type="checkbox"/> SYSTEMS ENG |
| <input checked="" type="checkbox"/> ENVIR PROT& UTIL | <input type="checkbox"/> MFG TECHNOLOGY | <input type="checkbox"/> ADV TECH | <input type="checkbox"/> VALUE ENG |
| <input type="checkbox"/> ARCHITECTURAL | <input type="checkbox"/> ELECTRICAL | <input type="checkbox"/> ESTIMATING | <input type="checkbox"/> OTHER |
| <input type="checkbox"/> STRUCTURAL | <input type="checkbox"/> INST & CONTROLS | <input type="checkbox"/> SPECIFICATIONS | |

REVIEW Project Support
 DATE 13 April, 2006
 NAME C. King, ED-CS-P (256/895-1843)

ITEM	DRAWING NO. OR REFERENCE	COMMENT	ACTION
1.	GENERAL	I have reviewed the Draft Phase II RI Report for SEAD-59 and SEAD-71 at Seneca Army Depot. The document is well-written, and I concur with the NOFA recommendation for these sites. I have two minor comments/suggestions below.	NA
2.	Section 2.2.2.1, Fourth Paragraph on Page 2-3	In the fourth paragraph of Section 2.2.2.1 it states that groundwater at SEAD-59 has been moderately impacted by TPHs, and that TPHs were detected at low concentrations in each of the downgradient water samples. Suggest elaborating more on these statements by either listing the maximum TPH concentration detected or a range of the concentrations that were detected in groundwater, and stating at the beginning of the paragraph that TPH concentrations in groundwater do not exceed NYSDEC standards.	Acknowledged. Discussion of TPH results in SEAD-59 groundwater has been added to Section 2.2.2.1. It should be noted that there are no NYSDEC standards or guidance values available for TPH. Detailed discussion of nature and extent of impacts can also be found in Section 4.
3.	Section 2.3.2.2, First Paragraph on Page 2-7	The first paragraph on Page 2-7 states that surface soils within the Fenced Area appear to be impacted by the presence of pesticides and TPH. Suggest elaborating on the concentrations of these constituents, such as the range of concentrations detected, and whether or not they are near TAGM values.	Acknowledged. Discussion of TPH, PAH, and pesticide results has been added to Section 2.3.2.2. Detailed discussion of nature and extent of impacts can also be found in Section 4.

ACTION CODES
 A - ACCEPTED/CONCUR W - WITHDRAWN
 D - ACTION DEFERRED N - NON-CONCUR
 VE - VE POTENTIAL/VEP ATTACHED